

Datasheet

Pan Head Machine Screw

RS Stock number: 483-0940

Dimensions(mm):

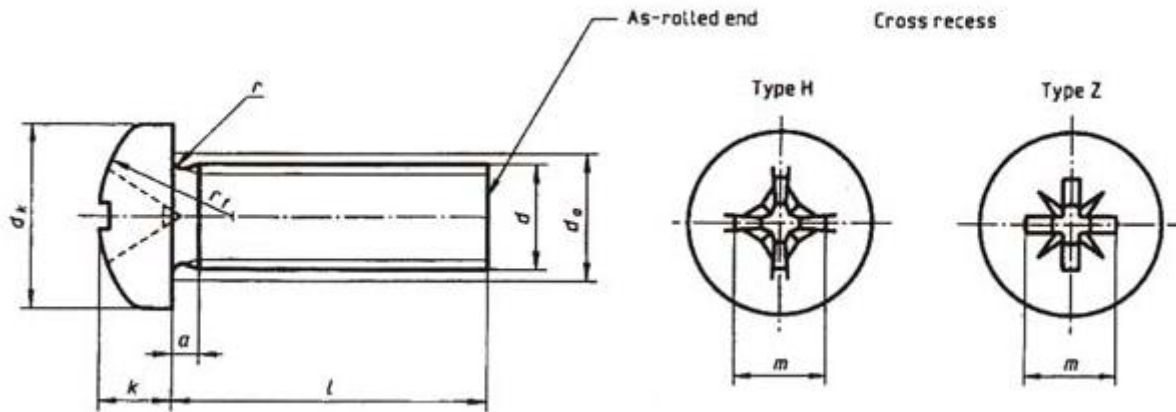

Size	M2	M3	M4	M5	M6	M8
$m \approx$	2.5	3.1	4.6	5.3	6.8	9
R1	4	6	8	10	12	16
a max.	-	1	1.4	1.6	2	2.5
$v \approx$	1.1	1.6	2	2.5	3	3.7
k	1.6	2.4	3.1	3.8	4.6	6
d1 max.	4	6	8	10	12	16