

Datasheet

Stock No: 286-3522

RS Pro Round Tube Single Swivel Combination, strut profile Type 1



Product Details

Single Swivel Combination

Allows the connection of a tube to a through tube between an angular range of 170°

Generally used as an end fitting on stair cases where flexibility is required in the gradient of the handrail

Dimensions (mm)		
Tube Size Ref.	F	G
1	42	60
2	47	64
3	50	70

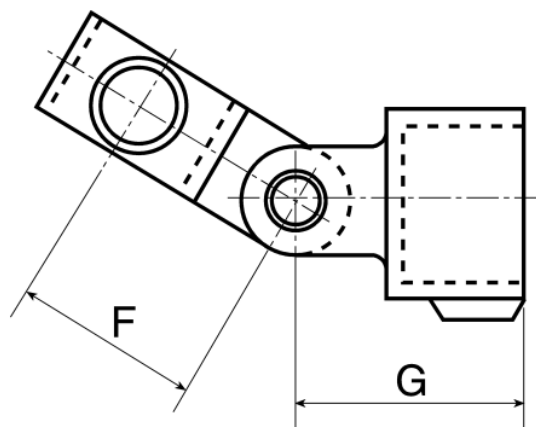



Specifications:

Structural Element Type	Round Tube
Connector Type	Single Swivel Combination
Fits Strut Profile	Type 1
Fits Tube Diameter	33.7mm
Product Family	RS Handrail System
Material	Cast Iron
Product System	173

Staircase Fittings

The line drawing illustrates some typical applications of the fittings for the construction of staircase handrails.

For Tube Size Refs. 1, 2 and 3.

The 'selection guide' table links the alphabetical key in the illustration to the specific fittings (a typical stock number is also quoted).

Selection Guide		
Key	Fitting Description	Typical Stock No.
H	90° Elbow	286-3370
M	Rail Base Flange	286-3623
Q	Single Mesh Panel Clip	415-7037
S	Handrail bracket	286-3689
T	Single swivel combination	286-3522
U	Double swivel combination	286-3544
V	Variable elbow 15° to 60°	415-5968
W	Adj. Short tee 30° to 60°	415-6006
X	Two socket cross adj. 30° to 45°	415-6034
Y	Short tee swivel	415-6191
Z	Plastic stop end	286-3718

Note

The 'selection guide' table links the alphabetical key in the illustration to the specific fittings (a typical stock number is also quoted).