

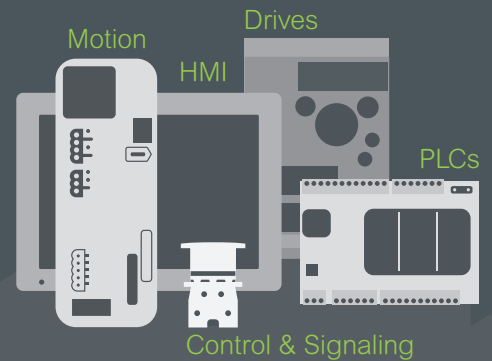

Introducing the **Easy Series**

Essential automation & control products

When just enough is just right!



Easy Altivar 610

Variable speed drives

Drives for pumps and fans from 0.75 to 250 kW

Quick access to product information

Get technical information about your product

References

Modicon TM3
I/O expansion modules for Modicon controllers
Analog I/O modules

References	Modicon TM3 analog input modules	Input range	Resolution	Input terminal block (T)	Reference	Weight (kg)
2 voltage/current inputs	-10...+10 VDC 0...+10 VDC 0...20 mA / -20 mA	16 bits	16 bits	0 580.2	TM3AI20	0.150
		12 bits	12 bits	0 580.2	TM3AI12	0.150
4 voltage/current inputs	-10...+10 VDC 0...+10 VDC 0...20 mA / -20 mA	12 bits	12 bits	3 810.15	TM3AI4	0.200
		16 bits	16 bits	3 810.15	TM3AI8	0.200
4 voltage/current or temperature inputs (I, K, R, S, E, T, N, E, C)	-10...+10 VDC 0...+10 VDC 0...20 mA / -20 mA	12 bits	12 bits	3 810.15	TM3AI4	0.200
		16 bits	16 bits	3 810.15	TM3AI8	0.200
4 differential temperature inputs (I, K, R, S, E, T, N, E, C)	-10...+10 VDC 0...+10 VDC 0...20 mA / -20 mA	12 bits	12 bits	3 810.15	TM3AI4	0.200
		16 bits	16 bits	3 810.15	TM3AI8	0.200

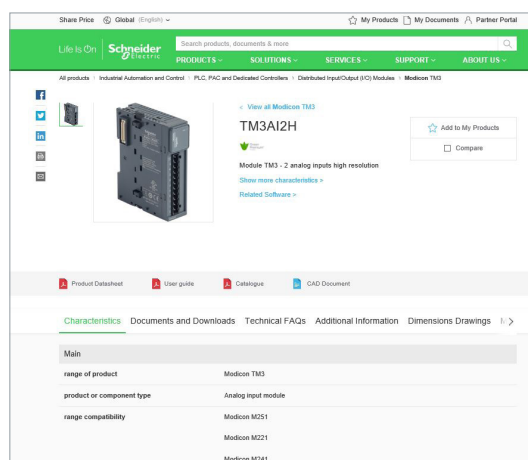

Each commercial reference presented in a catalog contains a hyperlink. Click on it to obtain the technical information of the product:

- Characteristics, Dimensions and drawings, Mounting and clearance, Connections and schemas, Performance curves
- Product image, Instruction sheet, User guide, Product certifications, End of life manual

Find your catalog

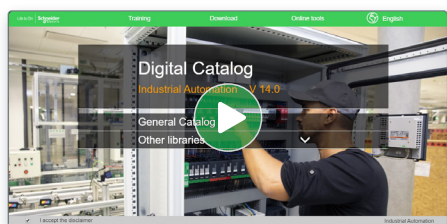

- > With just 3 clicks, you can access the Industrial Automation and Control catalogs, in both English and French
- > Consult digital automation catalogs at [Digi-Cat Online](#)

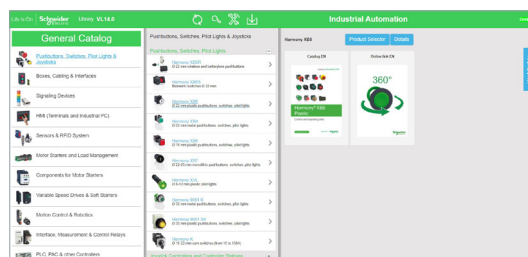

- Up-to-date catalogs
- Embedded product selectors, 360° pictures
- Optimized search by commercial references

Select your training



- > Find the right [Training](#) for your needs on our Global website
- > Locate the training center with the selector tool, using this [link](#)

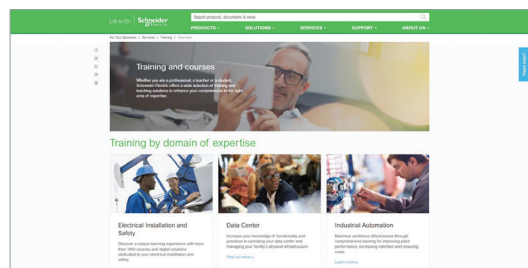

Life Is On

Schneider Electric

mySchneider, your personalized digital experience

Access an all-in-one customized online experience and benefit from tailored business services, resources, and tools to efficiently support your business operations.

- **Efficiency:** In just a few clicks, find all the information and support you need to get the job done.
- **Simplicity:** Use a single login to access all business services, in one place, available 24/7. You no longer need to log in to multiple platforms.
- **Personalization:** Benefit from content, tools, and business services tailored to your activity, and customize your landing page based on your preferences.

Watch the How-to Videos



Order management

- > [Select Products and Add to Cart](#)
- > [Check for Products' Price and Availability](#)
- > [Order Products with Generic Commercial References](#)



Product information

- > [Find a Product Data Sheet and Related Documents](#)
- > [Select Products and Add to Cart](#)
- > [Stay Up to Date on the Status of My Products](#)



Support

- > [Get Quicker Answers Thanks to Online Support](#)

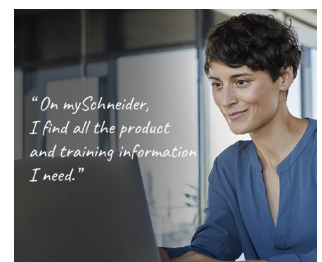

Training

- > [Access Trainings Dedicated to My Activity](#)

[Create your account](#)

Life Is 

Schneider
Electric



Altivar

Discover [Altivar](#)

Variable speed drives and soft starters

Improve your energy efficiency and sustainability with Altivar variable speed drives and soft starters. Manage motor control applications up to 20 MW with products ranging from compact products to custom-engineered solutions. Our connected devices offer built-in intelligence to improve operational efficiency, availability, and functional safety in various application areas, such as industrial processes, machines, or buildings.

Explore our offer

- [Altivar Process](#)
- [Altivar Machine](#)
- [Altivar Building](#)
- [Altivar Soft Starters](#)
- [Altivar Industry-Specific Drives](#)

Life Is 

Schneider
Electric

General contents

Easy Altivar 610 variable speed drives

■ Variable speed drives

- Presentation [page 2](#)
- Normal duty and Heavy duty operating modes [page 4](#)
- Integrated functions [page 4](#)
- Configuration and runtime tools [page 5](#)
- Accessories and options [page 5](#)
- References of drives and accessories [page 6](#)

■ Configuration and runtime tools

- Plain text display terminal [page 10](#)
- Door mounting kit for plain text display terminal [page 11](#)

■ Options

- Integrated I/O and I/O option modules [page 12](#)
- Integrated ports and communication protocol [page 13](#)
- PROFIBUS DP communication module [page 14](#)
- Passive filters [page 15](#)
- dv/dt filters [page 16](#)

■ Motor starters combinations [page 17](#)

■ Drives and fuses combinations [page 18](#)

■ Dimensions [page 19](#)

■ Product reference index [page 22](#)



Water & wastewater



Oil & gas



Circulating pumps for building management

Introduction to the offer: applications

The Easy Altivar 610 drive is an IP20 frequency inverter for three-phase asynchronous motors and synchronous motors (up to 160 kW/216 HP), specially designed for standard applications in the following market segments and domains:

Market segments



Water & wastewater



Oil & gas

Domains



Process & machine management



Building management

Typical applications in the market segments

Water & wastewater

- Intake pump
- Booster pump
- Lifting pump
- Aeration blower

Oil & gas

- Circulating pump
- Drain pump
- Oil transfer pump

Pump and fan applications in the domains

Process & machine management

- Air cooling system fan
- Circulating pump
- Cooling fan
- Draft fan
- Compressor
- Conveyor

Building management

- Fan
- Circulating pump



ATV610U07N4...U75N4

ATV610D11N4...D15N4



ATV610D18N4...D22N4

ATV610D30N4...D45N4



ATV610D55N4...D90N4

ATV610C11N4...C16N4



Presentation of the offer

The Easy Altivar 610 offer covers motor power ratings from 0.75 to 250 kW/1 to 400 HP for three-phase voltages between 380 and 460 V.

Easy Altivar 610 drives can help improve equipment performance and reduce operating costs by optimizing energy consumption and user comfort.

A communication module is available for seamless integration into the main automation architectures.

Easy Altivar 610 drives feature various configurable I/O as standard to facilitate adaptation to specific applications.

They offer a plug & play solution whereby parameters are preset in the factory to the desired configuration to help save process control and operating time.

Rugged

Easy Altivar 610 drives are robust products designed to adapt to various levels of thermal stress and to harsh environments.

- Operating temperature (for continuous monitoring):
 - Mounting in enclosure; mounted singly or side-by-side:
 - For ATV610U07N4...C16N4 and N4Z products: -15...+60 °C/+5...+140 °F, 45...60 °C/113...140 °F with derating
 - For size 7 products ATV610C22N4...C25N4: -10...+60 °C/+14...+140 °F, 40...60 °C/104...140 °F with derating
 - Storage and transport temperature: -40...+70 °C /-104...+158 °F
 - Operating altitude:
 - 0...1,000 m/0...3,281 ft without derating
 - 1,000...4,800m/3,281 ft...15,748 ft with derating of 1% per 100 m/328 ft
 - Chemical class 3C3 conforming to IEC/EN 60721
 - Dust pollution resistance class 3S3 conforming to IEC/EN 60721
 - ATV610C22N4...C25N4 drives are certified as chemical class 3C2 and mechanical class 3S2 conforming to IEC/EN 60721
 - Electronic cards with protective coating
 - Protection to suit requirements:
 - IP20 for mounting in enclosure
 - IP40 on the top of the product (with top cover)
 - IP43 for remote display terminal

Electromagnetic compatibility (EMC)

Compliance with electromagnetic compatibility requirements has been incorporated into the design of the drive, which simplifies installation and provides an economical means of helping to ensure equipment meets CE marking requirements.

Easy Altivar 610 drives have a category C3 EMC filter (see page 4).

Installation and maintenance

Easy Altivar 610 drives are ergonomically designed to adapt to any type of installation:

- Products, systems, or integrated in IMCC
- IP20
- Easy installation of products and systems:
 - Cable entry equipped with Romex cable glands to maintain an EMC connection for the power and control cable
 - Color code for connections to the display terminal and control terminals
- Asynchronous motors and synchronous motors (up to 160 kW/216 HP) drive in open loop for 0.1...500 Hz output frequency
- Lower maintenance costs:
 - Fans can be replaced in less than 5 minutes
 - No maintenance tool required
 - Limited number of parts

Green product

Easy Altivar 610 drives have been designed to have a smaller carbon footprint: the Green Premium product label, Schneider Electric's eco-mark, indicates compliance with international environmental standards such as:

- RoHS according to European Directive 2011/65 and the Commission Delegated Directive (EU) 2015/863
- REACH according to EU regulation 1907/2006
- IEC 62635: The end-of-life instructions comply with the latest recycling rules, 85% of the product components can be recycled.

Variable speed drives

Easy Altivar 610

Operating modes and integrated functions

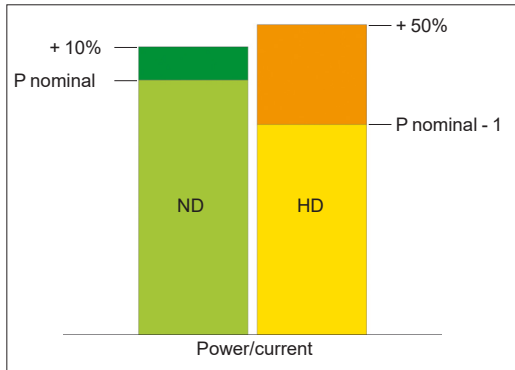

Normal duty and Heavy duty modes

Normal duty and Heavy duty operating modes

The Easy Altivar 610 offer covers motor power ratings from 0.75...250 kW/1...400 HP for three-phase voltages between 380 and 460 V.

Three-phase power supply	Motor power	Degree of protection	Reference
380...460 V	0.75 kW...250 kW 1...400 HP	IP20	ATV610U07N4...C25N4

Easy Altivar 610 variable speed drives are designed for use in two operating modes that can optimize the drive nominal rating according to the system constraints.

These two modes are:

- Normal duty (ND): Dedicated mode for applications requiring a slight overload (up to 110% for 60 s or 120% for 20 s) with a motor power no higher than the drive nominal power
- Heavy duty (HD): Dedicated mode for applications requiring a significant overload (up to 150% for 60 s) with a motor power no higher than the drive nominal power derated by one rating

These two operating modes make the Easy Altivar 610 range suitable for use in variable and constant torque applications, such as pump, fan, compressor, and conveyor.

Integrated functions

Integrated DC chokes

Above 4 kW/5 HP, Easy Altivar 610 variable speed drives are supplied with an integrated DC choke to reduce harmonic distortion.

Integrated EMC filters

Easy Altivar 610 drives have integrated radio interference input filters in accordance with the EMC standard for variable speed electrical power drive "products" IEC/EN 61800-3, edition 2, category C3 in environment 1 or 2, and to comply with the European EMC (electromagnetic compatibility) directive.

Maximum length of shielded cable (1) according to IEC/EN 61800-3, category C3: 50 m/164 ft (for all ratings).

The integrated EMC filter creates leakage current to ground. It is possible to reduce the leakage current by removing the filter capacitors (see the diagrams on our website or refer to the [Installation Manual](#)). In this configuration, the product does not meet the EMC requirements according to standard IEC 61800-3.

Communication protocol

The Modbus serial link allows the connection of configuration and runtime tools via two integrated ports.

(1) Values given depend on the nominal switching frequency of the drive. This frequency depends on the drive rating. If motors are connected in parallel, it is the total length of all cables that should be taken into account.

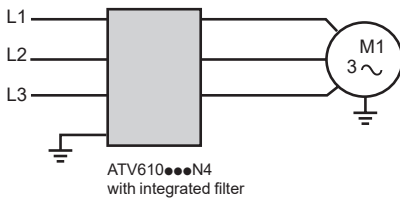

Easy Altivar 610 drive with integrated EMC filter

Configuration and runtime tools

Easy Altivar 610 drives can be supplied with a plain text display terminal (see [page 10](#)), offering the following functions:

- Drive control, adjustment, and configuration
- Display of current values (motor, I/O, etc.)
- Configuration storage and download
- Duplication of one drive configuration on another drive
- Remote use by means of appropriate accessories (see [page 11](#))
- Read/write values

Accessories and options

Accessories

Easy Altivar 610 drives are designed to take complementary accessories to increase their functionality.

- Plain text display terminal:
- Kit for mounting on enclosure door (see [page 11](#))

Options

Easy Altivar 610 integrates a certain number of I/O as standard (see [page 12](#)).

The following options can be added:

- Modules:
 - Extended I/O module (see [page 12](#)):
 - 2 analog inputs configurable as voltage, current, or probe
 - 6 discrete inputs
 - 2 discrete outputs
 - Extended relay module (see [page 12](#)):
 - 3 relay NO discrete outputs
 - Communication module (see [page 14](#)):
 - Profibus DP V1 bus
- Passive filters (see [page 15](#))
- Output filters:
 - dv/dt filters (see [page 16](#))

Motor starters

Schneider Electric offers combinations of circuit breakers and contactors to be able to use Easy Altivar 610 drives in optimum conditions (see [page 17](#)).

PF140391C



Extended I/O module

Variable speed drives

Easy Altivar 610

Supply voltage 380...460 V 50/60Hz with keypad



ATV610U07N4



ATV610D18N4

IP20 three-phase 380...460 V drives with integrated category C3 EMC filter										
Motor			Power supply to the power section				Easy Altivar 610			
Nominal power indicated on rating plate (1)			Max. input current (2)		Apparent power	Max. prospective line Isc	Maximum continuous current (1)	Maximum transient current for 60 s	Reference	Weight
			380 V	460 V	460 V					
ND: Normal duty (3)										
HD: Heavy duty (4)										
	kW	HP	A	A	kVA	kA	A	A		kg/lb
ND	0.75	1	3.1	2.6	2.1	5	2.2	2.4	ATV610U07N4	3.135/6.9
HD	0.37	0.5	1.7	1.4	1.1	5	1.5	2.3		
ND	1.5	2	5.7	4.8	3.8	5	4	4.4	ATV610U15N4	3.135/6.9
HD	0.75	1	3.1	2.6	2.1	5	2.2	3.3		
ND	2.2	3	7.8	6.5	5.2	5	5.6	6.2	ATV610U22N4	3.135/6.9
HD	1.5	2	5.6	4.6	3.7	5	4	6		
ND	3	–	10.1	8.4	6.7	5	7.2	7.9	ATV610U30N4	3.135/6.9
HD	2.2	3	7.6	6.4	5.1	5	5.6	8.4		
ND	4	5	8.8	7.9	6.3	5	9.3	10.2	ATV610U40N4	4.045/8.9
HD	3	–	7.2	6.2	4.9	5	7.2	10.8		
ND	5.5	7.5	11.6	10.5	8.4	22	12.7	14	ATV610U55N4	4.575/10
HD	4	5	8.9	7.9	6.3	22	9.3	14		
ND	7.5	10	14.7	12.8	10.2	22	15.8	17.4	ATV610U75N4	4.575/10
HD	5.5	7.5	11.3	10.2	8.1	22	12.7	19.1		
ND	11	15	22	19.6	15.6	22	23.5	25.9	ATV610D11N4	7.73/17
HD	7.5	10	16.4	14.6	11.6	22	16.5	24.8		
ND	15	20	29.4	26	20.7	22	31.7	34.9	ATV610D15N4	7.73/17
HD	11	15	23	20.8	16.6	22	23.5	35.3		
ND	18.5	25	37.2	33.5	26.7	22	39.2	43.1	ATV610D18N4	13.5/29.8
HD	15	20	31.6	28.3	22.6	22	31.7	47.6		
ND	22	30	41.9	36.2	28.8	22	46.3	50.9	ATV610D22N4	13.5/29.8
HD	18.5	25	36	31.6	25.2	22	39.2	58.8		
ND	30	40	62.5	55.8	44.5	22	61.5	67.7	ATV610D30N4	25.5/56.2
HD	22	30	49.7	42.5	33.8	22	46.3	69.5		
ND	37	50	76.6	68.3	54.4	22	74.5	82	ATV610D37N4	25.5/56.2
HD	30	40	65.8	56.8	45.2	22	59.6	89.4		

(1) These values are given for a nominal switching frequency of 4 kHz up to **ATV610D45N4**, or 2.5 kHz for **ATV610D55N4...C25N4** for use in continuous operation.

The switching frequency is adjustable from 2...12 kHz up to **ATV610D45N4**, or from 1...8 kHz for **ATV610D55N4...C25N4**. Above 2.5 or 4 kHz (depending on the rating), the drive will automatically reduce the switching frequency in the event of an excessive temperature rise. For continuous operation above the nominal switching frequency, derate the nominal drive current (see the derating curves in the [Installation Manual](#)).

(2) Typical value for the indicated motor power and for the maximum prospective line Isc.

(3) Values given for applications requiring a slight overload (up to 110% for 60 s or 120% for 20 s).

(4) Values given for applications requiring a slight overload (up to 150% for 60 s).



ATV610C11N4



ATV610C22N4

IP20 three-phase 380...460 V drives with integrated category C3 EMC filter (continued)

Motor	Power supply to the power section						Easy Altivar 610		Reference	Weight
	Nominal power indicated on rating plate (1)	Max. input current (2)		Apparent power	Max. prospective line Isc	Maximum continuous current (1)	Maximum transient current for 60 s			
		380 V	460 V					460 V		
ND: Normal duty (3)										
HD: Heavy duty (4)										
	kW	HP	A	A	kVA	kA	A	A		kg/lb
ND	45	60	92.9	82.7	65.9	22	88	97	ATV610D45N4	25.5/56.2
HD	37	50	80.5	69.6	55.4	22	74.5	112		
ND	55	75	111.5	99.7	79.5	22	120	132	ATV610D55N4	53/117
HD	45	60	95.9	84	66.9	22	88	132		
ND	75	100	147.9	130.2	103.7	22	145	160	ATV610D75N4	53/117
HD	55	75	115.8	101.7	81	22	106	159		
ND	90	125	177.8	159.9	127.4	50	173	190	ATV610D90N4	53/117
HD	75	100	155.8	138.1	110	50	145	218		
ND	110	150	201	175.7	140	50	211	232	ATV610C11N4	85.5/188.5
HD	90	125	170	149.1	118.8	50	173	260		
ND	132	200	237	203.8	162.4	50	250	275	ATV610C13N4	85.5/188.5
HD	110	150	201	174.2	138.7	50	211	317		
ND	160	250	284	249.5	198.8	50	302	332	ATV610C16N4	85.5/188.5
HD	132	200	237	205.9	164	50	250	375		
ND	220	350	397	341	272	50	427	470	ATV610C22N4	173/381
HD	160	250	296	258	206	50	302	453		
ND	250	400	451	383	305	50	481	529	ATV610C25N4	173/381
HD	200	300	365	313	249	50	370	555		

(1) These values are given for a nominal switching frequency of 4 kHz up to **ATV610D45N4**, or 2.5 kHz for **ATV610D55N4...C25N4** for use in continuous operation.

The switching frequency is adjustable from 2...12 kHz up to **ATV610D45N4**, or from 1...8 kHz for **ATV610D55N4...C25N4**. Above 2.5 or 4 kHz (depending on the rating), the drive will automatically reduce the switching frequency in the event of an excessive temperature rise. For continuous operation above the nominal switching frequency, derate the nominal drive current (see the derating curves in the [Installation Manual](#)).

(2) Typical value for the indicated motor power and for the maximum prospective line Isc.

(3) Values given for applications requiring a slight overload (up to 110% for 60 s or 120% for 20 s).

(4) Values given for applications requiring a slight overload (up to 150% for 60 s).

Variable speed drives

Easy Altivar 610

Supply voltage 380...460 V 50/60Hz without keypad



ATV610U07N4Z



ATV610D11N4Z



ATV610D18N4Z

IP20 three-phase 380...460 V drives with integrated category C3 EMC filter										
Motor			Power supply to the power section				Easy Altivar 610			
Nominal power indicated on rating plate (1)	kW	HP	Max. input current (2)		Apparent power 460 V	Max. prospective line Isc	Maximum continuous current (1)	Maximum transient current for 60 s	Reference	Weight
			380 V	460 V						
ND: Normal duty (3)										
HD: Heavy duty (4)										
			A	A	kVA	kA	A	A		kg/lb
ND	0.75	1	3.1	2.6	2.1	5	2.2	2.4	ATV610U07N4Z	2.985/6.58
HD	0.37	0.5	1.7	1.4	1.1	5	1.5	2.3		
ND	1.5	2	5.7	4.8	3.8	5	4	4.4	ATV610U15N4Z	2.985/6.58
HD	0.75	1	3.1	2.6	2.1	5	2.2	3.3		
ND	2.2	3	7.8	6.5	5.2	5	5.6	6.2	ATV610U22N4Z	2.985/6.58
HD	1.5	2	5.6	4.6	3.7	5	4	6		
ND	3	-	10.1	8.4	6.7	5	7.2	7.9	ATV610U30N4Z	2.985/6.58
HD	2.2	3	7.6	6.4	5.1	5	5.6	8.4		
ND	4	5	8.8	7.9	6.3	5	9.3	10.2	ATV610U40N4Z	3.885/8.565
HD	3	-	7.2	6.2	4.9	5	7.2	10.8		
ND	5.5	7.5	11.6	10.5	8.4	22	12.7	14	ATV610U55N4Z	4.415/9.73
HD	4	5	8.9	7.9	6.3	22	9.3	14		
ND	7.5	10	14.7	12.8	10.2	22	15.8	17.4	ATV610U75N4Z	4.415/9.73
HD	5.5	7.5	11.3	10.2	8.1	22	12.7	19.1		
ND	11	15	22	19.6	15.6	22	23.5	25.9	ATV610D11N4Z	7.540/16.62
HD	7.5	10	16.4	14.6	11.6	22	16.5	24.8		
ND	15	20	29.4	26	20.7	22	31.7	34.9	ATV610D15N4Z	7.540/16.62
HD	11	15	23	20.8	16.6	22	23.5	35.3		
ND	18.5	25	37.2	33.5	26.7	22	39.2	43.1	ATV610D18N4Z	13.300/29.32
HD	15	20	31.6	28.3	22.6	22	31.7	47.6		
ND	22	30	41.9	36.2	28.8	22	46.3	50.9	ATV610D22N4Z	13.300/29.32
HD	18.5	25	36	31.6	25.2	22	39.2	58.8		
ND	30	40	62.5	55.8	44.5	22	61.5	67.7	ATV610D30N4Z	25.295/55.77
HD	22	30	49.7	42.5	33.8	22	46.3	69.5		
ND	37	50	76.6	68.3	54.4	22	74.5	82	ATV610D37N4Z	25.295/55.77
HD	30	40	65.8	56.8	45.2	22	59.6	89.4		
ND	45	60	92.9	82.7	65.9	22	88	97	ATV610D45N4Z	25.295/55.77
HD	37	50	80.5	69.6	55.4	22	74.5	112		
ND	55	75	111.5	99.7	79.5	22	120	132	ATV610D55N4Z	52.045/114.7
HD	45	60	95.9	84	66.9	22	88	132		
ND	75	100	147.9	130.2	103.7	22	145	160	ATV610D75N4Z	52.045/114.7
HD	55	75	115.8	101.7	81	22	106	159		
ND	90	125	177.8	159.9	127.4	50	173	190	ATV610D90N4Z	52.045/114.7
HD	75	100	155.8	138.1	110	50	145	218		
ND	110	149	201	175.7	140	50	211	232	ATV610C11N4Z	85.445/188.4
HD	90	125	170	149.1	118.8	50	173	260		
ND	132	178	237	203.8	162.4	50	250	275	ATV610C13N4Z	85.445/188.4
HD	110	149	201	174.2	138.7	50	211	317		
ND	160	216	284	249.5	198.8	50	302	332	ATV610C16N4Z	85.445/188.4
HD	132	178	237	205.9	164	50	250	375		

(1) These values are given for a nominal switching frequency of 4 kHz up to **ATV610D45N4Z**, or 2.5 kHz for **ATV610D55N4Z...C16N4Z** for use in continuous operation.
The switching frequency is adjustable from 2...12 kHz up to **ATV610D45N4Z**, or from 1...8 kHz for **ATV610D55N4Z...C16N4Z**. Above 2.5 or 4 kHz (depending on the rating), the drive will automatically reduce the switching frequency in the event of an excessive temperature rise. For continuous operation above the nominal switching frequency, derate the nominal drive current (see the derating curves [Installation Manual](#)).

(2) Typical value for the indicated motor power and for the maximum prospective line Isc.

(3) Values given for applications requiring a slight overload (up to 110% for 60 s or 120% for 20 s).

(4) Values given for applications requiring a slight overload (up to 150% for 60 s).



VW3A9704

PF 140389

Accessories for mounting of variable speed drives

IP conformity kit				
For use with variable speed drives	IP rating	Power		Reference
		kW	HP	
ATV610C11N4...C16N4	IP21	110...160	149...216	VW3A9704
ATV610C11N4Z...C16N4Z	IP20			
ATV610C22N4...C25N4	IP21	220...250	350...400	VW3A9707



Plain text display terminal mounted on the front of an ATV610U07N4 drive

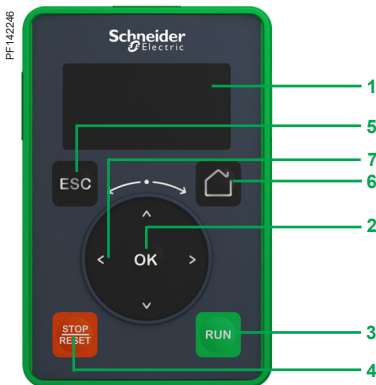

Plain text display terminal

Plain text display terminal

The plain text display terminal is supplied with ATV610●●●N4 drives. It can also be ordered as a spare part.

This terminal can be:

- Connected and mounted on the front of the drive
- Connected and mounted on an enclosure door using a remote-mounting accessory

This terminal is used to:

- Control, adjust, and configure the drive
- Display current values (motor, I/O, and process data)
- Store and download configurations (several configuration files can be stored in the memory)
- Duplicate the configuration of one powered-up drive on another powered-up drive

Other features:

- Displaying the device - via Web server and password; a display terminal is required to log in to the Web server for the first time
- Realtime clock providing data acquisition and event time-stamping functions
- 2 lines
- Languages (Chinese, English, French, German, Italian, Spanish)
- White backlit LCD screen
- Operating range: -15...50 °C/+5...122 °F
- IP21 protection
- Removable, easy plug-in with RJ45 port

Description

The front of the display terminal comprises:

- 1 LCD backlight screen
- 2 OK button: saves the current value (ENT)
- 3 RUN button: local control of motor run command
- 4 STOP/RESET button: local control of motor stop command/clearing detected errors
- 5 ESC button: aborts a value, parameter, or menu to return to the previous selection
- 6 Home: root menu
- 7 Turn ±: navigation dial, increases or decreases the value, goes to the next or previous line

References

Description	Reference	Weight kg/ lb
Plain text display terminal	VW3A1113	0.200/ 0.441

PF142222



Remote mounting kit for mounting plain text display terminal on enclosure door (front panel)

PF142251

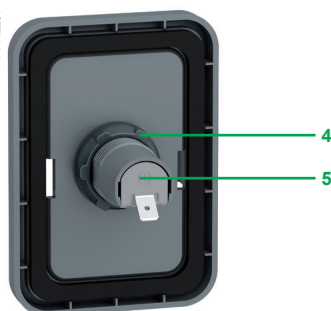

Remote mounting kit for mounting plain text display terminal on enclosure door (rear panel)

Door mounting kit for plain text display terminal

- Remote mounting kit for mounting on an enclosure door with IP43 degree of protection as standard

Description

The kit comprises:

- Tightening tool (also sold separately under the reference ZB5AZ905)
- 1 Mounting plate
- 2 RJ45 port for the plain text display terminal
- 3 Seal
- 4 Fixing nut
- 5 RJ45 port for connecting the remote-mounting cordset

Cordsets should be ordered separately depending on the length required.

Drilling a hole with a standard $\varnothing 22$ mm tool, as used for a pushbutton, allows the unit to be mounted without needing a cut-out in the enclosure ($\varnothing 22.5$ mm/ $\varnothing 0.89$ in. drill hole).

An anti-rotation function is provided that works as follows: when the kit is locked tightly on the panel by the nut, the gasket on the back cannot rotate.

References

Description	Length m/ ft	IP degree of protection	Reference	Weight kg/ lb
Basic keypad door mounting kit Order with remote-mounting cordset VW3A1104R●●●	–	43	VW3A1114	–
Tightening tool for remote mounting kit	–	–	ZB5AZ905	0.016/ 0.035
Remote-mounting cordset equipped with 2 RJ45 connectors	1/ 3.28	–	VW3A1104R10	0.050/ 0.110
	3/ 9.84	–	VW3A1104R30	0.150/ 0.331
	5/ 16.40	–	VW3A1104R50	0.250/ 0.551
	10/ 32.81	–	VW3A1104R100	0.500/ 1.102

PF142250

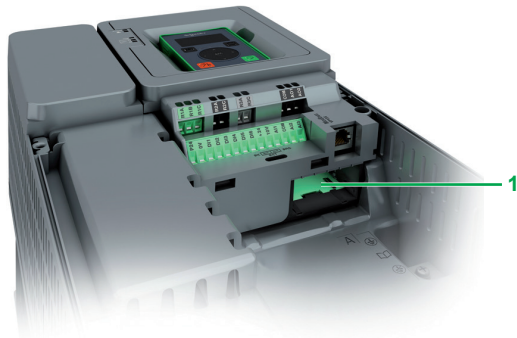

Integrated I/O and I/O option modules

Presentation

Easy Altivar 610 integrates the following types of I/O as standard:

- 3 analog inputs 0...10 V/0...20 mA (software-configurable as voltage, current, temperature probe, and water level sensor)
- 6 digital inputs 24 V DC (2 of which can be programmed as pulse inputs)
- 2 analog outputs 0...10 V/0...20 mA (software-configurable as voltage or current)
- 3 relay outputs (configurable relay logic)

By installing I/O option modules, Easy Altivar 610 drives can meet the needs of applications that manage additional sensors or specific sensors.

Two I/O option modules are available:

- Extended I/O module
- Extended relay module

These I/O modules and the communication modules insert into slot A 1 on Easy Altivar 610 drives.

Extended I/O module

- 2 differential analog inputs configurable via software as current (0-20 mA/4-20 mA) or probe (PTC, PT100, or 2-wire or 3-wire PT1000) inputs
 - 14-bit resolution
- 6 x 24 V $\overline{\text{DC}}$ positive or negative discrete inputs
- Sampling: 1 ms max.
- 2 assignable discrete outputs

Extended relay module

- 3 relay outputs with NO contacts
- 1 fixed screw terminal block

PF140391



Extended I/O module VW3A3203

PF130897



Extended relay module VW3A3204

References

Description	I/O type				Reference	Weight kg/ lb
	Discrete inputs	Discrete outputs	Analog inputs	Relay outputs		
Extended I/O module	6	2	2 (1)	–	VW3A3203	–
Extended relay module	–	–	–	3 (2)	VW3A3204	–

(1) Differential analog inputs configurable via software as current (0-20 mA/4-20 mA) or probe (PTC, PT100, or 2-wire or 3-wire PT1000) inputs.

When configured as PTC probe inputs, they must never be used to protect an ATEX motor in applications in explosive atmospheres. Please refer to the Altivar Process ATV600, ATV900, and Modular ATEX guide.

(2) NO contacts.

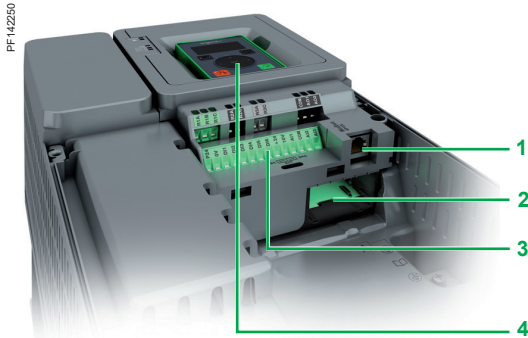

Integrated ports and communication protocol

Presentation

- Easy Altivar 610 drives have two built-in RJ45 communication ports as standard:
- One port dedicated to field network operation for exchanging data with other devices via the Modbus serial link protocol **1**
 - A second dedicated port for the multidrop connection of the following HMIs and configuration tools **4**:
 - the plain text terminal
 - a Harmony industrial HMI terminal

Easy Altivar 610 drives integrate the Modbus serial link communication protocol as standard. The detailed specifications for serial communication ports and the Modbus protocol are available on [our website](#).

Description

- 1** RJ45 serial port
- 2** Slot A for extended I/O or communication modules
- 3** Fixed screw terminal blocks for 24 V \square power supply and integrated I/O
- 4** RJ45 serial link for HMI (remote plain text terminal, Magelis terminal, etc.)

Easy Altivar 610 drives can take one communication module, or digital and analog I/O option module, or relay output module in slot A.

Note: The user manuals and description files (gsd) for devices on the communication buses and networks are available on [our website](#).

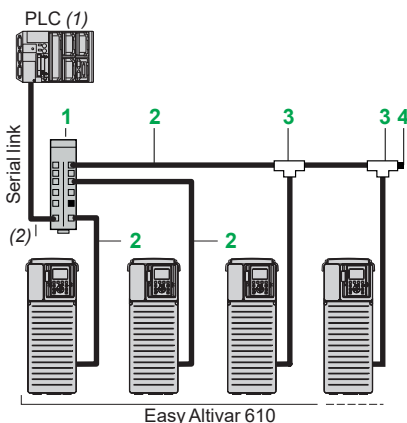

Example of serial link architecture

Integrated serial port connection accessories

Description	Item	Length m/ ft	Unit reference	Weight kg/ lb
Splitter box 10 RJ45 connectors and 1 screw terminal block	1	–	LU9GC3	0.500/ 1.102
Modbus T-junction boxes With 0.3 m/0.98 ft integrated cable	3	0.3/ 0.98	VW3A8306TF03	0.190/ 0.419
With 1 m/3.28 ft integrated cable	3	1/ 3.28	VW3A8306TF10	0.210/ 0.463
Modbus line terminator (3) For RJ45 connector	4	R = 120 Ω C = 1 nf	VW3A8306RC	0.010/ 0.022
Cordsets equipped with 2 RJ45 connectors	2	0.3/ 0.98	VW3A8306R03	0.025/ 0.055
		1/ 3.28	VW3A8306R10	0.060/ 0.132
		3/ 9.84	VW3A8306R30	0.130/ 0.287

(1) Please refer to [our website](#).

(2) Cable dependent on the type of controller or PLC; please refer to the corresponding catalog on [our website](#).

(3) Order in lots of 2.



PROFIBUS DP communication module VW3A3607

PROFIBUS DP communication module

Presentation and functions

Easy Altivar 610 drives can also be connected to other industrial communication buses and networks using the communication module available as an option. This communication module is supplied in "cassette" format for ease of mounting/removal.

Dedicated communication module: PROFIBUS DP.

The PROFIBUS DP V1 module also supports the Profidrive and CiA402 profiles.

It is possible to maintain communication using a separate power supply for the control and power sections. Monitoring and diagnostics are possible via the network even if there is no power supply to the power section.

All drive functions can be accessed via the various communication networks:

- Configuration
- Adjustment
- Control
- Monitoring

Easy Altivar 610 drives offer a high degree of interfacing flexibility with the possibility of assigning, by configuration, the different control sources (I/O, communication networks, and HMI terminal) to control functions in order to meet the requirements of complex applications.

Communication is monitored according to the specific criteria for each protocol.

However, regardless of the protocol, it is possible to configure how the drive responds to a detected communication interruption as follows:

- Define the type of stop when a communication interruption is detected
- Maintain the last command received
- Ignore the detected communication interruption

References

Description	Reference	Weight kg/ lb
PROFIBUS DP communication module Port: 1x 9-way female SUB-D connector Conforming to PROFIBUS DP V1 Profiles supported: <ul style="list-style-type: none"> ■ CiA 402 drive ■ Profidrive Offers several message handling modes based on DP V1	VW3A3607	0.140/ 0.309
IP20 straight connectors (1) for Profibus module (SUB-D connection)	LU9AD7	–

(1) Only straight connectors are compatible with Easy Altivar 610 drives.

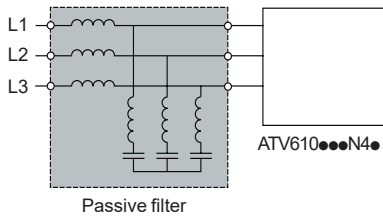

Easy Altivar 610 drive with passive filter

Presentation

Passive filters are used to obtain total harmonic distortion of less than 10%. Reactive power increases at no load or low load. To help reduce this reactive power, the filter capacitors can be disconnected (see the diagrams on [our website](#)). Passive filters provide IP20 protection.

Applications

Reduction of current harmonics in order to use drives in the first environment (restricted distribution, domestic applications).

Passive filters: 400 V 50 Hz three-phase supply

Motor rating		Corresponding Easy Altivar 610 drives	Filter Nominal input current A	Quantity required per drive	Reference	Weight kg/ lb
kW	HP					
THDi < 10%						
0.75	1	ATV610U07N4●	1.7	1	VW3A46098A	7.000/ 15.432
1.5	2	ATV610U15N4●	3.4	1	VW3A46099A	10.000/ 22.046
2.2	3	ATV610U22N4●	6.2	1	VW3A46100A	14.000/ 30.865
3	–	ATV610U30N4●				
4	5	ATV610U40N4●	10	1	VW3A46101A	10.000/ 22.046
5.5	7.5	ATV610U55N4●	13	1	VW3A46102A	10.000/ 22.046
7.5	10	ATV610U75N4●	16	1	VW3A46103A	15.000/ 33.069
11	15	ATV610D11N4●	24	1	VW3A46104A	20.000/ 44.092
15	20	ATV610D15N4●	32	1	VW3A46105A	22.000/ 48.502
18.5	25	ATV610D18N4●	38	1	VW3A46106A	25.000/ 55.116
22	30	ATV610D22N4●	45	1	VW3A46107A	29.000/ 63.934
30	40	ATV610D30N4●	60	1	VW3A46108A	37.000/ 81.571
37	50	ATV610D37N4●	75	1	VW3A46109A	43.000/ 94.799
45	60	ATV610D45N4●	90	1	VW3A46110A	47.000/ 103.617
55	75	ATV610D55N4●	110	1	VW3A46111A	50.000/ 110.231
75	100	ATV610D75N4●	150	1	VW3A46112A	86.000/ 189.597
90	125	ATV610D90N4●	180	1	VW3A46113A	92.000/ 202.825
110	149	ATV610C11N4●	210	1	VW3A46114A	100/ 220
132	178	ATV610C13N4●	260	1	VW3A46115A	125/ 276
160	216	ATV610C16N4●	320	1	VW3A46116A	135/ 298
220	350	ATV610C22N4	380	1	VW3A46118A	157/ 346
250	400	ATV610C25N4	433			



Passive filter VW3A46106A

Presentation

Easy Altivar 610 drives maximum motor cable lengths without dv/dt filters

Easy Altivar 610 drive	Maximum cable length	
	Shielded cables	Unshielded cables
ATV610U07N4●...U55N4●	100 m/328 ft	150 m/492 ft
ATV610U75N4●...D45N4●	100 m/328 ft	200 m/656 ft
ATV610D55N4●...C16N4●	150 m/492 ft	200 m/656 ft
ATV610C22N4, ATV610C25N4		

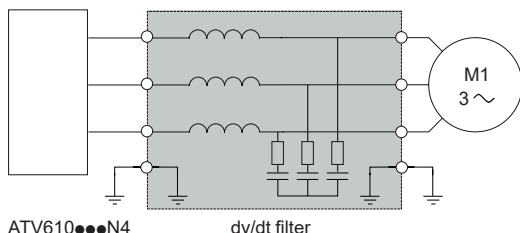

ATV610●●●N4

dv/dt filter

Easy Altivar 610 drive with dv/dt filter

To limit the impact of dv/dt filters and overvoltages at the motor side, it is recommended, for cables longer than 50 m/164 ft, that you check the motor insulation type and add an output filter if necessary.

Output filters are used to limit dv/dt at the motor terminals.

They are also used to:

- Limit overvoltages at the motor terminals to:
 - 1,000 V at 400 V ~ (rms value)
- Filter interference caused by opening a contactor placed between the filter and the motor
- Reduce the motor ground leakage current

The performance of dv/dt filters will be affected if the maximum cable lengths are exceeded. For an application with several motors connected in parallel, the cable length must include all cabling. If a cable longer than that recommended is used, the dv/dt filters may overheat.

dv/dt filters

Corresponding drives	Maximum length of motor cable			Degree of protection	Nominal current	Unit reference	Weight
	Maximum switching frequency (1)	Shielded cable (2)	Unshielded cable (2)				
	kHz	m/ft	m/ft	IP	A		kg/lb
Three-phase supply voltage: 380...460 V							
ATV610U07N4●...U22N4●	4	150/492	200/656	20	6	VW3A5301	11.000/ 24.251
ATV610U30N4●...U55N4●	4	150/492	200/656	20	15	VW3A5302	12.000/ 26.455
ATV610U75N4●...D15N4●	4	250/820	300/984	20	25	VW3A5303	12.000/ 26.455
ATV610D18N4●...D22N4●	4	250/820	300/984	20	50	VW3A5304	18.000/ 39.683
ATV610D30N4●...D45N4●	4	250/820	300/984	20	95	VW3A5305	19.000/ 41.888
ATV610D55N4●...D90N4●	2.5	300/984	350/1,148	00	180	VW3A5306	22.000/ 48.502
ATV610C11N4●...C16N4●	2.5	300/984	350/1,148	00	305	VW3A5307	40.000/ 88.185
ATV610C22N4	2.5	250/820	350/1,148	00	427	VW3A5106	58.000/ 127.868
ATV610C25N4	2.5	200/656	350/1,148	00	481	VW3A5107	93.000/ 205.23

(1) The filters are designed to operate in a switching frequency range of between 2 and 8 kHz.

(2) Values given depend on the nominal switching frequency of the drive. This frequency depends on the drive rating. These cable lengths are given as examples only as they can vary depending on the application. They correspond to motors conforming to IEC 6034-25 and NEMA MG1/31.2006.



EVC250N3125

+



LC1E120

+



ATV610D55N4

Applications

Circuit breaker/contactors/drive combinations help to ensure continuity of service in an installation. The type of circuit breaker/contactors coordination selected can help reduce maintenance costs in the event of a motor short-circuit on the drive input by minimizing the time required to make the necessary repairs and the cost of replacement equipment. The suggested combinations provide coordination according to the drive rating.

The drive controls the motor, provides a monitoring function against short-circuits between the drive and the motor, and helps protect the motor cable against overloads. Overload monitoring is provided by the drive's motor thermal monitoring function if this has been enabled. Otherwise, an external monitoring device such as a probe or thermal overload relay should be provided. The circuit breaker helps protect the drive's power cables against short-circuits.

IEC standard motor starters

Motor Power (1)	Drive reference	Circuit breaker			Line contactor reference (3) (4)
		Global reference	Magnetic protection rating	Icu (1) Ics (2)	
kW HP			A	kA	
Three-phase supply voltage: 380...460 V 50/60 Hz					
0.75 1	ATV610U07N4	GZ1LE08	4	>100 -	LC1E09
1.5 2	ATV610U15N4	GZ1LE10	6,3	>100 -	
2.2 3	ATV610U22N4	GZ1LE14	10	>100 -	
3 -	ATV610U30N4	GZ1LE14	10	>100 -	
4 5.4	ATV610U40N4	GZ1LE14	10	>100 -	
5.5 7.4	ATV610U55N4	GZ1LE16	14	10 50%	LC1E12
7.5 10.1	ATV610U75N4	GZ1LE20	18	10 50%	LC1E18
11 14.9	ATV610D11N4	GZ1LE22	25	10 40%	LC1E25
15 20.3	ATV610D15N4	GZ1LE32	32	10 40%	LC1E32
18.5 25	ATV610D18N4	LV510303	40	25 100%	LC1E40
22 30	ATV610D22N4	LV510304	50	25 100%	LC1E50
30 40	ATV610D30N4	LV510305	63	25 100%	LC1E65
37 50	ATV610D37N4	LV510306	80	25 100%	LC1E80
45 60	ATV610D45N4	EZC100H3100	100	30 25%	LC1E120
55 75	ATV610D55N4	EVC250N3125	125	25 50%	
75 100	ATV610D75N4	EVC250N3150	150	25 50%	LC1E160
90 125	ATV610D90N4	EVC250H2200	200	36 50%	LC1E200
110 149	ATV610C11N4	EVC250H3225	225	36 50%	LC1E250
132 178	ATV610C13N4	EVC250H3250	250	36 50%	
160 216	ATV610C16N4	EVC400H3320N	320	50 100%	LC1E300
220 350	ATV610C22N4	EVC630H3500N	500	50 100%	LC1E400
250 400	ATV610C25N4	EVC630H3500N	500	50 100%	LC1E500

(1) At 400/415 V.

(2) Percentage of Icu, please check the actual power grid capacity before selecting the circuit breaker.

(3) Composition of contactors:

LC1E09...E38: 3 poles + 1 NO auxiliary contact (replace ●● with 10) or 1 NC auxiliary contact (replace ●● with 01)

LC1E40...E160: 3 poles + 1 NO auxiliary contact and 1 NC auxiliary contact

LC1E200...LC1E500: 3 poles

To add auxiliary contacts or other accessories, please refer to the EasyPact TVS catalog.

(4) Replace ●● with the control circuit voltage reference indicated in the table below:

	Volts ~	380	415	440
LC1E06...LC1E500	50 Hz	Q5	N5	R5
LC1E06...LCE95	50/60 Hz	Q7	-	-

For other voltages available between 24 V and 660 V, or a DC control circuit, please contact our [Customer Care Center](#).

Coordination table between drives and fuses						
Variable speed drives				Semi-conductor fuses		
Line current		Isc	Reference	Power	Nominal current	Type
380 V	460 V					
		kA		kW	A	
3.1	2.6	5	ATV610U07N4●	0.75	8	gR
5.7	4.8	5	ATV610U15N4●	1.5	10	gR
7.8	6.5	5	ATV610U22N4●	2.2	12	gR
10.1	8.4	5	ATV610U30N4●	3	20	gR
8.8	7.9	5	ATV610U40N4●	4	16	gR
11.6	10.5	22	ATV610U55N4●	5.5	20	gR
14.7	12.8	22	ATV610U75N4●	7.5	25	gR
22	19.6	22	ATV610D11N4●	11	40	gR
29.4	26.0	22	ATV610D15N4●	15	50	gR
37.2	33.5	22	ATV610D18N4●	18.5	63	gR
41.9	36.2	22	ATV610D22N4●	22	80	gR
62.5	55.8	22	ATV610D30N4●	30	100	gR
76.6	68.3	22	ATV610D37N4●	37	125	gR
92.9	82.7	22	ATV610D45N4●	45	160	gR
111.5	99.7	22	ATV610D55N4●	55	160	gR
147.9	130.2	22	ATV610D75N4●	75	250	gR
177.8	159.9	50	ATV610D90N4●	90	250	gR
200	175.7	50	ATV610C11N4●	110	315	aR
236	203.8	50	ATV610C13N4●	132	350	aR
283	249.5	50	ATV610C16N4●	160	400	aR
397	341	50	ATV610C22N4	220	630	aR
451	383	50	ATV610C25N4	250	700	aR



Variable speed drives 380...460 V IP20

Overall dimensions

Reference	W x H x D	
	mm	in.
ATV610U07N4	145 x 297 x 203	5.71 x 11.69 x 7.99
ATV610U15N4	145 x 297 x 203	5.71 x 11.69 x 7.99
ATV610U22N4	145 x 297 x 203	5.71 x 11.69 x 7.99
ATV610U30N4	145 x 297 x 203	5.71 x 11.69 x 7.99
ATV610U40N4	145 x 297 x 203	5.71 x 11.69 x 7.99
ATV610U55N4	145 x 297 x 203	5.71 x 11.69 x 7.99
ATV610U75N4	145 x 297 x 203	5.71 x 11.69 x 7.99
ATV610D11N4	171 x 360 x 233	6.73 x 14.17 x 9.17
ATV610D15N4	171 x 360 x 233	6.73 x 14.17 x 9.17
ATV610D18N4	211 x 495 x 232	8.31 x 19.50 x 9.13
ATV610D22N4	211 x 495 x 232	8.31 x 19.50 x 9.13
ATV610D30N4	226 x 613 x 271	8.90 x 24.10 x 10.67
ATV610D37N4	226 x 613 x 271	8.90 x 24.10 x 10.67
ATV610D45N4	226 x 613 x 271	8.90 x 24.10 x 10.67
ATV610D55N4	290 x 762 x 323	11.42 x 30 x 12.72
ATV610D75N4	290 x 762 x 323	11.42 x 30 x 12.72
ATV610D90N4	290 x 762 x 323	11.42 x 30 x 12.72
ATV610C11N4	320 x 853 x 390	12.48 x 33.54 x 15.35
With option VW3A9704	320 x 1159 x 390	12.48 x 45.63 x 15.35
ATV610C13N4	320 x 853 x 390	12.48 x 33.54 x 15.35
With option VW3A9704	320 x 1159 x 390	12.48 x 45.63 x 15.35
ATV610C16N4	320 x 853 x 390	12.48 x 33.54 x 15.35
With option VW3A9704	320 x 1159 x 390	12.48 x 45.63 x 15.35
ATV610C22N4	440 x 1196 x 379	17.32 x 47.09 x 14.92
ATV610C25N4	440 x 1196 x 379	17.32 x 47.09 x 14.92

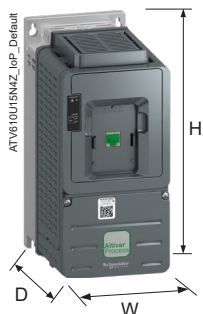

Variable speed drives 380...460 V IP20

Overall dimensions

Reference	W x H x D	
	mm	in.
ATV610U07N4Z	130 x 284 x 196	5.12 x 11.18 x 7.72
ATV610U15N4Z	130 x 284 x 196	5.12 x 11.18 x 7.72
ATV610U22N4Z	130 x 284 x 196	5.12 x 11.18 x 7.72
ATV610U30N4Z	130 x 284 x 196	5.12 x 11.18 x 7.72
ATV610U40N4Z	130 x 284 x 196	5.12 x 11.18 x 7.72
ATV610U55N4Z	130 x 284 x 196	5.12 x 11.18 x 7.72
ATV610U75N4Z	130 x 284 x 196	5.12 x 11.18 x 7.72
ATV610D11N4Z	155 x 345 x 225	6.10 x 13.58 x 8.86
ATV610D15N4Z	155 x 345 x 225	6.10 x 13.58 x 8.86
ATV610D18N4Z	195 x 480 x 225	7.68 x 18.90 x 8.86
ATV610D22N4Z	195 x 480 x 225	7.68 x 18.90 x 8.86
ATV610D30N4Z	212 x 600 x 262	8.35 x 23.62 x 10.31
ATV610D37N4Z	212 x 600 x 262	8.35 x 23.62 x 10.31
ATV610D45N4Z	212 x 600 x 262	8.35 x 23.62 x 10.31
ATV610D55N4Z	268 x 748 x 307	10.55 x 29.45 x 12.09
ATV610D75N4Z	268 x 748 x 307	10.55 x 29.45 x 12.09
ATV610D90N4Z	268 x 748 x 307	10.55 x 29.45 x 12.09
ATV610C11N4Z	300 x 850 x 375	11.81 x 33.46 x 14.76
With option VW3A9704	300 x 1156 x 375	11.81 x 45.51 x 14.76
ATV610C13N4Z	300 x 850 x 375	11.81 x 33.46 x 14.76
With option VW3A9704	300 x 1156 x 375	11.81 x 45.51 x 14.76
ATV610C16N4Z	300 x 850 x 375	11.81 x 33.46 x 14.76
With option VW3A9704	300 x 1156 x 375	11.81 x 45.51 x 14.76

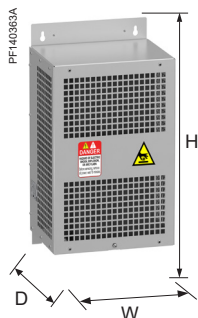

dv/dt filters

Overall dimensions		
Reference	W x H x D	
	mm	in.
VW3A5301	295 x 535 x 215	11.61 x 21.06 x 8.47
VW3A5302	295 x 535 x 215	11.61 x 21.06 x 8.47
VW3A5303	295 x 535 x 215	11.61 x 21.06 x 8.47
VW3A5304	295 x 560 x 245	11.61 x 22.05 x 9.65
VW3A5305	295 x 610 x 245	11.61 x 24.02 x 9.65
VW3A5306	380 x 235 x 350	14.96 x 9.25 x 13.78
VW3A5307	360 x 420 x 270	14.17 x 16.54 x 10.63
VW3A5106	245 x 250 x 200	9.65 x 9.84 x 7.87
VW3A5107	320 x 250 x 220	12.60 x 9.84 x 8.66

Passive filters

Overall dimensions		
Reference	W x H x D	
	mm	in.
VW3A46098A	160 x 360 x 185	6.3 x 14.17 x 7.28
VW3A46099A	160 x 360 x 185	6.3 x 14.17 x 7.28
VW3A46100A	180 x 425 x 206	7.09 x 16.73 x 8.11
VW3A46101A	185 x 390 x 190	7.28 x 15.35 x 7.48
VW3A46102A	185 x 390 x 190	7.28 x 15.35 x 7.48
VW3A46103A	185 x 390 x 190	7.28 x 15.35 x 7.48
VW3A46104A	250 x 455 x 230	9.84 x 17.91 x 9.06
VW3A46105A	250 x 455 x 230	9.84 x 17.91 x 9.06
VW3A46106A	250 x 455 x 230	9.84 x 17.91 x 9.06
VW3A46107A	250 x 455 x 230	9.84 x 17.91 x 9.06
VW3A46108A	280 x 520 x 248	11.02 x 20.47 x 9.76
VW3A46109A	280 x 520 x 248	11.02 x 20.47 x 9.76
VW3A46110A	280 x 520 x 248	11.02 x 20.47 x 9.76
VW3A46111A	280 x 520 x 248	11.02 x 20.47 x 9.76
VW3A46112A	450 x 700 x 385	17.72 x 27.56 x 15.16
VW3A46113A	450 x 700 x 385	17.72 x 27.56 x 15.16
VW3A46114A	450 x 700 x 385	17.72 x 27.56 x 15.16
VW3A46115A	450 x 700 x 385	17.72 x 27.56 x 15.16
VW3A46116A	450 x 700 x 385	17.72 x 27.56 x 15.16
VW3A46118A	650 x 505 x 1,120	25.59 x 19.88 x 44.09

A					
ATV610C11N4	7	ATV610U15N4Z	8	LC1E120R6	17
ATV610C11N4Z	8	ATV610U22N4	6	LC1E1210N5	17
ATV610C13N4	7	ATV610U22N4Z	8	LC1E1210Q5	17
ATV610C13N4Z	8	ATV610U30N4	6	LC1E1210Q6	17
ATV610C16N4	7	ATV610U30N4Z	8	LC1E1210Q7	17
ATV610C16N4Z	8	ATV610U40N4	6	LC1E1210R5	17
ATV610C22N4	7	ATV610U40N4Z	8	LC1E1210R6	17
ATV610C25N4	7	ATV610U55N4	6	LC1E160N5	17
ATV610D11N4	6	ATV610U55N4Z	8	LC1E160Q5	17
ATV610D11N4Z	8	ATV610U75N4	6	LC1E160Q6	17
ATV610D15N4	6	ATV610U75N4Z	8	LC1E160Q7	17
ATV610D15N4Z	8	E		LC1E160R5	17
ATV610D18N4	6	EZC100H3100	17	LC1E160R6	17
ATV610D18N4Z	8	EZC250H2200	17	LC1E1801N5	17
ATV610D22N4	6	EZC250H3225	17	LC1E1801Q5	17
ATV610D22N4Z	8	EZC250H3250	17	LC1E1801Q6	17
ATV610D30N4	6	EZC250N3125	17	LC1E1801Q7	17
ATV610D30N4Z	8	EZC250N3150	17	LC1E1801R5	17
ATV610D37N4	6	EZC400H3320N	17	LC1E1801R6	17
ATV610D37N4Z	8	G		LC1E1810N5	17
ATV610D45N4	7	GZ1LE08	17	LC1E1810Q5	17
ATV610D45N4Z	8	GZ1LE10	17	LC1E1810Q6	17
ATV610D55N4	7	GZ1LE14	17	LC1E1810Q7	17
ATV610D55N4Z	8	GZ1LE16	17	LC1E1810R5	17
ATV610D75N4	7	GZ1LE20	17	LC1E1810R6	17
ATV610D75N4Z	8	GZ1LE22	17	LC1E200N5	17
ATV610D90N4	7	GZ1LE32	17	LC1E200Q5	17
ATV610D90N4Z	8	L		LC1E200Q6	17
ATV610U07N4	6	LC1E0901N5	17	LC1E200Q7	17
ATV610U07N4Z	8	LC1E0901Q5	17	LC1E200R5	17
ATV610U15N4	6	LC1E0901Q6	17	LC1E200R6	17
ATV610U15N4Z	8	LC1E0901Q7	17	LC1E2501N5	17
		LC1E0910R5	17	LC1E2501Q5	17
		LC1E0910R6	17	LC1E2501Q6	17
		LC1E0910N5	17	LC1E2501Q7	17
		LC1E0910Q5	17	LC1E2501R5	17
		LC1E0910Q6	17	LC1E2501R6	17
		LC1E0910Q7	17	LC1E250N5	17
		LC1E0910R5	17	LC1E250Q5	17
		LC1E0910R6	17	LC1E250Q6	17
		LC1E1201N5	17	LC1E250Q7	17
		LC1E1201Q5	17	LC1E250R5	17
		LC1E1201Q6	17	LC1E250R6	17
		LC1E1201Q7	17	LC1E2510N5	17
		LC1E1201R5	17	LC1E2510Q5	17
		LC1E1201R6	17	LC1E2510Q6	17
		LC1E120N5	17	LC1E2510Q7	17
		LC1E120Q5	17	LC1E2510R5	17
		LC1E120Q6	17	LC1E2510R6	17
		LC1E120Q7	17	LC1E300N5	17
		LC1E120R5	17	LC1E300Q5	17
				LC1E300Q6	17
				LC1E300Q7	17
				LC1E300R5	17
				LC1E300R6	17
				LC1E3201N5	17
				LC1E3201Q5	17
				LC1E3201Q6	17
				LC1E3201Q7	17
				LC1E3201R5	17
				LC1E3201R6	17
				LC1E3210N5	17
				LC1E3210Q5	17
				LC1E3210Q6	17
				LC1E3210Q7	17
				LC1E40N5	17
				LC1E40Q5	17
				LC1E40Q6	17
				LC1E40Q7	17
				LC1E40R5	17
				LC1E40R6	17
				LC1E50N5	17
				LC1E50Q5	17
				LC1E50Q6	17
				LC1E50Q7	17
				LC1E50R5	17
				LC1E50R6	17
				LC1E65N5	17
				LC1E65Q5	17
				LC1E65Q6	17
				LC1E65Q7	17
				LC1E65R5	17
				LC1E65R6	17
				LC1E80N5	17
				LC1E80Q5	17
				LC1E80Q6	17
				LC1E80Q7	17
				LC1E80R5	17
				LC1E80R6	17
				LV510303	17
				LV510304	17
				LV510305	17
				LV510306	17
				LU9AD7	14
				LU9GC3	13
				V	
				VW3A1104R10	11
				VW3A1104R100	11
				VW3A1104R30	11
				VW3A1104R50	11
				VW3A1113	10
				VW3A1114	11
				VW3A3203	12
				VW3A3204	12
				VW3A3607	14
				VW3A46098A	15
				VW3A46099A	15
				VW3A46100A	15
				VW3A46101A	15
				VW3A46102A	15
				VW3A46103A	15
				VW3A46104A	15
				VW3A46105A	15
				VW3A46106A	15
				VW3A46107A	15
				VW3A46108A	15
				VW3A46109A	15
				VW3A46110A	15
				VW3A46111A	15
				VW3A46112A	15
				VW3A46113A	15
				VW3A46114A	15
				VW3A46115A	15
				VW3A46116A	15
				VW3A5106	16
				VW3A5107	16
				VW3A5301	16
				VW3A5302	16
				VW3A5303	16
				VW3A5304	16
				VW3A5305	16
				VW3A5306	16
				VW3A5307	16
				VW3A8306R03	13
				VW3A8306R10	13
				VW3A8306R30	13
				VW3A8306RC	13
				VW3A8306TF03	13
				VW3A8306TF10	13
				VW3A9704	9
				VW3A9707	9
				Z	
				ZB5AZ905	11

Legal information

The information provided in this Catalog contains description of Schneider Electric products, solutions and services ("Offer") with technical specifications and technical characteristics of the performance of the corresponding Offer.

The content of this document is subject to revision at any time without notice due to continued progress in methodology, design and manufacturing.

To the extent permitted by applicable law, no responsibility or liability is assumed by Schneider Electric and its subsidiaries for any type of damages arising out of or in connection with (i) informational content of this Catalog not conforming with or exceeding the technical specifications, or (ii) any error contained in this Catalog, or (iii) any use, decision, act or omission made or taken on basis of or in reliance on any information contained or referred to in this Catalog.

SCHNEIDER ELECTRIC MAKES NO WARRANTY OR REPRESENTATION OF ANY KIND, WHETHER EXPRESS OR IMPLIED, AS TO WHETHER THIS CATALOG OR ANY INFORMATION CONTAINED THEREIN SUCH AS PRODUCTS AND SERVICES WILL MEET REQUIREMENTS, EXPECTATIONS OR PURPOSE OF ANY PERSON MAKING USE THEREOF.

Schneider Electric brand and any trademarks of Schneider Electric and its subsidiaries referred to in this Catalog are property of Schneider Electric or its subsidiaries. All other brands are trademarks of their respective owners.

This Catalog and its content are protected under applicable copyright laws and provided for informative use only. No part of this Catalog may be reproduced or transmitted in any form or by any means (electronic, mechanical, photocopying, recording, or otherwise), for any purpose, without the prior written permission of Schneider Electric.

Copyright, intellectual, and all other proprietary rights in the content of this Catalog (including but not limited to software, audio, video, text, and photographs) rests with Schneider Electric or its licensors. All rights in such content not expressly granted herein are reserved. No rights of any kind are licensed or assigned or shall otherwise pass to persons accessing this information.

Life Is On



Learn more about our products at
www.se.com

Design: Schneider Electric
Photos: Schneider Electric

Schneider Electric Industries SAS

Head Office
35, rue Joseph Monier - CS 30323
F-92500 Rueil-Malmaison Cedex
France

DIA2ED2140702EN
March 2024 - V10.0