

Datasheet

ENGLISH

RS PRO, 12 V dc, 12000 gcm, Brushed DC Geared Motor, Output Speed 23 rpm

Stock No: 417-9677



Specifications:

Output Speed	23 rpm
Supply Voltage	12 V dc
Maximum Output Torque	12000 g.cm
DC Motor Type	Brushed
Shaft Diameter	6mm
Power Rating	7.85 W
Gearhead Type	Planetary
Length	80.3mm
Width	32 (Dia.) mm
Current Rating	990 mA
Weight	239g

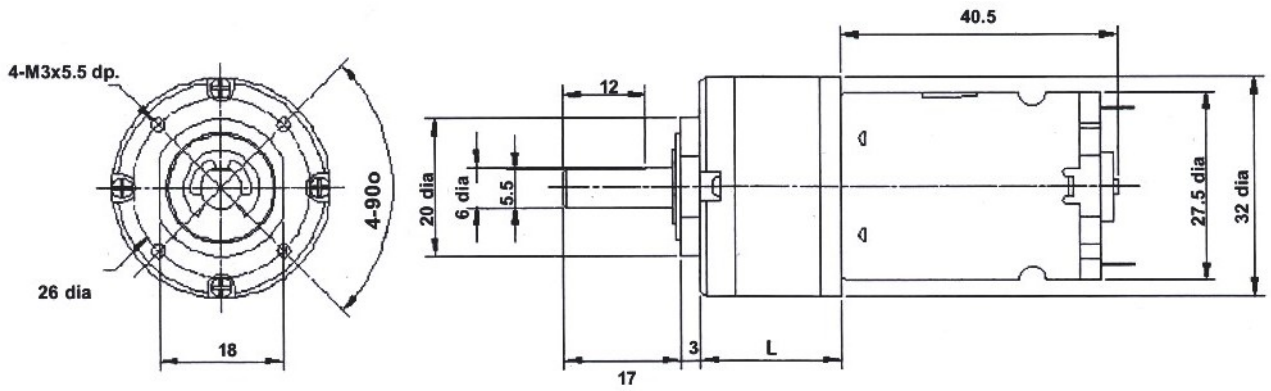

Ratio	L
100:1	39.8mm

Gearbox Housing material	Metal
Backlash at no-load	< 2.5°
Bearing at output	Sleeve bearings
Radial load (10mm from flange)	< 3 kgf
Shaft axial load	< 2.5 kgf
Shaft press fit force max	< 10 kgf
Radial play of shaft	< 0.08mm
Thrust play of shaft	< 0.3mm

Reduction Ratio	Rated tolerance Torque	Max momentary Tolerance Torque	Efficiency
1/516	12.0 kgf-cm Max.	36.0 kgf-cm	50%

Reduction Table RPM SUPPLY VOLTAGE	4.5v	6v	9v	12v	15v
417-9677	8	11	17	23	28

Note: Motor speeds may vary by (+) or (-) 12.5%