

Datasheet

RS 107 Series 2.77mm Pitch 25 Way Right Angle PCB D-sub Connector, Socket, Solder Termination, with 4-40 UNC Screwlocks

RS Stock number 811-7125

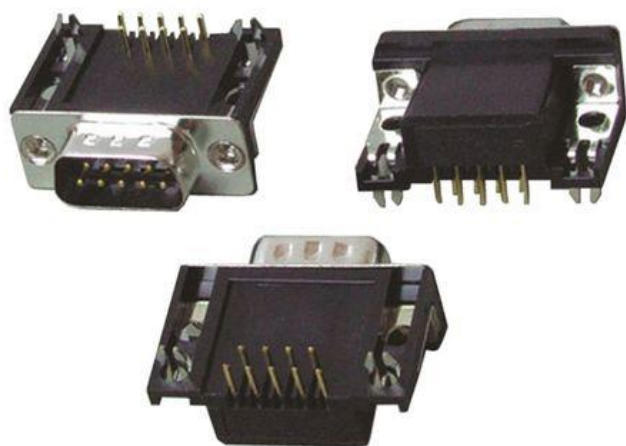

Dimensions: (mm)

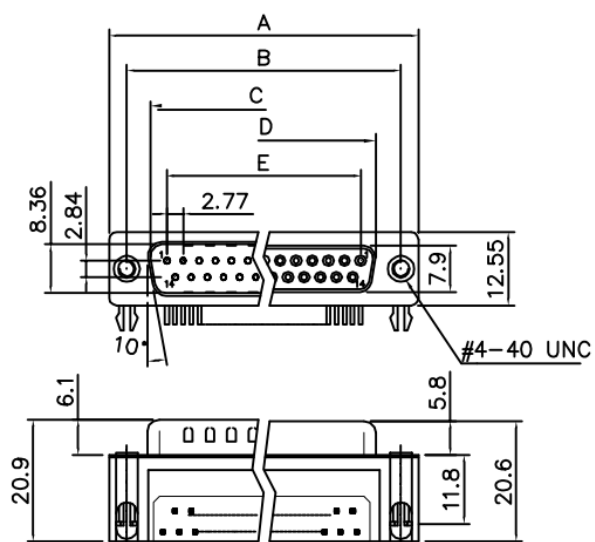

RoHS COMPLIANT

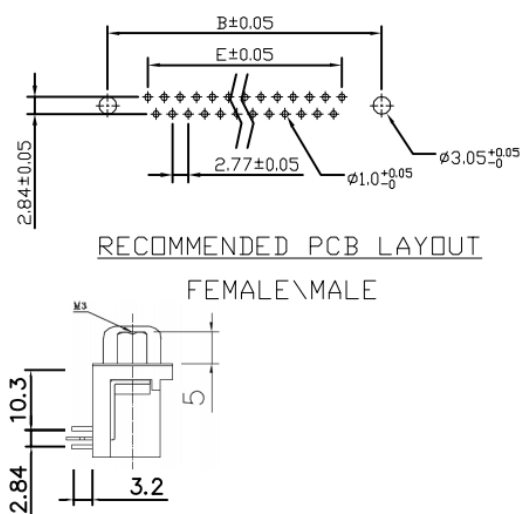



Product Specification

Material

Insulator : Glass-Filled Thermoplastic PBT, UL94V-0

Contact : Brass

Shell : Steel, 100u" Tin Over 50u" min Copper

Clinch Nut : Brass, Nickel Plated.

Boardlock : Brass, Tin Plated.

Screwlock : Brass, Nickel Plated.

Electrical

Contact Resistance : 20 milliohms
Max at 1 AMP DC.

Insulation Resistance : 1000
magohms at 500 VDC

Dielectric Withstanding Voltage :
1000 VAC/rms 60Hz for 1 minute

Current Rating : 3 AMP

Volatge Rating : 250 VAC/rms 60Hz

Dimensions

Positions	A	B	C	D	E
9	30.81	24.99	16.92	16.33	11.08
15	39.20	33.30	25.25	24.70	19.39
25	53.05	47.04	38.96	38.40	33.24
37	69.40	63.50	55.42	54.80	49.86