









Datasheet

Stock Number :	188-1132	188-1133	188-1134	188-1135	188-1136	188-1137	188-1138	188-1139	188-1140
									
Colour:	RED	GREEN	RED	RED	GREEN	BLUE	BLACK	BLACK	GREEN





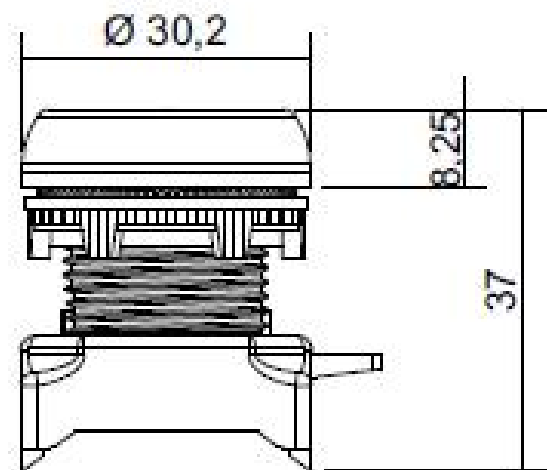



22MM Flush Push Button Head - Printed



Printed flush push button heads for use with the RS pro modular plastic push button series. Robust design in a variety of colours and markings with modern silver coloured bezel. Simple installation via standard lock nut.

Specifications:

- 22mm Diameter
- Sprung return head
- IP65 rated
- Contact block mounting clip included
- Stackable design for contact blocks (max 9)
- Mechanical life more than 1 million uses.

Stock Number:	188-1132	188-1133	188-1134	188-1135	188-1136	188-1137	188-1138	188-1139	188-1140
									
Colour	RED	GREEN	RED	RED	GREEN	BLUE	BLACK	BLACK	GREEN
Marking (White)	0	I	STOP	ARRET	MARCHE	RESET	↑	↓	START
Cut out Diameter	22.5mm								
Actuation	Spring Return								
Style	Flush								
IP Rating	IP65								
Shape	Round								
Mounting Type	Panel Mounted								
Body Material	Plastic								

Accessories:

RS Stock Number	Accessory Type
188-1168	Normally Open Contact Block – Screw Terminal
188-1169	Normally Closed Contact Block – Screw Terminal
188-1170	Normally Open Contact Block – Spring Terminal
188-1171	Normally Closed Contact Block – Spring Terminal
175-3955	Legend Plate CLOSE Pack of 5
175-3956	Legend Plate DOWN Pack of 5
175-3958	Legend Plate FORWARD Pack of 5
175-3960	Legend Plate OFF - ON Pack of 5
175-3961	Legend Plate OPEN Pack of 5
175-3962	Legend Plate RESET Pack of 5

175-3964	Legend Plate REVERSE Pack of 5
175-3965	Legend Plate START Pack of 5
175-3966	Legend Plate STOP Pack of 5
175-3967	Legend Plate UP Pack of 5
182-8655	Pushbutton Enclosure, 1 Hole, Plastic, Grey, 22mm Cut Out
182-8656	Pushbutton Enclosure, 2 Hole, Plastic, Grey, 22mm Cut Outs
182-8657	Pushbutton Enclosure, 3 Hole, Plastic, Grey, 22mm Cut Outs
182-8658	Pushbutton Enclosure, 4 Hole, Plastic, Grey, 22mm Cut Outs