

Plug PowerTOP® - Part no.3813

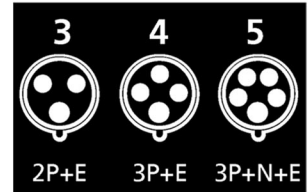

- screw terminals
- highly heat resistant contact carrier
- nickel plated contacts
- cable gland and external cable grip



Protection type	IP 67
Ampere	16A
Poles	4p
Voltage	440V
Hertz	60Hz
Earth position	11h
Contact	nickel plated contacts, highly heat resistant contact carrier
Connection technology	Screw terminals

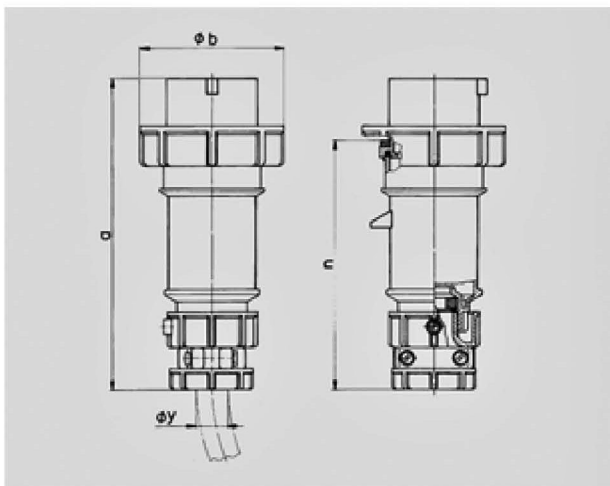

Drawing	Amp.	16			32		
		3	4	5	3	4	5
2 MB 171	Poles						
Dim. in mm	a	162	172	186	199	199	213
	b	71	79	89	95	95	102
	n	129	139	152	157	157	172
	y	19	19	22	24,5	24,5	28,5
Terminal for cond. cross		1	1	1	2,5	2,5	2,5
section (mm ²) min.-max.		-2,5	-2,5	-2,5	-6	-6	-6

