



Pact Series

# ComPact NSX & NSXm

## Catalog 2019

Molded-case circuit breakers  
and switch-disconnectors  
from 16 to 630 A - up to 690 V



• WEB1 cat.2019

[se.com](http://se.com)

Life Is On

**Schneider**  
Electric





# Innovation that protects

## 60 years of innovative and reliable protection

The Schneider Electric™ Com**Pact** range is built on 60 years of expertise and leadership in industrial circuit breakers.

Schneider Electric is continuously introducing new features and innovations in its range of molded case circuit breakers.

The comprehensive, optimized Com**Pact** NSX range covers your protection needs and now comes in a smaller size, and with integrated earth leakage protection.

The range combines intelligent metering and monitoring, along with advanced protective functions.

This range can be connected to Schneider Electric's open, interoperable, IoT- (Internet of Things) enabled EcoStruxure™ Power architecture. Through this platform we deliver enhanced value in terms of safety, reliability, efficiency, sustainability, and connectivity for our customers.

We leverage technologies in IoT, mobility, sensing, cloud, analytics, and cybersecurity to deliver Innovation at Every Level.

This includes connected products, edge control, apps, analytics and services.



1952

Com**Pact** NW



Com**Pact** C

1974

Com**Pact** C



Com**Pact** NS

1994

Com**Pact** NS



Com**Pact** NSX

2008

Com**Pact** NSX



Com**Pact** NSXm

2017

Com**Pact** NSXm



Com**Pact** NSX & NSXm with MicroLogic Vigi

2018

Com**Pact** NSX & NSXm with MicroLogic Vigi

# ComPact NSX and NSXm, even more innovative and efficient

ComPact circuit breakers feature Schneider Electric's exclusive Roto-Active Breaking System; it reduces the effects of short circuits of your installation.

Today, the ComPact range is optimized with a high level of breaking capacities, outstanding selectivity and cascading. It offers more advanced functions and ergonomic designs for easy installation and operations.

## Ten performance levels

HB2 | HB1 | R | L | S | H | N | F | B | E

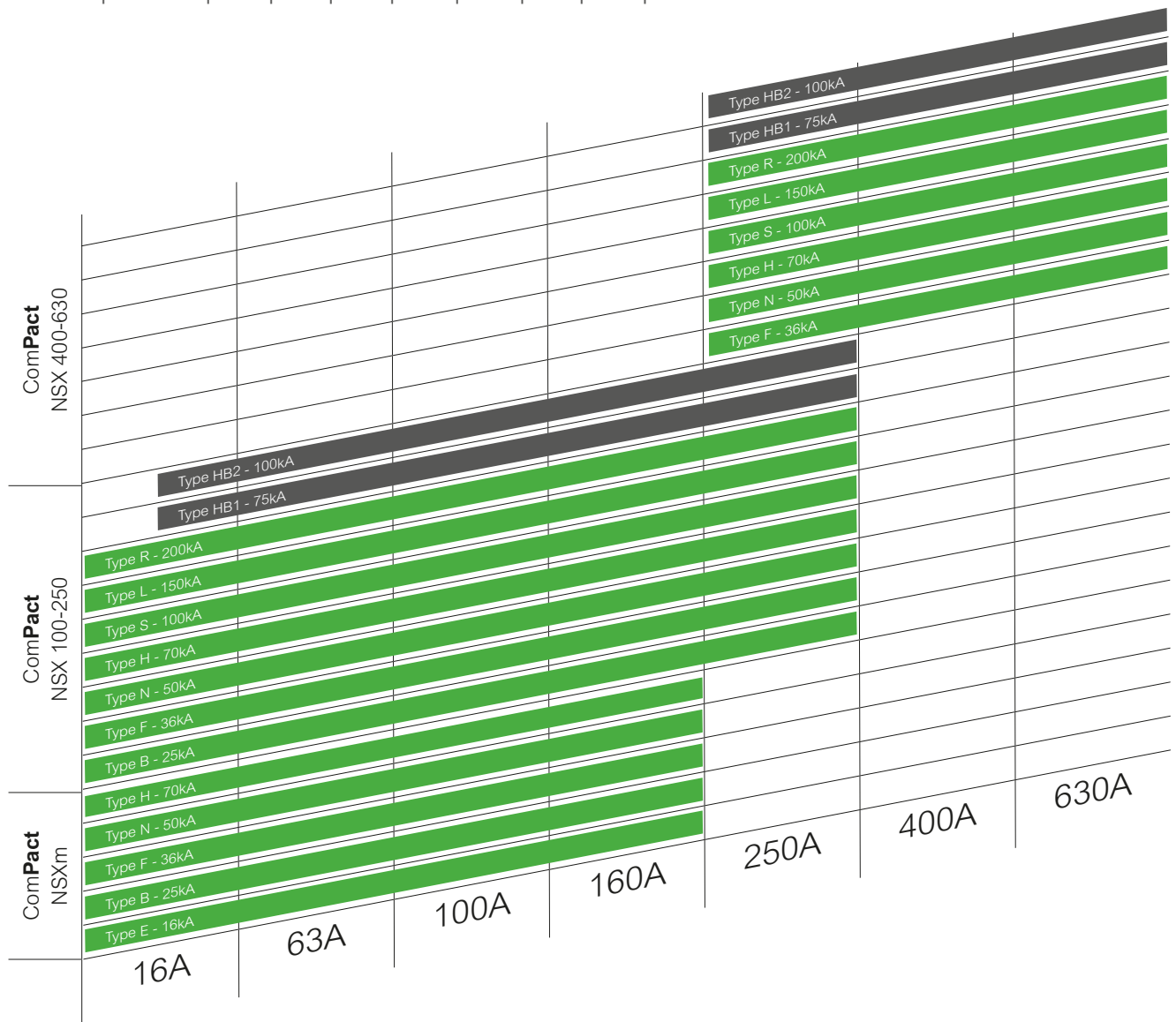

Icu = (kA rms) at 690V AC  
 Icu = (kA rms) at 415V AC

Schneider Electric is proud to introduce two new innovations to the Com**Pact** NSX range. As the latest family member, Com**Pact** NSXm comes to you with a smaller footprint as well as integrated earth leakage protection - which is available across the range.

New

## Com**Pact** NSXm



### Smallest size in the range

- The **smallest frame size** in the Com**Pact** NSX range, incorporating new features and innovations
- **Gain up to 40%** in space when using with integrated earth leakage protection
- **Reduce up to 40%** mounting and cabling time with EverLink™ connectors, built-in DIN rail and spring-type auxiliaries
- **Select, configure and commission** with ease, thanks to Schneider Electric online tools: EcoStruxure Customer Lifecycle Software

New

## MicroLogic Vigi



### Integrated earth leakage protection

- **Easy to integrate** into a row that does not have earth leakage protection
- **Simple to use**, reliable, and now comes in the same frame size, and for the same panel support
- **Gain up to 40%** in space when using with integrated earth leakage protection into the MicroLogic Vigi trip units
- **Part of the EcoStruxure Power architecture**, with digital communication capability and data management (settings, measurement, pre-alarms, trip & test history)

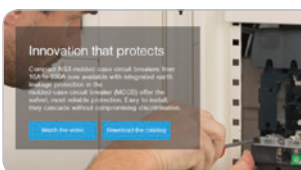

Innovation that protects:  
Learn about the benefits of the Com**Pact** NSX range here:  
[se.com/compact-nsx](https://se.com/compact-nsx)



Scan or click on QR code





# Reliability that fits

## Made to protect

You can depend on the Com**Pact** range, even in the most stressful of environments. The Com**Pact** range addresses demanding applications, thanks to its high level of breaking capacities.

- An excellent choice for standard and specific applications
- The highest-rated breaking capacity in its class with 100kA at 690V
- Quality-certified by independent authorities
- Extended breaking capacity available in the same space-saving Com**Pact** NSX frame size



Compliance with international standards and for specific applications. See catalog for details.



# Optimized size and innovations tailored to your needs.

## Roto-active™ breaking technology

While the Com**Pact** NSXm is the smallest breaker in the Com**Pact** range, it nonetheless features all the innovations from previous generations, and notably includes roto-active breaking technology.

Schneider Electric was the first to introduce this technology - an innovation in which the effective fault current limitation benefits the entire installation, particularly its cables.

Reduce the effects of short circuits to extend your installation life:

- Increase life duration of all items downstream of the electrical network
- Provide both outstanding selectivity and cascading



Learn about Roto-active breaking technology:



Scan or click on QR code



## EverLink™ connectors - for enduring safety



New

### Com**Pact** NSXm

The Com**Pact** NSXm features EverLink, an innovative cable connection method with patented creep-compensating technology that is built directly into the terminal. EverLink gives you:

- Confidence that your electrical connections maintain consistent pressure on the cable over time
- A space-saving solution as bare cable connections are as reliable as compression lug cable connections
- IP40 protection available thanks to transparent long terminal shield

Learn about EverLink online:



Scan or click on QR code

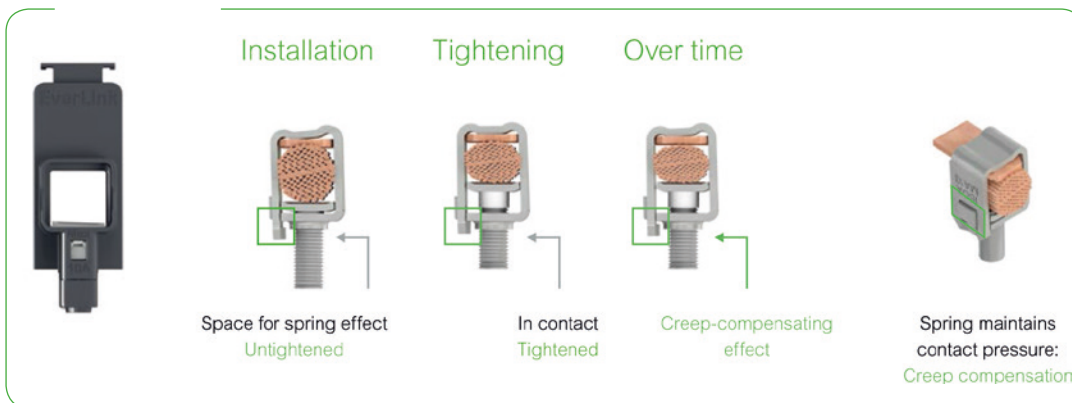



# Efficiency that clicks

## Mounting, installing and cabling made easier

Today, the Com**Pact** range is optimized with a high level of breaking capacity, outstanding selectivity and cascading.

It offers more advanced functions and ergonomic designs for easy installation and operations.

The latest innovations that reinforce this:

- The Com**Pact** NSXm is an innovative frame that minimizes space occupation with combinations up to 160A
- Com**Pact** NSX and NSXm are now available with integrated earth leakage protection via MicroLogic Vigi trip unit technology.



## Software for each step of your project

To complement its high-quality products, Schneider Electric offers power supply professionals a wide range of online and offline software tools that help to improve efficiency at all stages of your project. These resources include: EcoStruxure Power Design, EcoStruxure Power Build, EcoStruxure Power Commission and Product Selector.

Free download here:

[se.com](https://www.se.com)

Life Is On

**Schneider**  
Electric





## ComPact NSXm

### Smallest size in the range

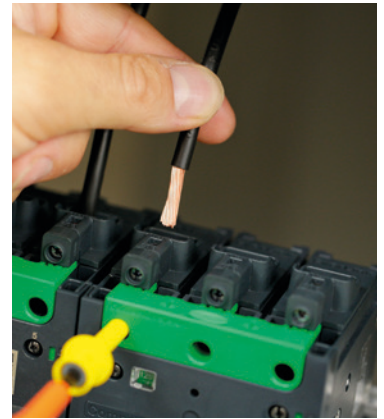

#### Flexible installation for your convenience

Click your ComPact NSXm into place with the built-in DIN rail - no extra parts required. Alternatively, vertical plate mounting means you can save space. Available with integrated MicroLogic Vigi.

#### Power connections made more efficient

EverLink connectors for reliable and quick bare cable connections. Innovative torque-limiting breakaway bits can be used to tighten power connections in the field.



Scan or click on QR code



Scan or click on QR code



## MicroLogic Vigi

### Integrated earth leakage protection



#### Free up space in your panel board

The ComPact NSX with integrated earth leakage protection fits perfectly in a row with circuit breakers which do not have earth leakage protection. ComPact NSXm is also available with MicroLogic Vigi.

#### Save time and effort

Now there's no need to order separate earth leakage modules. Save time, now that there's one less item to add to the panel board.



# Innovation that protects

## Maintenance made more efficient

The Com**Pact** range combines intelligent metering and monitoring with advanced protective functions. The range can be connected as part of an EcoStruxure Power digital architecture. By measuring performance data and offering performance analysis, building owners and managers can anticipate and prevent issues throughout lifecycle of the equipment.



### Instant access to product information

Scan the Com**Pact** NSXm QR code for product information and easy access to the customer care center.

### Visible auxiliaries

One-click auxiliaries on the Com**Pact** NSXm with field-installable accessories and auxiliaries. Their presence in the breaker is externally visible through flags and its window.



Visible auxiliaries



Scan or click on QR code



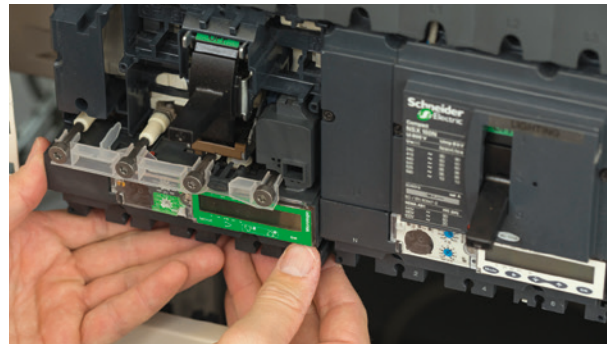

### Real-time connectivity

Thanks to the advanced MicroLogic Vigi trip unit, EcoStruxure Power notifies in the event of overloads or current leakage, before tripping thresholds are reached.

### Easy product upgrades

Simply upgrade the Com**Pact** NSX to improve circuit breaker functionality – and to take advantage of earth leakage protection and digital communication. Just replace the former MicroLogic or Thermal-Magnetic trip unit with the new MicroLogic Vigi.

## Connectivity: from corrective to predictive maintenance

As Schneider Electric’s IoT-connected power supply architecture, EcoStruxure Power makes maintenance more effective, and reduces the probability and duration of blackouts. Com**Pact** circuit breakers play a major role in the EcoStruxure architecture, acting as watchdogs over the power supply systems, and providing data to digital architectures and monitoring software.

### Corrective maintenance

EcoStruxure Power enables maintenance managers to dramatically reduce power outage duration.

Example: In case of a tripped breaker, the system automatically sends email alerts. Technical staff can diagnose the incident remotely, decide upon the appropriate actions, and monitor the results.

### Preventative maintenance

Enables technicians to fix issues before impacting the comfort and productivity of building occupants. This is done by:

- Sending remote warnings as soon as a creeping fault is detected, especially current leakage.
- Assisting during routine checks, making sure all points are verified regularly and providing access to all information, including event logs, in case of a suspected weakness.

The available information enables preventive maintenance based on wear-out indications and warnings sent via the digital system.

### Predictive maintenance

Data collected across the power distribution network, stored and computed by Schneider Electric analytics, provides greater insight for improved long-term planning and life-cycle management. Furthermore, advanced data processing enables predictive maintenance.

Example: By analyzing historical data and monitoring load profiles, maintenance and upgrades can be scheduled efficiently.



Learn about connectivity online:



Scan or click on QR code

EcoStruxure Power connected products – 2018 catalog

# Embrace an open partner ecosystem

Today's value chain in electrical distribution is highly fragmented and inefficient from design to maintenance.

With EcoStruxure Power solutions, Schneider Electric can strengthen and simplify the entire project path by shaping a unique ecosystem of specifiers, contractors, panel builders, integrators, distributors and facility managers serving end users.

For these electrical distribution professionals, EcoStruxure Power provides opportunities to broaden and improve the services they offer their customers.

- A comprehensive and innovative range of IoT-enabled LV and MV offers
- Proven, interoperable reference architectures for any building or business
- Design, selection, commissioning and configuration tools to enhance deployment efficiencies across the project life cycle.

## 450,000+

EcoStruxure installations

## 1 billion

connected devices.

### Apps, Analytics & Services



Actionable predictive maintenance information that protects your customers, safeguard your reputation and minimizing financial impact.

### Edge Control



Track maintenance activity to reduce downtime, energy use, and maintenance costs while improving site planning and revealing additional capacity.

### Connected Products

Pinpoint overloads and inefficiencies proactively, make informed decisions that improve operational efficiency, and finally stop chasing vague alarms



ComPact NSX & NSXm MCCBs



PowerTag wireless energy sensor



MasterPact MTZ air circuit breaker



Smart Panels



Galaxy UPS



Altivar



PowerLogic power quality meters



SM6 MV switchgear

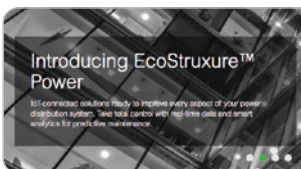

EcoStruxure Power:  
Visit our webpage to discover your possibilities  
[se.com/ecostruxure-power](http://se.com/ecostruxure-power)



Scan or click on QR code



# Contribute to a better world. Enhance sustainability with Com**Pact** NSX & NSXm

## Achieve Green Building certification with Green Premium ecolabel

In compliance with ISO 14025 PEP ecopassport program, we publish a comprehensive Life Cycle Analysis of our product, providing the environmental data you need to achieve Green Building certifications.

For example, Com**Pact** NSX & NSXm contributes to 3 LEED™ points in the Building Product Disclosure and Optimization section:

- Environmental Product Declaration
- Material Ingredients



Com**Pact** NSX range is now enriched with the new Com**Pact** NSXm, designed according to the EcoDesign Way™ by Schneider. It now features new space saving frame size for reduced resource consumption, and more.

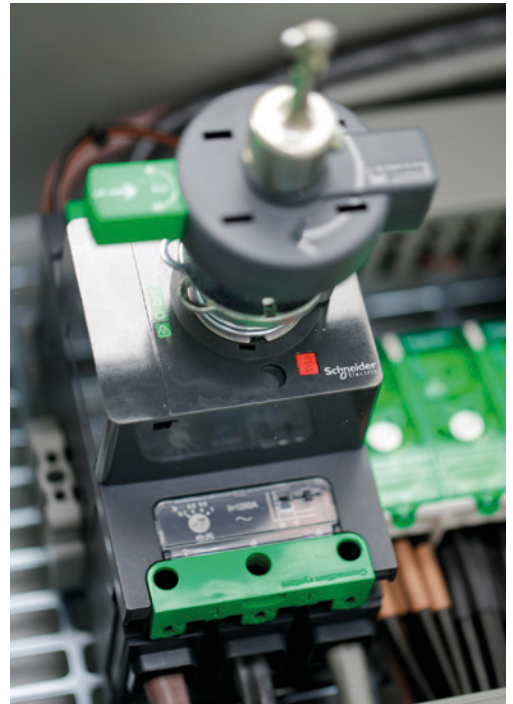

### Space saving

The new 160A frame has been designed with a volume 40% smaller, using less resources to manufacture and saving a significant amount of space

### Halogen free

The Com**Pact** NSXm TMD is free of halogenated flame retardants in plastic

This product is REACH and RoHS compliant



## Same technology, same offer, simpler names

We're making it easier for you to navigate across the wide range of our world-class digital offerings and select with confidence the offers that are right for you and your needs.

### EcoStruxure Architecture

To enable brand consistency, relevance and impact, we are reinforcing our EcoStruxure™ architecture and digital customer lifecycle tools to ensure a seamless experience from the CAPEX to OPEX phases of each project, bridging our entire ecosystem of partners, services providers and end users.

EcoStruxure is our IoT-enabled open and interoperable system architecture and platform. EcoStruxure delivers enhanced values around safety, reliability, efficiency, sustainability and connectivity for our customers. EcoStruxure leverages advancements in IoT, mobility, sensing, cloud, analytics, and cybersecurity technologies to deliver Innovation At Every Level from Connected Products; Edge Control; and Apps, Analytics & Services: our IoT technology Levels.

Old names	New names
Ecodial	EcoStruxure Power Design
Ecoreal	EcoStruxure Power Build
Ecoreach	EcoStruxure Power Commission
Masterpact MTZ mobile App	EcoStruxure Power Device App

### Pact Series

Future-proof your installation with Schneider Electric's low and medium voltage **Pact** Series. Built on legendary Schneider Electric innovation, the **Pact** Series comprises world-class circuit breakers, switches, residual current devices and fuses, for all standard and specific applications. Experience robust performance with this comprehensive range of EcoStruxure-ready switchgear, for all applications from 16 to 6300A.

Old names	New names
Compact	Com <b>Pact</b>
Masterpact	Master <b>Pact</b>
Micrologic	Micro <b>Logic</b>
Transferpact	Transfer <b>Pact</b>
Fupact	Fu <b>Pact</b>

# General contents

## ComPact NSXm & NSX

Presentation

Select your circuit breakers and switch-disconnectors

Select your protection

Customize your circuit breaker with accessories

Smart Panel integration

Switchboard integration

Catalog numbers

Glossary

Additional characteristics

A

B

C

D

E

F

G

H

# ComPact NSXm & NSX

## Overview of applications

The ComPact NSX and NSXm circuit breakers and switch-disconnectors are the best choice for all standards and specific applications.

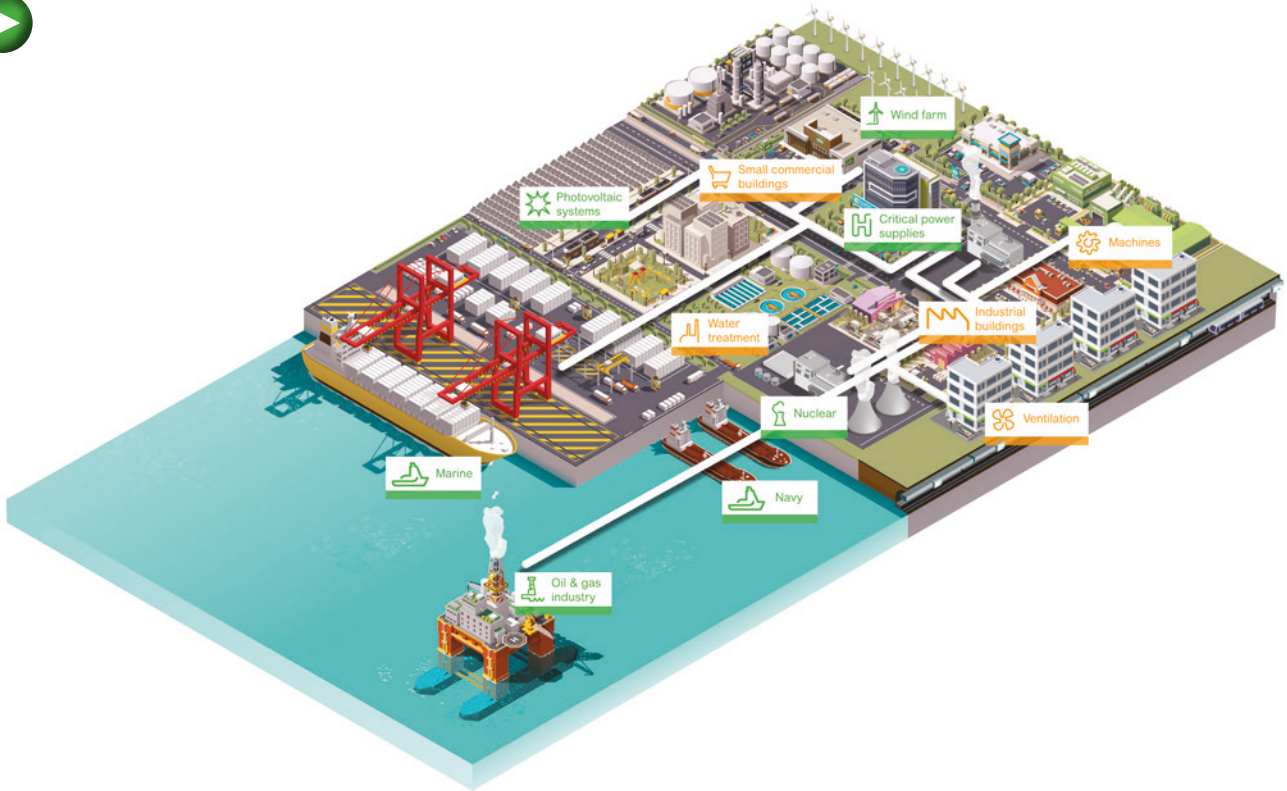

> ComPact INS/INV [a]



LVPED213024EN

> FuPact [a]



LVPED216031EN

> Substitution and technical guide ComPact NSX high performances [b]



LVPED508025EN

> ComPact NSX, ComPact INS/INV, MasterPact NW DC - DC PV [c]



LVPED208006EN

> TransferPact (source-changeover systems [d])



LVPED216028EN

> Complementary technical information



LVPED318033EN



# ComPact NSXm & NSX

## Overview of applications

### Buildings

ComPact NSXm devices up to 160 A (70 kA/415 V) are equipped with thermal magnetic trip units.

ComPact NSX devices up to 630A (200kA/415V) are equipped with Magnetic, Thermal Magnetic, basic electronic trip units (MicroLogic 2) and advanced electronic trip units (MicroLogic 5/6) which offer embedded metering and communication.

Both devices can protect against insulation faults thanks to their embedded earth leakage protection.

ComPact NSXm & NSX can be easily installed at all levels in distribution systems, from main LV switchboard to the subdistribution boards and enclosures.

### Industrial buildings, Machines, Ventilation and Water Treatment

The ComPact NSX range includes a number of versions to protect motor applications:

- basic short-circuit protection with MA magnetic trip units or the electronic MicroLogic 1-M version, combined with an external relay to provide thermal protection

- protection against overloads, short-circuits with additional motor-specific protection (phase unbalance, locked rotor, underload and long start) with MicroLogic 6 E-M trip units.

These versions also offer communication, metering and operating assistance.

The exceptional limiting capacity of ComPact NSX circuit breakers automatically provides type-2 coordination with the motor starter, in compliance with standard IEC 60947-4-1.

### Buildings and Industrial buildings

A switch-disconnector version of ComPact NSXm & NSX circuit breakers is available for circuit control and isolation. All add-on functions of both circuit breakers may be combine with the basic switch-disconnector function.

For information on other switch-disconnector ranges, see the ComPact INS/INV catalog and for fusegear protection see FuPact catalog [a].

### Marine

ComPact NSX HB1/HB2 up to 630 A circuit breakers have the best-in-class breaking capacity for Marine applications (100 kA/690 V).

Devices can be equipped with Thermal Magnetic, basic electronic trip units (MicroLogic 2) and advanced electronic trip units (MicroLogic 5/6) which offer embedded metering and communication.

Standard ComPact NSX breakers AC and DC ranges can be used for military navy inside the main and emergency switchboards [b].

### Special applications

The ComPact NSX range offers a number of versions for special protection applications:

- Service connection to public distribution systems
- Generators
- Industrial control panels
- 16 Hz 2/3 systems
- 400 Hz systems [1].

For all these applications, circuit breakers in the ComPact NSX range offer positive contact indication and are suitable for isolation in accordance with standards IEC 60947-1 and 2.

[1] ComPact NSXm maybe used on 400 Hz systems.

### Photovoltaic

ComPact NSX DC PV range up to 500 A (1000V DC) is the best choice for photovoltaic generation from 10 kW to 500 kW.

Circuit breakers can be used for over-current protection.

Circuit breakers and switches can be used for isolation during maintenance phase

ComPact NSX is part of a Schneider Electric photovoltaic architecture which offers AC and DC protection, control and metering, inverters for DC to AC voltages and PV modules [c].

### Oil & Gas

ComPact NSX up to 630 A offers the Highest breaking capacity in its class mainly required in Oil&Gas industry:

- up to 100 kA at 690 V

- up to 200 kA at 415 V.

Devices can be equipped with Thermal Magnetic, basic electronic trip units (MicroLogic 2) and advanced electronic trip units (MicroLogic 5/6) which offer embedded metering and communication

ComPact NSX range offers outstanding selectivity at 415 V and 690 V [b].

### Critical Power Supplies

ComPact NSX DC range up to 1200 A (5 kA/600 V DC) perfectly meets the requirements of UPS manufacturers keeping the same compact footprint as the standard ComPact NSX range.

Batteries are usually used for emergency power supply and circuit breakers are used to protect the battery circuit (between the battery and the circuit) [c].

To ensure a continuous supply of power, some electrical installations are connected to two power sources [d]:

- a normal source

- a replacement source to supply the installation when the normal source is not available.

A mechanical and/or electrical interlocking system between two circuit breakers or switch-disconnectors avoids all risk of parallel connection of the sources during switching.

A source-changeover system can be:

- manual with mechanical device interlocking

- remote controlled with mechnaical and/or electrical device interlocking

- automatic by adding a controller to manage switching from one source to the other on the basis of external parameters.



# Select your circuit breakers and switch-disconnectors

## Characteristics and performance

ComPact NSXm circuit breakers from 16 to 160 A up to 690 V .... A-2

ComPact NSX circuit breakers from 100 to 250 A up to 690 V ..... A-4

ComPact NSX circuit breakers from 400 to 630 A up to 690 V ..... A-8

ComPact NSXm switch-disconnectors from 50 to 160 A NA ..... A-10

ComPact NSX switch-disconnectors from 100 to 630 A NA..... A-12

General characteristics of the ComPact range ..... A-14

## ComPact NSX special applications

High performances at 690 V ..... A-16



### Other chapters

Select your protection ..... B-1

Customize your circuit breaker with accessories ..... C-1

Smart Panel integration ..... D-1

Switchboard integration ..... E-1

Catalog numbers ..... F-1

Glossary ..... G-1

Additional characteristics ..... H-1

# Characteristics and performance

## ComPact NSXm circuit breakers from 16 to 160 A up to 690 V

 ComPact™ NSXm molded case circuit breaker (MCCB)



ComPact NSXm.

### Common characteristics

Rated voltages	Insulation voltage (V)	Ui	800
	Insulation voltage for ELCB [1] (V)	Ui	500
	Impulse withstand voltage (kV)	Uimp	8
	Operational voltage (V)	Ue AC 50/60 Hz	690
	Operational voltage for ELCB [1] (V)	Ue AC 50/60 Hz	440
Suitability for isolation	IEC/EN 60947-2		yes
Utilisation category			A
Pollution degree	IEC 60664-1		3

### Circuit breakers

#### Breaking capacity levels

#### Breaking capacity (kA rms)

Icu	AC 50/60 Hz	220...240 V
		380...415 V
		440 V
		500 V
		525 V
		660...690 V

#### Service breaking capacity (kA rms)

Ics	AC 50/60 Hz	220...240 V
		380...415 V
		440 V
		500 V
		525 V
		660...690 V

#### Durability (C-O cycles)

#### Mechanical

#### Electrical

440 V	In/2
	In
690 V	In/2
	In

### Protection and measurements

Overload / short-circuit protection	Thermal magnetic
	Electronic with Earth Leakage Protection (ELCB)
Options	Device status/control
	For ELCB [1]: alarming and fault differentiation

### Installation / connections

#### Dimensions and weights

Dimensions (mm)	3P
	4P
W x H x D	ELCB [1]
Weight (kg)	3P
	4P
	ELCB [1]

#### Connections

Pitch (mm)	Standard
	With spreaders
EverLink lug Cu or Al [2] cables	Cross-section (mm <sup>2</sup> )
	Rigid
Crimp lugs Cu or Al	Cross-section (mm <sup>2</sup> )
	Flexible
	Rigid
	Flexible

### Source changeover system

#### Manual mechanical interlocking

[1] ELCB: Earth Leakage Circuit Breaker (MicroLogic Vigi 4.1).

[2] Al up to 100 A.

# Characteristics and performance

ComPact NSXm circuit breakers from 16 to 160 A up to 690 V



## Common characteristics

Control	Manual	With toggle	<input checked="" type="radio"/>
		With direct or extended rotary handle	<input checked="" type="radio"/>
		With side rotary handle	<input checked="" type="radio"/>
Versions	Fixed		<input checked="" type="radio"/>

NSXm up to 63 A						NSXm from 80 to 160 A and ELCB [1]				
E	B	F	N	H		E	B	F	N	H
25	50	85	90	100		25	50	85	90	100
16	25	36	50	70		16	25	36	50	70
10	20	35	50	65		10	20	35	50	65
8	10	15	25	30		-	-	-	-	-
-	-	10	15	22		-	-	-	-	-
-	-	-	10	10		-	-	-	-	-
25	50	85	90	100		25	50	85	90	100
16	25	36	50	70		16	25	36	50	70
10	20	30	50	65		10	20	30	50	65
8	10	10	25	30		-	-	-	-	-
-	-	10	15	22		-	-	-	-	-
-	-	-	2.5	2.5		-	-	-	-	-
20000										
20000										
10000										
10000										
5000										
<input checked="" type="radio"/>						<input checked="" type="radio"/>				
<input checked="" type="radio"/>						<input checked="" type="radio"/>				
<input checked="" type="radio"/>										
81 x 137 x 80										
108 x 137 x 80										
108 x 144 x 80										
1.06										
1.42										
1.63										
27										
35										
95										
70										
120										
95										
<input checked="" type="radio"/>						<input checked="" type="radio"/>				

# Characteristics and performance

## ComPact NSX circuit breakers from 100 to 250 A up to 690 V

A



ComPact NSX single-pole.



ComPact NSX two-pole.

### ComPact circuit breakers

Number of poles		
Control	manual	toggle direct or extended rotary handle
Connections	electric	
	fixed	front connection rear connection
	withdrawable	front connection rear connection

### Electrical characteristics as per IEC/EN 60947-2

Rated current (A)	<b>In</b>	40 °C
Rated insulation voltage (V)	<b>Ui</b>	
Rated impulse withstand voltage (kV)	<b>Uimp</b>	
Rated operational voltage (V)	<b>Ue</b>	AC 50/60 Hz DC

### Type of circuit breaker

Ultimate breaking capacity (kA rms)	<b>Icu</b>	AC	220/240 V
		50/60 Hz	380/415 V 440 V 500/525 V 660/690 V
Service breaking capacity (kA rms)	<b>Ics</b>	DC	250 V (1P) 500 V (2P)
		% Icu	

Suitability for isolation

Utilisation category			
Durability (C-O cycles)	mechanical		
	electrical	277 V	In/2 In

### Protection and measurements

Type of trip units			
Ratings		<b>In</b>	
Overload protection (thermal)	long time threshold	<b>Ir</b>	
Short-circuit protection (magnetic)	instantaneous pickup	<b>Im</b>	value indicated for AC [1] real value for DC
Add-on earth-leakage protection	Vigi add-on combination with Vigirex relay		

### Additional indication and control auxiliaries

Indication contacts	
Voltagages releases	MX shunt release MN undervoltage release

### Installation

Accessories	terminal extensions and spreaders terminal shields and interphase barriers escutcheons
Dimensions (mm)	W x H x D
Weight (kg)	

### Source changeover system

Manual mechanical interlocking

[1] The thresholds for TMD and TMG 1-pole and 2-pole magnetic trip units up to 63 A are indicated for AC. The real DC thresholds are indicated on the following line.

# Characteristics and performance

ComPact NSX circuit breakers from 100 to 250 A up to 690 V



NSX100			NSX160			NSX250		
1		2	1		2	1		
⊙		⊙	⊙		⊙	⊙		⊙
-		-	-		-	-		-
-		-	-		-	-		-
⊙		⊙	⊙		⊙	⊙		⊙
⊙		⊙	⊙		⊙	⊙		⊙
-		-	-		-	-		-
-		-	-		-	-		-
100		100	160		160	250		
750		750	750		750	750		
8		8	8		8	8		
277		690	277		690	277		
250		500	250		500	-		
F N M		F M S	F N M		F M S	N		
18 25 40		36 85 100	18 25 40		36 85 100	25		
- - -		18 25 70	- - -		18 25 70	-		
- - -		15 25 65	- - -		15 25 65	-		
- - -		10 18 35	- - -		10 18 35	-		
- - -		5 8 10	- - -		5 8 10	-		
36 50 85		36 85 100	36 50 85		36 85 100	-		
- - -		36 85 100	- - -		36 85 100	-		
100 %		100 %	100 %		100 %	100 %		
⊙		⊙	⊙		⊙	⊙		
A		A	A		A	A		
20000		20000	20000		20000	10000		
20000		20000	20000		20000	10000		
10000		10000	10000		10000	5000		
built-in thermal-magnetic		built-in thermal-magnetic			built-in thermal-magnetic			built-in thermal-magnetic
16 20 25 30 40		50 63 80 100	125 160		160 200 250			160 200 250
fixed		50 63 80 100	fixed		fixed			fixed
16 20 25 30 40		50 63 80 100	125 160		160 200 250			160 200 250
fixed		500 500 640 800	fixed		fixed			fixed
190 190 300 300 500		700 700 800 1000	1000 1250		850 850 850			850 850 850
260 260 400 400 700		-	1200 1250		- - -			- - -
-		⊙	-		-			-
-		-	-		⊙			-
-		⊙	-		⊙			-
-		⊙	-		⊙			-
⊙		⊙	⊙		⊙			⊙
⊙		⊙	⊙		⊙			⊙
⊙		⊙	⊙		⊙			⊙
35 x 161 x 86		70 x 161 x 86	35 x 161 x 86		70 x 161 x 86			35 x 161 x 86
0.7		1.2	0.7		1.2			0.7
⊙		⊙	⊙		⊙			⊙

# Characteristics and performance

## ComPact NSX circuit breakers from 100 to 250 A up to 690 V

 ComPact NSX" MCCB from "Schneider electric"



ComPact NSX100/160/250.



ComPact NSX250 R.



ComPact NSX250 HB2.

[1] OSN: Over Sized Neutral protection for neutrals carrying high currents (e.g. 3rd harmonics).

[2] ZSI: Zone Selective Interlocking using pilot wires.

[3] Vigi add-on is not available for breaking capacity levels HB1/HB2.

[4] There is no 160 A frame, use 250 A frame with lower rating trip units for R, HB1, HB2.

[5] 2P circuit breaker in 3P case for B and F types, only with thermal-magnetic trip unit.

[6] Earth Leakage Circuit Breaker (MicroLogic Vigi 4.2 and 7.2 E).

### Common characteristics

Rated voltages	Insulation voltage (V)	Ui	800
	Insulation voltage for ELCB [6]	Ui	500
	Impulse withstand voltage (kV)	Uimp	8
	Operational voltage (V)	Ue	AC 50/60 Hz 690
	Operation voltage for ELCB [6]	Ue	AC 50/60 Hz 440
Suitability for isolation	IEC/EN 60947-2		yes
Utilisation category			A
Pollution degree	IEC 60664-1		3

### Circuit breakers

#### Breaking capacity levels

#### Electrical characteristics as per IEC/EN 60947-2

Rated current (A)	In	40 °C
Number of poles		

#### Breaking capacity (kA rms)

	Icu	AC 50/60 Hz	220/240 V
			380/415 V
			440 V
			500 V
			525 V
			660/690 V

#### Service breaking capacity (kA rms)

	Ics	AC 50/60 Hz	220/240 V
			380/415 V
			440 V
			500 V
			525 V
			660/690 V

Durability (C-O cycles)	Mechanical		
		Electrical	440 V
	Electrical	690 V	In/2

#### Characteristics as per UL 508

Breaking capacity (kA rms)	AC 50/60 Hz	240 V
		480 V
		600 V

#### Protection and measurements

Short-circuit protection	Magnetic only
Overload / short-circuit protection	Thermal magnetic
	Electronic
	with neutral protection (Off-0.5-1-OSN) [1]
	with ground-fault protection
	with zone selective interlocking (ZSI) [2]

Display / I, U, f, P, E, THD measurements / interrupted-current measurement

Options	Power Meter display on door
	Operating assistance
	Counters
	Histories and alarms
	Metering Com
	Device status/control Com

Earth-leakage protection	By Vigi add-on [3]
	By Vigi relay

#### Installation / connections

#### Dimensions and weights

Dimensions (mm)	Fixed, front connections	2/3P
	W x H x D	4P
Weight (kg)	Fixed, front connections	2/3P
		4P

#### Connections

Connection terminals	Pitch	With/without spreaders
Large Cu or Al cables	Cross-section	mm <sup>2</sup>

#### Source-changeover system

Manual mechanical interlocking	
Automatic source-changeover	





# Characteristics and performance

## ComPact NSX circuit breakers from 400 to 630 A up to 690 V

A

PB1108106.eps



ComPact NSX400/630.

PB111001.eps



ComPact NSX630 R.

PB111013.eps



ComPact NSX630 HB2.

[1] OSN: Over Sized Neutral protection for neutrals carrying high currents (e.g. 3rd harmonics).

[2] ZSI: Zone Selective Interlocking using pilot wires.

[3] Vigi add-on is not available for breaking capacity levels HB1/HB2.

[4] Earth Leakage Circuit Breaker (MicroLogic Vigi 4.3 and 7.3 E)

### Common characteristics

Rated voltages	Insulation voltage (V)	Ui	800
	Insulation voltage for ELCB [4]		500
	Impulse withstand voltage (kV)	Uimp	8
	Operational voltage (V)	Ue AC 50/60 Hz	690
	Operation voltage for ELCB [4]	Ue AC 50/60 Hz	440
Suitability for isolation		IEC/EN 60947-2	yes
Utilisation category			A
Pollution degree		IEC 60664-1	3

### Circuit breakers

#### Breaking capacity levels

#### Electrical characteristics as per IEC/EN 60947-2

Rated current (A)	In	40 °C
-------------------	----	-------

Number of poles

#### Breaking capacity (kA rms)

Icu	AC 50/60 Hz	220/240 V
		380/415 V
		440 V
		500 V
		525 V
		660/690 V

#### Service breaking capacity (kA rms)

Ics	AC 50/60 Hz	220/240 V
		380/415 V
		440 V
		500 V
		525 V
		660/690 V

Durability (C-O cycles)

Mechanical	Electrical	440 V	In/2
			In
		690 V	In/2
			In

#### Characteristics as per UL 508

Breaking capacity (kA rms)	AC 50/60 Hz	240 V
		480 V
		600 V

#### Protection and measurements

Short-circuit protection	Magnetic only
Overload / short-circuit protection	Thermal magnetic
	Electronic
	with neutral protection (Off-0.5-1-OSN) [1]
	with ground-fault protection
	with zone selective interlocking (ZSI) [2]
Display / I, U, f, P, E, THD measurements / interrupted-current measurement	

Options

Power Meter display on door
Operating assistance
Counters
Histories and alarms
Metering Com
Device status/control Com

Earth-leakage protection

By Vigi add-on [3]
By Vigirex relay

#### Installation / connections

#### Dimensions and weights

Dimensions (mm) W x H x D	Fixed, front connections	2/3P
		4P
Weight (kg)	Fixed, front connections	2/3P
		4P

#### Connections

Connection terminals	Pitch	With/without spreaders
----------------------	-------	------------------------

Large Cu or Al cables	Cross-section	mm <sup>2</sup>
-----------------------	---------------	-----------------

#### Source-changeover system

Manual mechanical interlocking

Automatic source-changeover

# Characteristics and performance

## ComPact NSX circuit breakers from 400 to 630 A up to 690 V



### Common characteristics

Control	Manual	With toggle	<input type="radio"/>
		With direct or extended rotary handle	<input type="radio"/>
Versions	Electrical	With remote control	<input type="radio"/>
	Fixed		<input type="radio"/>
	Withdrawable	Plug-in base	<input type="radio"/>
		Chassis	<input type="radio"/>

NSX400									NSX630								
--------	--	--	--	--	--	--	--	--	--------	--	--	--	--	--	--	--	--

																		I <sub>r</sub> = 225 - 500 A			I <sub>r</sub> = 501 - 630 A					
F	N	H	S	L	R	HB1	HB2		F	N	H	S	L	R	HB1	HB2		R	HB1	HB2	R	HB1	HB2			
<b>400</b>					<b>400</b>					<b>630</b>					<b>630</b>											
3, 4					3, 4					3, 4					3, 4											
40	85	100	120	150	200	-	-		40	85	100	120	150	200	-	-		200	-	-	200	-	-	200	-	-
36	50	70	100	150	200	-	-		36	50	70	100	150	200	-	-		200	-	-	200	-	-	200	-	-
30	42	65	90	130	200	-	-		30	42	65	90	130	200	-	-		200	-	-	200	-	-	200	-	-
25	30	50	65	70	80	85	100		25	30	50	65	70	80	85	100		80	85	100	80	85	100	80	85	100
20	22	35	40	50	65	80	100		20	22	35	40	50	65	80	100		65	80	100	65	80	100	65	80	100
10	10	20	25	35	45	75	100		10	10	20	25	35	45	75	100		45	75	100	45	75	100	45	75	100
40	85	100	120	150	200	-	-		40	85	100	120	150	200	-	-		200	-	-	200	-	-	200	-	-
36	50	70	100	150	200	-	-		36	50	70	100	150	200	-	-		200	-	-	200	-	-	200	-	-
30	42	65	90	130	200	-	-		30	42	65	90	130	200	-	-		200	-	-	200	-	-	200	-	-
25	30	50	65	70	80	85	100		25	30	50	65	70	80	85	100		80	85	100	80	85	100	80	85	100
10	11	11	12	12	65	80	100		10	11	11	12	12	65	80	100		65	80	100	-	-	-	-	-	-
10	10	10	12	12	45	75	100		10	10	10	12	12	45	75	100		45	75	100	-	-	-	-	-	-
15000					15000					15000					15000											
12000					12000					8000					8000											
6000					6000					4000					4000											
6000					6000					6000					6000											
3000					3000					2000					2000											
85	85	85	-	-	-	-	-		85	85	85	-	-	-	-	-		-	-	-	-	-	-	-	-	-
35	50	65	-	-	-	-	-		35	50	65	-	-	-	-	-		-	-	-	-	-	-	-	-	-
20	10	20	-	-	-	-	-		20	20	20	-	-	-	-	-		-	-	-	-	-	-	-	-	-

<input type="radio"/>	<input type="radio"/>
-	-
<input type="radio"/>	<input type="radio"/>
<input type="radio"/>	<input type="radio"/>
<input type="radio"/>	<input type="radio"/>
<input type="radio"/>	<input type="radio"/>
<input type="radio"/>	<input type="radio"/>
<input type="radio"/>	<input type="radio"/>
<input type="radio"/>	<input type="radio"/>
<input type="radio"/>	<input type="radio"/>
<input type="radio"/>	<input type="radio"/>
<input type="radio"/>	<input type="radio"/>
<input type="radio"/>	<input type="radio"/>
<input type="radio"/>	<input type="radio"/>
<input type="radio"/>	<input type="radio"/>
<input type="radio"/>	<input type="radio"/>
<input type="radio"/>	<input type="radio"/>
<input type="radio"/>	<input type="radio"/>
<input type="radio"/>	<input type="radio"/>

140 x 255 x 110	140 x 255 x 110
185 x 255 x 110	185 x 255 x 110
6.05	6.2
7.90	8.13

45/52.5 mm	45/52.5 mm
45/70 mm	45/70 mm
4 x 240	4 x 240

<input type="radio"/>	<input type="radio"/>
<input type="radio"/>	<input type="radio"/>

# Characteristics and performance

## ComPact NSXm switch-disconnectors from 50 to 160 A NA

Installation standards require upstream protection. However ComPact NSXm 50 to 160 NA switch-disconnectors are self-protected by their high-set magnetic release.

A



ComPact NSXm switch-disconnectors.

### Common characteristics

Rated voltages	Insulation voltage (V)	Ui	800
	Impulse withstand voltage (kV)	Uimp	8
	Operational voltage (V)	Ue	AC 50/60 Hz 690
Suitability for isolation		IEC/EN 60947-3	yes
Utilisation category		AC 22 A/AC 23 A	
Pollution degree		IEC 60664-1	3

### Switch-disconnectors

#### Electrical characteristics as per IEC/EN 60947-3

Conventional thermal current (A) Ith 40 °C

Number of poles

Operational current (A) depending on the utilisation category	le	AC 50/60 Hz	220/240 V
			380/415 V
			440/480 V
			500/525 V
			660/690 V

Short-circuit making capacity (kA peak)	Icm	min. (switch-disconnector alone) max. (protection by upstream circuit breaker)
---	-----	---

Rated short-time withstand current (A rms)	Icw	for	1 s
			3 s
			20 s

Durability (C-O cycles)	mechanical		
	electrical	AC	
		440 V	Ie/2
		690 V	Ie
			Ie/2
			Ie

Positive contact indication

Pollution degree

#### Additional indication and control auxiliaries

Indication contacts

Voltage releases	MX shunt trip release
	MN undervoltage release

#### Installation / connections

##### Dimensions and weights

Dimensions (mm)	3P
W x H x D	4P
Weight (kg)	3P
	4P

##### Connections

Pitch (mm)	Standard
	With spreaders
EverLink lug Cu or Al [1] cables	Cross-section (mm²)
	Rigid
	Flexible
Crimp lugs Cu or Al	Cross-section (mm²)
	Rigid
	Flexible

#### Source-changeover systems

Manual mechanical interlocking

[1] Al up to 100 A.

# Characteristics and performance

## ComPact NSXm switch-disconnectors from 50 to 160 A NA



### Common characteristics

Control	Manual	With toggle	<input checked="" type="radio"/>
		With direct or extended rotary handle	<input checked="" type="radio"/>
		With side rotary handle	<input checked="" type="radio"/>
Versions	Fixed		<input checked="" type="radio"/>

	NSXm50NA	NSXm100NA	NSXm160NA
	<b>50</b>	<b>100</b>	<b>160</b>
	3, 4	3, 4	3, 4
	<b>AC22A / AC23A</b>	<b>AC22A / AC23A</b>	<b>AC22A / AC23A</b>
	50	100	160 / 100
	50	100	160 / 100
	50	100	160 / 100
	50	100	160 / 100
	50	100	160 / 100
	1.28	2.13	2.13
	150	150	150
	900	1500	1500
	900	1500	1500
	200	335	335
	20000	20000	20000
	<b>AC22A / AC23A</b>	<b>AC22A / AC23A</b>	<b>AC22A / AC23A</b>
	20000 / 20000	20000 / 20000	20000 / 20000
	10000 / 10000	10000 / 10000	10000 / 10000
	10000 / 6000	10000 / 6000	10000 / 6000
	5000 / 3000	5000 / 3000	5000 / 3000
	<input checked="" type="radio"/>	<input checked="" type="radio"/>	<input checked="" type="radio"/>
	3	3	3
	<input checked="" type="radio"/>	<input checked="" type="radio"/>	<input checked="" type="radio"/>
	<input checked="" type="radio"/>	<input checked="" type="radio"/>	<input checked="" type="radio"/>
	<input checked="" type="radio"/>	<input checked="" type="radio"/>	<input checked="" type="radio"/>

	81 x 137 x 80
	108 x 137 x 80
	1.06
	1.42

	27
	35
	95
	70
	120
	95
	<input checked="" type="radio"/>

# Characteristics and performance

## ComPact NSX switch-disconnectors from 100 to 630 A NA

Installation standards require upstream protection. However ComPact NSX100 to 630 NA switch-disconnectors are self-protected by their high-set magnetic release.

A



ComPact NSX100 to 250 NA.



ComPact NSX400 to 630 NA.

> Discover our specific switch-disconnectors offer: ComPact INS/INV



LVPED213024EN

[1] 2P in 3P case.

### Common characteristics

Rated voltages	Insulation voltage (V)	Ui	800
	Impulse withstand voltage (kV)	Uimp	8
	Operational voltage (V)	Ue	AC 50/60 Hz 690
Suitability for isolation		IEC/EN 60947-3	yes
Utilisation category		AC 22 A/AC 23 A - DC 22 A/DC 23 A	
Pollution degree		IEC 60664-1	3

### Switch-disconnectors

#### Electrical characteristics as per IEC/EN 60947-3

Conventional thermal current (A)	Ith 60 °C		
Number of poles			
Operational current (A) depending on le the utilisation category		AC 50/60 Hz	
			220/240 V
			380/415 V
			440/480 V
			500/525 V
			660/690 V
		DC	
			250 V (1 pole)
			500 V (2 poles in series)
			750 V (3 poles in series)
Short-circuit making capacity (kA peak)	Icm	min. (switch-disconnector alone)	
		max. (protection by upstream circuit breaker)	
Rated short-time withstand current (A rms)	Icw	for	1 s
			3 s
			20 s
Durability (C-O cycles)	mechanical		
	electrical	AC	
			440 V In/2
			690 V In
			In/2
			In
		DC	
			250 V (1 pole) and In/2
			500 V (2 poles in series) In

Positive contact indication

Pollution degree

#### Protection

Add-on earth-leakage protection By Vigi add-on

By Vigiex relay

#### Additional indication and control auxiliaries

Indication contacts

Voltages releases MX shunt release

MN undervoltage release

Voltage-presence indicator

Current-transformer module

Ammeter module

Insulation monitoring module

#### Remote communication by bus

Device-status indication

Device remote operation

Operation counter

#### Installation / connections

Dimensions (mm) fixed, front connections 2/3P

W x H x D 4P

Weight (kg) fixed, front connections 3P

4P

#### Source-changeover systems (see chapter on Source-changeover systems)

Manual mechanical interlocking

Automatic source-changeover



# General characteristics of the ComPact range

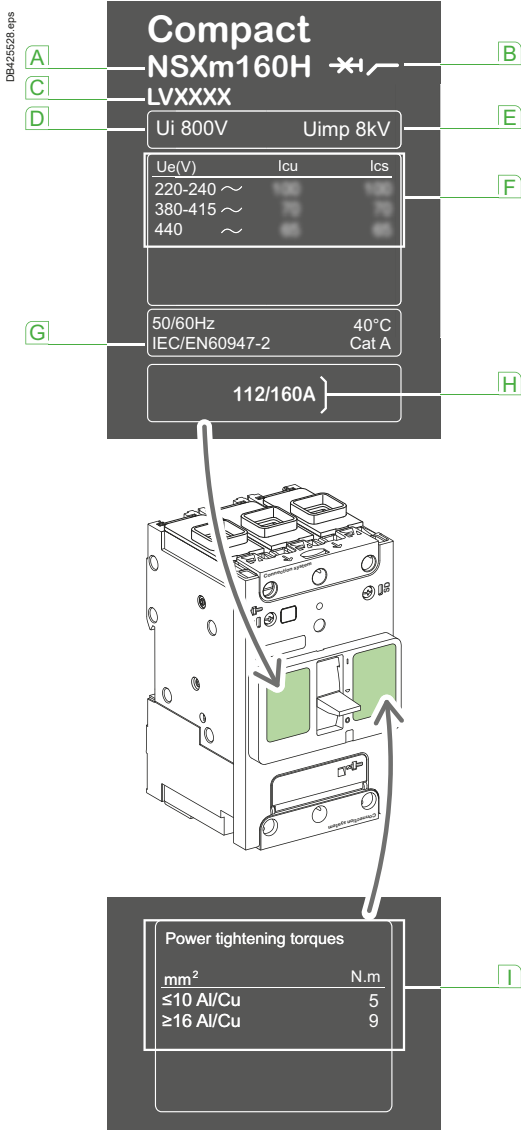

Standardised characteristics indicated on the rating plate:

- A** Type of device: frame size and breaking capacity class
- B** Circuit breaker/switch-disconnector symbol.
- C** Commercial reference.
- D** Ui: rated insulation voltage.
- E** Uimp: rated impulse withstand voltage.
- F** Ue: operational voltage.
- G** Reference standard.
- H** Circuit breaker rating.
- I** Power connections tightening torques.

**Note:** when the circuit breaker is equipped with an extended rotary handle, the door must be opened to access the rating plate.

## Compliance with standards

ComPact NSX and NSXm circuit breakers and switch-disconnectors comply with the following:

- international standards:
  - IEC 60947-1: general rules
  - IEC 60947-2: circuit breakers
  - IEC 60947-3: switch-disconnectors
  - IEC 60947-4-1: contactors and motor starters [1]
  - IEC 60947-5-1 and following: control circuit devices and switching elements; automatic control components
- European standards (EN 60947-1, EN 60947-2, EN 60947-3 and EN 60947-5-1):
  - China CCC
  - EAC (Customs Union)
- the specifications of the marine classification companies (Veritas, Lloyd's Register of Shipping, Det Norske Veritas, etc.), recommendations issued by the CNOMO organisation for the protection of machine tools.

## Pollution degree

ComPact NSX and NSXm circuit breakers and switch-disconnectors are certified for operation in pollution degree 3 environments as defined by IEC standards 60947-1 and 60664-1 (industrial environments).

## Climatic withstand

ComPact NSX and NSXm circuit breakers have successfully passed the tests defined by the following standards for extreme atmospheric conditions.

Dry cold and dry heat:

- IEC 60068-2-1: dry cold at -55 °C
- IEC 60068-2-2: dry heat at +85 °C.

Damp heat (tropicalization)

- IEC 60068-2-30: damp heat (temperature + 55 °C and relative humidity of 95 %).
- IEC 60068-2-52: severity 2 - Cycling salt mist.

## Environment

ComPact NSX and NSXm respects the European environment directive EC/2002/95 concerning the restriction of hazardous substances (RoHS) and is Green Premium. Product environment profiles (PEP) have been prepared, describing the environmental impact of every product throughout its life cycle, from production to the end of its service life.

All ComPact production sites have set up an environmental management system certified ISO 14001.

Each factory monitors the impact of its production processes. Every effort is made to prevent pollution and to reduce consumption of natural resources.

## Ambient temperature

■ ComPact NSX and NSXm circuit breakers may be used between -25 °C and +70 °C. For temperatures higher than 40 °C, (For ComPact NSX: +65 °C for circuit breakers used to protect motor feeders) devices must be derated (pages E-8 to E-9 and E-14 to E-17).

■ Circuit breakers should be put into service under normal ambient, operating-temperature conditions. Exceptionally, the circuit breaker may be put into service when the ambient temperature is between -35 °C and -25 °C.

■ The permissible storage temperature range for ComPact NSX and NSXm circuit breakers in the original packing is -50 °C [2] [3] and +85 °C.

[1] For ComPact NSX

[2] For ComPact NSXm: -40 °C for ComPact NSXm MicroLogic Vigi 4.1.

[3] For ComPact NSX: -40 °C for MicroLogic control units with an LCD screen and MicroLogic Vigi 4.





# Select your circuit breakers and switch-disconnectors

## General characteristics of the ComPact range

### Electromagnetic compatibility

ComPact NSX and NSXm devices are protected against:

- overvoltages caused by circuit switching (e.g. lighting circuits)
- overvoltages caused by atmospheric disturbances
- devices emitting radio waves such as mobile telephones, radios, walkie-talkies, radar, etc.
- electrostatic discharges produced by users.

Immunity levels for ComPact NSXm comply with the standards below.

- IEC/EN 60947-2: Low-voltage switchgear and controlgear, part 2: Circuit breakers:
  - Annex F: Immunity tests for circuit breakers with electronic protection
  - Annex B: Immunity tests for residual current protection
- IEC/EN 61000-4-2: Electrostatic-discharge immunity tests
- IEC/EN 61000-4-3: Radiated, radio-frequency, electromagnetic-field immunity tests
- IEC/EN 61000-4-4: Electrical fast transient/burst immunity tests
- IEC/EN 61000-4-5: Surge immunity tests
- IEC/EN 61000-4-6: Immunity tests for conducted disturbances induced by radio-frequency fields
- IEC/EN 61000-4-8: Power frequency magnetic field immunity test
- IEC/EN 61000-4-11: Voltage dips, short interruptions and voltage variations immunity tests
- CISPR 11: Industrial, scientific and medical equipment - Radio-frequency disturbance characteristics - Limits and methods of measurement.

### Suitable for isolation with positive contact indication

All ComPact NSX and NSXm devices are suitable for isolation as defined in IEC standard 60947-2:

- The isolation position corresponds to the O (OFF) position.
- The operating handle cannot indicate the OFF position unless the contacts are effectively open.
- Padlocks may not be installed unless the contacts are open.

Installation of a rotary handle or a motor mechanism does not alter the reliability of the position-indication system.

The isolation function is certified by tests guaranteeing:

- the mechanical reliability of the position-indication system
- the absence of leakage currents
- overvoltage withstand capacity between upstream and downstream connections.

The tripped position does not insure isolation with positive contact indication.

Only the OFF position guarantees isolation.

### Installation in class II switchboards

All ComPact NSX and NSXm devices are class II front face devices. They may be installed through the door of class II switchboards (as per IEC standards 61140 and 60664-1) without downgrading switchboard insulation. Installation requires no special operations, even when the circuit breaker is equipped with a rotary handle or a motor mechanism.

### Degree of protection

The following indications are in accordance with standards IEC 60529 (IP degree of protection) and IEC 62262 (IK protection against external mechanical impacts).

#### Bare circuit breaker with terminal shields

- With toggle: IP40, IK07.
- With direct rotary handle: IP40 IK07.

#### Circuit breaker installed in a switchboard

##### ComPact NSXm

- With toggle: IP40, IK07.
- With direct rotary handle: IP40, IK07.
- With extended rotary handle: IP54 or IP65 IK08
- With side rotary handle: IP54 or IP65 IK08.

##### ComPact NSX

- With toggle: IP40, IK07.
- With direct rotary handle:
  - standard / VDE: IP40, IK07
  - MCC: IP43 IK07
  - CNOMO: IP54 IK08
- With extended rotary handle: IP55 IK08
- With motor mechanism: IP40 IK07.

For more detail about IP, see [page E-7](#).

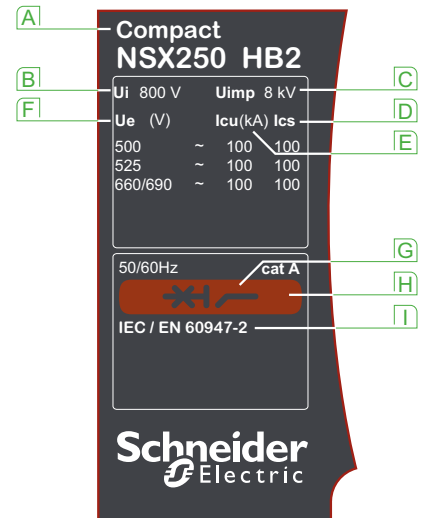

Standardised characteristics indicated on the rating plate:

- A** Type of device: frame size and breaking capacity class
- B** Ui: rated insulation voltage.
- C** Uimp: rated impulse withstand voltage.
- D** Ics: service breaking capacity.
- E** Icu: ultimate breaking capacity for various values of the rated operational voltage Ue
- F** Ue: operational voltage.
- G** Circuit breaker/switch-disconnector symbol.
- H** Colour label indicating the breaking capacity class.
- I** Reference standard.

**Note:** when the circuit breaker is equipped with an extended rotary handle, the door must be opened to access the rating plate.

# ComPact NSX special applications

## High performances at 690 V

ComPact NSX R/HB1/HB2 circuit breaker is designed specifically for the needs of systems operating at 690 V.

A



ComPact NSX100 to 250.



ComPact NSX400 to 630.

### Markets

- Marine.
- Oil and gas.
- Data centers.
- Other markets pursuing energy efficiency (water, industrial, etc.).

### Ability to service high power densities

- Upgrade voltage from ~415-440 to 690 V system allows:
  - smaller cables can be used
  - reduced cost and space
  - reduced energy loss in transmission
- motors are more efficient at 690 V.
- Consider 690 V as an alternative MV system:
  - lower cost, smaller footprint, and improved maintenance.

### Safety

- IACS (International Association of Classification Societies) change, requires Ics rating for emergency systems:
  - key influence on Marine systems of high Ics ratings
  - continuity of service after 3 faults.

### Technology

- Best in class technology and performance:
  - high breaking capacity
  - NSX family consistency of energy metering, alarming and diagnosis.
- Provides alternative to fuse protection at 690 V applications.

### Enhancing solutions

- Using smaller frames for 690 V high performance circuits:
  - space and cost benefit
  - NSX family consistency with same NSX accessories.
- 200 kA breaking capacity on R rating will be mainly used for:
  - high power factor applications : around 2.8 instead of 2.2
  - selectivity with MasterPact UR.

### Type I & II coordination for motor applications

- Type I & II coordination with Tesys contactors is available up to 690 V.
- Coordination tables are prepared with external overload relays and protection integrated into the MicroLogic trip units.
- See complementary bulletin for ratings.

### Compliance with standards

ComPact NSX circuit breakers and auxiliaries comply with the following:

- international recommendations:
  - IEC 60947-1: general rules
  - IEC 60947-2: circuit breakers
  - IEC 60947-3: switch-disconnectors
  - IEC 60947-4: contactors and motor starters
  - IEC 60947-5.1 and following: control circuit devices and switching elements; automatic control components
- European (EN 60947-1, EN 60947-2, EN 60947-3 and EN 60947-5.1) and corresponding national standards:
  - China CCC
  - EAC (Customs Union)
  - the specifications of the marine classification companies (Veritas, Lloyd's Register of Shipping, Det Norske Veritas, etc.), recommendations issued by the CNOMO organisation for the protection of machine tools.

# ComPact NSX special applications

High performances at 690 V



Circuit breakers			NSX100-250 [1]			NSX400			NSX630					
Breaking capacity levels			R	HB1	HB2	R	HB1	HB2	R	HB1	HB2	R	HB1	HB2
<b>Electrical characteristics</b>														
<b>Breaking capacity (kA rms)</b>									I <sub>r</sub> < 500 A			I <sub>r</sub> > 501 A		
I <sub>cu</sub> AC 50/60 Hz	220/240 V		200	-	-	200	-	-	200	-	-	200	-	-
	380/415 V		200	-	-	200	-	-	200	-	-	200	-	-
	440 V		200	-	-	200	-	-	200	-	-	200	-	-
	500 V		80	85	100	80	85	100	80	85	100	80	85	100
	525 V		65	80	100	65	80	100	65	80	100	65	80	100
	690 V		45	75	100	45	75	100	45	75	100	45	75	100
<b>Service breaking capacity (kA rms)</b>									I <sub>r</sub> < 500 A			I <sub>r</sub> > 501 A		
I <sub>cs</sub> AC 50/60 Hz	220/240 V		200	-	-	200	-	-	200	-	-	200	-	-
	380/415 V		200	-	-	200	-	-	200	-	-	200	-	-
	440 V		200	-	-	200	-	-	200	-	-	200	-	-
	500 V		80	85	100	80	85	100	80	85	100	80	85	100
	525 V		65	80	100	65	80	100	65	80	100	-	-	-
	690 V		45	75	100	45	75	100	45	75	100	-	-	-

[1] There is no 160 A frame, use the 250 A frame with lower rating trip units.



## Offer structure

The ComPact NSX HB offer has some differences compared to the standard NSX offer.

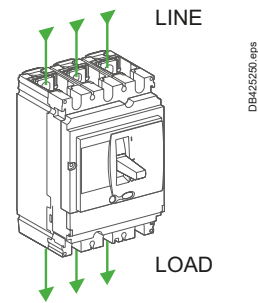
- 100 A frame and 250 A frame, there is no 160 A frame. The 125 - 160 A trip units are used in a 250 A frame.
- All R, HB1 and HB2 circuit breakers are restricted for use as line-load connection. They can not have power fed from the bottom of the circuit breaker. They will be marked with Line and Load markings.
- ComPact NSX400-630 R/HB1/HB2, U > 440 V, I<sub>cu</sub> 20 kA, Line/Load connection possible with insulation screen.
- All trip units will be assembled in the factory.



For breaking capacities R/HB1/HB2.

Type of protection	Distribution protection		Motor protection	
	TMD	MicroLogic	MA	MicroLogic
 PB110406_40 eps	ComPact NSX100	40-100	2.2: 40-100 5.2 E: 40-100 6.2 E: 40-100	12.5-100  2.2 M: 25, 50, 100 6.2 E-M: 25, 50, 100
	ComPact NSX250	125-250	2.2: 100, 160, 250 5.2 E: 100, 160, 250 6.2 E: 100, 160, 250	150, 220  2.2 M: 150, 220 6.2 E-M: 150, 220
 PB111001 eps	ComPact NSX400	-	2.3: 250, 400 5.3 E: 250, 400 6.3 E: 250, 400	-  1.3 M: 320 2.3 M: 320 6.3 M: 320
	ComPact NSX630	-	2.3: 630 5.3 E: 630 6.3 E: 630	-  1.3 M: 500 2.3 M: 500 6.3 M: 500

> Substitution and technical guide  
ComPact NSX high performances



LVPED508025EN

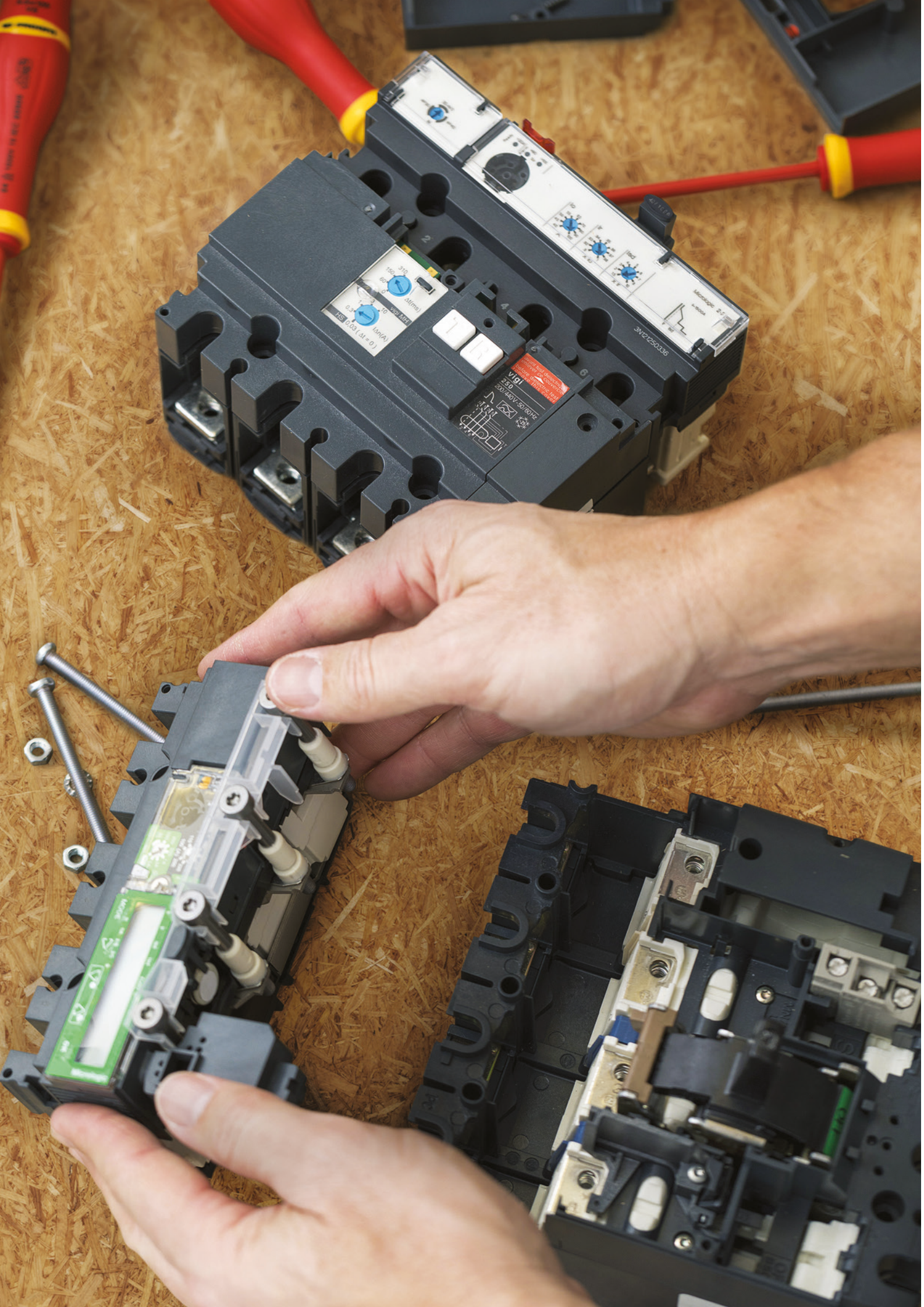

# Select your protection

- Overview of trip units..... B-2
- Protection of distribution systems**
  - ComPact NSXm TM thermal-magnetic trip units ..... B-4
  - ComPact NSX TM thermal-magnetic and MA magnetic trip units B-6
  - Overview of functions..... B-8
  - ComPact NSXm + NSX circuit breakers trip units..... B-9
  - ComPact NSX MicroLogic 2 and 1.3 trip units ..... B-10
  - ComPact NSX MicroLogic 5 / 6 A or E trip units ..... B-12
  - ComPact NSXm MicroLogic Vigi 4.1 trip unit..... B-14
  - ComPact NSX MicroLogic Vigi 4 trip unit ..... B-16
  - ComPact NSX MicroLogic Vigi 7 E trip unit..... B-18
  - ComPact NSX MicroLogic Vigi 7 E trip unit..... B-20
  - ComPact NSX Vigi add-on protection against insulation faults ... B-22
- ComPact NSX motor protection**
  - General information on motor feeders..... B-26
  - Motor-feeder characteristics and solutions ..... B-28
  - Motor-feeder solutions ..... B-29
  - MA instantaneous trip units ..... B-30
  - MicroLogic 1.3 M instantaneous trip units ..... B-31
  - MicroLogic 2.2 / 2.3 M electronic trip units ..... B-32
  - MicroLogic 6 E-M electronic trip units..... B-34
- ComPact NSX measurement**
  - MicroLogic 5 / 6 / 7 E electronic trip units ..... B-38
- ComPact NSX diagnostics & maintenance**
  - MicroLogic 5 / 6 / 7 A or E electronic trip units ..... B-44
- ComPact NSX special applications**
  - Protection of public distribution systems with MicroLogic 2-AB .. B-45
  - ComPact NSX MicroLogic Vigi 4-AB trip unit with embedded earth leakage protection..... B-48
  - Generator protection with MicroLogic 2.2 G..... B-50
  - Protection of industrial control panels..... B-52
  - 16 Hz 2/3 network protection - MicroLogic 5 A-Z trip unit..... B-54
  - Protection of 400 Hz systems..... B-55







Other chapters	
Select your circuit breakers and switch-disconnectors .....	A-1
Customize your circuit breaker with accessories .....	C-1
Smart Panel integration.....	D-1
Switchboard integration .....	E-1
Catalog numbers .....	F-1
Glossary .....	G-1
Additional characteristics .....	H-1

# Select your protection

## Overview of trip units

ComPact NSXm has a built-in trip unit.

B

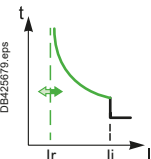
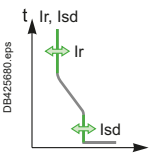
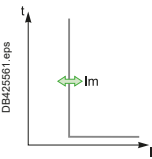
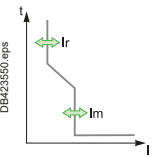
	ComPact NSXm up to 160 A		ComPact NSX up to 250 A	
				
	<b>TM-D distribution</b>	<b>MicroLogic Vigi 4.1 Distribution and earth leakage protection</b>	<b>MA Distribution and motors</b>	<b>TM-D distribution TM-G generators</b>
				
Settings & indications	Pick-up set in amps using dials Non-adjustable time delay			
Front indication	<input checked="" type="checkbox"/>	<input checked="" type="checkbox"/>	<input checked="" type="checkbox"/>	<input checked="" type="checkbox"/>
Test connector		<input checked="" type="checkbox"/>		
Self test	<input checked="" type="checkbox"/>	<input checked="" type="checkbox"/>	<input checked="" type="checkbox"/>	<input checked="" type="checkbox"/>
<b>Measurements</b>				
Amps				
Power				
<b>Diagnostic &amp; Maintenance</b>				
Status indication	<input checked="" type="checkbox"/>	<input checked="" type="checkbox"/>	<input checked="" type="checkbox"/>	<input checked="" type="checkbox"/>
Operating assistance				
<b>Control</b>				
Voltage release	<input checked="" type="checkbox"/>	<input checked="" type="checkbox"/>	<input checked="" type="checkbox"/>	<input checked="" type="checkbox"/>
Motor mechanism			<input checked="" type="checkbox"/>	<input checked="" type="checkbox"/>
<b>Communication</b>				
Modbus SL			<input checked="" type="checkbox"/>	<input checked="" type="checkbox"/>
Ethernet			<input checked="" type="checkbox"/>	<input checked="" type="checkbox"/>
Local display			<input checked="" type="checkbox"/>	<input checked="" type="checkbox"/>
<b>Input / Output control</b>				
SDx		<input checked="" type="checkbox"/>		
I/O module			<input checked="" type="checkbox"/>	<input checked="" type="checkbox"/>
<b>Earth Leakage</b>				
Integrated protection		<input checked="" type="checkbox"/>		
Vigi Add-on module			<input checked="" type="checkbox"/>	<input checked="" type="checkbox"/>
External relay	<input checked="" type="checkbox"/>		<input checked="" type="checkbox"/>	<input checked="" type="checkbox"/>

[1] Only for MicroLogic 6 electronic.

[2] Only for MicroLogic E.



Select your protection

# Protection of distribution systems

## ComPact NSXm TM thermal-magnetic trip units

ComPact NSXm has a built-in thermal magnetic trip units.



ComPact NSXm 160.

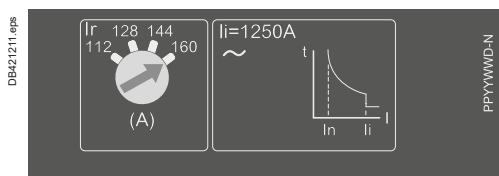

### TM-D thermal-magnetic trip units

Circuit breakers equipped with thermal-magnetic trip units are used mainly in industrial and commercial electrical distribution applications for protection of cables on distribution systems supplied by transformers.

#### Protection

##### Thermal protection ( $I_r$ )

Thermal overload protection based on a bimetal strip providing an inverse time curve  $I^2t$ , corresponding to a temperature rise limit. Above this limit, the deformation of the strip trips the circuit breaker operating mechanism.

This protection operates according to:

- $I_r$  that can be adjusted in amps from 0.7 to 1 times the rating of the circuit breaker (16 A to 160 A), corresponding to settings from 11 to 160 A for the range of products
- a non-adjustable time delay, defined to ensure protection of the cables.

##### Magnetic protection ( $I_m$ )

Short-circuit protection with a fixed pick-up  $I_m$  that initiates instantaneous tripping if exceeded with a non adjustable time delay to ensure selectivity and cascading.

##### Protection versions

- 3-pole:
- 3P 3D: 3-pole frame (3P) with detection on all 3 poles (3D).
- 4-pole:
- 4P 3D: 4-pole frame (4P) with detection on 3 poles (3D).
- 4P 4D: 4-pole frame (4P) with detection on all 4 poles (same threshold for phases and neutral).

**Note:** All the circuit breakers have a transparent lead-sealable cover that protects access to the adjustment dials.



# Protection of distribution systems

## ComPact NSXm TM thermal-magnetic trip units

### Thermal-magnetic trip units TM16D to 160D

Ratings (A)	In at 40 °C <sup>[1]</sup>	16	25	32	40	50	63	80	100	125	160
Circuit breaker	ComPact NSXm	<input checked="" type="radio"/>	<input checked="" type="radio"/>	<input checked="" type="radio"/>	<input checked="" type="radio"/>	<input checked="" type="radio"/>	<input checked="" type="radio"/>	<input checked="" type="radio"/>	<input checked="" type="radio"/>	<input checked="" type="radio"/>	<input checked="" type="radio"/>
<b>Thermal protection</b>											
Pick-up (A) tripping between 1.05 and 1.20 I <sub>r</sub>	I <sub>r</sub> = I <sub>n</sub> x ...	adjustable in amps from 0.7 to 1 x I <sub>n</sub>									
Time delay (s)	t <sub>r</sub>	non-adjustable									
<b>Magnetic protection</b>											
Pick-up (A)	I <sub>m</sub>	fixed									
accuracy ±20 %	ComPact NSXm	500	600	600	600	600	800	1000	1250	1250	1250
Time delay	t <sub>m</sub>	fixed									
<b>Neutral protection</b>											
Unprotected neutral	4P 3D	no detection									
Fully protected neutral	4P 4D	1 x I <sub>r</sub>									

[1] If the circuit breakers are used in high-temperature environments, the setting must take into account the thermal limitations of the circuit breaker. See the temperature derating table.



# Protection of distribution systems

## ComPact NSX TM thermal-magnetic and MA magnetic trip units

TM thermal-magnetic and MA magnetic trip units can be used on ComPact NSX100/160/250 circuit breakers with performance levels B/F/H/N/S/L. TM trip units are available in 2 versions:

- TM-D, for the protection of distribution cables
- TM-G, with a low threshold, for the protection of generators or long cable lengths.

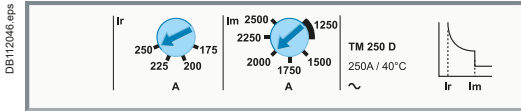

B



ComPact NSX250 F.

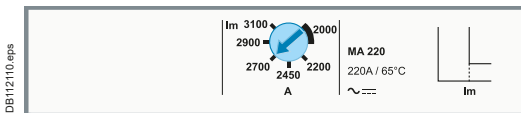

### TM-D and TM-G thermal-magnetic trip units

Circuit breakers equipped with thermal-magnetic trip units are used mainly in industrial and commercial electrical distribution applications:

- TM-D, for protection of cables on distribution systems supplied by transformers
- TM-G, with a low pick-up for generators (lower short-circuit currents than with transformers) and distribution systems with long cable lengths (fault currents limited by the resistance of the cable).

### Protection

#### Thermal protection (Ir)

Thermal overload protection based on a bimetal strip providing an inverse time curve  $I^2t$ , corresponding to a temperature rise limit. Above this limit, the deformation of the strip trips the circuit breaker operating mechanism.

This protection operates according to:

- Ir that can be adjusted in amps from 0.7 to 1 times the rating of the trip unit (16 A to 250 A), corresponding to settings from 11 to 250 A for the range of trip units
- a non-adjustable time delay, defined to ensure protection of the cables.

#### Magnetic protection (Im)

Short-circuit protection with a fixed or adjustable pick-up Im that initiates instantaneous tripping if exceeded.

- TM-D: fixed pick-up, Im, for 16 to 160 A ratings and adjustable from 5 to 10 x In for 200 and 250 A ratings
- fixed pick-up for 16 to 63 A ratings.

#### Protection against insulation faults

Two solutions are possible by adding:

- a Vigi add-on acting directly on the trip unit of the circuit breaker
- a Vigiex relay connected to an MN or MX voltage release.

#### Protection versions

- 3-pole:
  - 3P 3D: 3-pole frame (3P) with detection on all 3 poles (3D)
  - 3P 2D: 3-pole frame (3P) with detection on 2 poles (2D).
- 4-pole:
  - 4P 3D: 4-pole frame (4P) with detection on 3 poles (3D).
  - 4P 4D: 4-pole frame (4P) with detection on all 4 poles (same threshold for phases and neutral).

### MA magnetic trip units

In distribution applications, circuit breakers equipped with MA magnetic-only trip units are used for:

- short-circuit protection of secondary windings of LV/LV transformers with overload protection on the primary side.
- as an alternative to a switch-disconnector at the head of a switchboard in order to provide short-circuit protection.

Their main use is however for motor protection applications, in conjunction with a thermal relay and a contactor or motor starter.

### Protection

#### Magnetic protection (Im)

Short-circuit protection with an adjustable pick-up Im that initiates instantaneous tripping if exceeded.

- $I_m = I_n \times \dots$  set in amps on an adjustment dial covering the range 6 to 14 x In for 2.5 to 100 A ratings or 9 to 14 In for 150 to 220 A ratings.

#### Protection versions

- 3-pole (3P 3D): 3-pole frame (3P) with detection on all 3 poles (3D).
- 4-pole (4P 3D): 4-pole frame (4P) with detection on 3 poles (3D).

**Note:** All the trip units have a transparent lead-sealable cover that protects access to the adjustment dials.

# Protection of distribution systems

## ComPact NSX TM thermal-magnetic and MA magnetic trip units

### Thermal-magnetic trip units TM16D to 250D

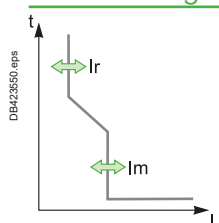

Ratings (A)	In at 40 °C [1]	16	25	32	40	50	63	80	100	125	160	200	250
Circuit breaker	ComPact NSX100	●	●	●	●	●	●	●	●	-	-	-	-
	ComPact NSX160	-	-	●	●	●	●	●	●	●	●	-	-
	ComPact NSX250	-	-	-	-	-	-	●	●	●	●	●	●

Thermal protection		
Pick-up (A) tripping between 1.05 and 1.20 Ir	$I_r = I_n \times \dots$	adjustable in amps from 0.7 to 1 x In
Time delay (s)	<b>tr</b>	non-adjustable
	tr at 1.5 x In	120 to 400
	tr at 6 x Ir	15

Magnetic protection		
Pick-up (A) accuracy ±20 %	<b>Im</b>	fixed
	ComPact NSX100	190 300 400 500 500 500 640 800
	ComPact NSX160/250	190 300 400 500 500 500 640 800 1250 1250 5 to 10xIn
Time delay	<b>tm</b>	fixed

Neutral protection		
Unprotected neutral	4P 3D	no detection
Fully protected neutral	4P 4D	1 x Ir

### Thermal-magnetic trip units TM16G to 250G

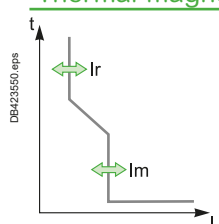

Ratings (A)	In at 40 °C [1]	16	25	40	63	80	100	125	160	200	250
Circuit breaker	ComPact NSX100	●	●	●	●	●	●	-	-	-	-
	ComPact NSX160	-	●	●	●	●	●	●	●	-	-
	ComPact NSX250	-	-	-	-	-	-	-	●	●	●

Thermal protection		
Pick-up (A) tripping between 1.05 and 1.20 Ir	$I_r = I_n \times \dots$	adjustable in amps from 0.7 to 1 x In
Time delay (s)	<b>tr</b>	non-adjustable
	tr at 1.5 x In	120 to 400
	tr at 6 x Ir	-

Magnetic protection		
Pick-up (A) accuracy ±20 %	<b>Im</b>	fixed
	ComPact NSX100	63 80 80 125 200 320 - - - -
	ComPact NSX160	- 80 80 125 200 320 440 440 - -
	ComPact NSX250	- - - - - - - 440 440 520
Time delay	<b>tm</b>	fixed

Neutral protection		
Unprotected neutral	4P 3D	no
Fully protected neutral	4P 4D	1 x Ir

[1] For temperatures greater than 40 °C, the thermal protection characteristics are modified. See the temperature derating table.

### Magnetic trip units MA 2.5 to 220

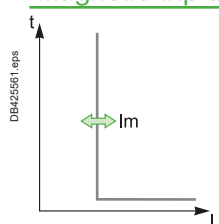

Ratings (A)	In at 65 °C [1]	2.5	6.3	12.5	25	50	100 [1]	150	220
Circuit breaker	ComPact NSX100	●	●	●	●	●	●	-	-
	ComPact NSX160	-	-	-	●	●	●	●	-
	ComPact NSX250	-	-	-	-	-	●	●	●

Instantaneous magnetic protection		
Pick-up (A) accuracy ±20 %	$I_m = I_n \times \dots$	Adjustable from 6 to 14 x In (settings 6, 7, 8, 9, 10, 11, 12, 13, 14)
		Adjustable from 9 to 14 x In (settings 9, 10, 11, 12, 13, 14)
Time delay (ms)	<b>tm</b>	fixed

[1] MA100 3P adjustable from 6 to 14 x In.  
MA100 4P adjustable from 9 to 14 x In.

Note: all the trip units have a transparent lead-sealable cover that protects access to the adjustment dials.



# Protection of distribution systems

## Overview of functions

### Measurement

Energy management is the challenge of present and future generations. To meet this requirement MicroLogic E incorporates all the measuring functions of a power meter.

### Diagnostics & Maintenance

Optimal continuity of services as well as extended life of equipment is one of customer main concerns. For that purpose MicroLogic A and E trip units contributes to corrective, preventive and predictive maintenance.

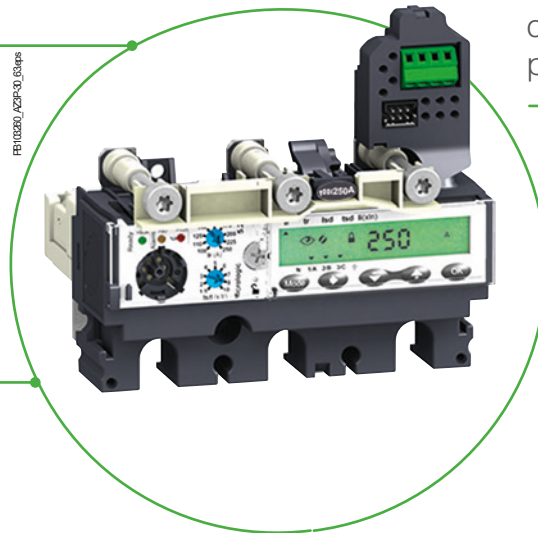

### Protection

MicroLogic 5 (LSI), 6 (LSIG) and 7 (LSIR) offer a large long time delay setting range (0.4 to 1 xIn) and protection accuracy for a wide temperature range (-25 to +70 C).

### Communication

- Protection Control Unit, provides local information for network operation and maintenance, as well as remote information for higher functions of control, monitoring, energy efficiency and assets management.
- To comply with those requirements MicroLogic trip unit and Enerlin'X communication system provides access to status, electrical values and devices control using Ethernet and Modbus SL communication protocols.





B

# Protection of distribution systems

## ComPact NSXm + NSX circuit breakers trip units

B

### Understanding the names of MicroLogic electronic trip units

Example: MicroLogic 6.3 E-M	6	3	E	M
	Protection	Frame	Measurements	Applications
	⋮ ↓	⋮ ↓	⋮ ↓	⋮ ↓
	<p>1: I</p> <p>2: LS<sub>0</sub>I</p> <p>4: LS<sub>0</sub>IR</p> <p>5: LSI</p> <p>6: LSIG</p> <p>I: Instantaneous</p> <p>L: Long time</p> <p>R: Residual current</p> <p>S<sub>0</sub>: Short time <sup>[2]</sup> (fixed delay)</p> <p>S: Short time</p> <p>G: Ground fault</p>	<p>1: NSXm 16 to 160</p>  <p>2: NSX 100/160/250</p>  <p>3: NSX 400/630</p> 	<p>A: Ammeter</p>  <p>E: Energy</p> 	<p>Distribution, otherwise</p> <p>G: Generator</p> <p>AB: Public distribution <sup>[1]</sup></p> <p>M: Motors</p> <p>Z: 16 Hz 2/3 <sup>[1]</sup></p>
	⋮ ↓	⋮ ↓	⋮ ↓	⋮ ↓

Examples				
MicroLogic 1.3	Instantaneous only	400 or 630 A	-	Distribution
MicroLogic 2.3	LS <sub>0</sub> I	400 or 630 A	-	Distribution
MicroLogic Vigi 4.1	LS <sub>0</sub> IR	16 to 160 A	-	Distribution
MicroLogic 5.2 A	LSI	100, 160 or 250 A	Ammeter	Distribution
MicroLogic 6.3 E-M	LSIG	400 or 630 A	Energy	Motor

[1] AB-Z: except NSXm and NSX R, HB1, HB2.

[2] LS<sub>0</sub>I protection is standard on MicroLogic 2. To ensure selectivity, it offers short-time protection S<sub>0</sub> with a non-adjustable delay and instantaneous protection.

# Protection of distribution systems

## ComPact NSX MicroLogic 2 and 1.3 trip units

MicroLogic 2 trip units can be used on ComPact NSX100 to 630 circuit breakers with performance levels B/F/H/N/S/L/R/HB1/HB2.

They provide:

- standard protection of distribution cables
- indication of:
  - overloads (via LEDs)
  - overload tripping (via the SDx relay module).

B

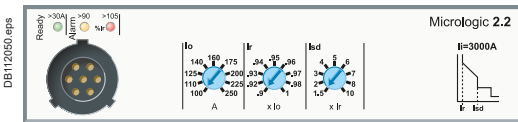

SDx remote indication relay module with its terminal block.

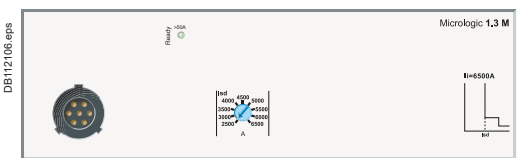

### MicroLogic 2

Circuit breakers equipped with MicroLogic 2 trip units can be used to protect distribution systems supplied by transformers. For generators and long cables, MicroLogic 2 G trip units offer better suited low pick-up solutions (see page B-50).

### Protection

Settings are made using the adjustment dials with fine adjustment possibilities.

#### Overloads: Long time protection (Ir)

Inverse time protection against overloads with an adjustable current pick-up Ir set using a dial and a non-adjustable time delay tr.

#### Short-circuits: Short-time protection with fixed time delay (Isd)

Protection with an adjustable pick-up Isd. Tripping takes place after a very short delay used to allow selectivity with the downstream device.

#### Short-circuits: Non-adjustable instantaneous protection

Instantaneous short-circuit protection with a fixed pick-up.

#### Neutral protection

- On 3-pole circuit breakers, neutral protection is not possible.
- On four-pole circuit breakers, neutral protection may be set using a three-position switch:
  - 4P 3D: neutral unprotected
  - 4P 3D + N/2: neutral protection at half the value of the phase pick-up, i.e. 0.5 x Ir
  - 4P 4D: neutral fully protected at Ir.



### Indications

#### Front indications

- Green "Ready" LED: flashes slowly when the circuit breaker is ready to trip in the event of a fault.
- Orange overload pre-alarm LED: steady on when  $I > 90\% I_r$ .
- Red overload LED: steady on when  $I > 105\% I_r$ .

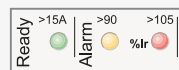

#### Remote indications

An overload trip signal can be remotely by installing an SDx relay module inside the circuit breaker.

This module receives the signal from the MicroLogic electronic trip unit via an optical link and makes it available on the terminal block. The signal is cleared when the circuit breaker is reclosed. For description, see page C-28.

### MicroLogic 1.3 M for magnetic protection only

MicroLogic 1.3 M trip units provide magnetic protection only, using electronic technology. They are dedicated to 400/630 A 3-poles (3P 3D) circuit breakers or 4-pole circuit breakers with detection on 3 poles (4P, 3D) and are used in certain applications to replace switch-disconnectors at the head of switchboards. They are especially used in 3-poles versions for motor protection, see page B-30.

**Note:** all the trip units have a transparent lead-sealable cover that protects access to the adjustment dials.

# Protection of distribution systems

## ComPact NSX MicroLogic 2 and 1.3 trip units

B

### MicroLogic 2

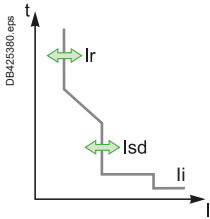

Ratings (A)	In at 40 °C [1]	40	100	160	250	400	630
Circuit breaker	ComPact NSX100	●	●	-	-	-	-
	ComPact NSX160	●	●	●	-	-	-
	ComPact NSX250	●	●	●	●	-	-
	ComPact NSX400	-	-	-	●	●	-
	ComPact NSX630	-	-	-	●	●	●

#### L Long-time protection

Pick-up (A) tripping between 1.05 and 1.20 Ir	lo	value depending on trip unit rating (In) and setting on dial								
In = 40 A	lo =	18	18	20	23	25	28	32	36	40
In = 100 A	lo =	40	45	50	55	63	70	80	90	100
In = 160 A	lo =	63	70	80	90	100	110	125	150	160
In = 250 A (NSX250)	lo =	100	110	125	140	160	175	200	225	250
In = 250 A (NSX400)	lo =	70	100	125	140	160	175	200	225	250
In = 400 A	lo =	160	180	200	230	250	280	320	360	400
In = 630 A	lo =	250	280	320	350	400	450	500	570	630
Ir = lo x ...		9 fine adjustment settings from 0.9 to 1 (0.9 - 0.92 - 0.93 - 0.94 - 0.95 - 0.96 - 0.97 - 0.98 - 1) for each value of lo								

Time delay (s) accuracy 0 to -20%	tr	non-adjustable
	1.5 x Ir	400
	6 x Ir	16
	7.2 x Ir	11

Thermal memory 20 minutes before and after tripping

#### S<sub>n</sub> Short-time protection with fixed time delay

Pick-up (A) accuracy ±10 %	Isd = Ir x ...	1.5	2	3	4	5	6	7	8	10
Time delay (ms)	tsd	non-adjustable								
	Non-tripping time	20								
	Maximum break time	80								

#### I Instantaneous protection

Pick-up (A) accuracy ±15 %	Ii non-adjustable	600	1500	2400	3000	4800	6900
	Non-tripping time	10 ms					
	Maximum break time	50 ms					

[1] If the trip units are used in high-temperature environments, the MicroLogic setting must take into account the thermal limitations of the circuit breaker. See the temperature derating table.

### MicroLogic 1.3 M

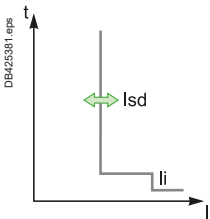

Ratings (A)	In at 65 °C [1]	320	500
Circuit breaker	ComPact NSX400	●	-
	ComPact NSX630	●	●

#### S Short-time protection

Pick-up (A) accuracy ±15 %	Isd	Adjustable directly in amps	
		9 settings: 1600, 1920, 2240, 2560, 2880, 3200, 3520, 3840, 4160 A	9 settings: 2500, 3000, 3500, 4000, 4500, 5000, 5500, 6000, 6500 A
Time delay (ms)	tsd	Non-adjustable	
	Non-tripping time	10	
	Maximum break time	60	

#### I Instantaneous protection

Pick-up (A) accuracy ±15 %	Ii non-adjustable	4800	6500
	Non-tripping time	0	
	Maximum break time	30 ms	

[1] Motor standards require operation at 65 °C. Circuit-breaker ratings are derated to take this requirement into account.

# Protection of distribution systems

## ComPact NSX MicroLogic 5 / 6 A or E trip units

MicroLogic 5 / 6 A (Ammeter) or E (Energy) trip units can be used on ComPact NSX100 to 630 circuit breakers with performance levels B/F/H/N/S/L/R/HB1/HB2. They all have a display unit. They offer basic LSI protection (MicroLogic 5) or LSI and ground-fault protection G (MicroLogic 6). They also offer measurement, alarm and communication functions.

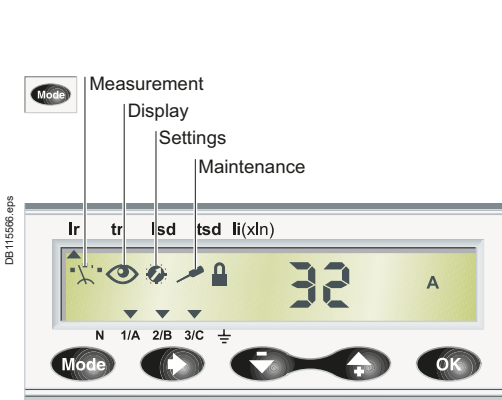
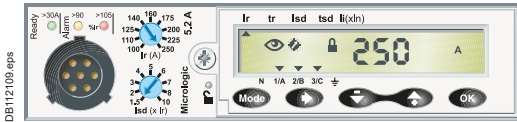

Trip unit menus.

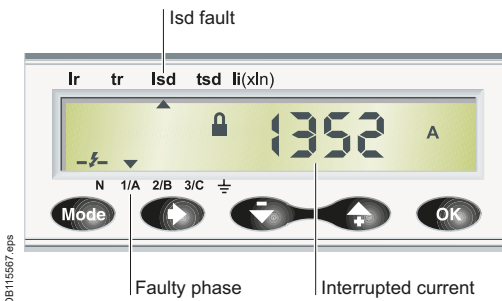

Display of interrupted current.

### Protection

Settings can be adjusted in two ways, using the dials and/or the keypad. The keypad can be used to make fine adjustments in 1 A steps below the maximum value defined by the setting on the dial. Access to setting modifications via the keypad is protected by a locking function displayed on the screen and controlled by a microswitch. The lock is activated automatically if the keypad is not used for 5 minutes. Access to the microswitch is protected by a transparent lead-sealable cover. With the cover closed, it is still possible to display the various settings and measurements using the keypad.

#### Overloads: Long time protection (Ir)

Inverse time protection against overloads with an adjustable current pick-up **Ir** set using a dial or the keypad for fine adjustments. The time delay **tr** is set using the keypad.

#### Short-circuits: Short-time protection (I<sub>sd</sub>)

Short-circuit protection with an adjustable pick-up **I<sub>sd</sub>** and adjustable time delay **tsd**, with the possibility of including a portion of an inverse time curve (I<sup>2</sup>t On).

#### Short-circuits: Instantaneous protection (I<sub>i</sub>)

Instantaneous protection with adjustable pick-up **I<sub>i</sub>**.

#### Additional ground fault protection (I<sub>g</sub>) on MicroLogic 6

Residual type ground-fault protection with an adjustable pick-up **I<sub>g</sub>** (with Off position) and adjustable time delay **tg**. Possibility of including a portion of an inverse time curve (I<sup>2</sup>t On).

#### Neutral protection

On 4-pole circuit breakers, this protection can be set via the keypad:

- Off: neutral unprotected
- 0.5: neutral protection at half the value of the phase pick-up, i.e. 0.5 x Ir
- 1.0: neutral fully protected at Ir
- OSN: Oversized neutral protection at 1.6 times the value of the phase pick-up.

Used when there is a high level of 3rd order harmonics (or orders that are multiples of 3) that accumulate in the neutral and create a high current. In this case, the device must be limited to  $I_r = 0.63 \times I_n$  for the maximum neutral protection setting of 1.6 x Ir.

With 3-pole circuit breakers, the neutral can be protected by installing an external neutral sensor with the output (T1, T2) connected to the trip unit.

#### Zone selective interlocking (ZSI)

A ZSI terminal block may be used to interconnect a number of MicroLogic control units to provide zone selective interlocking for short-time (I<sub>sd</sub>) and ground-fault (I<sub>g</sub>) protection, without a time delay. For ComPact NSX 100 to 250, the ZSI function is available only in relation to the upstream circuit breaker (ZSI out).

### Display of type of fault

On a fault trip, the type of fault (Ir, I<sub>sd</sub>, I<sub>i</sub>, I<sub>g</sub>), the phase concerned and the interrupted current are displayed. An external power supply is required.

### Indications

#### Front indications



- Green "Ready" LED: flashes slowly when the circuit breaker is ready to trip in the event of a fault.
- Orange overload pre-alarm LED: steady on when  $I > 90 \% I_r$ .
- Red overload LED: steady on when  $I > 105 \% I_r$ .

#### Remote indications

An SDx relay module installed inside the circuit breaker can be used to remotely access to the following information:

- overload trip
- overload prealarm (MicroLogic 5) or ground fault trip (MicroLogic 6).

This module receives the signal from the MicroLogic electronic trip unit via an optical link and makes it available on the terminal block. The signal is cleared when the circuit breaker is closed.

These outputs can be reprogrammed to be assigned to other types of tripping or alarm. The module is described in detail in the section dealing with accessories.

**Note:** all the trip units have a transparent lead-sealable cover that protects access to the adjustment dials.



# Protection of distribution systems

## ComPact NSX MicroLogic 5 / 6 A or E trip units

### Protection MicroLogic 5 / 6 A or E trip units

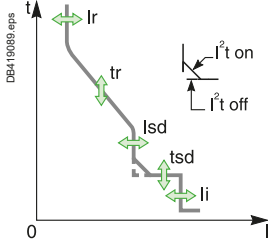

Ratings (A)	In at 40 °C [1]	40 [2]	100	160	250	400	630
Circuit breaker	ComPact NSX100	●	●	-	-	-	-
	ComPact NSX160	●	●	●	-	-	-
	ComPact NSX250	●	●	●	●	-	-
	ComPact NSX400	-	-	-	-	●	-
	ComPact NSX630	-	-	-	-	●	●

#### L Long-time protection

Pick-up (A) tripping between 1.05 and 1.20 Ir	Ir = ...	dial setting	value depending on trip unit rating (In) and setting on dial									
	In = 40 A	Io =	18	18	20	23	25	28	32	36	40	
	In = 100 A	Io =	40	45	50	55	63	70	80	90	100	
	In = 160 A	Io =	63	70	80	90	100	110	125	150	160	
	In = 250 A	Io =	100	110	125	140	160	175	200	225	250	
	In = 400 A	Io =	160	180	200	230	250	280	320	360	400	
	In = 630 A	Io =	250	280	320	350	400	450	500	570	630	
		keypad setting	Fine adjustment in 1 A steps below maximum value set on dial									
Time delay (s) accuracy 0 to -20 %	tr = ...	keypad setting	0.5	1	2	4	8	16				
		1.5 x Ir	15	25	50	100	200	400				
		6 x Ir	0.5	1	2	4	8	16				
		7.2 x Ir	0.35	0.7	1.4	2.8	5.5	11				
Thermal memory			20 minutes before and after tripping									

#### S Short-time protection with adjustable time delay

Pick-up (A) accuracy ±10 %	Isd = Ir x ...	dial setting for MicroLogic 5	1.5	2	3	4	5	6	7	8	10
		keypad settings for MicroLogic 6	Adjustment in steps of 0.5 x Ir over the range 1.5 x Ir to 10 x Ir								
Time delay (s)	tsd = ...	keypad setting	0	0.1	0.2	0.3	0.4				
		I²Off setting	-	0.1	0.2	0.3	0.4				
		I²On	-	0.1	0.2	0.3	0.4				
	Non-tripping time (ms)		20	80	140	230	350				
	Maximum break time (ms)		80	140	200	320	500				

#### I Instantaneous protection

Pick-up (A) accuracy ±15 %	li = In x	keypad setting	Adjustment in steps of 0.5 x In over the range 1.5 x In to: 15 x In (40 to 160 A), 12 x In (250 to 400 A) or 11 x In (630 A)								
	Non-tripping time		10 ms								
	Maximum break time		50 ms								

#### G Ground-fault protection - for MicroLogic 6 A or E

Pick-up (A) accuracy ±10 %	Ig = In x	dial setting										
	In = 40 A		0.4	0.4	0.5	0.6	0.7	0.8	0.9	1	Off	
	In > 40 A		0.2	0.3	0.4	0.5	0.6	0.7	0.8	1	Off	
			Fine adjustment in 0.05 A steps using the keypad									
Time delay (s)	tg = ...	keypad setting	0	0.1	0.2	0.3	0.4					
		I²Off setting	-	0.1	0.2	0.3	0.4					
		I²On	-	0.1	0.2	0.3	0.4					
	Non-tripping time (ms)		20	80	140	230	350					
	Maximum break time (ms)		80	140	200	320	500					
Test	Ig function		built-in									

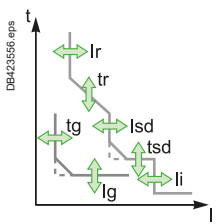

[1] If the trip units are used in high-temperature environments, the MicroLogic setting must take into account the thermal limitations of the circuit breaker. See the temperature derating table.

[2] For 40 A rating, the neutral N/2 adjustment is not possible.



## Select your protection

# Protection of distribution systems

## ComPact NSXm MicroLogic Vigi 4.1 trip unit with integrated earth leakage protection

ComPact NSXm circuit breakers up to 160 A can be ordered with MicroLogic Vigi 4.1 trip unit with performance levels E/B/F/N/H.

They provide:

- standard protection of distribution cables
- earth leakage protection
- indication of:
  - overload alarming (via LEDs and via SDx module)
  - overload tripping (via the SDx module)
  - earth leakage alarming (via the SDx module)
  - earth leakage tripping (via front face screen and the SDx module).

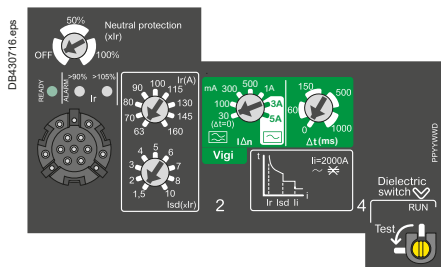

ComPact NSXm MicroLogic Vigi 4.1.

### MicroLogic Vigi 4.1

Circuit breakers equipped with MicroLogic Vigi 4.1 trip units can be used to protect distribution systems supplied by transformers.

### Short-circuit and overload protection

Settings are made using the adjustment dials.

#### Overloads: Long time protection ( $I_r$ )

Inverse time protection against overloads with a wide range adjustable current pick-up  $I_r$  set using a dial and a non-adjustable time delay  $t_r$ .

#### Short-circuits: Short-time protection with fixed time delay ( $I_{sd}$ )

Protection with an adjustable pick-up  $I_{sd}$ . Tripping takes place after a very short delay used to allow selectivity with the downstream device.

#### Short-circuits: Non-adjustable instantaneous protection

Instantaneous short-circuit protection with a fixed pick-up.

#### Neutral protection

- On 3-pole circuit breakers, neutral protection is not possible.
- On 4-pole circuit breakers, neutral protection may be set using a three-position switch:
  - OFF: neutral unprotected
  - 50 % <sup>[1]</sup>: neutral protection at half the value of the phase pick-up, i.e.  $0.5 \times I_r$
  - 100 %: neutral fully protected at  $I_r$ .

### Earth leakage protection

Protection with an adjustable leakage level ( $I_{\Delta n}$ ) with an adjustable delay ( $\Delta t$ ).

#### Compliance with standards

- IEC 60947-2, annex B.
- IEC 60755, class A, immunity to DC components up to 6 mA.
- Operation down to  $-25^\circ\text{C}$  as per VDE 664.

#### Power supply

It is self-powered internally and therefore does not require any external source. It's still working even when supplied by only two phases.

#### Sensitivity $I_{\Delta n}$ (A)

- Type A: 30mA - 100mA - 300mA - 500mA - 1A.
- Type AC: 30mA - 100mA - 300mA - 1A - 3A - 5A.

#### Intentional delay $\Delta t$ (ms)

0 - 60 <sup>[2]</sup> - 150 <sup>[2]</sup> - 500 <sup>[2]</sup> - 1000 <sup>[2]</sup>.

#### Operated voltage

200...440 V AC - 50/60 Hz.

#### Operating safety

The earth leakage protection is a user safety device. It must be tested at regular intervals (every 6 months) via test button.

[1] On 100A and 160A circuit breakers only.

[2] If the sensitivity is set to 30 mA, there is no time delay, whatever the time-delay setting.

**Note:** all the trip units have a transparent lead-sealable cover that protects access to the adjustment dials.

# Protection of distribution systems

## ComPact NSXm MicroLogic Vigi 4.1 trip unit with integrated earth leakage protection

### Indications

#### Front indications

- Green "Ready" LED: flashes slowly when the circuit breaker is ready to trip in the event of an overload or short-circuit fault.
- Orange overload pre-alarm LED: steady on when  $I > 90\% I_r$ .
- Red overload LED: steady on when  $I > 105\% I_r$ .
- Screen that indicate an earth leakage fault trip - reset when product is powered.

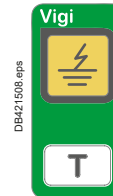

#### Alarming and fault differentiation

A side module SDx can be installed to provide alarming and fault differentiation:

- overload alarm ( $I > 105\% I_r$ )
- overload trip indication
- earth leakage alarm ( $I_{\Delta n} > 80\%$  threshold)
- earth leakage trip indication.

This module receives the signal from the MicroLogic electronic trip unit via an optical link and makes it available on the terminal block through NO/NC dry contacts.

The signal is cleared when the circuit breaker is restarted.

For description, see page C-11.



### MicroLogic Vigi 4.1

	Ratings (A)	In at 40 °C [1]	25	50	100	160					
	Circuit breaker	ComPact NSXm	<input checked="" type="radio"/>	<input checked="" type="radio"/>	<input checked="" type="radio"/>	<input checked="" type="radio"/>					
<b>L Long-time protection</b>											
	Pick-up (A)	$I_r$	value depending on trip unit rating ( $I_n$ ) and setting on dial								
	tripping between 1.05 and 1.20 $I_r$	$I_n = 25\text{ A}$	$I_r = 10$	11	12	14	16	18	20	22	25
		$I_n = 50\text{ A}$	$I_r = 20$	22	25	28	32	36	40	45	50
		$I_n = 100\text{ A}$	$I_r = 40$	45	50	56	63	70	80	90	100
		$I_n = 160\text{ A}$	$I_r = 63$	70	80	90	100	115	130	145	160
	Time delay (s)	<b>tr</b>	non-adjustable								
	accuracy 0 to -20%		1.5 x $I_r$	200							
			6 x $I_r$	8							
			7.2 x $I_r$	5							
	Thermal memory	20 minutes before and after tripping									
<b>S<sub>0</sub> Short-time protection with fixed time delay</b>											
	Pick-up (A)	<b>Isd = <math>I_r \times \dots</math></b>	1.5	2	3	4	5	6	7	8	10
	accuracy $\pm 15\%$										
	Time delay (ms)	<b>tsd</b>	non-adjustable								
		Non-tripping time	20								
		Maximum break time	80								
<b>I Instantaneous protection</b>											
	Pick-up (A)	<b>li</b> non-adjustable	375	750	1500	2000					
	accuracy $\pm 15\%$	Non-tripping time	10 ms			5 ms					
		Maximum break time	50 ms								
<b>R Earth leakage protection</b>											
	Sensitivity $I_{\Delta n}$ (A)	Adjustable	$I_{\Delta n} =$	0.03	0.1	0.3	0.5	1	3	5	
		Type	A and AC							AC	
	Time delay $\Delta t$ (ms)	Adjustable	$\Delta t =$	0	60 [2]	150 [2]	500 [2]	1000 [2]			
		Maximum break time (ms)	< 40	< 140	< 300	< 800	< 1500				

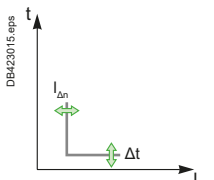
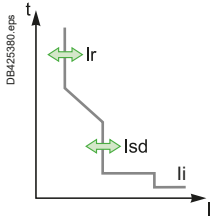

[1] If the circuit breakers are used in high-temperature environments, the setting must take into account the thermal limitations of the circuit breaker.  
 [2] If the sensitivity is set to 30 mA, there is no time delay, whatever the time-delay setting.

# Protection of distribution systems

## ComPact NSX MicroLogic Vigi 4 trip unit with integrated earth leakage protection

The ComPact NSX range is now complemented with a new type of MicroLogic trip unit including both circuit protection and earth leakage protection. It means that the earth leakage protection, previously located within the Vigi Add-on, will be integrated within the existing size of the MicroLogic trip unit. MicroLogic Vigi 4 is compliant with IEC 60947-2 annex B.

B

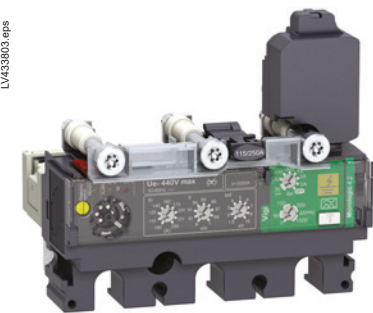

MicroLogic Vigi 4 (LS<sub>0</sub>IR).

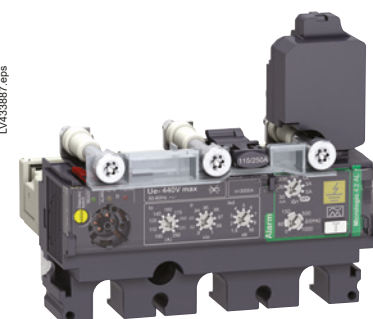

MicroLogic Vigi 4 AL (LS<sub>0</sub>I + Earth Leakage Alarm).

### MicroLogic Vigi 4

There are two versions of MicroLogic Vigi 4:

- distribution protection including Earth Leakage Protection (LS<sub>0</sub>IR)
- distribution protection including Earth Leakage Alarm (LS<sub>0</sub>I + Earth Leakage Alarm).

### Protections

Settings are made using the rotary dial with fine adjustment capabilities.

### Short circuit and overload protections

#### Overload: long-time protection (I<sub>r</sub>)

Inverse time protection against overload with an adjustable current pick-up I<sub>r</sub> set using a dial and a non-adjustable time delay t<sub>r</sub>.

#### Short-circuit: short-time protection with fixed time delay (I<sub>sd</sub>)

That protection is set with an adjustable pick-up I<sub>sd</sub>. The tripping takes place after a very short time used to allow selectivity with downstream devices.

#### Short circuit: non-adjustable instantaneous protection (with a fix pick-up)

#### Neutral protection

- On a 3-pole device, neutral protection is not possible
- On a 4-pole device, neutral protection may be set using the dedicated coding wheel to meet the following configurations: 4P 3D, 4P 3D + N/2 or 4P 4D (same as for MicroLogic 2).

### Earth leakage protections

Adjustable leakage threshold (I<sub>Δn</sub>) and adjustable time delay threshold (Dt) by using the two dials on the green area of the trip unit.

#### Power supply

The trip unit is self supplied, and so does not need any external source. It works even when fed by 2 phases only.

#### Sensitivity I<sub>Δn</sub> (A)

- Type A: 30mA - 100mA - 300mA - 500mA - 1A - 3A - 5A (for the ratings 40 to 250A)
- Type A: 300mA - 500mA - 1A - 3A - 5A - 10A (for the ratings 400 to 570A).

**Caution:** "OFF" setting of I<sub>Δn</sub> is possible. It cancels the earth leakage protection, in that case, the circuit breaker with MicroLogic Vigi 4 behaves as a standard circuit breaker. That "OFF" position is located on the highest side of the coding wheel.

#### Intentional delay I<sub>Δt</sub> (s)

- Case I<sub>Δn</sub> = 30mA: Δt 0 sec (whatever the setting)
- Case I<sub>Δn</sub> > 30mA: Δt 0 – 60ms – 150ms – 500ms – 1sec (by setting)

#### Operated voltage

200 to 440 VAC (only) – 50/60 Hz

#### Operating safety

The earth leakage protection is a user safety device. It must be regularly tested using the test button (T) that simulates a real current leakage within the toroid. When I<sub>Δn</sub> is set on the OFF position, press the T will cancel any test.

As for standard circuit breaker, the circuit breaker with MicroLogic Vigi 4 can be reset after any fault by operating an OFF/ON procedure.

Specific for the circuit breaker with MicroLogic Vigi 4 Alarm (AL), after testing as well as after a real leakage fault, it can be reset by pressing more than 3 seconds the test button (T), to avoid switching OFF the device.

# Protection of distribution systems

## ComPact NSX MicroLogic Vigi 4 trip unit with integrated earth leakage protection

### Indications

#### Front indications

- Green "Ready" LED: flashes slowly when the circuit breaker is ready to trip in case of a fault.
- Orange overload pre-alarm LED: steady ON when  $I > 90\% I_r$ .
- Red overload LED: steady ON when  $I > 105\% I_r$ .
- Yellow Screen: indicates an earth leakage fault (reset when operating OFF/ON for the "trip" or when pressing >3sec the T button for the Alarm).

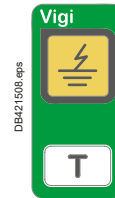

#### Alarming and fault differentiation

- An overload trip signal can be remotely available by installing an SDx relay module inside the circuit breaker on both "trip" and "alarm" versions.
- An earth leakage trip signal can be remotely available by installing an SDx module, only on the "trip" version.
- An earth leakage alarm signal (MicroLogic Vigi 4 AL) can be remotely available on the SDx, for the circuit breaker with MicroLogic Vigi 4 Alarm". This module receives the signal from the MicroLogic trip unit via an optical link and makes it available on the terminal block. The signal is reset when the breaker is operated.

### MicroLogic Vigi 4

	Ratings (A)	In at 40 °C [1]	40	100	160	250	400	570		
	Circuit breaker	ComPact NSX100	●	●						
		ComPact NSX160	●	●	●					
		ComPact NSX250	●	●	●	●				
		ComPact NSX400					●			
		ComPact NSX630					●	●		
<b>L Long-time protection</b>										
Pick-up (A) tripping between 1.05 and 1.20 Ir	In = 40 A	lo = 18	18	20	23	25	28	32	36	40
	In = 100 A	lo = 40	45	50	55	63	70	80	90	100
	In = 160 A	lo = 63	70	80	90	100	110	125	150	160
	In = 250 A	lo = 100	110	125	140	160	175	200	225	250
	In = 400 A	lo = 160	180	200	230	250	280	320	360	400
	In = 570 A	lo = 250	280	320	350	400	450	500	570	570
	Ir = lo x	9 fine adjustment settings from 0.9 to 1 (0.9 – 0.92 ... 0.98 - 1)								
Time delay (s) accuracy 0 to -20%	tr	non-adjustable								
	at	1.5 x Ir	tr = 400 s							
	at	6 x Ir	tr = 16 s							
	at	7.2 x Ir	tr = 11 s							
Thermal memory	20 minutes before and after tripping									
<b>S<sub>0</sub> Short-time protection with fixed time delay</b>										
Pick-up (A) accuracy ±10%	Isd = Ir x ...	1.5	2	3	4	5	6	7	8	10
Time delay (ms)	tsd	non-adjustable								
	Non-tripping time	20								
	Maximum break time	80								
<b>I Instantaneous protection</b>										
Pick-up (A) accuracy ±15%	li non-adjustable	600	1500	2400	3000	4800	6900			
	Non-tripping time	10 ms								
	Maximum break time	50 ms								
<b>R Earth leakage protection / Earth leakage alarm</b>										
Sensitivity (A)	Type A, adjustable (9 positions)									
	In = 40 A	lΔn = 0.03	0.03	0.1	0.3	0.5	1	3	5	OFF
	In = 100 A	lΔn = 0.03	0.03	0.1	0.3	0.5	1	3	5	OFF
	In = 160 A	lΔn = 0.03	0.03	0.1	0.3	0.5	1	3	5	OFF
	In = 250 A	lΔn = 0.03	0.03	0.1	0.3	0.5	1	3	5	OFF
	In = 400 A	lΔn = 0.3	0.3	0.5	1	3	5	10	10	OFF
	In = 570 A	lΔn = 0.3	0.3	0.5	1	3	5	10	10	OFF
Time delay Δt (ms)	Adjustable	Δt = 0	60 [2]	150 [2]	500 [2]	1000 [2]				
	Maximum break time (ms)	<40	<140	<300	<800	<1500	ms			

[1] For the use in high temperature environment, take into account the thermal limitation of the breaker.

[2] The time delay (Δt) is mandatory and forced to "Δt = 0" when the lΔn dial is set on 30mA (0.03). The time delay has no effect when the dial lΔn is set to the "OFF" position.



# Protection of distribution systems

## ComPact NSX MicroLogic Vigi 7 E trip unit with integrated earth leakage protection

The ComPact NSX range is now complemented with a new type of MicroLogic trip unit including circuit protection, metering and earth leakage protection. It means that the earth leakage protection, previously located within the Vigi Add-on, will be integrated within the existing size of the MicroLogic trip unit. MicroLogic Vigi 7 E is compliant with IEC 60947-2 annex B.

B

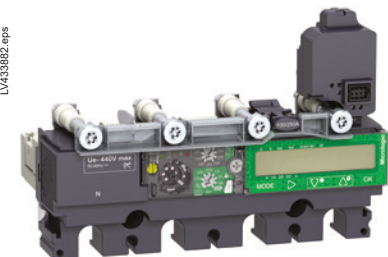

MicroLogic Vigi 7 E (LSIR).

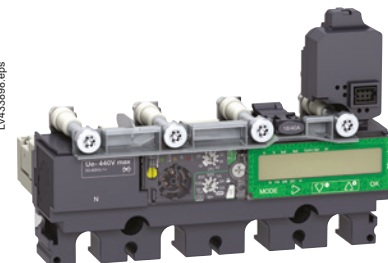

MicroLogic Vigi 7 E AL (LSI + Earth Leakage Alarm).

### MicroLogic Vigi 7 E

There are two versions of MicroLogic Vigi 7 E:

- distribution protection including Earth Leakage Protection (LSIR)
- distribution protection including Earth Leakage Alarm (LSI + Earth Leakage Alarm).

### Locking Protection - Parameter Settings

Settings are made using the rotary dial or/and the keypad. The protection parameter settings are locked when the transparent cover is closed and sealed to prevent access to the adjustment dials and the locking/unlocking microswitch. But you can display the various parameters using the keypad even when the cover is closed (and sealed).

### Short circuit and overload protections

#### Overload: long time protection ( $I_r$ )

Inverse time protection against overload with an adjustable current pick-up  $I_r$  set using the dial or the keypad for fine adjustments. The adjustable time delay  $t_r$  is set using the keypad only.

#### Short-circuit: short circuit protection ( $I_{sd}$ )

That protection is with an adjustable pick-up  $I_{sd}$  and an adjustable time delay  $t_{sd}$ . It is possible to include a portion of an inverse time curve ( $I^2 t$  On).

#### Short circuit: Instantaneous protection ( $I_i$ )

Instantaneous protection with an adjustable protection pick-up  $I_i$ .

#### Neutral protection

- On a 4-pole device, the neutral protection may be set using the dedicated coding wheel to meet the following configurations: 4P 3D, 4P 3D + N/2 or 4P 4D (same as for MicroLogic 5)
- OSN (oversized neutral protection) at 1.6 times the phase pick-up value; useful where there is a high level of 3rd order harmonics (or multiple of 3) that create an over-current within the neutral. In that case the device has to be limited to  $I_r = I_n \times 0.63$  (for each phase) to allow the neutral protection setting to 1.6 x  $I_r$ .

### Earth leakage protections

Adjustable leakage threshold ( $I_{\Delta n}$ ) using the dial only (without any use of the keypad for fine-tuning) and an adjustable time delay threshold ( $\Delta t$ ) using the keypad only.

#### Power supply

The MicroLogic trip unit is powered with its own current in order to guarantee the protection functions.

If there is no optional external 24 VDC power supply, the MicroLogic trip unit only works when the circuit breaker is closed. When the circuit breaker is open or the through current is low (15 to 50 A depending on the rating), the MicroLogic trip unit is no longer powered and its display switches off.

An external 24 VDC power supply for the MicroLogic trip unit is optional for:

- modifying the setting values when the circuit breaker is open
- displaying measurements when there is a low current through the circuit breaker (15 to 50 A depending on the rating) when the circuit breaker is closed
- continuing to display the reason for the trip and the breaking current when the circuit breaker is open.

#### Sensitivity $I_{\Delta n}$ (A)

- Type A: 30mA - 100mA - 300mA - 500mA - 1A - 3A - 5A (for the ratings 40 to 250A)
- Type A: 300mA - 500mA - 1A - 3A - 5A - 10A (for the ratings 400 to 570A)

**Caution:** "OFF" setting of  $I_{\Delta n}$  is possible, it cancels the earth leakage protection, in that case, the circuit breaker with MicroLogic Vigi 4 behaves as a standard circuit breaker. "OFF" position is located on the highest side of the coding wheel.

# Protection of distribution systems

## ComPact NSX MicroLogic Vigi 7 E trip unit with integrated earth leakage protection

### Intentional delay $I\Delta t$ (s)

- Case  $I\Delta n = 30\text{mA}$ :  $\Delta t 0 \text{ sec}$
- Case  $I\Delta n > 30\text{mA}$ :  $\Delta t 0 - 60\text{ms} - 150\text{ms} - 500\text{ms} - 1\text{sec}$

### Operated voltage

200 to 440 VAC (only) – 50/60 Hz

### Operating safety

The earth leakage protection is a user safety device. It must be regularly tested using the test button (T) that simulates a real current leakage within the toroid. When  $I\Delta n$  is set on the OFF position, press the T will cancel any test. As for the standard circuit breaker, the circuit breaker with MicroLogic Vigi 7 E ("Trip" or "Alarm" version) can be reset after any fault by using the keypad.

The MicroLogic Vigi 7 E allows you to set-up a specific "(T) test without tripping" procedure using the keypad.

### Display of the type of fault

On a trip, the root cause of the fault (phase and interrupted current) are displayed. An external power supply is needed to ensure this function.

# Protection of distribution systems

## ComPact NSX MicroLogic Vigi 7 E trip unit with integrated earth leakage protection



DB-421208 eps

B

### Indications

#### Front indication

- Green "Ready" LED: flashes slowly when the circuit breaker is ready to trip in case of a fault.
- Orange overload pre-alarm LED: steady ON when  $I > 90\% I_r$ .
- Red overload LED: steady ON when  $I > 105\% I_r$ .

Written on keypad: earth leakage fault indication (reset using the keypad) for both "Trip" & "Alarm".

#### Alarming and fault differentiation

An SDx relay module can be installed inside the earth leakage circuit breaker to remotely access to the following data:

- Overload pre-Alarm
- Overload trip
- Earth leakage pre-alarm (useful for the "trip" version of the circuit breaker with MicroLogic Vigi 7 E only)
- Earth leakage trip (exist for the "trip" version of the circuit breaker with MicroLogic Vigi 7 E only)
- Earth leakage Alarm without "trip" (circuit breaker with MicroLogic Vigi 7 E AL version only).

This module receives the signal from the MicroLogic electronic trip unit via an optical link and makes it available on the terminal block. The signal is reset when the breaker is operated.

These outputs can be reprogrammed to be assigned to other types of tripping or alarm. The module is deeper described in the section dealing with accessories.



# Protection of distribution systems

## ComPact NSX MicroLogic Vigi 7 E trip unit with integrated earth leakage protection

### MicroLogic Vigi 7 E

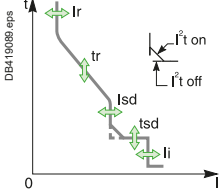

Ratings (A)	In at 40 °C [1]	40 [2]	100	160	250	400	570
Circuit breaker	ComPact NSX100	●	●				
	ComPact NSX160	●	●	●			
	ComPact NSX250	●	●	●	●		
	ComPact NSX400					●	
	ComPact NSX630					●	●

### L Long-time protection

Pick-up (A)	Dial setting	value depending on the rating (In) and the dial setting									
tripping between 1.05 and 1.20 Ir	<b>Ir</b>	In = 40 A	lo = 18	18	20	23	25	28	32	36	40
	In = 100 A	lo = 40	45	50	55	63	70	80	90	100	
	In = 160 A	lo = 63	70	80	90	100	110	125	150	160	
	In = 250 A	lo = 100	110	125	140	160	175	200	225	250	
	In = 400 A	lo = 160	180	200	230	250	280	320	360	400	
	In = 570 A	lo = 250	280	320	350	400	450	500	570	570	
Time delay (s) accuracy 0 to -20%	Keypad setting	fine adjustment in 1A step below the max value set on the dial									
	<b>tr</b>	Keypad setting	0.5	1	2	4	8	16			
	at 1.5 x Ir	15	25	50	100	200	400				
	at 6 x Ir	0.5	1	2	4	8	16				
	at 7.2 x Ir	0.35	0.7	1.4	2.8	5.5	11				

### S Short-time protection with adjustable time delay

Pick-up (A) accuracy ±10 %	<b>Isd</b> = Ir x ... keypad settings	Adjustment in steps of 0.5 x Ir over the range 1.5 x Ir to 10 x Ir									
Time delay (ms)	<b>tsd</b>	I <sup>2</sup> Of	0	0.1	0.2	0.3	0.4				
	Keypad	I <sup>2</sup> On	-	0.1	0.2	0.3	0.4				
	Non-tripping time (ms)		20	80	140	230	350				
Maximum break time		80	140	200	320	500					

### I Instantaneous protection

Pick-up (A) accuracy ±15 %	<b>Ii</b> = In x ... keypad settings	Adjustment in steps of 0.5 x In over the range 1.5 x In to: 15 x In (40 to 160A), 12 x In (250 to 400A), or 12 x In (570A)								
Non-tripping time		10 ms								
Maximum break time		50 ms								

### R Earth leakage protection / Earth leakage alarm

Sensitivity (A)	Type A, adjustable (9 positions)									
	In = 40 A	IΔn = 0.03	0.03	0.1	0.3	0.5	1	3	5	OFF
	In = 100 A	IΔn = 0.03	0.03	0.1	0.3	0.5	1	3	5	OFF
	In = 160 A	IΔn = 0.03	0.03	0.1	0.3	0.5	1	3	5	OFF
	In = 250 A	IΔn = 0.03	0.03	0.1	0.3	0.5	1	3	5	OFF
	In = 400 A	IΔn = 0.3	0.3	0.5	1	3	5	10	10	OFF
	In = 570 A	IΔn = 0.3	0.3	0.5	1	3	5	10	10	OFF
Time delay Δt (ms)	Adjustable keypad	Δt = 0	60 [3]	150 [3]	500 [3]	1000 [3]				
	Maximum break time (ms)	<40	<140	<300	<800	<1500				

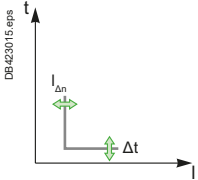

[1] For the use in high temperature environment, take into account the thermal limitation of the breaker.  
 [2] For the rating 40A, the N/2 adjustment is not possible  
 [3] The time delay (Δt) is mandatory and designed "Δt = 0" when the IΔn dial is set on 30mA (0.03). The time delay has no effect when the dial IΔn is set to the "OFF" position.



# Protection of distribution systems

## ComPact NSX Vigi add-on protection against insulation faults

B

There are two ways to add earth-leakage protection to any three or four-pole ComPact NSX100 to 630 circuit breaker equipped with a magnetic, thermal-magnetic or MicroLogic 2, 5 or 6 trip unit:

- by adding a Vigi add-on to the circuit breaker
- by using a Vigirex relay and separate toroids.

### Circuit breaker with Vigi add-on

- For general characteristics of circuit breakers, see pages A-6 and A-7.
- Vigi add-on. Earth-leakage protection is achieved by installing a Vigi add-on (characteristics and selection criteria on next page) directly on the circuit breaker terminals. It directly actuates the trip unit (magnetic, thermal-magnetic or MicroLogic).

### Circuit breaker combined with a Vigirex relay

#### ComPact NSX circuit breaker + Vigirex relay

Vigirex relays may be used to add external earth-leakage protection to ComPact NSX circuit breakers. The circuit breakers must be equipped with an MN or MX voltage release. The Vigirex relays add special tripping thresholds and time delays for earth-leakage protection.

Vigirex relays are very useful when faced with major installation constraints (circuit breaker already installed and connected, limited space available, etc.).

#### Vigirex-relay characteristics

- Sensitivity adjustable from 30 mA to 30 A and time-delay settings (0 to 4.5 seconds).
- Closed toroids up to 630 A (30 to 300 mm in diameter), opened toroids up to 250 A (80 to 120 mm in diameter) or rectangular sensors up to 630 A.
- 50/60 Hz distribution systems.

#### Options

- Trip indication by a fail-safe contact.
- Pre-alarm contact and LED, etc.

#### Compliance with standards

- IEC 60947-2, annex M.
- IEC/EN 60755: general requirements for residual-current operated protective devices.
- IEC/EN 61000-4-2 to 4-6: immunity tests.
- CISPR 11: Industrial, scientific and medical equipment - Radio-frequency disturbance characteristics - Limits and methods of measurement.
- UL1053 and CSA22.2 No. 144 for RH10, RH21 and RH99 relays at supply voltages up to and including 220/240 V.



PB105113.eps

ComPact NSX Vigi add-on.



PB100436.eps

Earth-leakage relay.



PB115226.eps

Separate toroids.

# Protection of distribution systems

## ComPact NSX Vigi add-on protection against insulation faults

### ComPact NSX Vigi add-on

Addition of the Vigi add-on does not modify circuit-breaker characteristics:

- compliance with standards
- degree of protection, class II front-face insulation
- positive contact indication
- electrical characteristics
- trip-unit characteristics
- installation and connection modes
- indication, measurement and control auxiliaries
- installation and connection accessories.

Dimensions and weights		NSX100/160/250	NSX400/630
Dimensions	3 poles	105 x 236 x 86	140 x 355 x 110
W x H x D (mm)	4 poles	140 x 236 x 86	185 x 355 x 110
Weight (kg)	3 poles	2.5	8.8
	4 poles	3.2	10.8

#### Compliance with standards

- IEC 60947-2, annex B.
- IEC 60755, Type A, immunity to DC components up to 6 mA.
- Operation down to -25 °C as per VDE 664.

#### Remote indications

Vigi add-on may be equipped with an auxiliary contact (SDV) to remotely signal tripping due to an earth fault.

#### Use of 4-pole Vigi add-on with a 3-pole ComPact NSX

In a 3-phase installation with an uninterrupted neutral, an accessory makes it possible to use a 4-pole Vigi add-on with connection of the neutral cable.

#### Power supply

Vigi add-on are self-powered internally by the distribution-system voltage and therefore do not require any external source. They continue to function even when supplied by only two phases.

### Vigi add-on selection

Type	Vigi ME	Vigi MH	Vigi MB
Number of poles	3, 4 <sup>[1]</sup>	3, 4 <sup>[1]</sup>	3, 4 <sup>[1]</sup>
NSX100	●	●	-
NXS160	●	●	-
NSX250	-	●	-
NSX400	-	-	●
NSX630	-	-	●

#### Protection characteristics

Sensitivity	fixed	adjustable	adjustable
I <sub>Δn</sub> (A)	0.3	0.03 - 0.3 - 1 - 3 - 10	0.3 - 1 - 3 - 10 - 30
Time delay	fixed	adjustable	adjustable
Intentional delay (ms)	< 40	0 - 60 <sup>[2]</sup> - 150 <sup>[2]</sup> - 310 <sup>[2]</sup>	0 - 60 - 150 - 310
Max. break time (ms)	< 40	< 40 < 140 < 300 < 800	< 40 < 140 < 300 < 800
Rated voltage V AC 50/60 Hz	200...440	200... 440 - 440...550	200...440 - 440...550

[1] Vigi 3P add-on may also be used on 3P circuit breakers used for two-phase protection.

[2] If the sensitivity is set to 30 mA, there is no time delay, whatever the time-delay setting.

### Operating safety

The Vigi add-on is a user safety device. It must be tested at regular intervals (every 6 months) via test button.



PE103560-36 eps

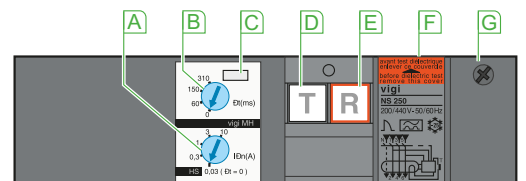

DB42378 eps

- A** Sensitivity setting
- B** Time-delay setting (for selective earth-leakage protection).
- C** Lead-seal fixture for controlled access to settings.
- D** Test button simulating an earth-fault for regular checks on the tripping function
- E** Reset button (reset required after earth-fault tripping).
- F** Rating plate
- G** Housing for SDV auxiliary contact.

#### Plug-in devices

The Vigi add-on can be installed on a plug-in base. Special accessories are required (see catalog number chapter).



Select your protection

## Protection of distribution systems

ComPact NSX and NSXm add-on protection against insulation faults using a Vigirex relay

### Detection

with associated toroid



### Alarm

with the Vigirex relay



### Protection

with the circuit breaker



### Function

Vigirex relays measure the earth-leakage current in an electrical installation via their associated toroids.

Vigirex relays may be used for:

- residual-current protection (RH10, RH21, RH68, RH86, RH99)
- earth-leakage monitoring (RMH or RH99)
- residual-current protection and earth-leakage monitoring (RH197, RHUs and RHU).

### Residual-current protection relay

Protection relays control the interruption of the supply of power to the monitored systems to protect:

- people against indirect contact and, in addition, against direct contact
- property against fire hazards
- motors.

A relay trips the associated circuit breaker when the set residual operating current  $I_{\Delta n}$  is overrun.

Depending on the relay, the threshold  $I_{\Delta n}$  can be fixed, user-selectable or adjustable and the overrun can be signalled by a digital display of the measured current or a LED.

The leakage current is displayed:

- for the RH197, on a bargraph made up of 4 LEDs indicating levels corresponding to 20, 30, 40 and 50 % of  $I_{\Delta n}$
- for the RHUs and RHU, by digital display of the value of the leakage current.

Circuit breaker tripping can be either instantaneous or delayed. On some relays, it is possible to adjust the time delay.

The protection relays store the residual-current fault in memory. Once the fault has been cleared and the output contact has been manually reset, the relay can be used again.

### Earth-leakage monitoring relays

These relays may be used to monitor drops in electrical insulation due to ageing of cables or extensions in the installation.

Continuous measurement of leakage currents makes it possible to plan preventive maintenance on the faulty circuits. An increase in the leakage currents may lead to a complete shutdown of the installation.

The control signal is issued by the relay when the residual-current operating threshold is overrun.

Depending on the relay, the threshold can be adjustable or user-selectable and the overrun can be signalled via a LED, a bargraph or a digital display of the measured current.

The leakage current is displayed:

- for the RH197, on a bargraph made up of 4 LEDs indicating levels corresponding to 20, 30, 40 and 50 % of  $I_{\Delta n}$
- for the RMH, by digital display of the value of the leakage current.

The control signal can be either instantaneous or delayed. On some relays, it is possible to adjust the time delay.

Earth-leakage monitoring relays do not store the residual-current fault in memory and their output contact is automatically reset when the fault is cleared.

### Use

Vigirex relays may be used for protection and maintenance at all levels in the installation. Depending on the relays, they may be used in TT, IT or TNS low-voltage AC installations for voltages up to 1000 V and frequencies 50/60 Hz. Vigirex protection relays are suitable for use with all electrical switchgear devices available on the market.





# Protection of distribution systems

## ComPact NSX and NSXm add-on protection against insulation faults using a Vigirex relay

Developed to be suitable for all installation systems, the Vigirex range provides real simplicity of choice and assembly.





### Overview of the Vigirex range

#### Protection relays

Device					
	RH10M&P	RH21M&P	RH99M&P	RH197M&P	RHUs/RHU
Functions					
Protection	<input checked="" type="radio"/>	<input checked="" type="radio"/>	<input checked="" type="radio"/>	<input checked="" type="radio"/>	<input checked="" type="radio"/>
Local indications	<input checked="" type="radio"/>	<input checked="" type="radio"/>	<input checked="" type="radio"/>	<input checked="" type="radio"/>	<input checked="" type="radio"/>
Remote indications	hard-wired			<input checked="" type="radio"/>	<input checked="" type="radio"/>
	via com Modbus SL				<input checked="" type="radio"/> except RHUs
Display of measurement				<input checked="" type="radio"/>	<input checked="" type="radio"/>

B

#### Monitoring relays

Device					
	RH99M&P	RH197M&P	RHUs/RHU	RMH	RM12T
Functions					
Protection		<input checked="" type="radio"/>	<input checked="" type="radio"/>		
Local indications	<input checked="" type="radio"/>	<input checked="" type="radio"/>	<input checked="" type="radio"/>	<input checked="" type="radio"/>	
Remote indications	<input checked="" type="radio"/>	<input checked="" type="radio"/>	<input checked="" type="radio"/>	<input checked="" type="radio"/>	
	hard-wired			<input checked="" type="radio"/>	
	via communication		<input checked="" type="radio"/> except RHUs	<input checked="" type="radio"/>	
Display of measurement		<input checked="" type="radio"/>	<input checked="" type="radio"/>	<input checked="" type="radio"/>	<input checked="" type="radio"/> 12 measurement channels

### Formats for all installation systems

Schneider MCB format devices in the Vigirex range can be mounted on a DIN rail (RH10, RH21, RH99 and RH197) or on a universal mounting plate using mounting lugs (RH10, RH21 and RH99). The 72 x 72 mm front-panel mount devices (RH10, RH21, RH99, RH197, RMH, RHUs and RHU) are mounted on panels, doors or front plates using clips.

Installation system	Suitable format	
	Front-panel mount	DIN rail
Main LV switchboard	<input checked="" type="radio"/>	
Power distribution switchboard	instrument zone	<input checked="" type="radio"/>
	modular-device zone	<input checked="" type="radio"/>
Motor Control Centre (MCC)		<input checked="" type="radio"/> with clip-in toroid
Automatic control panel or machine panel		<input checked="" type="radio"/> with mounting lugs
Final distribution enclosures		<input checked="" type="radio"/>

# ComPact NSX motor protection

## General information on motor feeders

B

The parameters to be considered for motor-feeder protection depend on:

- the application (type of machine driven, operating safety, frequency of operation, etc.)
- the level of continuity of service required by the load or the application
- the applicable standards for the protection of life and property.

The required electrical functions are:

- isolation
- switching, generally at high endurance levels
- protection against overloads and short-circuits, adapted to the motor
- additional special protection.

A motor feeder must comply with the requirements of standard IEC 60947-4-1 concerning contactors and their protection:

- coordination of feeder components
- thermal-relay trip classes
- contactor utilisation categories
- coordination of insulation.

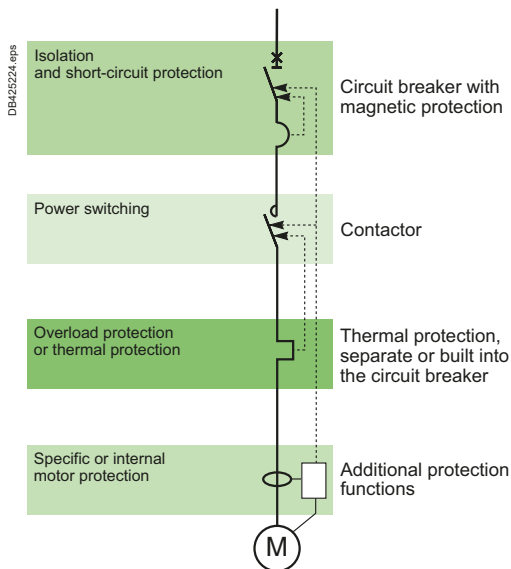
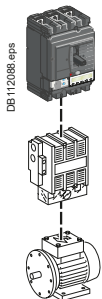

Switchgear functions in a motor feeder.

### Motor-feeder function

A motor feeder comprises a set of devices for motor protection and control, as well as for protection of the feeder itself.

#### Isolation

The purpose is to isolate the live conductors from the upstream distribution system to enable work by maintenance personnel on the motor feeder at no risk. This function is provided by a motor circuit breaker offering positive contact indication and lockout/tagout possibilities.

#### Switching

The purpose is to control the motor (ON / OFF), either manually, automatically or remotely, taking into account overloads upon start-up and the long service life required. This function is provided by a contactor. When the coil of the contactor's electromagnet is energised, the contactor closes and establishes, through the poles, the circuit between the upstream supply and the motor, via the circuit breaker.

#### Basic protection

##### Short-circuit protection

Detection and breaking, as quickly as possible, of high short-circuit currents to avoid damage to the installation. This function is provided by a magnetic or thermal-magnetic circuit breaker.

##### Overload protection

Detection of overload currents and motor shutdown before temperature rise in the motor and conductors damages insulation. This function is provided by a thermal-magnetic circuit breaker or a separate thermal relay.

#### Overloads: $I < 10 \times I_n$

They are caused by:

- an electrical problem, related to an anomaly in the distribution system (e.g. phase failure, voltage outside tolerances, etc.)
- a mechanical problem, related to a process malfunction (e.g. excessive torque) or damage to the motor (e.g. bearing vibrations).

These two causes will also result in excessively long starting times.

#### Impedant short-circuits: $10 \times I_n < I < 50 \times I_n$

This type of short-circuit is generally due to deteriorated insulation of motor windings or damaged supply cables.

#### Short-circuits: $I > 50 \times I_n$

This relatively rare type of fault may be caused by a connection error during maintenance.

#### Phase unbalance or phase loss protection

Phase unbalance or phase loss can cause temperature rise and braking torques that can lead to premature ageing of the motor. These effects are even greater during starting, therefore protection must be virtually immediate.

#### Additional electronic protection

- Locked rotor.
- Under-load.
- Long starts and stalled rotor.
- Insulation faults.

### Motor-feeder solutions

IEC 60947 defines three types of device combinations for the protection of motor feeders.

#### Three devices

- Magnetic circuit breaker + contactor + thermal relay.

#### Two devices

- Thermal-magnetic circuit breaker + contactor.

#### One device

- Thermal-magnetic circuit breaker + contactor in an integrated solution (e.g. Tesys U).

# ComPact NSX motor protection

## General information on motor feeders



### Device coordination

The various components of a motor feeder must be coordinated. Standard IEC 60947-4-1 defines three types of coordination depending on the operating condition of the devices following a standardised short-circuit test.

#### Type 1 coordination

- No danger to life or property.
- The contactor and/or the thermal relay may be damaged.
- Repair and replacement of parts may be required prior to further service.

#### Type 2 coordination

- No danger to life or property.
- No damage or adjustments are allowed. The risk of contact welding is accepted as long as they can be easily separated.
- Isolation must be maintained after the incident, the motor feeder must be suitable for further use without repair or replacement of parts.
- A rapid inspection is sufficient before return to service.

#### Total coordination

- No damage and no risk of contact welding is allowed for the devices making up the motor feeder. The motor feeder must be suitable for further use without repair or replacement of parts.

This level is provided by integrated 1-device solutions such as Tesys U.

### Contactor utilisation categories

For a given motor-feeder solution, the utilisation category determines the contactor withstand capacity in terms of frequency of operation and endurance. Selection, which depends on the operating conditions imposed by the application, may result in oversizing the contactor and circuit-breaker protection. IEC 60947 defines the following contactor utilisation categories.

#### Contactor utilisation categories (AC current)

Contactor utilisation categories	Type of load	Control function	Typical applications
AC-1	Non-inductive ( $\cos \varphi \geq 0.8$ )	Energising	Heating, distribution
AC-2	Slip-ring motor ( $\cos \varphi \geq 0.65$ )	Starting Switching off motor during running Counter-current braking Inching	Wiring-drawing machine
AC-3	Squirrel-cage motor ( $\cos \varphi = 0.45$ for $\leq 100$ A) ( $\cos \varphi = 0.35$ for $> 100$ A)	Starting Switching off motor during running	Compressors, elevators, pumps, mixers, escalators, fans, conveyer systems, air-conditioning
AC-4		Starting Switching off motor during running Regenerative braking Plugging Inching	Printing machines, wire-drawing machines

#### Utilisation category AC-3 - common coordination tables for circuit breakers and contactors

This category covers asynchronous squirrel-cage motors that are switched off during running, which is the most common situation (85 % of cases). The contactor makes the starting current and switches off the rated current at a voltage approximately one sixth of the nominal value. The current is interrupted without difficulty.

The circuit breaker-contactor coordination tables for ComPact NSX are for use with contactors in the AC-3 utilisation category, in which case they ensure type 2 coordination.

#### Utilisation category AC-4 - possible oversizing

This category covers asynchronous squirrel-cage motors capable of operating under regenerative braking or inching (jogging) conditions

The contactor makes the starting current and can interrupt this current at a voltage that may be equal to that of the distribution system.

These difficult conditions make it necessary to oversize the contactor and, in general, the protective circuit breaker with respect to category AC-3.

# ComPact NSX motor protection

## Motor-feeder characteristics and solutions

The trip class determines the trip curve of the thermal protection device (inverse-time curve) for a motor feeder. Standard IEC 60947-4-1 defines trip classes 5, 10, 20 and 30. These classes are the maximum durations, in seconds, for motor starting with a starting current of 7.2 I<sub>r</sub>, where I<sub>r</sub> is the thermal setting indicated on the motor rating plate.

Example: In class 20, the motor must have finished starting within 20 seconds (6 to 20 s) for a starting current of 7.2 I<sub>r</sub>.

### Trip class of a thermal-protection device

The motor feeder includes thermal protection that may be built into the circuit breaker. The protection must have a trip class suited to motor starting. Depending on the application, the motor starting time varies from a few seconds (no-load start) to a few dozen seconds (high-inertia load). Standard IEC 60947-4-1 defines the trip classes below as a function of current setting I<sub>r</sub> for thermal protection.

#### Trip class of thermal relays as a function of their I<sub>r</sub> setting

Class	1.05 I <sub>r</sub> [1]	1.2 I <sub>r</sub> [1]	1.5 I <sub>r</sub> [2]	7.2 I <sub>r</sub> [1]
5	t > 2 h	t < 2h	t < 2 mn	2 s < t ≤ 5 s
10	t > 2 h	t < 2h	t < 4 mn	4 s < t ≤ 10 s
20	t > 2 h	t < 2h	t < 8 mn	6 s < t ≤ 20 s
30	t > 2 h	t < 2h	t < 12 mn	9 s < t ≤ 30 s

[1] Time for a cold motor (motor off and cold).

[2] Time for warm motor (motor running under normal conditions).

### Currents of squirrel-cage motors at full rated load

#### Standardised values in HP

Rated operational power hp	Indicative values of the rated operational currents I <sub>e</sub> (A) for						
	110 - 120 V	200 V	208 V	220 - 240 V	380 - 415 V	440 - 480 V	550 - 600 V
1/2	4.4	2.5	2.4	2.2	1.3	1.1	0.9
3/4	6.4	3.7	3.5	3.2	1.8	1.6	1.3
1	8.4	4.8	4.6	4.2	2.3	2.1	1.7
1 1/2	12	6.9	6.6	6	3.3	3	2.4
2	13.6	7.8	7.5	6.8	4.3	3.4	2.7
3	19.2	11	10.6	9.6	6.1	4.8	3.9
5	30.4	17.5	16.7	15.2	9.7	7.6	6.1
7 1/2	44	25.3	24.2	22	14	11	9
10	56	32.2	30.8	28	18	14	11
15	84	48.3	46.2	42	27	21	17
20	108	62.1	59.4	54	34	27	22
25	136	78.2	74.8	68	44	34	27
30	160	92	88	80	51	40	32
40	208	120	114	104	66	52	41
50	260	150	143	130	83	65	52
60	-	177	169	154	103	77	62
75	-	221	211	192	128	96	77
100	-	285	273	248	165	124	99
125	-	359	343	312	208	156	125
150	-	414	396	360	240	180	144
200	-	552	528	480	320	240	192
250	-	-	-	604	403	302	242
300	-	-	-	722	482	361	289

Note: 1 hp = 0.7457 kW.

### Asynchronous-motor starting parameters

The main parameters of direct on-line starting of three-phase asynchronous motors (90 % of all applications) are listed below.

■ I<sub>r</sub>: rated current

This is the current drawn by the motor at full rated load (e.g. approximately 100 A rms for 55 kW at 400 V).

■ I<sub>d</sub>: starting current

This is the current drawn by the motor during starting, on average 7.2 I<sub>n</sub> for a duration t<sub>d</sub> of 5 to 30 seconds depending on the application (e.g. 720 A rms for 10 seconds). These values determine the trip class and any additional "long-start" protection devices that may be needed.

■ I<sup>'</sup><sub>d</sub>: peak starting current

This is the subtransient current during the first two half-waves when the system is energised, on the average 14 I<sub>n</sub> for 10 to 15 ms (e.g. 1840 A peak).

The protection settings must effectively protect the motor, notably via a suitable thermal-relay trip class, but let the peak starting current through.

#### Standardised values in kW

Rated operational power kW	Standardised values in kW currents I <sub>e</sub> (A) for:			
	230 V	400 V	500 V	690 V
0.06	0.35	0.32	0.16	0.12
0.09	0.52	0.3	0.24	0.17
0.12	0.7	0.44	0.32	0.23
0.18	1	0.6	0.48	0.35
0.25	1.5	0.85	0.68	0.49
0.37	1.9	1.1	0.88	0.64
0.55	2.6	1.5	1.2	0.87
0.75	3.3	1.9	1.5	1.1
1.1	4.7	2.7	2.2	1.6
1.5	6.3	3.6	2.9	2.1
2.2	8.5	4.9	3.9	2.8
3	11.3	6.5	5.2	3.8
4	15	8.5	6.8	4.9
5.5	20	11.5	9.2	6.7
7.5	27	15.5	12.4	8.9
11	38	22	17.6	12.8
15	51	29	23	17
18.5	61	35	28	21
22	72	41	33	24
30	96	55	44	32
37	115	66	53	39
45	140	80	64	47
55	169	97	78	57
75	230	132	106	77
90	278	160	128	93
110	340	195	156	113
132	400	230	184	134
160	487	280	224	162
200	609	350	280	203
250	748	430	344	250
315	940	540	432	313

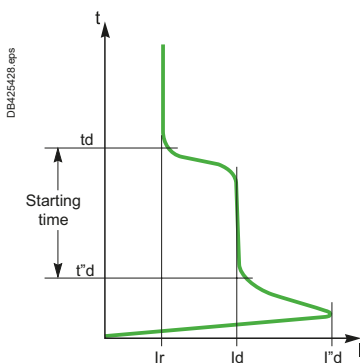

Typical motor-starting curve



# ComPact NSX motor protection

## Motor-feeder solutions

ComPact NSX motor circuit breakers are designed for motor-feeder solutions using:

- three devices, including an MA or 1.3 M magnetic-only trip unit
- two devices including a 2 M or 6 E-M electronic trip units.

They are designed for use with contactors in the AC-3 utilisation category (80 % of all cases) and they ensure type 2 coordination with the contactor.

For the AC-4 utilisation category, the difficult conditions generally make it necessary to oversize the protection circuit breaker with respect to the AC-3 category.

### ComPact NSX motor-protection range

ComPact NSX trip units can be used to create motor-feeder solutions comprising two or three devices. The protection devices are designed for continuous duty at 65 °C.





#### Three-device solutions

- 1 NSX circuit breaker with an MA or MicroLogic 1.3 M trip unit.
- 1 contactor.
- 1 thermal relay.

#### Two-device solutions

- 1 ComPact NSX circuit breaker
- with a MicroLogic 2.2 M or 2.3 M electronic trip unit
- with a MicroLogic 6 E-M electronic trip unit. This version offers additional protection and Power Meter functions.
- 1 contactor.

B

Type of motor protection		3 devices		2 devices	
ComPact NSX circuit breaker		NSX100/160/250	NSX400/630	NSX100 to 630	
Trip unit	Type 2 coordination with Type Technology	Contactor + thermal relay <b>MA</b> Magnetic 	<b>MicroLogic 1.3 M</b> Electronic 	<b>MicroLogic 2 M</b> Electronic 	<b>MicroLogic 6 E-M</b> Electronic 
Thermal relay	Separate	●	●		
	Built-in, class				
	5			●	●
	10			●	●
	20			●	●
	30				●
<b>Protection functions of ComPact NSX circuit breaker</b>					
Short-circuits		●	●	●	●
Overloads				●	●
Insulation faults	Ground-fault				●
Special motor functions	Phase unbalance			●	●
	Locked rotor				●
	Under-load				●
	Long start				●
<b>Built-in Power Meter functions</b>					
I, U, energy					●
<b>Operating assistance</b>					
Counters (cycles, trips, alarms, hours)					●
Contact-wear indicator					●
Load profile and thermal image					●

> Discover our specific Motor Protection Offer:

TeSys GV



MKTED210011EN

# ComPact NSX motor protection

## MA instantaneous trip units

MA magnetic trip units are used in 3 devices motor-feeder solutions. They can be mounted on all ComPact NSX100/160/250 circuit breakers with performance levels B/F/H/N/S/L. They provide short-circuit protection for motors up to 110 kW at 400 V.

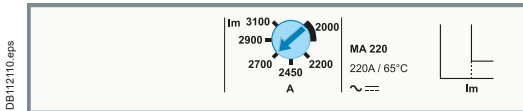

### MA magnetic trip units

In distribution applications, circuit breakers equipped with MA magnetic-only trip units are used for:

- short-circuit protection of secondary windings of LV/LV transformers with overload protection on the primary side.
- as an alternative to a switch-disconnector at the head of a switchboard in order to provide short-circuit protection.

Their main use is however for motor protection applications, in conjunction with a thermal relay and a contactor or motor starter.

### Protection

#### Magnetic protection (Im)

Short-circuit protection with an adjustable pick-up  $I_m$  that initiates instantaneous tripping if exceeded.

- $I_m = I_n \times \dots$  set in amps on an adjustment dial covering the range 6 to 14 x  $I_n$  for 2.5 to 100 A ratings or 9 to 14  $I_n$  for 150 to 220 A ratings.

#### Protection versions

- 3-pole (3P 3D): 3-pole frame (3P) with detection on all 3 poles (3D).
- 4-pole (4P 3D): 4-pole frame (4P) with detection on 3 poles (3D).

### Magnetic trip units MA 2.5 to 220

Ratings (A)	$I_n$ at 65 °C [1]	2.5	6.3	12.5	25	50	100 [1]	150	220	
Circuit breaker	ComPact NSX100	●	●	●	●	●	●	-	-	
	ComPact NSX160	-	-	-	●	●	●	●	-	
	ComPact NSX250	-	-	-	-	-	●	●	●	
<b>Instantaneous magnetic protection</b>										
Pick-up (A) accuracy ±20 %	$I_m = I_n \times \dots$	Adjustable from 6 to 14 x $I_n$ (settings 6, 7, 8, 9, 10, 11, 12, 13, 14)						Adjustable from 9 to 14 x $I_n$ (settings 9, 10, 11, 12, 13, 14)		
Time delay (ms)	$t_m$	fixed								

[1] MA100 3P adjustable from 6 to 14 x  $I_n$ .  
MA100 4P adjustable from 9 to 14 x  $I_n$ .

**Note:** all the trip units have a transparent lead-sealable cover that protects access to the adjustment dials.

B

# ComPact NSX motor protection

## MicroLogic 1.3 M instantaneous trip units

MicroLogic 1.3 M trip units are used in 3 devices motor-feeder solutions on ComPact NSX400/630 circuit breakers with performance levels B/F/H/N/S/L.

They provide short-circuit protection for motors up to 250 kW at 400 V.

They also provide the benefits of electronic technology:

- accurate settings
- tests
- "Ready" LED.

### MicroLogic 1.3 M trip units

Circuit breakers with a MicroLogic 1.3 M trip unit are combined with a thermal relay and a contactor.

### Protection

Settings are made using a dial.

#### Short-circuits: Short-time protection (I<sub>sd</sub>)

Protection with an adjustable pick-up I<sub>sd</sub>. There is a very short delay to let through motor starting currents.

- I<sub>sd</sub> is set in amperes from 5 to 13 x I<sub>n</sub>, as follows:
  - from 1600 to 4160 A for the 320 A rating
  - from 2500 to 6500 A for the 500 A rating.

#### Short-circuits: Non-adjustable instantaneous protection (I<sub>i</sub>)

Instantaneous protection with non-adjustable pick-up I<sub>i</sub>.

#### Protection version

- 3-pole (3P 3D): 3-pole frame (3P) equipped with detection on all 3 poles (3D).

### Indications

#### Front indications

- Green "Ready" LED: flashes slowly when the circuit breaker is ready to trip in the event of a fault.

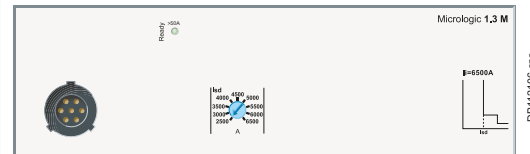

B

### MicroLogic 1.3 M

	Ratings (A)	I <sub>n</sub> at 65 °C [1]	320	500
Circuit breaker		ComPact NSX400	●	-
		ComPact NSX630	●	●
<b>S Short-time protection</b>				
Pick-up (A) accuracy ±15 %	I <sub>sd</sub>	Adjustable directly in amps		
		9 settings: 1600, 1920, 2440, 2560, 2880, 3200, 3520, 3840, 4160 A		
		9 settings: 2500, 3000, 3500, 4000, 4500, 5000, 5500, 6000, 6500 A		
Time delay (ms)	t <sub>sd</sub>	Non-adjustable		
	Non-tripping time	10		
	Maximum break time	60		
<b>I Instantaneous protection</b>				
Pick-up (A) accuracy ±15 %	I <sub>i</sub> non-adjustable	4800	6500	
	Non-tripping time	0		
	Maximum break time	30 ms		

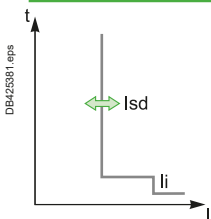

[1] Motor standards require operation at 65 °C. Circuit-breaker ratings are derated to take this requirement into account (see pages E-14 to E-17).

# ComPact NSX motor protection

## MicroLogic 2.2 / 2.3 M electronic trip units

MicroLogic 2.2 / 2.3 M trip units provide built-in thermal and magnetic protection. They are used in 2 devices motor-feeder solutions on ComPact NSX100 to 630 circuit breakers with performance levels B/F/H/N/S/L. They provide protection for motors up to 315 kW at 400 V against:

- short-circuits
- overloads with selection of a trip class (5, 10 or 20)
- phase unbalance.

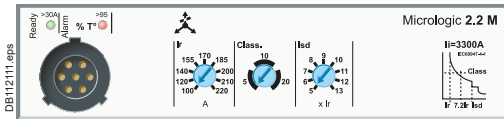

Circuit breakers with a MicroLogic 2.2 / 2.3 M trip unit include protection similar to an inverse-time thermal relay. They are combined with a contactor.

### Protection

Settings are made using a dial.

#### Overloads (or thermal protection): Long-time protection and trip class (Ir)

Inverse-time thermal protection against overloads with adjustable pick-up Ir. Settings are made in amperes. The tripping curve for the long-time protection, which indicates the time delay tr before tripping, is defined by the selected trip class.

#### Trip class (class)

The class is selected as a function of the normal motor starting time.

- Class 5: starting time less than 5 s.
- Class 10: starting time less than 10 s.
- Class 20: starting time less than 20 s.

For a given class, it is necessary to check that all motor-feeder components are sized to carry the 7.2 Ir starting current without excessive temperature rise during the time corresponding to the class.

#### Short-circuits: Short-time protection (Isd)

Protection with an adjustable pick-up Isd. There is a very short delay to let through motor starting currents.

#### Short-circuits: Non-adjustable instantaneous protection (Ii)

Instantaneous protection with non-adjustable pick-up Ii.

#### Phase unbalance or phase loss (Iunbal) (I<sub>unbal</sub>)

This function opens the circuit breaker if a phase unbalance occurs:

- that is greater than the 30 % fixed pick-up Iunbal
- following the non-adjustable time delay tunbal equal to:
  - 0.7 s during starting
  - 4 s during normal operation.

Phase loss is an extreme case of phase unbalance and leads to tripping under the same conditions.

### Indications

#### Front indications

- Green "Ready" LED: flashes slowly when the circuit breaker is ready to trip in the event of a fault.
- Red alarm LED for motor operation: goes ON when the thermal image of the rotor and stator is greater than 95 % of the permissible temperature rise.

#### Remote indications via SDTAM module

ComPact NSX devices with a MicroLogic 2 can be equipped with an SDTAM module dedicated to motor applications for:

- a contact to indicate circuit-breaker overload
- a contact to open the contactor. In the event of a phase unbalance or overload, this output is activated 400 ms before circuit-breaker tripping to open the contactor and avoid circuit breaker tripping.

This module takes the place of the MN/MX coils and an OF contact.

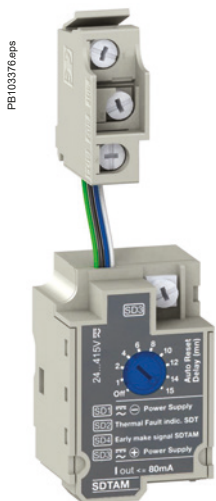

SDTAM remote indication relay module with its terminal block.

**Note:** all the trip units have a transparent lead-sealable cover that protects access to the adjustment dials.

# ComPact NSX motor protection

## MicroLogic 2.2 / 2.3 M electronic trip units

### MicroLogic 2.2 / 2.3 M

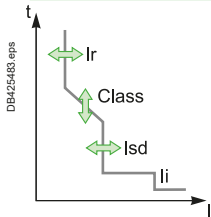

Ratings (A)	In at 65 °C [1]	25	50	100	150	220	320	500
Circuit breaker	ComPact NSX100	●	●	●	-	-	-	-
	ComPact NSX160	●	●	●	●	-	-	-
	ComPact NSX250	●	●	●	●	●	-	-
	ComPact NSX400	-	-	-	-	-	●	-
	ComPact NSX630	-	-	-	-	-	●	●

#### L Overloads (or thermal protection): Long-time protection and trip class

Pick-up (A) tripping between 1.05 and 1.20 Ir	Ir	value depending on trip unit rating (In) and setting on dial									
In = 25 A	Ir =	12	14	16	18	20	22	23	24	25	
In = 50 A	Ir =	25	30	32	36	40	42	45	47	50	
In = 100 A	Ir =	50	60	70	75	80	85	90	95	100	
In = 150 A	Ir =	70	80	90	100	110	120	130	140	150	
In = 220 A	Ir =	100	120	140	155	170	185	200	210	220	
In = 320 A	Ir =	160	180	200	220	240	260	280	300	320	
In = 500 A	Ir =	250	280	320	350	380	400	440	470	500	
Trip class as per IEC 60947-4-1		5	10	20							

Time delay (s) depending on selected trip class	tr	1.5 x Ir	6 x Ir	7.2 x Ir	120	240	480	for warm motor			
					6.5	13.5	26	for cold motor			
					5	10	20	for cold motor			

Thermal memory		20 minutes before and after tripping									
Cooling fan		non-adjustable - motor self-cooled									

#### S<sub>0</sub> Short-circuits: Short-time protection with fixed time delay

Pick-up (A) accuracy ±15 %	Isd = Ir x ...	5	6	7	8	9	10	11	12	13
Time delay (ms)	tsd	non-adjustable								
	Non-tripping time	10								
	Maximum break time	60								

#### I Short-circuits: Non-adjustable instantaneous protection

Pick-up (A) accuracy ±15 %	Ii non-adjustable	425	750	1500	2250	3300	4800	6500	
Time delay (ms)	Non-tripping time	0							
	Maximum break time	30							

#### Phase unbalance or phase loss

Pick-up (A) accuracy ±20 %	Iunbal in % average current [2]	> 30 %
Time delay (s)	non-adjustable	0.7 s during starting 4 s during normal operation

[1] Motor standards require operation at 65 °C. Circuit-breaker ratings are derated to take this requirement into account (see pages E-14 to E-17).

[2] The unbalance measurement takes into account the most unbalanced phase with respect to the average current.



# ComPact NSX motor protection

## MicroLogic 6 E-M electronic trip units

MicroLogic 6.E-M is used in 2 devices motor-feeder solutions. It provides the same protection as MicroLogic 2 M:

- short-circuits
- overloads with selection of the same trip classes (5, 10 or 20), plus trip class 30 for starting of machines with high inertia.

In addition, it offers specific motor-protection functions that can be set via the keypad.

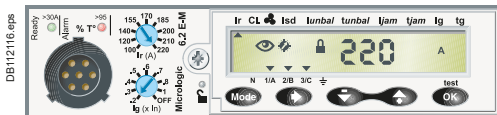

### Protection

The protection functions are identical to those of MicroLogic 2 M and can be fine-adjusted via the keypad.

Access to setting modifications via the keypad is protected by a locking function that is controlled by a microswitch. The lock is activated automatically if the keypad is not used for 5 minutes. Access to the microswitch is protected by a transparent lead-sealable cover. It is possible to scroll through settings and measurements with the cover closed.

#### Overloads (or thermal), class and short-circuits

The long-time, short-time and instantaneous functions are identical to those of MicroLogic 2 M.

In addition, there is trip class 30 for long-time protection and a setting for self-cooled or fan-cooled motors.

#### Ground-fault protection (I<sub>g</sub>)

Residual type ground-fault protection with an adjustable pick-up **I<sub>g</sub>** (with Off position) and adjustable time delay **t<sub>g</sub>**.

#### Phase unbalance or phase loss (I<sub>unbal</sub>)

This function opens the circuit breaker if a phase unbalance occurs:

- that is greater than the **I<sub>unbal</sub>** pick-up that can be fine-adjusted from 10 to 40 % (30 % by default)

- following the **t<sub>unbal</sub>** time delay that is:

- 0.7 s during starting
- adjustable from 1 to 10 seconds (4 seconds by default) during normal operation.

Phase loss is an extreme case of phase unbalance and leads to tripping under the same conditions.

#### Locked rotor (I<sub>jam</sub>)

This function detects locking of the motor shaft caused by the load.

During motor starting (see page B-37), the function is disabled.

During normal operation, it causes tripping:

- above the **I<sub>jam</sub>** pick-up that can be fine-adjusted from 1 to 8 x I<sub>r</sub>
- in conjunction with the **t<sub>jam</sub>** time delay that can be adjusted from 1 to 30 seconds.

#### Under-load (I<sub>und</sub>)

This function detects motor no-load operation due to insufficient load (e.g. a drained pump). It detects phase undercurrent.

During motor starting (see page B-37), the function is always enabled.

During normal operation, it causes tripping:

- below the **I<sub>und</sub>** pick-up that can be fine-adjusted from 0.3 to 0.9 x I<sub>r</sub>
- in conjunction with the **t<sub>und</sub>** time delay that can be adjusted from 1 to 200 seconds.

#### Long starts (I<sub>long</sub>)

This protection supplements thermal protection (class).

It is used to better adjust protection to the starting parameters.

It detects abnormal motor starting, i.e. when the starting current remains too high or too low with respect to a pick-up value and a time delay.

It causes tripping:

- in relation with a **I<sub>long</sub>** pick-up that can be fine-adjusted from 1 to 8 x I<sub>r</sub>
- in conjunction with the **t<sub>long</sub>** time delay that can be adjusted from 1 to 200 seconds (see "long starts" page B-37).

**Note:** all the trip units have a transparent lead-sealable cover that protects access to the adjustment dials.

# ComPact NSX motor protection

## MicroLogic 6 E-M electronic trip units

B

### Display of type of fault

On a fault trip, the type of fault (Ir, Isd, li, Ig, lunbal, ljam), the phase concerned and the interrupted current are displayed.

### Indications

#### Front indications

- Green "Ready" LED: flashes slowly when the circuit breaker is ready to trip in the event of a fault.
- Red alarm LED for motor operation: goes ON when the thermal image of the rotor or stator is greater than 95% of the permissible temperature rise.

#### Remote indications via SDTAM or SDx module

See description on page C-31 for SDTAM and for SDx.

### MicroLogic 6.2 / 6.3 E-M

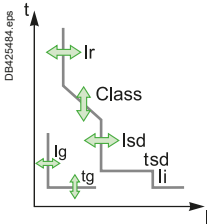

Ratings (A)	In at 65 °C [1]	25	50	80	150	220	320	500
Circuit breaker	ComPact NSX100	●	●	●	-	-	-	-
	ComPact NSX160	●	●	●	●	-	-	-
	ComPact NSX250	●	●	●	●	●	-	-
	ComPact NSX400	-	-	-	-	-	●	-
	ComPact NSX630	-	-	-	-	-	●	●

#### L Overloads: Long-time protection

Pick-up (A)	Ir	Dial setting	Value depending on trip-unit rating (In) and setting on dial									
Tripping between 1.05 and 1.20 Ir		In = 25 A Ir =	12	14	16	18	20	22	23	24	25	
		In = 50 A Ir =	25	30	32	36	40	42	45	47	50	
		In = 80 A Ir =	35	42	47	52	57	60	65	72	80	
		In = 150 A Ir =	70	80	90	100	110	120	130	140	150	
		In = 220 A Ir =	100	120	140	155	170	185	200	210	220	
		In = 320 A Ir =	160	180	200	220	240	260	280	300	320	
		In = 500 A Ir =	250	280	320	350	380	400	440	470	500	
		Keypad setting	Fine adjustments in 1 A steps below maximum value defined by dial setting									
Trip class as per IEC 60947-4-1			5	10	20	30						
Time delay (s) depending on selected trip class	tr	1.5 x Ir	120	240	480	720	for warm motor					
		6 x Ir	6.5	13.5	26	38	for cold motor					
		7.2 x Ir	5	10	20	30	for cold motor					
Thermal memory			20 minutes before and after tripping									
Cooling fan			Settings for self-cooled or fan-cooled motors									

#### S<sub>n</sub> Short-circuits: Short-time protection with fixed time delay

Pick-up (A) accuracy ±15 %	Isd = Ir x ...	5	6	7	8	9	10	11	12	13	
Time delay	tsd	non-adjustable									
	Non-tripping time	10 ms									
	Maximum break time	60 ms									

#### I Short-circuits: Non-adjustable instantaneous protection

Pick-up (A) accuracy ±15 %	li non-adjustable	425	750	1200	2250	3300	4800	6500	
	Non-tripping time	0 ms							
	Maximum break time	30 ms							

#### G Ground faults

Pick-up (A) accuracy ±10 %	Ig = In x ...	Dial setting										
	In = 25 A Ig =	0.6	0.6	0.6	0.6	0.7	0.8	0.9	1	Off		
	In = 50 A Ig =	0.3	0.4	0.5	0.6	0.7	0.8	0.9	1	Off		
	In > 50 A Ig =	0.2	0.3	0.4	0.5	0.6	0.7	0.8	1	Off		
		fine adjustments in 0.05 x In steps										
Time delay (ms)	tg	0	0.1	0.2	0.3	0.4						
	Non-tripping time	20	80	140	230	350						
	Maximum break time	80	140	200	320	500						

[1] Motor standards require operation at 65 °C. Circuit-breaker ratings are derated to take this requirement into account (see pages E-14 to E-17).  
 [2] The unbalance measurement takes into account the most unbalanced phase with respect to the average current.

# ComPact NSX motor protection

## MicroLogic 6 E-M electronic trip units

### MicroLogic 6.2 / 6.3 E-M

#### Phase unbalance or phase loss

Pick-up (A) accuracy $\pm 20\%$	<b>lunbal</b> = in % average current <sup>[2]</sup>	adjustable from 10 to 40 %, default setting = 30 % fine adjustments in 1 % steps using the keypad activated during motor starting
Time delay (s)	<b>tunbal</b>	0.7 s during starting 1 to 10 seconds during normal operation, default setting = 4 seconds fine adjustments in 1 s steps using the keypad

#### Locked rotor

Pick-up (A) accuracy $\pm 10\%$	<b>ljam</b> = $I_r \times \dots$	1 x 8 $I_r$ with Off position, default setting = Off fine adjustments in 0.1 x $I_r$ steps using the keypad disabled during motor starting
Time delay (s)	<b>tjam</b> =	1 to 30 seconds fine adjustments in 1 s steps using the keypad, default setting = 5 s

#### Under-load (under-current)

Pick-up (A) accuracy $\pm 10\%$	<b>lund</b> = $I_r \times \dots$	0.3 x 0.9 $I_r$ with Off position, default setting = Off Fine adjustments in $I_r \times 0.01$ steps using the EcoStruxure Power Commission software activated during motor starting
Time delay (s)	<b>tund</b> =	1 to 200 seconds fine adjustments in 1 s steps using the EcoStruxure Power Commission software, default setting = 10 s

#### Long starts

Pick-up (A) accuracy $\pm 10\%$	<b>llong</b> = $I_r \times \dots$	1 x 8 $I_r$ with Off position, default setting = Off Fine adjustments in $I_r \times 0.1$ steps using the EcoStruxure Power Commission software activated during motor starting
Time delay (s)	<b>tlong</b> =	1 to 200 seconds fine adjustments in 1 s steps using the EcoStruxure Power Commission software, default setting = 10 s

[1] Motor standards require operation at 65 °C. Circuit-breaker ratings are derated to take this requirement into account (see pages E-14 to E-17).

[2] The unbalance measurement takes into account the most unbalanced phase with respect to the average current.

B



## Additional technical characteristics

### Phase unbalance

An unbalance in three-phase systems occurs when the three voltages are not equal in amplitude and/or not displaced 120° with respect to each other. It is generally due to single-phase loads that are incorrectly distributed throughout the system and unbalance the voltages between the phases.

These unbalances create negative current components that cause braking torques and temperature rise in asynchronous machines, thus leading to premature ageing.

### Phase loss

Phase loss is a special case of phase unbalance.

- During normal operation, it produces the effects mentioned above and tripping must occur after four seconds.
- During starting, the absence of a phase may cause motor reversing, i.e. it is the load that determines the direction of rotation. This requires virtually immediate tripping (0.7 seconds).

### Starting time in compliance with the class (MicroLogic 2 M)

For normal motor starting, MicroLogic 2 M checks the conditions below with respect to the thermal-protection (long-time) pick-up  $I_r$ :

- current  $> 10\% \times I_r$  (motor-off limit)
- overrun of  $1.5 \times I_r$  threshold, then return below this threshold before the end of a 10 s time delay.

If either of these conditions is not met, the thermal protection trips the device after a maximum time equal to that of the selected class.

Pick-up  $I_r$  must have been set to the current indicated on the motor rating plate.

### Long starts (MicroLogic 6 E-M)

When this function is not activated, the starting conditions are those indicated above.

When it is activated, this protection supplements thermal protection (class).

A long start causes tripping and is characterised by:

- current  $> 10\% \times I_r$  (motor-off limit) with:
  - either overrun of the long-time pick-up ( $1$  to  $8 \times I_r$ ) without return below the pick-up before the end of the long-time time delay ( $1$  to  $200$  s)
  - or no overrun of the long-time pick-up ( $1$  to  $8 \times I_r$ ) before the end of the long-time time delay ( $1$  to  $200$  s).

Pick-up  $I_r$  must have been set to the current indicated on the motor rating plate.

This protection should be coordinated with the selected class.

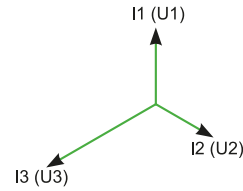

Unbalance of phase currents and voltages.

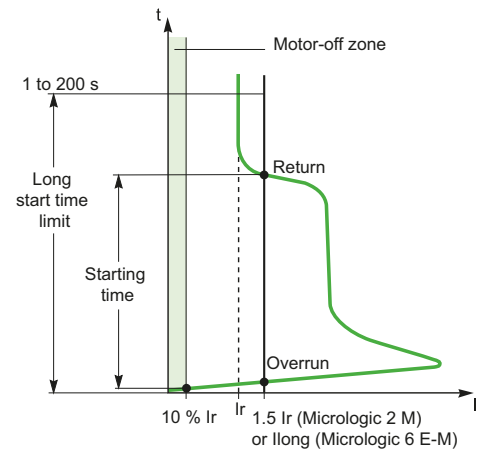

Motor starting and long starts.

DB425420 eps

DB425430 eps



# ComPact NSX measurement

## MicroLogic 5 / 6 / 7 E electronic trip units

ComPact NSX with its embedded current sensors handled by a microprocessor that operates independently of protection functions and MicroLogic 5 / 6 / 7 E is a PMD-DD Power Meter Device complying with IEC/EN 61557-12, Class 0.5 for voltage, Class 1 for current and Class 2 for active power and energy measurements.

B

### Measures and electrical parameters calculated by the MicroLogic 5 / 6 / 7 E trip units

Based on the measure of line currents, neutral current, phase to phase voltages and phase to neutral voltages, the MicroLogic 5 / 6 / 7 E trip units calculate and display all the parameters required to monitor any AC electrical power supply including power quality, power management and energy efficiency:

- RMS values of currents and voltages,
- Active, reactive and apparent powers, active, reactive and apparent energies,
- Power factor,
- Frequency,
- Unbalance on voltage and THD of voltages and currents,
- Demand and maximum demand values.

The maximum and minimum values are stored in the MicroLogic 5 / 6 / 7 E trip units non volatile memory. They are resettable from the embedded display, FDM display or a PC running EcoStruxure Power Commission software.

### Demand and maximum demand values

MicroLogic E also calculates demand current and power values. These calculations can be made using a block or sliding interval that can be set from 5 to 60 minutes in steps of 1 minute. The window can be synchronised with a signal sent via the communication system. Whatever the calculation method, the calculated values can be recovered on a PC via Modbus communication.

Ordinary spreadsheet software can be used to provide trend curves and forecasts based on this data. They will provide a basis for load shedding and reconnection operations used to adjust consumption to the subscribed power.

Electrical values can be displayed on the embedded HMI, a PC running EcoStruxure Power Commission software and on the FDM display unit.

They are refreshed every second.

The display on the embedded HMI is accessed by means of a contextual menu allowing to navigate easily through the electrical values. Alternatively a Quickview option allows to display the main basic values.

Optional external 24 Vdc supply module is required to process and display the measurements including energy counters for currents below 20 % of the rated current.

The phase to neutral voltages are available for 4 poles circuit breakers and 3 poles circuit breakers as well providing the connection of the MicroLogic 5 / 6 E to the neutral (ENVT). To guarantee the accuracy for the active power measurement this connection is mandatory.

Neutral-Phase measurement is only possible on the 4-pole MicroLogic Vigi 7 E (not on the 3-pole).

No External Neutral connection on the MicroLogic Vigi 7 E.

Please refer to the user manual for more details concerning the wiring and the configuration of MicroLogic 5 / 6 / 7 E.

# ComPact NSX measurement MicroLogic 5 / 6 / 7 E electronic trip units

B

## MicroLogic 5 / 6 / 7 E for energy management functions

Active Power and Energy metering in ComPact NSX with MicroLogic 5 / 6 / 7 E has been designed and tested to provide accuracy: **Class 2 according to IEC/EN 61557-12**. This standard specifies requirements for combined performance of measuring and monitoring devices that measure and monitor the electrical parameters within electrical distribution systems. It covers both devices with external sensors such as current and/or voltage transformers like stand alone power meter (PMD-S) and devices with embedded sensors (PMD-D) like circuit breakers.

In addition a list of available performance class for all relevant measurement functions is specified in IEC/EN 61557-12, in opposition to most other standards such as IEC 62053-2x series that are dealing only with active and reactive energy.

ComPact NSX equipped with MicroLogic 5 / 6 / 7 E and its own embedded sensors is a Class 2 full chain measurement PMD-DD device for active power and energy metering according to IEC/EN 61557-12.

PMD-DD offer the benefit of avoiding uncertainty and variation due to external sensors and wiring.

IEC/EN 61557-12 standard defines three levels of uncertainty (intrinsic uncertainty, operating uncertainty, overall system uncertainty) that need to be checked to ensure accuracy class.

The uncertainty is the estimated amount or percentage by which a measured value may differ from the true value. According to IEC/EN 61557-12, the total uncertainty of a measurement, in general, depends on the instrument, the environment, and other elements to be considered.

**Note:** Requirements for Class 2 active power and energy in IEC/EN 61557-12 regarding limits of uncertainty due to variation of the current for different power factor, and limits of uncertainty due to influence quantities such as temperature are equivalent to IEC 62053-2x standards.

### PMD-D - Embedded sensors

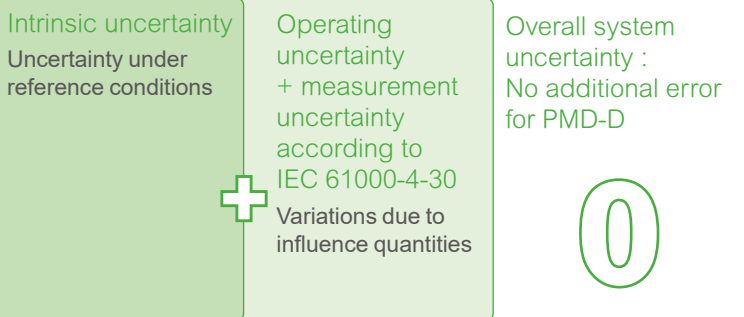

### PMD-S - External sensors

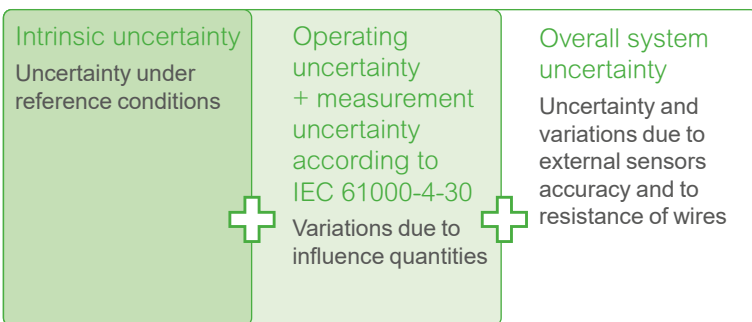

PMD-D - Embedded sensors

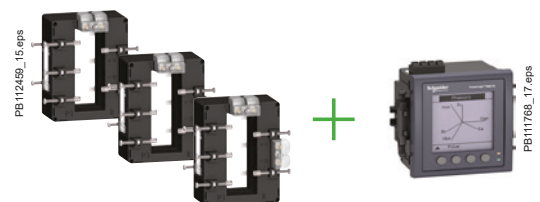

PMD-S - External sensors

# ComPact NSX measurement

## MicroLogic 5 / 6 / 7 E electronic trip units



### Compliance with ISO 50001: Reliability and repeatability over time of energy measurement

#### Scope and main requirements of ISO 50001:

ISO 50001 specifies requirements for systems and organization dedicated to energy management. This international standard defines rules and gives recommendations to achieve continual improvement of energy performance, including energy efficiency, energy use and consumption, measurements, documentation and reporting. Energy performance shall be monitored and significant deviations shall be investigated. It implies that the accuracy of the instruments used for this purpose remains stable throughout their entire operating life which ensures the repeatability of the measurements (ISO 50001, clause 4.6 and 4.6.1 Checking, monitoring, measurement and analysis).

In ComPact NSX with MicroLogic 5 / 6 / 7 E, the metering and protection functions are designed to perform accurate and repeatable measurements during MicroLogic E life time, provided it's used in the specified environmental conditions as defined in ComPact NSX User Guide. Current sensors and MicroLogic E are calibrated during circuit breaker manufacturing and are not supposed to be re-calibrated during this life time. In general, electronic instrument measuring electric parameters don't request any specific maintenance provided they are working within environmental specifications. Accuracy can be reduced in case of operation under exceptional conditions, lightning strikes, high temperature, high degree of humidity, this is why a periodic verification is recommended (please refer to the annex I of the AFNOR Document FD X30-147: Metrological maintenance recommendations, applicable to electrical and fluidic measurements).

### IEC 60364-8-1 Clause 8.3.1.1 Requirement on accuracy and measuring range

#### Scope and main requirements of IEC 60364-8-1:

IEC 60364-8-1 provides requirements and recommendations for the design, erection and verification of low voltage electrical installations including local production and storage of energy for optimizing the overall efficient use of electricity. It introduces recommendations for the design of an electrical installation within the framework of an energy efficiency management approach in order to get low electrical energy consumption and acceptable energy availability. It also specifies the accuracies of the measuring instruments involved in the functions of energy management such as:

- Energy usage analysis and optimization
- Contract optimization
- Cost allocation
- Efficiency assessment
- Energy usage trends assessment.

ComPact NSX with MicroLogic 5 / 6 / 7 E complies with the requirements of IEC 60364-8-1 dedicated to the optimization of energy efficiency. It provides a range of measurements with accuracies required for complex energy efficiency approaches.

The table below from IEC 60364-8-1:2014 Clause 8.3.1.1 "Requirement on accuracy and measuring range" specifies the accuracies required for the measurements dedicated to cost management

	Incomer	ComPact NSX main applications		Final distribution board
		Main LV switchboard	Intermediate distribution boards	
<b>Measurement objectives for cost management</b>	<ul style="list-style-type: none"> <li>■ Revenue metering</li> <li>■ Bill checking</li> <li>■ Energy usage analysis and optimization</li> <li>■ Contract optimization</li> <li>■ Regulatory compliance</li> </ul>	<ul style="list-style-type: none"> <li>■ Cost allocation</li> <li>■ Energy usage analysis and optimization</li> <li>■ Efficiency assessment</li> <li>■ Contract optimization</li> <li>■ Regulatory compliance</li> </ul>	<ul style="list-style-type: none"> <li>■ Cost allocation</li> <li>■ Energy usage analysis and optimization</li> <li>■ Efficiency assessment</li> <li>■ Contract optimization</li> <li>■ Regulatory compliance</li> </ul>	<ul style="list-style-type: none"> <li>■ Energy usage analysis and optimization</li> <li>■ Energy usage trends assessment</li> </ul>
<b>Overall system accuracy of active energy measurement</b>	In general, excellent accuracy, e.g. class 0.2 to class 1	In general, good accuracy, e.g. class 0.5 to class 2	In general, medium accuracy, e.g. class 1 to class 3	In general, reliable indication should be more important than accuracy

# ComPact NSX measurement MicroLogic 5 / 6 / 7 E electronic trip units



MicroLogic 5 / 6 / 7 integrated Power Meter functions			Type		Display	
			A	E	MicroLogic LCD	FDM display
<b>Display of protection settings</b>						
Pick-ups (A) and delays	Settings MicroLogic 5 / 6	I <sub>r</sub> , tr, I <sub>sd</sub> , t <sub>sd</sub> , I <sub>i</sub> , I <sub>g</sub> , t <sub>g</sub>	●	●	●	-
	Settings MicroLogic Vigi 7 E [4]	I <sub>r</sub> , tr, I <sub>sd</sub> , t <sub>sd</sub> , I <sub>i</sub> , I <sub>Δn</sub> , Δt, I <sub>Δn</sub> % pre-alarm		●	●	
<b>Measurements</b>						
<b>Instantaneous rms measurements</b>						
Currents (A)	Phases and neutral	I1, I2, I3, IN	●	●	●	●
	Average of phases	I <sub>avg</sub> = (I1 + I2 + I3) / 3	●	●	-	●
	Highest current of the 3 phases and neutral	I <sub>max</sub> of I1, I2, I3, IN	●	●	●	●
	Ground fault (MicroLogic 6)	% I <sub>g</sub> (pick-up setting)	●	●	●	●
	Earth leakage (MicroLogic Vigi 7 E)	% I <sub>Δn</sub> (pick-up setting)	-	●	-	-
	Highest Earth Leakage current	I <sub>Δn</sub> max	-	●	-	-
	Current unbalance between phases	% I <sub>avg</sub>	-	●	-	●
Voltages (V)	Phase-to-phase	U12, U23, U31	-	●	●	●
	Phase-to-neutral	V1N, V2N, V3N	-	●	●	●
	Average of phase-to-phase voltages	U <sub>avg</sub> = (U12 + U21 + U23) / 3	-	●	-	●
	Average of phase-to-neutral voltages	V <sub>avg</sub> = (V1N + V2N + V3N) / 3	-	●	-	●
	Ph-Ph and Ph-N voltage unbalance	% U <sub>avg</sub> and % V <sub>avg</sub>	-	●	-	●
	Phase sequence	1-2-3, 1-3-2	-	●	●	● [3]
Frequency (Hz)	Power system	f	-	●	-	●
Power	Active (kW)	P, total / per phase	- / -	● / ●	● / -	● / ●
	Reactive (kVAR)	Q, total / per phase	- / -	● / ●	● / -	● / ●
	Apparent (kVA)	S, total / per phase	- / -	● / ●	● / -	● / ●
	Power factor and cos φ (fundamental)	PF and cos φ, total and per phase	-	●	-	●
<b>Maximeters / minimeters</b>						
	Associated with instantaneous rms measurements	Reset via MicroLogic or FDM display unit	●	●	-	●
<b>Energy metering</b>						
Energy	Active (kWh), reactive (kvarh), apparent (kVAh)	Total since last reset Absolute or signed mode [1]	-	●	●	●
<b>Demand and maximum demand values</b>						
Demand current (A)	Phases and neutral	Present value on the selected window	-	●	-	●
		Maximum demand since last reset	-	●	-	●
Demand power	Active (kWh), reactive (kvarh), apparent (kVA)	Present value on the selected window	-	●	-	●
		Maximum demand since last reset	-	●	-	●
Calculation window	Sliding, fixed or com-synchronised	Adjustable from 5 to 60 minutes in 1 minute steps [2]	-	●	-	-
<b>Power quality</b>						
Total harmonic distortion (%)	Of voltage with respect to rms value	THDU, THDV of the Ph-Ph and Ph-N voltage	-	●	-	●
	Of current with respect to rms value	THDI of the phase current	-	●	-	●

[1] Absolute mode: E absolute = E out + E in; Signed mode: E signed = E out - E in.

[2] Available via the communication system only.

[3] FDM121 only.

[4] Two last I<sub>Δn</sub> and Δt values are available as well as date of setting.

### Additional technical characteristics

#### Measurement accuracy

Accuracies are those of the entire measurement system, including the sensors:

- current: Class 1 as per IEC 61557-12
- voltage: 0.5 %
- power and energy: Class 2 as per IEC 61557-12
- frequency: 0.1 %.



# ComPact NSX diagnostics & maintenance

## MicroLogic 5 / 6 / 7 A or E electronic trip units

B



MicroLogic built-in LCD display.

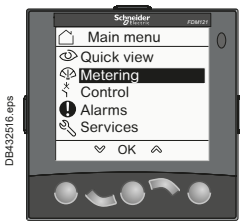

FDM121 display: navigation.

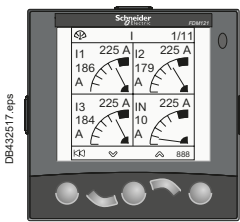

FDM121 display: current

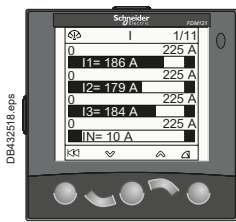

FDM121 display: voltage

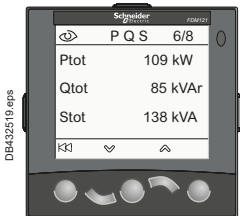

FDM121 display: power.

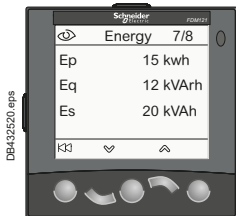

FDM121 display: consumption

Examples of operating-assistance screens on the FDM121 display unit.

### Personalised alarms with time-stamping

#### Alarm types

The user can assign an alarm to all MicroLogic A or E measurements or events:

- up to 12 alarms can be used together:
- two alarms are predefined and activated automatically:
  - MicroLogic 5: overload (Ir)
  - MicroLogic 6: overload (Ir) and ground fault (Ig)
  - MicroLogic Vigi 7 E: overload (Ir) and earth leakage fault (IΔn)
- thresholds, priorities and time delays can be set for ten other alarms.
- the same measurement can be used for different alarms to precisely monitor certain values, e.g. the frequency or the voltage
- alarms can also be assigned to various states: phase lead/lag, four quadrants, phase sequence
- selection of display priorities, with pop-up possibility
- alarm time-stamping.

#### Alarm settings

Alarms cannot be set via the keypad or the FDM display unit. They are set via communication with the PC. Set-up includes the threshold, priority, activation delay before display and deactivation delay. It is also possible to reprogram the standard assignment for the two SDx relay outputs to user-selected alarms.

#### Alarm reading

Remote alarm indications.

- Reading on FDM display unit or on PC via the communication system.
- Remote indications via SDx relay with two output contacts for alarms.

### Histories and event tables

MicroLogic A and E have histories and event tables that are always active.

#### Three types of time-stamped histories

- Tripping due to overruns of Ir, I<sub>sd</sub>, I<sub>l</sub>, Ig, IΔn: last 17 trips
- Alarms: last 10 alarms
- Operating events: last 10 events
- Each history record is stored with:
  - indications in clear text in a number of user-selectable languages
  - time-stamping: date and time of event
  - status: pick-up / drop-out

#### Two types of time-stamped event tables

- Protection settings.
- Minimizers / maximizers.

#### Display of alarms and tables

The time-stamped histories and event tables may be displayed on a PC via the communication system.

#### Embedded memory

MicroLogic A and E have a non-volatile memory that saves all data on alarms, histories, event tables, counters and maintenance indicators even if power is lost.

### Maintenance indicators

MicroLogic A and E have indicators for, among others, the number of operating cycles, contact wear and operating times (operating hours counter) of the ComPact NSX circuit breaker.

It is possible to assign an alarm to the operating cycle counter to plan maintenance. The various indicators can be used together with the trip histories to analyse the level of stresses the device has been subjected to.

The information provided by the indicators cannot be displayed on the MicroLogic LCD. It is displayed on the PC via the communication system.

### Management of installed devices

Each circuit breaker equipped with a MicroLogic 5 or 6 or 7 trip unit can be identified via the communication system:

- serial number
- firmware version
- hardware version
- device name assigned by the user.

This information together with the previously described indications provides a clear view of the installed devices.

# ComPact NSX diagnostics & maintenance

## MicroLogic 5 / 6 / 7 A or E electronic trip units



MicroLogic 5 / 6 / 7 operating assistance functions			Type		Display		
			A	E	MicroLogic LCD	FDM display	
<b>Operating assistance</b>							
<b>Personalised alarms</b>							
Settings	Up to 10 alarms assigned to all A and E measurements <sup>[2]</sup>		●	●	-	-	
	Phase lead/lag, four quadrants, phase sequence, display priority selection <sup>[2]</sup>		-	●	-	-	
Display	Alarms / tripping / test (Earth Leakage)		●	●	- / ● / ●	● / ● / ●	
Remote indications	Activation of two dedicated contacts on SDx module		●	●	-	-	
<b>Time-stamped histories (ms)</b>							
Trips (last 17)	Cause of tripping	Ir, lsd, li (MicroLogic 5, 6)	●	●	-	●	
		Ig (MicroLogic 6)	●	●	-	●	
		Ir, lsd, li, IΔn (MicroLogic Vigi 7 E)	-	●	-	●	
		Phase fault	●	●	-	●	
		Interrupted current value	●	●	-	●	
Alarms (last 10)		●	●	-	●		
Test Earth Leakage MicroLogic Vigi 7 E (last 10)		-	●	-	●		
Operating events (last 10)	Event types	Modification of protection setting by dial	-	●	-	●	
		Opening of keypad lock	-	●	-	●	
		Test via keypad	-	●	-	●	
		Test via external tool	-	●	-	●	
		Time setting (date and time)	-	●	-	●	
		Reset for maximeter/minimeter and energy meter	●	●	-	●	
Time stamping (date and time, text, status)		●	●	-	●		
<b>Time-stamped event tables</b>							
Protection settings	Setting modified (value displayed)	Ir, tr, lsd, tsd, li, Ig, tg <sup>[2]</sup>	●	●	-	-	
		Ir, tr, lsd, tsd, I, IΔn, Δt (MicroLogic Vigi 7 E) <sup>[2]</sup>	-	●	-	●	
	Time-stamping	Date and time of modification <sup>[2]</sup>	●	●	-	-	
	Previous value	Value before modification <sup>[2]</sup>	●	●	-	-	
Min/Max	Values monitored	I1, I2, I3, IN	●	●	-	●	
		U12, U23, U31, f	-	●	-	●	
	Time-stamping of each value	Date and time of min/max record	●	●	-	●	
	Current min/max value	Min/max value	●	●	-	●	
<b>Maintenance indicators</b>							
Counter	Mechanical cycles <sup>[1]</sup>	Assignable to an alarm	●	●	-	●	
		Electrical cycles <sup>[1]</sup>	●	●	-	●	
		Trips	One per type of trip <sup>[2]</sup>	●	●	-	-
		Alarms	One for each type of alarm <sup>[2]</sup>	●	●	-	-
		Hours	Total operating time (hours) <sup>[2]</sup>	●	●	-	-
Indicator	Contact wear	%	●	●	-	●	
Load profile	Hours at different load levels	% of hours in four current ranges: 0-49 % In, 50-79 % In, 80-89 % In and ≥ 90 % In	●	●	-	●	

[1] The BSCM module is required for these functions.

[2] Available via the communication system only.

### Additional technical characteristics

#### Contact wear

Each time ComPact NSX opens, the MicroLogic 5 / 6 / 7 trip unit measures the interrupted current and increments the contact-wear indicator as a function of the interrupted current, according to test results stored in memory. Breaking under normal load conditions results in a very slight increment. The indicator value may be read on the FDM121 display. It provides an estimation of contact wear calculated on the basis of the cumulative forces affecting the circuit breaker. When the indicator reaches 80 %, it is advised to replace the circuit breaker to ensure the availability of the protected equipment.

#### Circuit breaker load profile

MicroLogic 5 / 6 / 7 calculates the load profile of the circuit breaker protecting a load circuit. The profile indicates the percentage of the total operating time at four current levels (% of breaker In):

- 0 to 49 % In
- 50 to 79 % In
- 80 to 89 % In
- ≥ 90 % In. This information can be used to optimise use of the protected equipment or to plan ahead for extensions.



# ComPact NSX diagnostics & maintenance

## MicroLogic 5 / 6 / 7 A or E electronic trip units

Electrical power supply availability and reliability are the main critical issues affecting profitability and competitiveness. Outage management focuses on preventing, detecting, locating and clearing of faults.

B



PB1103365\_eps

MicroLogic built-in LCD display.

The MicroLogic 5 / 6 / 7 A or E control units perform in real time a high level of diagnostics on ComPact NSX circuit breakers. They generate and store appropriate warnings, alarms and messages to help the users with maintenance and power restoration.

This function complies with the following end user values:

- Prevent interruption of the power supply, to ensure continuity of operation, preserve the asset from any damage and supports the safety of persons,
- Reduce downtime resulting from an unexpected failure in the electrical distribution system, to be able to restart as quickly as possible after a trip,
- To keep the devices in good condition of operation.

### Prevention of power supply interruptions

Prevention of power supply interruptions is achieved by generation of warnings to the users, preventive operations of maintenance, and anticipation of device replacement.

By means of dedicated features, MicroLogic 5 / 6 / 7 A or E monitors the health of the circuit breaker and generates appropriate information to help the users in scheduling periodic checks and, if needed, anticipated replacement of devices.



# ComPact NSX special applications

## Protection of public distribution systems with MicroLogic 2-AB

MicroLogic AB trip units are used in public distribution systems to limit the current supplied according to the consumer's contract. They are available in 100, 160, 240 and 400 A ratings and are supplied with a lead-seal device to protect the settings.

ComPact NSX circuit breakers equipped with MicroLogic AB trip units are installed as incoming devices for consumer installations connected to the public LV distribution system.

With respect to the utility, they have two functions.

- Consumption is limited to the contractual power level. If the limit is exceeded, a fast thermal-protection function trips the device at the head of the consumer's installation without the utility having to intervene.
- Total selectivity is ensured with the upstream fuses on the public distribution system in the event of a fault, overload or short-circuit in the consumer's installation, protecting the utility line.

In addition, they provide the consumer with:

- protection for the installation as a whole, with the possibility of adding a Vigi earth-leakage protection module
- the possibility of downstream selectivity.

This type of ComPact NSX is often used in conjunction with an ComPact INV switch-disconnector located outside the consumer's building and providing the visible-break function.

This means the operator can directly see, through a transparent cover, the physical separation of the main contacts. The ComPact INV range is also suitable for isolation with positive contact indication.

This means utility operators can work on the service-connection unit after isolating it from the upstream line.

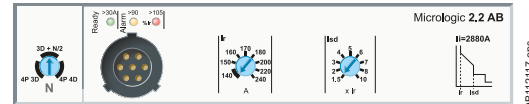

ComPact NSX with MicroLogic 2 AB.

DB112117.eps

PB118117.eps

B

# ComPact NSX special applications

## Protection of public distribution systems with MicroLogic 2-AB

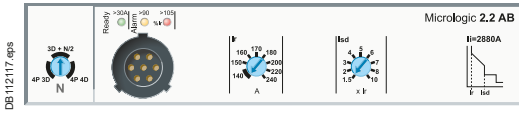

DB112117.eps

B

### Protection

Settings are made using the adjustment dials with fine-adjustment possibilities and a lead-seal fixture.

#### Overloads: Long-time protection (Ir)

Inverse-time thermal protection against overloads with an adjustable current pick-up  $I_r$  and a very short, non-adjustable time delay  $t_r$  (15 seconds for  $1.5 \times I_r$ ).

#### Short-circuits: Short-time protection (I<sub>sd</sub>) with fixed time delay

Short-circuit protection with an adjustable pick-up  $I_{sd}$ . The short-time pick-up values are high enough to avoid nuisance tripping in the event of transient current spikes.

#### Short-circuits: Non-adjustable instantaneous protection

Instantaneous short-circuit protection with a fixed pick-up.

#### Neutral protection

Available on four-pole circuit breakers only. Neutral protection may be set using a three-position switch:

- 4P 3D: neutral unprotected
- 4P 3D + N/2: neutral protection at half the value of the phase pick-up, i.e.  $0.5 \times I_r$
- 4P 4D: neutral fully protected at  $I_r$ .

### Indications

#### Front indications

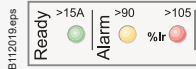

DB112019.eps

- Green "Ready" LED: flashes slowly when the circuit breaker is ready to trip in the event of a fault.
- Orange overload pre-alarm LED: steady on when  $I > 90 \% I_r$ .
- Red overload LED: steady on when  $I > 105 \% I_r$ .

#### Remote indications

An SDx relay module installed inside the circuit breaker can be used to remote the overload-trip signal. This module receives the signal from the MicroLogic electronic trip unit via an optical link and makes it available on the terminal block. The signal is cleared when the circuit breaker is closed.

The module is described in detail in the section dealing with accessories [page C-31](#).



PB103377.eps

SDx remote indication relay module with its terminal block.

# ComPact NSX special applications

## Protection of public distribution systems with MicroLogic 2-AB

B

### MicroLogic 2.2 / 2.3 AB

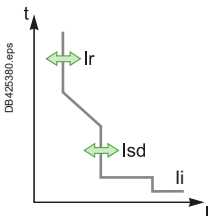

Ratings (A)	In at 40 °C <sup>(1)</sup>	100	160	240	400
Circuit breaker	ComPact NSX100	●	-	-	-
	ComPact NSX160	●	●	-	-
	ComPact NSX250	●	●	●	-
	ComPact NSX400	-	-	-	●
	ComPact NSX630	-	-	-	●

L Long-time protection		value depending on trip unit rating (In) and setting on dial											
Pick-up (A) tripping between 1.05 and 1.20 Ir	Ir	In = 100 A	Ir = 40	40	50	60	70	80	90	100			
		In = 160 A	Ir = 90	100	110	120	130	140	150	160			
		In = 240 A	Ir = 140	150	160	170	180	200	220	240			
		In = 400 A	Ir = 260	280	300	320	340	360	380	400			
Time delay (s)	tr		non-adjustable										
			1.5 Ir	15									
			6 Ir	0.5									
			7.2 Ir	0.35									
Thermal memory			20 minutes before and after tripping										

S <sub>n</sub> Short-time protection with fixed time delay		value depending on trip unit rating (In) and setting on dial									
Pick-up (A) accuracy ±10 %	Isd = Ir x ...	1.5	2	3	4	5	6	7	8	10	
Time delay (ms)	tsd	non-adjustable: 20									
	Non-tripping time	20									
	Maximum break time	80									

I Non-adjustable instantaneous protection		value depending on trip unit rating (In) and setting on dial									
Pick-up (A) accuracy ±15 %	Ii non-adjustable	1500	1600	2880	4800						
Time delay (ms)	Non-tripping time	10									
	Maximum break time	50									

[1] If the trip units are used in high-temperature environments, the MicroLogic setting must take into account the thermal limitations of the circuit breaker. See the temperature derating table.

### Technical details

#### Advantages of the AB trip unit

- Controls the power drawn with respect to contractual power levels. If the contractual level is overrun, the circuit breaker opens and the consumer is not billed excess costs.
- If a short-circuit occurs, the circuit breaker opens and the upstream HRC fuses on utility lines are not affected. No expensive utility servicing is billed to the consumer.

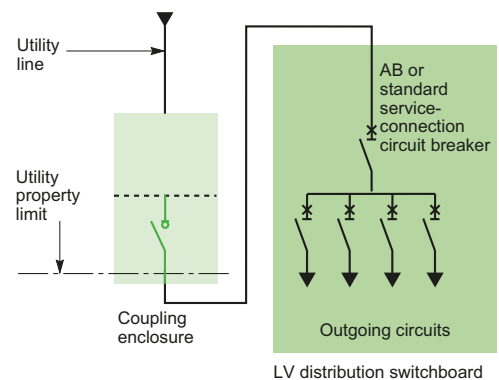

Consumer connection diagram.

# ComPact NSX special applications

## ComPact NSX MicroLogic Vigi 4-AB trip unit with embedded earth leakage protection

The ComPact NSX range for public distribution is now complemented with a new type of MicroLogic AB trip unit including both circuit protection and earth leakage protection. It means that the earth leakage protection, previously located within the Vigi Add-on, will be embedded within the existing size of the MicroLogic AB trip unit.

B

LV43817.eps

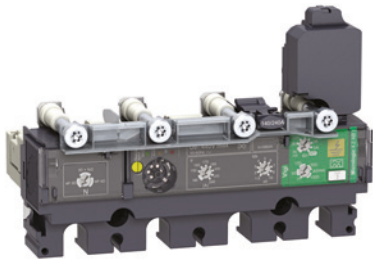

MicroLogic Vigi 4.2-AB trip unit.

### MicroLogic Vigi 4-AB

ComPact ELCB<sup>19</sup> equipped with that "new" earth leakage trip unit MicroLogic AB are installed as an incoming device for installation connected with the public LV distribution system. With respect to the utility requirement, it ensures the same functions as the standard circuit breaker: limitation of consumption, selectivity upstream and downstream, combination with ComPact INV to ensure the visible break or positive contact indication.

### Short circuit and overload protections

Settings are made using the rotary dial with fine adjustment capabilities and lead-seal fixture.

#### Overload: long-time protection ( $I_r$ )

Inverse time protection against overload with an adjustable current pick-up  $I_r$  set using a dial and a very short non adjustable time delay  $t_r$  (15 seconds at 1.5  $I_r$ ).

#### Short-circuit: short-time protection with fixed time delay ( $I_{sd}$ )

That protection is set with an adjustable pick-up  $I_{sd}$ . The short time pick-up values are high enough to avoid nuisance tripping in the event of transient current spikes.

#### Short circuit: non-adjustable instantaneous protection (with a fix pick-up)

#### Neutral protection

Available on four-pole ComPact NSX MicroLogic Vigi 4-AB only, the neutral protection may be set using the dedicated coding wheel to meet the following configurations: 4P 3D, 4P 3D + N/2 or 4P 4D. (same as for the MicroLogic 2-AB)

### Earth leakage protections

Adjustable leakage threshold ( $I_{\Delta n}$ ) and adjustable time threshold ( $\Delta t$ ) by using the two dials on the green area of the trip unit.

The ComPact NSX MicroLogic Vigi 4-AB, embedding a MicroLogic AB can only be "Trip" type, the "Alarm" version (as for MicroLogic Vigi 4 and 7 E) doesn't exist.

#### Power supply

The trip unit is self supplied, and so does not need any external source. It works even when fed by 2 phases only!

#### Sensitivity $I_{\Delta n}$ (A)

- Type A: 30mA - 100mA - 300mA - 500mA - 1A - 3A - 5A (for the ratings 100 to 240A)
- Type A: 300mA - 500mA - 1A - 3A - 5A - 10A (for the rating 400A)

**Caution:** "OFF" setting of  $I_{\Delta n}$  is possible, it cancels the earth leakage protection, in that case, the ComPact NSX MicroLogic Vigi 4-AB behaves as an standard circuit breaker. "OFF" position is located on the highest side of the coding wheel.

#### Intentional delay $\Delta t$ (s)

Case  $I_{\Delta n} = 30\text{mA}$ : 0 sec (whatever the setting)

Case  $I_{\Delta n} > 30\text{mA}$ : 0 - 60ms - 150ms - 500ms - 1sec (by setting)

#### Operated voltage

200 to 440 VAC (only) - 50/60 Hz

#### Operating safety

The earth leakage protection is a user safety device. It must be regularly tested using the test button (T) that simulates a real current leakage within the toroid.

When  $I_{\Delta n}$  is set on the OFF position, press the T will cancel any test.

As for standard circuit breaker, the circuit breaker with MicroLogic Vigi 4-AB can be reset after any fault by operating an OFF/ON procedure.

# ComPact NSX special applications

## ComPact NSX MicroLogic Vigi 4-AB trip unit with embedded earth leakage protection

### Indications

#### Front indications

- Green "Ready" LED: flashes slowly when the circuit breaker is ready to trip in case of a fault.
- Orange overload pre-alarm LED: steady ON when  $I > 90\% I_r$ .
- Red overload LED: steady ON when  $I > 105\% I_r$ .
- Yellow Screen: indicates an earth leakage fault (reset when the device is operated OFF/ON).

#### Alarming and fault differentiation

- An overload trip signal can be remotely available by installing an SDx relay module inside the circuit breaker.
- An earth leakage pre-alarm can be remotely available by installing an SDx module, only on the ComPact NSX MicroLogic Vigi 4-AB. This module receives the signal from the MicroLogic electronic trip unit via an optical link and makes it available on the terminal block. The signal is reset when the breaker is operated.

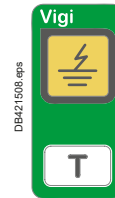

### MicroLogic Vigi 4-AB (earth leakage "Trip" version only)

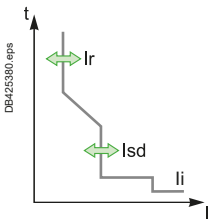

Ratings (A)	In at 40 °C [1]	100	160	240	400
Circuit breaker	ComPact NSX100	●			
	ComPact NSX160	●	●		
	ComPact NSX250	●	●	●	
	ComPact NSX400				●
	ComPact NSX630				●

L Long-time protection																																													
Pick-up (A)	$I_r$ value depending on the rating ( $I_n$ ) and the dial setting (9 positions)																																												
tripping between 1.05 and 1.20 $I_r$	<table border="1"> <tr> <td><math>I_n = 100</math> A</td> <td><math>I_o =</math></td> <td>40</td> <td>40</td> <td>40</td> <td>50</td> <td>60</td> <td>70</td> <td>80</td> <td>90</td> <td>100</td> </tr> <tr> <td><math>I_n = 160</math> A</td> <td><math>I_o =</math></td> <td>90</td> <td>90</td> <td>100</td> <td>110</td> <td>120</td> <td>130</td> <td>140</td> <td>150</td> <td>160</td> </tr> <tr> <td><math>I_n = 240</math> A</td> <td><math>I_o =</math></td> <td>140</td> <td>140</td> <td>150</td> <td>160</td> <td>170</td> <td>180</td> <td>200</td> <td>220</td> <td>240</td> </tr> <tr> <td><math>I_n = 400</math> A</td> <td><math>I_o =</math></td> <td>260</td> <td>260</td> <td>280</td> <td>300</td> <td>320</td> <td>340</td> <td>360</td> <td>380</td> <td>400</td> </tr> </table>	$I_n = 100$ A	$I_o =$	40	40	40	50	60	70	80	90	100	$I_n = 160$ A	$I_o =$	90	90	100	110	120	130	140	150	160	$I_n = 240$ A	$I_o =$	140	140	150	160	170	180	200	220	240	$I_n = 400$ A	$I_o =$	260	260	280	300	320	340	360	380	400
$I_n = 100$ A	$I_o =$	40	40	40	50	60	70	80	90	100																																			
$I_n = 160$ A	$I_o =$	90	90	100	110	120	130	140	150	160																																			
$I_n = 240$ A	$I_o =$	140	140	150	160	170	180	200	220	240																																			
$I_n = 400$ A	$I_o =$	260	260	280	300	320	340	360	380	400																																			
Time delay (s)	$t_r$ non-adjustable																																												
accuracy 0 to -20%	<table border="1"> <tr> <td>at</td> <td><math>1.5 \times I_r</math></td> <td><math>t_r = 15</math> s</td> </tr> <tr> <td>at</td> <td><math>6 \times I_r</math></td> <td><math>t_r = 0.5</math> s</td> </tr> <tr> <td>at</td> <td><math>7.2 \times I_r</math></td> <td><math>t_r = 0.35</math> s</td> </tr> </table>	at	$1.5 \times I_r$	$t_r = 15$ s	at	$6 \times I_r$	$t_r = 0.5$ s	at	$7.2 \times I_r$	$t_r = 0.35$ s																																			
at	$1.5 \times I_r$	$t_r = 15$ s																																											
at	$6 \times I_r$	$t_r = 0.5$ s																																											
at	$7.2 \times I_r$	$t_r = 0.35$ s																																											
Thermal memory	20 minutes before and after tripping																																												

S <sub>0</sub> Short-time protection with fixed time delay	
Pick-up (A)	$I_{sd} = I_r \times \dots$
accuracy ±10 %	1.5 2 3 4 5 6 7 8 10
Time delay (ms)	$t_{sd}$ non-adjustable
	Non-tripping time 20
	Maximum break time 80

I Instantaneous protection	
Pick-up (A)	$I_i$ non-adjustable
accuracy ±15 %	1500 1600 2880 4800
	Non-tripping time 10 ms
	Maximum break time 50 ms

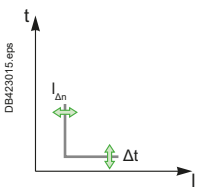

R Earth leakage protection																																													
Sensitivity (A)	Type A, adjustable (9 positions)																																												
	<table border="1"> <tr> <td><math>I_n = 100</math> A</td> <td><math>I_{\Delta n} =</math></td> <td>0.03</td> <td>0.03</td> <td>0.1</td> <td>0.3</td> <td>0.5</td> <td>1</td> <td>3</td> <td>5</td> <td>OFF</td> </tr> <tr> <td><math>I_n = 160</math> A</td> <td><math>I_{\Delta n} =</math></td> <td>0.03</td> <td>0.03</td> <td>0.1</td> <td>0.3</td> <td>0.5</td> <td>1</td> <td>3</td> <td>5</td> <td>OFF</td> </tr> <tr> <td><math>I_n = 240</math> A</td> <td><math>I_{\Delta n} =</math></td> <td>0.03</td> <td>0.03</td> <td>0.1</td> <td>0.3</td> <td>0.5</td> <td>1</td> <td>3</td> <td>5</td> <td>OFF</td> </tr> <tr> <td><math>I_n = 400</math> A</td> <td><math>I_{\Delta n} =</math></td> <td>0.3</td> <td>0.3</td> <td>0.5</td> <td>1</td> <td>3</td> <td>5</td> <td>10</td> <td>10</td> <td>OFF</td> </tr> </table>	$I_n = 100$ A	$I_{\Delta n} =$	0.03	0.03	0.1	0.3	0.5	1	3	5	OFF	$I_n = 160$ A	$I_{\Delta n} =$	0.03	0.03	0.1	0.3	0.5	1	3	5	OFF	$I_n = 240$ A	$I_{\Delta n} =$	0.03	0.03	0.1	0.3	0.5	1	3	5	OFF	$I_n = 400$ A	$I_{\Delta n} =$	0.3	0.3	0.5	1	3	5	10	10	OFF
$I_n = 100$ A	$I_{\Delta n} =$	0.03	0.03	0.1	0.3	0.5	1	3	5	OFF																																			
$I_n = 160$ A	$I_{\Delta n} =$	0.03	0.03	0.1	0.3	0.5	1	3	5	OFF																																			
$I_n = 240$ A	$I_{\Delta n} =$	0.03	0.03	0.1	0.3	0.5	1	3	5	OFF																																			
$I_n = 400$ A	$I_{\Delta n} =$	0.3	0.3	0.5	1	3	5	10	10	OFF																																			
Time delay $\Delta t$ (ms)	Adjustable $\Delta t =$																																												
	<table border="1"> <tr> <td>0</td> <td>60 [2]</td> <td>150 [2]</td> <td>500 [2]</td> <td>1000 [2]</td> </tr> </table>	0	60 [2]	150 [2]	500 [2]	1000 [2]																																							
0	60 [2]	150 [2]	500 [2]	1000 [2]																																									
	Maximum break time (ms)																																												
	<table border="1"> <tr> <td>&lt;40</td> <td>&lt;140</td> <td>&lt;300</td> <td>&lt;800</td> <td>&lt;1500</td> </tr> </table>	<40	<140	<300	<800	<1500																																							
<40	<140	<300	<800	<1500																																									

[1] For the use in high temperature environment, take into account the thermal limitation of the breaker.  
 [2] The time delay ( $\Delta t$ ) is mandatory and designed " $\Delta t = 0$ " when the  $I_{\Delta n}$  dial is set on 30mA (0.03). The time delay has no effect when the dial  $I_{\Delta n}$  is set to the "OFF" position.

# ComPact NSX special applications

## Generator protection with MicroLogic 2.2 G

MicroLogic G trip units are used for the protection of systems supplied by generators or comprising long cable lengths. They can be mounted on all ComPact NSX100/160/250 circuit breakers. With extensive setting possibilities, MicroLogic 5 offers the same functions from 100 to 630 A. A thermal-magnetic trip unit is also available for the NSX100 to 250 (see page B-6).

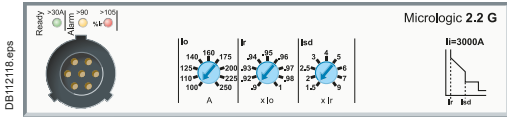

B

Circuit breakers equipped with MicroLogic G trip units protect systems supplied by generators (lower short-circuit currents than with transformers) and distribution systems with long cable lengths (fault currents limited by the resistance of the cable).

### Protection

Settings are made using the adjustment dials with fine adjustment possibilities.

#### Overloads: Long-time protection (I<sub>r</sub>)

Inverse-time thermal protection against overloads with an adjustable current pick-up I<sub>r</sub> and a very short, non-adjustable time delay **tr** (15 seconds for 1.5 x I<sub>r</sub>).

#### Short-circuits: Short-time protection (I<sub>sd</sub>) with fixed time delay

Short-circuit protection with an adjustable pick-up I<sub>sd</sub>, delayed 200 ms, in compliance with the requirements of marine classification companies.

#### Short-circuits: Non-adjustable instantaneous protection (I<sub>i</sub>)

Instantaneous short-circuit protection with a fixed pick-up required for generator protection.

#### Neutral protection

- On 3-pole circuit breakers, neutral protection is not possible.
- On four-pole circuit breakers, neutral protection may be set using a three-position switch:
  - 4P 3D: neutral unprotected
  - 4P 3D + N/2: neutral protection at half the value of the phase pick-up, i.e. 0.5 x I<sub>r</sub>
  - 4P 4D: neutral fully protected at I<sub>r</sub>.

### Indications

#### Front indications

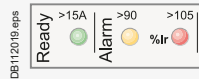

- Green "Ready" LED: flashes slowly when the circuit breaker is ready to trip in the event of a fault.
- Orange overload pre-alarm LED: steady on when I > 90 % I<sub>r</sub>.
- Red overload LED: steady on when I > 105 % I<sub>r</sub>.

#### Remote indications

An SDx relay module installed inside the circuit breaker can be used to remote the overload-trip signal.

This module receives the signal from the MicroLogic electronic trip unit via an optical link and makes it available on the terminal block. The signal is cleared when the circuit breaker is closed.

The module is described in detail in the section dealing with accessories.



SDx remote indication relay module with its terminal block.

# ComPact NSX special applications

## Generator protection with MicroLogic 2.2 G



### MicroLogic 2.2 G

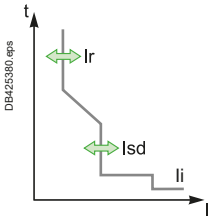

Ratings (A)	In at 40 °C [1]	40	100	160	250
Circuit breaker	ComPact NSX100	<input checked="" type="radio"/>	<input checked="" type="radio"/>	-	-
	ComPact NSX160	<input checked="" type="radio"/>	<input checked="" type="radio"/>	<input checked="" type="radio"/>	-
	ComPact NSX250	<input checked="" type="radio"/>	<input checked="" type="radio"/>	<input checked="" type="radio"/>	<input checked="" type="radio"/>

### L Long-time protection

Pick-up (A) tripping between 1.05 and 1.20 Ir	<b>Io</b>	value depending on trip unit rating (In) and setting on dial								
In = 40 A	Io =	18	18	20	23	25	28	32	36	40
In = 100 A	Io =	40	45	50	55	63	70	80	90	100
In = 160 A	Io =	63	70	80	90	100	110	125	150	160
In = 250 A (NSX250)	Io =	100	110	125	140	150	176	200	225	250

**Ir = Io** 9 fine-adjustment settings from 0.9 to 1 for each Io value x ...

Time delay (s) accuracy 0 to -20 %	<b>tr</b>	non-adjustable
	1.5 x Ir	15
	6 x Ir	0.5
	7.2 x Ir	0.35

Thermal memory 20 minutes before and after tripping

### S<sub>0</sub> Short-time protection with fixed time delay

Pick-up (A) accuracy ±10 %	<b>Isd = Ir x ...</b>	1.5	2	2.5	3	4	5	6	7	8	9
Time delay (ms)	<b>tsd</b>	non-adjustable									
	Non-tripping time	140									
	Maximum break time	200									

### I Non-adjustable instantaneous protection

Pick-up (A) accuracy ±15 %	<b>Ii non-adjustable</b>	600	1500	2400	3000
	Non-tripping time	15 ms			
	Maximum break time	50 ms			

[1] If the trip units are used in high-temperature environments, the MicroLogic setting must take into account the thermal limitations of the circuit breaker. See the temperature derating table.

# ComPact NSX special applications

## Protection of industrial control panels

ComPact NSX circuit breakers are also used in industrial control panels.

They serve as an incoming devices or can be combined with contactors to protect motor feeders:

- compliance with worldwide standards including IEC 60947-2 and UL 508 / CSA 22-2 no. 14
- overload and short-circuit protection
- isolation with positive contact indication, making it possible to service machines safely by isolating them from all power sources
- installation in universal and functional type enclosures
- NA switch-disconnector version.

B

DB417468.eps

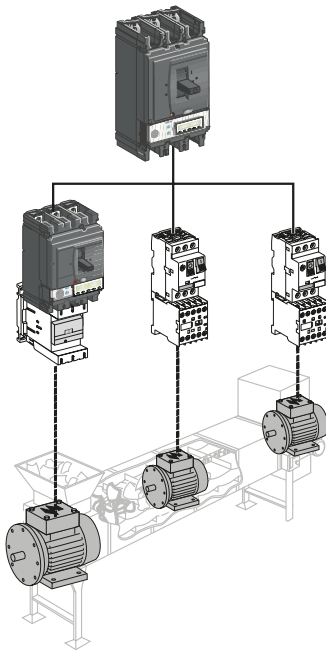

DB110234.eps



### Industrial control panels

ComPact NSX circuit breakers equipped for public distribution or motor protection functions as described in the previous pages can be used in industrial control panels. The accessories for the ComPact NSX range are suitable for the special needs of these switchboards.

### Auxiliaries

All auxiliaries can be added to the circuit breaker by the user:

- padlocking devices (in the OFF position)
- rotary handle
- status-indication auxiliary contacts (ON, OFF and tripped)
- shunt (MX) or undervoltage (MN) releases
- early-make or early-break contacts.

### Rotary handle

Direct or extended versions for mounting up to 600 mm behind the front:

- black front with black handle
- yellow front with red handle (for machine tools or emergency off as per IEC 204 / VDE 0013).

All rotary handles can be padlocked in the OFF position. Optional door interlock, recommended for MCC panels (motor control centres).

When the device is equipped with an extended rotary handle, a control accessory mounted on the shaft makes it possible to operate the device with the door open. The device can be padlocked in the OFF position in compliance with UL508.

### Early-make or early-break contacts

These contacts can be used respectively to supply an MN undervoltage release before the circuit breaker closes or to open the contactor control circuit before the circuit breaker opens.

### Special functions

- Indication of thermal overloads with the SDx module.
- Early opening of the contactor for overload faults with the SDTAM module.
- Links with PLCs via the communication system.
- Measurement of all electrical parameters with MicroLogic A and E.
- Programmable alarms with MicroLogic 5 and 6.

### Installation in enclosures

ComPact circuit breakers can be installed in a metal enclosure together with other devices (contactors, motor-protection circuit breakers, LEDs, etc.).



## ComPact NSX special applications

## Protection of industrial control panels

## Compliance with North American industrial control equipment standards

ComPact NSX devices have received UL508 / CSA 22-2 no. 14 approval for industrial control equipment of the "Manual Motor Controller", "Across the Line Starter", "General Use" and "Disconnecting Means" types.

Type NA devices are switch-disconnectors that must always be protected upstream.

### UL508 approval

Circuit breakers	Trip units	Approvals
ComPact NSX100 to 630 F/N/H	TMD, MicroLogic 2, 5 and 6	General Use Motor Disconnecting Means
	NA, MA, MicroLogic 1.3 M, 2.2 M, 2.3 M, MicroLogic 6.2 E-M and 6.3 E-M	Manual Motor Controller Across the Line Starter Motor Disconnecting Means

Table of 3-phase motor ratings in hp (1 hp = 0.7457 kW)

V AC ratings		115	230	460	575
<b>TMD MicroLogic 2, 5 and 6</b>	<b>NA, MA MicroLogic 1.3 M, 2.2 M, 2.3 M MicroLogic 6.2 E-M and 6.3 E-M</b>				
25	25	3	7.5	15	20
50	50	7.5	15	30	40
100	100	15	30	75	100
160	150	25	50	100	150
250	220	40	75	150	200
400	320	-	125	250	300
550	500	-	150	350	500

The deratings indicated on pages E-14 to E-17 apply to TMD, MicroLogic 2, 5 and 6 trip units, rated at 40 °C.

# ComPact NSX special applications

## 16 Hz 2/3 network protection - MicroLogic 5 A-Z trip unit

ComPact NSX circuit breakers may be used on 16 Hz 2/3 systems with special thermal-magnetic and electronic (MicroLogic 5 A-Z) trip units.

B

### 16 Hz 2/3 networks

Single-phase distribution networks with a frequency of 16 Hz 2/3 are used for railroad applications in certain European countries.

### Breaking capacity for 16 Hz 2/3 at 250/500 V

ComPact NSX circuit breakers of the 3P 2D or the 3P 3D type protect 16 Hz 2/3 networks at 250 V or 500 V.

They can be equipped with either:

- a TM-D thermal-magnetic trip unit for ComPact NSX100 to 250
- or an electronic MicroLogic 5.2 A-Z trip unit for ComPact NSX100 to 250 or a 5.3 A-Z for ComPact NSX400/630.

The possible breaking-capacity performance levels are B, F, N and H as indicated below.

#### Breaking capacity I<sub>cu</sub>

Operating voltage	Performance	TMD and MicroLogic 5 A-Z trip units			
		B	F	N	H
250 V / 500 V	I <sub>cu</sub> (kA)	25	36	50	70

### Protection

#### TM-D thermal-magnetic trip units

The 16 Hz 2/3 frequency does not modify the thermal settings with respect to those at 50 Hz (see page B-6). The magnetic pick-ups are modified as shown below.

#### Magnetic protection for ComPact NSX 100/160/250 at 50 Hz and at 16 Hz 2/3

Rating (A) I <sub>n</sub> at 40 °C	16	25	32	40	50	63	80	100	125	160	200	250
Pick-up (A) I <sub>m</sub> accur. ±20%	Fixed											Adjustable
NSX100 50Hz	190	300	400	500	500	500	640	800				
16 Hz 2/3	170	270	360	450	450	450	580	720				
NSX160/250 50Hz	190	300	400	500	500	500	640	800	1250	1250		
16 Hz 2/3	170	270	360	450	450	450	580	720	1100	1100	4.5 to 9 I <sub>n</sub>	

#### MicroLogic 5 A-Z trip units

MicroLogic 5.2 A-Z and 5.3 A-Z are dedicated to 16 Hz 2/3 networks.

They use a suitable sampling frequency. The protection settings are identical to those of MicroLogic 5 A (see page B-12). They also offer a current-measurement function for this specific frequency.

### Trip-unit selection

Rating	16	63	100	160	250	400	630
ComPact NSX100	TM-D						
NSX160		TM-D					
NSX250				TM-D			
NSX100 to 250			MicroLogic 5.2 A-Z				
NSX400/630						MicroLogic 5.3 A-Z	

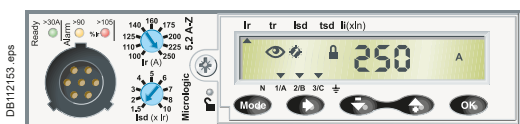
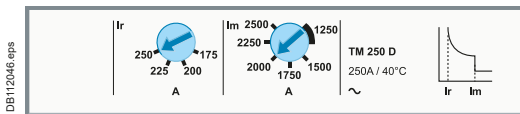

### Wiring for NSX100 to 630 A

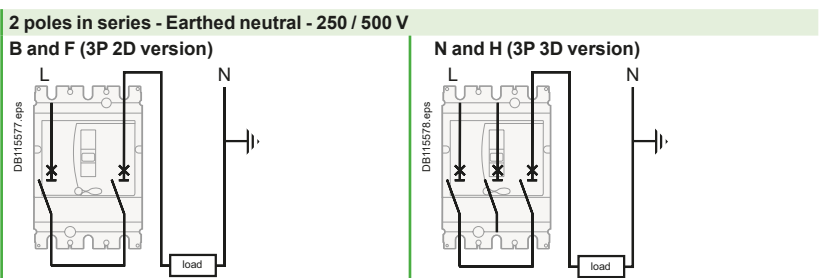
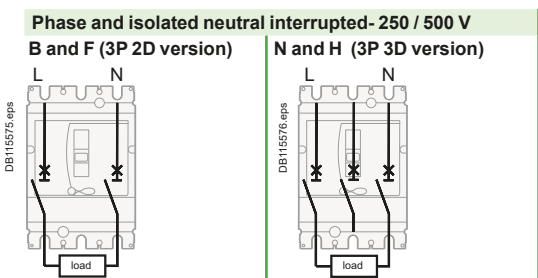

Remark. For an operating voltage > 250 V, the installation must be designed to eliminate all risk of double earth faults.

# ComPact NSXm special applications

## Protection of 400 Hz systems

ComPact NSXm circuit breakers may be used on 400 Hz systems.

### Breaking capacity in 400 Hz, 440 V Systems

The power levels of 400 Hz applications rarely exceed a few hundred kW with relatively low short circuit current, generally not exceeding four times the rated current.

Circuit breaker	Max. Breaking Capacity at 400 Hz
NSXm	10 kA

### Thermal-Magnetic Trip Units

Thermal-Magnetic trip units require the current rating (In) to be derated and the magnetic trip setting (Im) to be increased.

### Current Rating (In) and Magnetic Trip Setting (Im) Rerating

Circuit breaker	Maximum setting Coefficient	Max Ir setting at 400 Hz	Magnetic Im coefficient at 400 Hz
NSXm	0.9	144	1.6

### Shunt Trip (MX) or Undervoltage Trip (MN) Voltage Release at 400 Hz and 440V

Undervoltage releases (MN) rated 24 V AC/DC, 48 V AC/DC, or 110/130 V AC/DC are 400 Hz compliant with their nominal voltages. For voltages greater than 110/130 V AC/DC, please contact Schneider Electric for additional information. Shunt Trips (MX), please contact Schneider Electric.



ComPact NSXm TM-D.

PB114894\_L=41.eps



# ComPact NSX special applications

## Protection of 400 Hz systems

ComPact NSX circuit breakers may be used on 400 Hz systems.

B

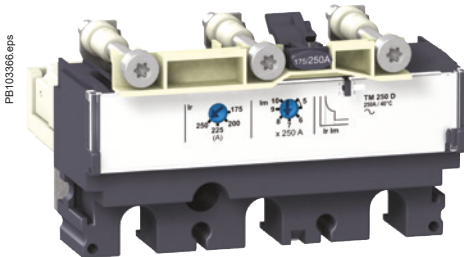

MicroLogic TM-D trip unit.

### 400 Hz distribution systems

The main 400 Hz applications are in aeronautics and certain military ships. Modern aircraft have three-phase 115/200 V 400 Hz networks.

### Impact on protective devices

Due to the higher frequency, circuit breakers are subjected to additional temperature rise for identical current levels, resulting from higher losses caused by Foucault currents and an increase in the skin effect (reduction in the useful CSA of conductors). To remain within the rated temperature-rise limits of devices, current derating is required.

The power levels of 400 Hz applications rarely exceed a few hundred kW with relatively low short-circuit currents, generally not exceeding four times the rated current.

The standard ComPact NSX range is suitable for 400 Hz applications if derating coefficients are applied to the protection settings. See the derating table below.

### Breaking capacity of ComPact NSX circuit breakers in 400 Hz, 440 V systems

Circuit breaker	Breaking capacity Icu
NSX100	10 kA
NSX160	10 kA
NSX250	10 kA
NSX400	10 kA
NSX630	10 kA

### Trip units equipped with thermal-magnetic protection

The 400 Hz current settings are obtained by multiplying the 50 Hz values by the following adaptation coefficient:

- K1 for thermal trip units
- K2 for magnetic trip units.

These coefficients are independent of the trip-unit setting.

#### Thermal trip units

The current settings are lower at 400 Hz than at 50 Hz ( $K1 < 1$ ).

#### Magnetic trip units

The current settings are conversely higher at 400 Hz than at 50 Hz ( $K2 > 1$ ). Consequently, when the trip units are adjustable, they must be set to the minimum value.

#### Adaptation coefficients for thermal-magnetic trip units

Circuit breaker	Trip unit	In (A) 50Hz	Thermal at 40°C		Im (A) 50Hz	Magnetic	
			K1	400 Hz		K2	400 Hz
NSX100	TM16G	16	0.95	15	63	1.6	100
	TM25G	25	0.95	24	80	1.6	130
	TM40G	40	0.95	38	80	1.6	130
	TM63G	63	0.95	60	125	1.6	200
NSX100	TM16D	16	0.95	15	240	1.6	300
	TM25D	25	0.95	24	300	1.6	480
	TM40D	40	0.95	38	500	1.6	800
	TM63D	63	0.95	60	500	1.6	800
	TM80D	80	0.9	72	650	1.6	1040
	TM100D	100	0.9	90	800	1.6	1280
	TM125D	125	0.9	112.5	1250	1.6	2000
NSX160	TM80D	80	0.9	72	650	1.6	1040
	TM100D	100	0.9	90	800	1.6	1280
	TM125D	125	0.9	112.5	1250	1.6	2000
	TM160D	160	0.9	144	1250	1.6	2000
NSX250	TM100D	100	0.9	90	800	1.6	1280
	TM160D	160	0.9	144	1250	1.6	2000
	TM200D	200	0.9	180	1000 to 2000	1.6	1600 to 3200
	TM250D	250	0.9	225	1250 to 2500	1.6	2000 to 4000

#### Example

NSX100 equipped with a TM16G with 50 Hz settings  $I_r = 16$  A and  $I_m = 63$  A. 400 Hz settings  $I_r = 16 \times 0.95 = 15$  A and  $I_m = 63 \times 1.6 = 100$  A.

# ComPact NSX special applications

## Protection of 400 Hz systems

### Protection

#### MicroLogic electronic trip units

MicroLogic 2.2, 2.3 or 5.2, 5.3 with A or E measurement functions are suitable for 400 Hz. The use of electronics offers the advantage of greater operating stability when the frequency varies. However the units are still subject to temperature rise caused by the frequency.

The practical consequences are:

- limit settings: see the I<sub>r</sub> derating table below
- the long-time, short-time and instantaneous pick-ups are not modified (see page B-10 or page B-12)
- the accuracy of the displayed measurements is 2 % (class II).

#### Thermal derating: maximum I<sub>r</sub> setting

Circuit breaker	Maximum setting coefficient	Max. I <sub>r</sub> setting at 400 Hz
NSX100	1	100
NSX250	0.9	200
NSX400	0.8	320
NSX630	0.63	400

#### Example

An NSX250N, equipped with a MicroLogic 2.2, I<sub>r</sub> = 250 A at 50 Hz, must be limited to use at I<sub>r</sub> = 250 x 0.9 = 225 A.

Its short-time pick-up with fixed time delay is adjustable from 1.5 to 10 I<sub>r</sub> (337.5 to 2250 A).

The instantaneous pick-up remains at 3000 A.

### OF auxiliary contacts in 400 Hz networks

#### Electrical characteristics of auxiliary contacts

Contacts	Standard		Low level	
	AC12	AC15	AC12	AC15
Utilisation cat. (IEC 60947-5-1)	AC12	AC15	AC12	AC15
Operational current (A)	24 V	6	5	3
	48 V	6	5	3
	110 V	6	5	2.5
	220/240 V	6	4	2
	380/415 V	6	2	1.5

### MN and MX voltage releases for ComPact NSX100/630 at 400 Hz and 440 V

For circuit breakers on 400 Hz systems, only 125 V DC MN or MX releases may be used. The release must be supplied by the 400 Hz system via a rectifier bridge (to be selected from the table below) and an additional resistor with characteristics depending on the system voltage.

U (V) 400 Hz	Rectifier	Additional resistor
220/240 V	Thomson 110 BHz or General Instrument W06 or Semikron SKB at 1.2/1.3	4.2 kΩ-5 W
380/420 V	Semikron SKB at 1.2/1.3	10.7 kΩ-10 W

Note: other models of rectifier bridges may be used if their characteristics are at least equivalent to those stated above.

### SDx indication contacts

The SDx module may be used in 400 Hz systems for voltages from 24 to 440 V. An SDx relay module installed inside the circuit breaker can be used to remote the overload-trip signal.

This module receives the signal from the MicroLogic electronic trip unit via an optical link and makes it available on the terminal block. The signal is cleared when the circuit breaker is closed.

These outputs can be reprogrammed to be assigned to other types of tripping or alarm (see page C-31).



MicroLogic 5 E trip unit.

PB103863.eps



OF auxiliary contact.

DB12547.eps



MX or MN voltage release.

044313\_20\_SE.eps

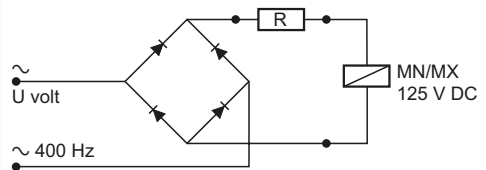

Wiring diagram.

DB115579.eps



SDx remote indication relay module with its terminal block.

PB103377.eps





# Customize your circuit breaker with accessories

## ComPact NSXm accessories and auxiliaries

- Overview ..... C-2
- Power connection of fixed devices ..... C-4
- Insulation of live parts ..... C-6
- Selection of auxiliaries ..... C-7
- Connection of auxiliaries ..... C-8
- Indication contacts ..... C-9
- Voltage release ..... C-10
- SDx module for MicroLogic Vigi 4.1 ..... C-11
- Rotary handles ..... C-12
- Locks and sealing accessories ..... C-14

## ComPact NSX accessories and auxiliaries

- Overview fixed version ..... C-16
- Overview plug-in and withdrawable versions ..... C-17
- Device installation ..... C-18
- Connection of fixed devices ..... C-20
- Connection of withdrawable and plug-in devices ..... C-22
- Insulation of live parts ..... C-23
- Selection of auxiliaries ..... C-24
- Connection of electrical auxiliaries ..... C-28
- Indication contacts ..... C-30
- SDx and SDTAM ..... C-31
- Motor mechanism ..... C-32
- Remote tripping ..... C-33
- Rotary handles ..... C-34
- Manual and Automatic Transfer Switch ..... C-36
- Mechanical interlocking ..... C-37
- Mechanical and electrical interlocking for source-changeover systems ..... C-38
- Automatic source-changeover systems with controller ..... C-39
- Additional measurement module: PowerLogic PowerTag NSX... C-40
- Additional measurement and indication modules ..... C-42
- Locks ..... C-44
- Sealing accessories ..... C-45
- Individual enclosures ..... C-46
- Escutcheons and protection collars ..... C-47

### Other chapters

- Select your circuit breakers and switch-disconnectors ..... A-1
- Select your protection ..... B-1
- Smart Panel integration ..... D-1
- Switchboard integration ..... E-1
- Catalog numbers ..... F-1
- Glossary ..... G-1
- Additional characteristics ..... H-1



# ComPact NSXm accessories and auxiliaries

## Overview

D6430566 eps

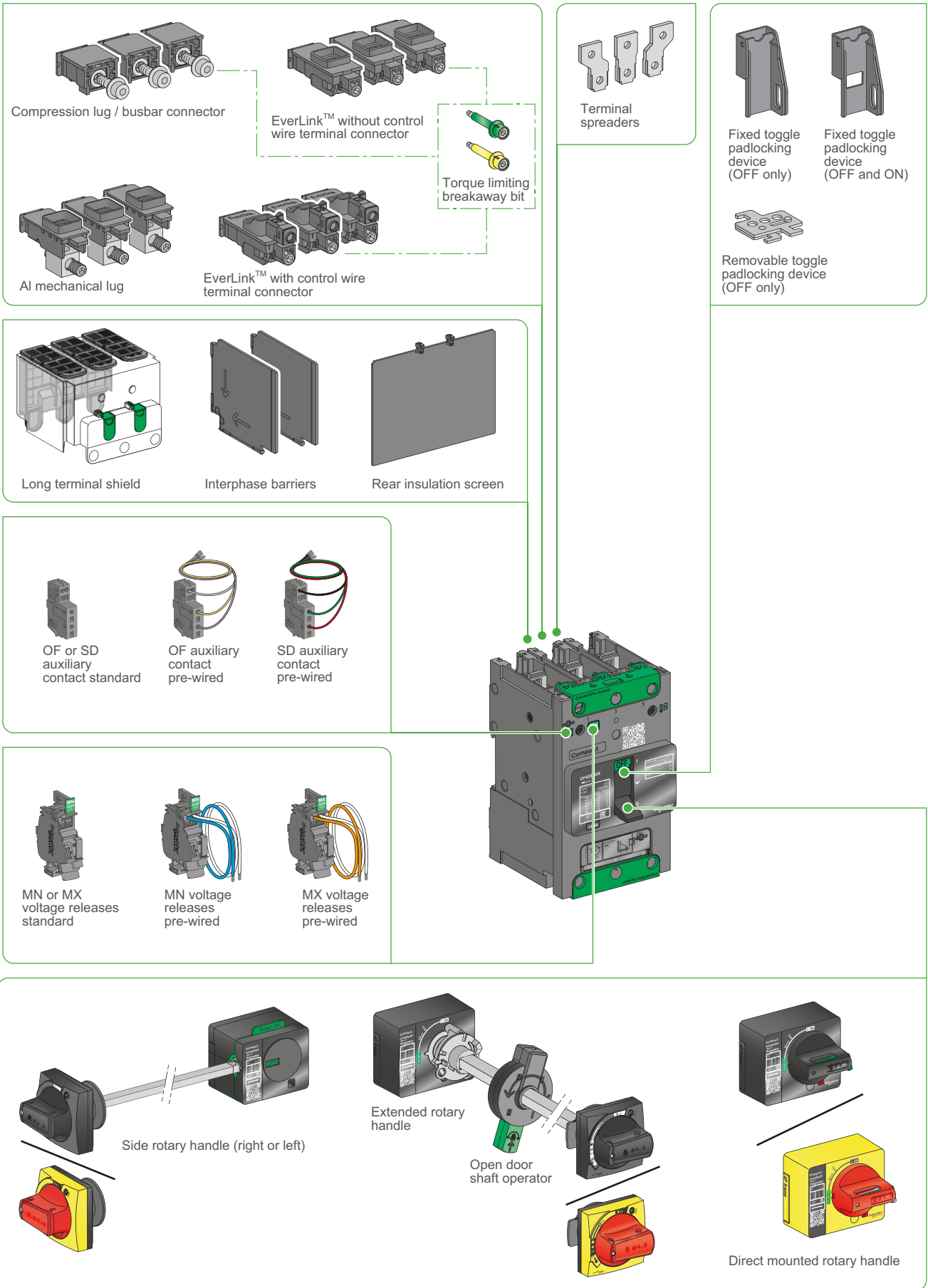



# Customize your circuit breaker with accessories ComPact NSXm accessories and auxiliaries

## Overview

DB430557 enp

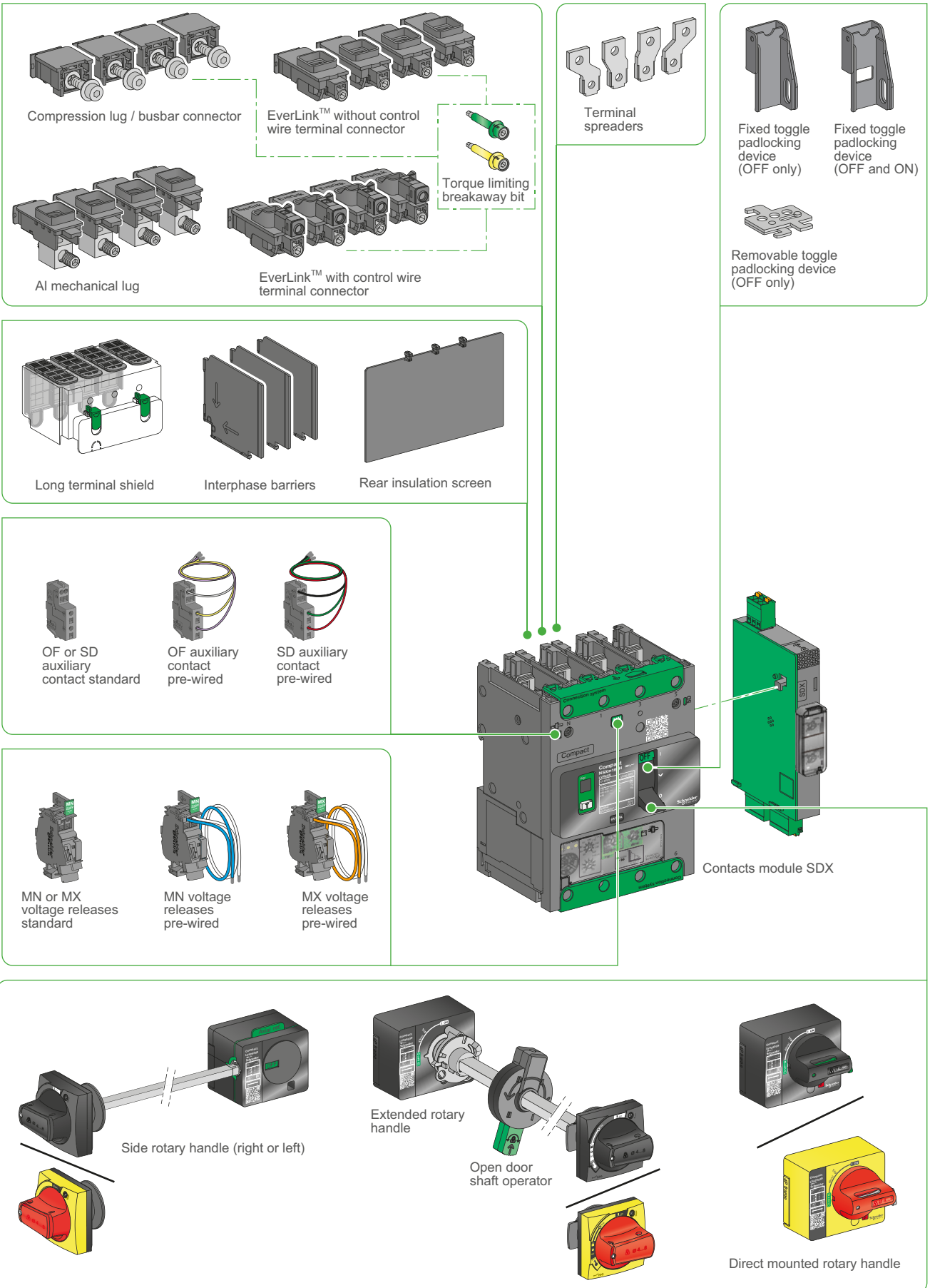

# ComPact NSXm accessories and auxiliaries

## Power connection of fixed devices



Fixed circuit breakers are designed for standard front connection using cables. Bars or cables with lugs connectors are also available.

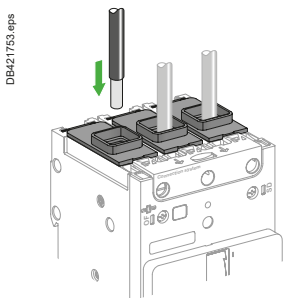
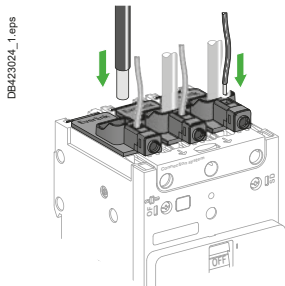
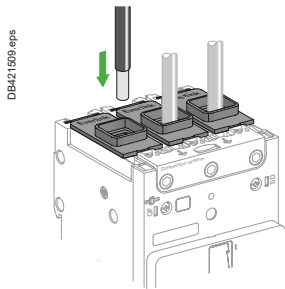

### Power connection

Circuit breakers are delivered with EverLink™ lug connectors for bare cables. They may be delivered with connectors for bars or cables with compression lugs. The connectors can be removed for the installation of one of the 4 kinds of connectors available (EverLink™ lug with control wire terminal, EverLink™ lug, compression lugs / busbar, aluminium mechanical lug). For connection of large cables, a number of solutions with spreaders may be used for both cables with lugs or bars.

### Bare cables

#### Standard terminal: EverLink™ lug connector

This type of connection uses the EverLink™ system with creep [1] compensation (Schneider Electric patent).

This technique makes it possible to achieve accurate and durable tightening torque, in order to avoid cable creep.

When ordered as spare part, EverLink™ connectors have control wire terminal in order to make some measurement connection (limited to 10 A).

#### EverLink™ lugs for use with Al or Cu wire

##### Wire range

Solid/stranded	Flexible	Torque
<b>Power connection 15-160 A (Cu), 15-100 A (Al)</b>		
2.5 - 10 mm <sup>2</sup>	2.5 - 10 mm <sup>2</sup>	5 N.m ±0.5
16 - 95 mm <sup>2</sup>	16 - 70 mm <sup>2</sup>	9 N.m ±0.9
<b>Control wire terminal up to 10 A (Cu)</b>		
1.5 - 6 mm <sup>2</sup>	0.5 - 6 mm <sup>2</sup>	1 N.m ±0.1

#### Aluminium mechanical connectors up to 125 A

The standard EverLink lugs can be removed for the installation of mechanical lugs. Lugs suitable for copper and aluminum conductors are made of tin-plated aluminum. The mechanical lugs are fastened to the terminals with lug mounting screws, inserted from the bottom of the circuit breaker. The lug cover is held in place with built-in snap features. They are sold as field installable kits.

#### Aluminium mechanical connectors up to 125 A

##### Power connection

Ampere rating	Wire range	
	Solid/stranded	Torque
15-125 A (Cu)	2.5 - 6 mm <sup>2</sup>	4 N.m ±0.4
15-125 A (Al)	10 - 70 mm <sup>2</sup>	5.6 N.m ±0.6

[1] Creep: normal crushing phenomenon of conductors, that is accentuated over time.



# Customize your circuit breaker with accessories

## ComPact NSXm accessories and auxiliaries

### Power connection of fixed devices

### Bars or cables with lugs

#### Compression lug / busbar connectors

The ComPact NSXm circuit breakers may be equipped with captive nuts and M6 screws connectors. These are readily field-installable, simply by removing the EverLink lug and replacing with the appropriate terminal nut.

They are also available factory installed. These terminals may be used for:

- direct connection of insulated bars or cables with compression (crimp) lugs.
- terminal extensions offering a wide range of connection possibilities.

#### Compression lug / busbar connectors, 15-160 A

Power connection	Torque
≤ 10 mm <sup>2</sup>	5 N.m ±0.5
≥ 16 mm <sup>2</sup>	9 N.m ±0.9

Interphase barriers or terminal shields are recommended. They are mandatory for certain connection accessories (in which case the interphase barriers are provided).

#### Crimp lugs large size cables

There are two models, for aluminium and for copper cables. It is necessary to use narrow lugs, compatible with device connections. They must be used with interphase barriers or long terminal shields.

The lugs are supplied with interphase barriers and may be used for the types of cables listed below.

#### Crimp lugs for use with ComPact NSXm

Copper cables	size	rigid	70 mm <sup>2</sup>	95 mm <sup>2</sup>	120 mm <sup>2</sup>
		flexible	50 mm <sup>2</sup>	70 mm <sup>2</sup>	95 mm <sup>2</sup>
	crimping	hexagonal barrels or punching			
Aluminium cables	size	rigid	95 mm <sup>2</sup>	120 mm <sup>2</sup>	
	crimping	hexagonal barrels			

#### Bars

When the switchboard configuration has not been tested, insulated bars are mandatory.

#### Bar and lugs dimensions

Dimensions	A	B	C	D	E
mm	6.4	≤ 8	≤ 20	7	≥ 17

#### Spreaders

Spreaders may be used to increase the pitch from 27 mm to 35 mm. Bars or cable lugs can be attached to the ends.

They are provided with M8 screws for power connection and interphase barriers (not compatible with long terminal shield). Rear insulation screens may have to be used too depending on the distance between the live uninsulated parts and the grounded metallic back pan.

### Torque limiting breakaway bits

Torque limiting breakaway bits may be used, particularly in the field, to tighten at the right torque EverLink™, compression lug or busbar power connections.

#### Throwaway tips

Circuit breaker application			Qty per kit
Ampere rating	Torque		
16-160 A	5 N.m		6 or 8
16-160 A	9 N.m		6 or 8

DB421507.eps

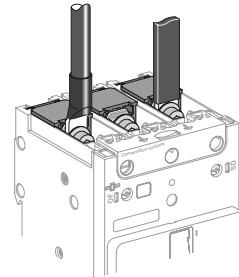

DB418860.eps

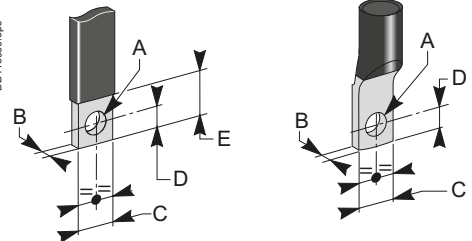

DB421755.eps

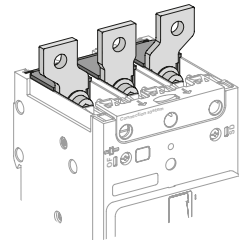

DB423025.eps

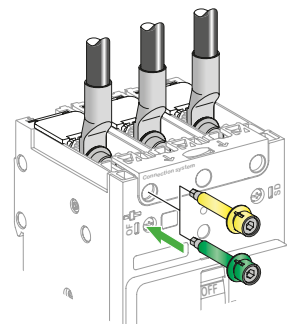

Customize your circuit breaker with accessories

# ComPact NSXm accessories and auxiliaries

## Insulation of live parts

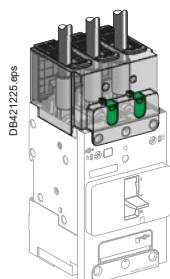

Long terminal shields.

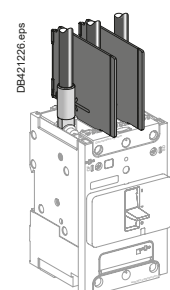

Interphase barriers.

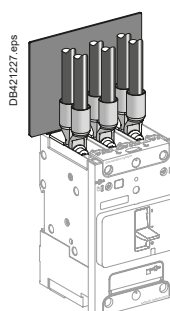

Rear insulating screens.

### Long terminal shields IP40

ComPact NSXm 3P or 4P can be equipped with long terminal shields. They can be mounted upstream and downstream and are used for protection against direct contact with power circuits. They provide IP40 degree of protection and IK07 mechanical impact protection. Moreover long terminal shields can be mounted after product installation on plate or DIN rail, and can be removed and put in place even if there are auxiliary wires.

They are used for connection with cables or insulated bars.

They are comprised of two parts assembled with 2 locks and/or captive screws, forming an IP40 cover.

- The top part is transparent in order to be able to see the connection through it and is equipped with sliding grids with break marks for precise adaptation to cables or insulated bars.

- The rear part completely blocks off the connection zone. Partially cut squares can be removed to adapt to all types of connection for cables with lugs or copper bars.

### Interphase barriers

Safety accessories for maximum insulation at the power-connection points:

- they clip easily onto the circuit breaker
- not compatible with long terminal shield
- 2 ways mounting: short / long insulation.

### Rear insulating screens

Safety accessories providing insulation at the rear of the device.

Their use may be mandatory if no long terminal shield depending of the distance between bare conductors and backplate.

The screen dimensions are shown below.

Circuit breaker	NSXm
3P W x H x thickness (mm)	110 x 84 x 1
4P W x H x thickness (mm)	145 x 84 x 1



# Customize your circuit breaker with accessories

## ComPact NSXm accessories and auxiliaries

### Selection of auxiliaries

#### Standard

All ComPact NSXm circuit breakers and switch-disconnectors have slots for the electrical auxiliaries listed below:

- 2 indication contacts (see page C-9) :
- 1 ON/OFF (OF)
- 1 trip indication (SD)
- either 1 MN undervoltage release or 1 MX shunt trip (see page C-10).

#### Remote indications

Circuit breakers with MicroLogic Vigi 4.1 may be equipped with an alarming / fault trip indication module to prevent to trip or to identify the type of fault (see page C-11).

All these auxiliaries may be installed with a rotary handle or a toggle handle.

The following drawing indicates auxiliary possibilities depending on the type of device.



#### Thermal magnetic circuit breaker (TM-D), switch (NA)

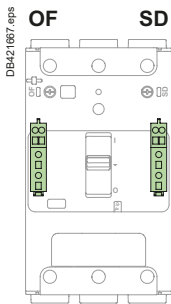

3 poles device

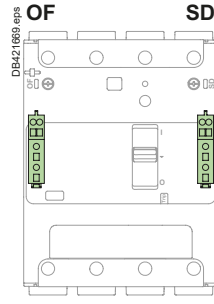
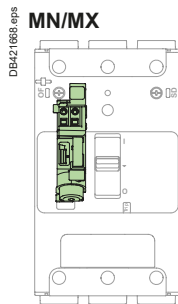

4 poles device

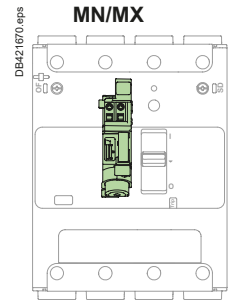

#### Earth leakage circuit breaker (MicroLogic Vigi 4.1)

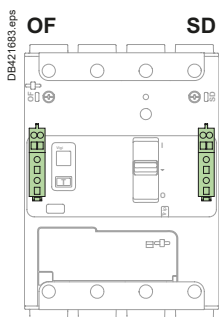

3/4 poles device in 4 poles footprint

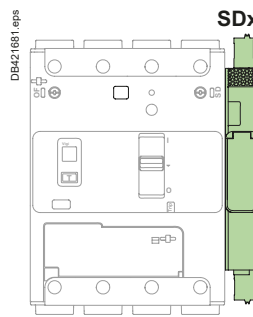
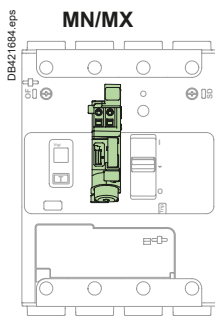

# ComPact NSXm accessories and auxiliaries

## Connection of auxiliaries

### Wiring

Electrical accessories are fitted with numbered spring terminal blocks for wires. The maximum wire size is 1.5 mm<sup>2</sup> for auxiliary switches (OF or SD), shunt trip MX or undervoltage release MN.

Electrical accessory wire routing can be exited out any of the four corners of the breaker, under the accessory cover even when using long terminal shield

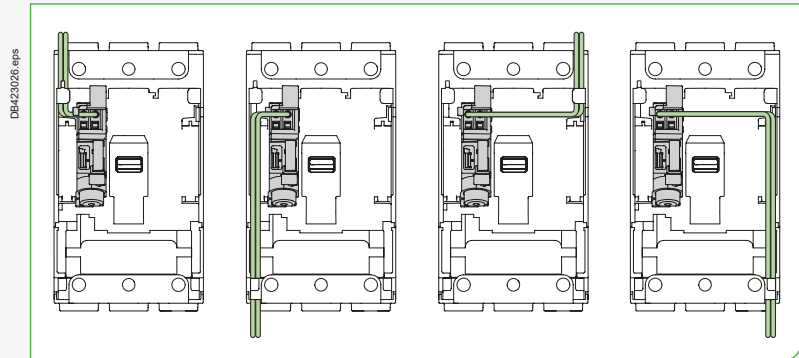

# Customize your circuit breaker with accessories

## ComPact NSXm accessories and auxiliaries

### Indication contacts

### Auxiliary and alarm indication contacts

Indication contacts provide remote information of the circuit breaker status and can thus be used for indications, electrical locking, relays, etc. They are common point changeover type contacts, with a normally open (NO) contact and a normally closed (NC) contact.

#### Open/Closed - Auxiliary switches (OF)

- Indicates the position of the circuit breaker contacts.

#### Trip indication - Alarm switch (SD)

- Indicates that the circuit breaker has tripped due to:
  - an electrical fault (overload, short circuit)
  - the operation of a shunt trip
  - undervoltage release
  - the "push-to-trip" button.
- Resets when the circuit breaker is reset.

#### Installation and connection

- The auxiliary switch (OF) and alarm switch (SD) indication contacts snap into cavities behind the front accessory cover of the circuit breaker and their presence is visible on the front face through green flags.
- One model serves for all indication functions depending on where it is fitted in the circuit breaker.
- Each NO and NC spring terminal may be connected by one 0.5...1.5 mm<sup>2</sup> flexible copper wire and by two for the common point.

#### Electrical characteristics of auxiliary contacts

Characteristics						
Rated thermal current (A)	5					
Minimum load	2 mA at 17 V DC					
Utilization cat. (IEC 60947-5-1)	AC12	AC15	DC12	DC13	DC14	
Operational current (A)	24 V AC/DC	5	5	5	2.5	1
	48 V AC/DC	5	5	2.5	1.2	0.2
	110...127 V AC / 110 V DC	5	4	0.6	0.35	0.05
	220/240 V AC	5	3	-	-	-
	250 V DC	-	-	0.3	0.05	0.03
	380/440 V AC	5	2.5	-	-	-
660/690 V AC	5	0.1	-	-	-	

#### Standards

- Auxiliary indicator contacts comply with IEC 60947-5-1.
- Auxiliary contacts have also been tested according IEC 60 947-5-4.



Auxiliary Switch (OF) / Alarm Switch (SD).

PB119125\_L12.eps

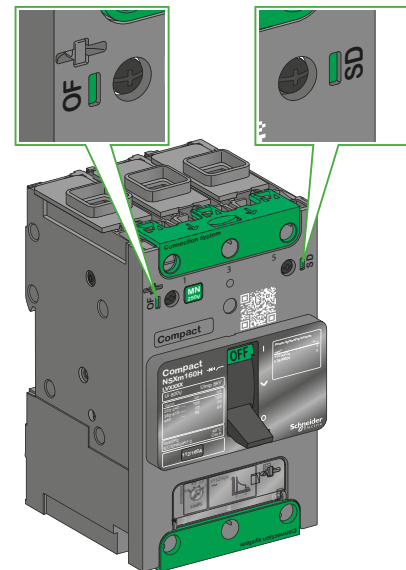

DB423028.eps

Customize your circuit breaker with accessories

# ComPact NSXm accessories and auxiliaries

## Voltage release



PB11983.eps

MX or MN voltage release.

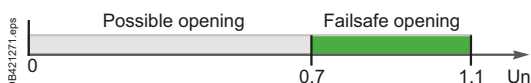

Opening conditions of the MX release.

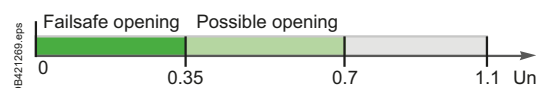

Opening conditions of the MN release.



Closing conditions of the MN release.

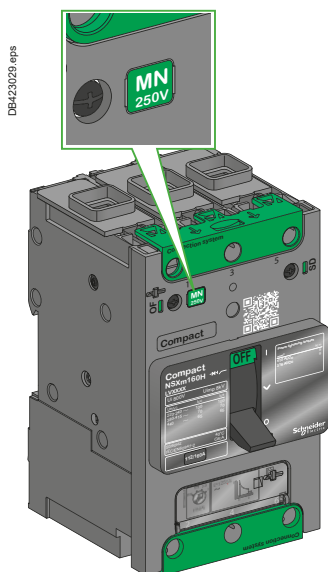

DB42029.eps

Operating voltages for MN/MX.

### Shunt trip (MX) and undervoltage release (MN)

A voltage release can be used to trip the circuit breaker using a control signal. They serve primarily for remote, emergency-off commands. It is advised to test the system every six months.

#### Shunt trip (MX)

- Trips the circuit breaker when the control voltage rises above 70 % of its rated voltage ( $U_n$ ).
- Impulse type  $\geq 20$  ms or maintained control signals.
- Shunt trip 110...130 V AC is suitable for ground-fault protection when combined with a Class I ground-fault sensing element.
- Continuous duty rated coil <sup>[1]</sup>.

#### Undervoltage release (MN)

- Trips the circuit breaker when the control voltage drops below 35 % of its rated voltage.
- Between 35 % and 70 % of the rated voltage opening is possible but not guaranteed.
- Above 70 % of the rated voltage, opening does not take place.
- Continuous duty rated coil.
- Circuit breaker closing is possible only if the voltage exceeds 85 % of the rated voltage. If an undervoltage condition exists, operation of the closing mechanism of the circuit breaker will not permit the main contacts to touch, even momentarily. This is commonly called "Kiss Free".

#### Time-delay unit for an undervoltage release (MN)

- A time delay unit eliminates the risk of nuisance tripping due to a transient voltage dip lasting less than 200 ms for fixed delay units and up to 3 seconds for adjustable units. For shorter micro-outages, a system of capacitors provides temporary supply to the MN at  $U > 0.7 U_n$  to ensure non tripping.

The correspondence between MN and time-delay units is shown below.

Power supply	Corresponding MN
<b>Unit with fixed delay 200 ms</b>	
48 V AC	48 V DC
220 / 240 V AC	250 V DC
<b>Unit with adjustable delay <math>\geq 200</math> ms</b>	
48 - 60 V AC/DC	48 V DC
100 - 130 V AC/DC	125 V DC
220 - 250 V AC/DC	250 V DC

#### Installation and connection

- Accessories snap into cavities under the front accessory cover of the circuit breaker. The presence and characteristics of the voltage release is visible from the front face through a window
- Terminals are spring type in order to insure a fast and reliable connection
- Each terminal may be connected by one 0.5...1.5 mm<sup>2</sup> flexible copper wire.

#### Operation

- The circuit breaker must be reset locally after being tripped by shunt trip (MX) or undervoltage release (MN)
- Tripping by the shunt trip or undervoltage release has priority over manual closing; in the presence of a standing trip order such an action does not result in any closing, even temporarily, of the main contacts
- Endurance: 50 % of the rated mechanical endurance of the circuit breaker.

#### Standard

- MN/MX voltage releases comply with IEC 60947-2.

[1] Except for MX 24 V AC/DC (in case of continuous activation, may generate some minor perturbation in sensitive environment).



# Customize your circuit breaker with accessories

## ComPact NSXm accessories and auxiliaries

### SDx module for MicroLogic Vigi 4.1

### SDx module for ComPact NSXm MicroLogic Vigi 4.1

The SDx module provides alarming and fault differentiation for the ComPact NSXm with MicroLogic Vigi 4.1.

This module has 2 NO/NC outputs dry contacts. Each can be assigned with one of the following status:

- overload alarm (SDT105): current is higher than 105 % of the setting current (I<sub>r</sub>)
- overload trip indication (SDT): circuit breaker has tripped due to an overload fault
- earth leakage alarm (SDV80): leakage current is higher than 80 % of the earth leakage trip threshold (I<sub>Δn</sub>)
- earth leakage trip indication (SDV): circuit breaker has tripped due to an earth leakage current.

Outputs are automatically reseted either when alarm disappear or when the circuit breaker is restarted.

#### Output characteristics

- 2 NO/NC dry contacts
- 24...250 V AC/DC
- 2 mA...5 A max
- AC15 (230 V max - 400 VA)
- DC13 (24 V - 50 W)

#### Power characteristics

- 24...240 V AC/DC

#### Front face indication



- green led "On": flashes slowly when the module is powered
- 2 red led for output status indication
- 2 setting dials

#### Installation and connection

The SDx module is clipped on the right side on the circuit breaker. Each removable spring terminal can be connected by one 0.5... 1.5 mm<sup>2</sup> copper wire.

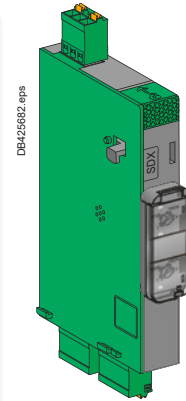

SDx relay module with its terminal block.

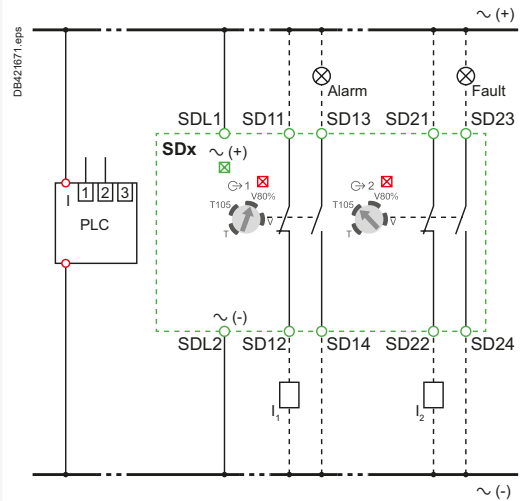

SDx wiring diagram.



# ComPact NSXm accessories and auxiliaries

## Rotary handles

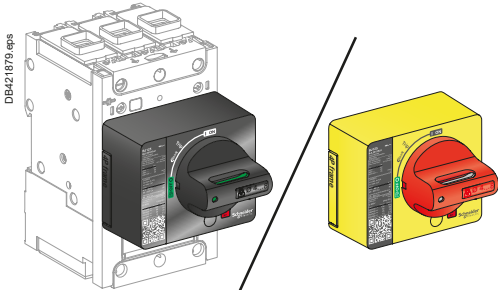

Directly mounted rotary handle.

### Direct rotary handles

#### Installation

The direct mounted rotary handle has to be mounted by 3 screws on the front accessory cover.

#### Operation

The direct rotary handle maintains:

- suitability for isolation
- indication of the three positions OFF (O), ON (I) and tripped (Trip)
- access to the "push-to-trip" button
- visibility and access to the trip unit.

#### Device padlocking

The circuit breaker may be locked in the OFF position by using one to three padlocks (not supplied) or in ON position after customer modification of the rotary handle before installation, padlock shackle Ø4-8 mm. Locking in the ON position does not prevent the circuit breaker from tripping if a fault occurs. In this case, the handle remains in the ON position after the circuit breaker trips. Unlocking is required for the handle to go to the tripped then the OFF position.

#### Variations: door locking

Door locking built-in functionality can be activated by the customer to prevent opening the door when the circuit breaker is ON or in trip position. For exceptional situations, door locking can be temporarily disabled with a tool by qualified personnel to open the door when the circuit breaker is closed.

#### Models

- Standard with black handle.
- VDE type with red handle and yellow bezel for machine tool control.

### Extended rotary handles

#### Installation

The door-mounted (extended) rotary handle is made up of:

- a unit that has to be screwed on the front accessory cover of the circuit breaker
- an assembly (handle mechanism and front plate) on the door that is always secured in the same position, whether the circuit breaker is installed vertically or horizontally
- an adjustable extension shaft.

The handle mechanism is fixed with a nut (Ø22 mm) to make assembly easier. The Laser Square tool (GVAPL01) can be used to accurately align the hole on the door with the circuit breaker.

#### Operation when door is closed

The door mounted handle makes it possible to operate a circuit breaker installed in an enclosure from the front. The door mounted operating handle maintains:

- suitability for isolation
- indication of the three positions OFF (O), ON (I) and tripped (Trip)
- visibility and access to trip unit when the door is open
- degree of protection of the handle on the door: IP54 or IP65 as per 60520.

#### Mechanical door locking when device closed

A standard feature of the extended rotary handle is a locking function, built into the shaft, that disables door opening when the circuit breaker is in the ON or tripped positions.

Door locking can be temporarily disabled with a tool by qualified personnel to open the door without opening the circuit breaker. This operation is not possible if the handle is locked by a padlock.

#### Device and door padlocking

Padlocking locks the circuit breaker handle and disables door opening:

- standard situation, in the OFF position, using 1 to 3 padlocks, shackle Ø4-8 mm, padlocks are not supplied
- for the black handle, with a voluntary modification of the door handle (to be done by the customer during installation), in the ON and OFF positions. Locking in the ON position does not prevent the circuit breaker from tripping if a fault occurs. In this case, the handle remains in the ON position after the circuit breaker trips. Unlocking is required for the handle to go to the tripped then the OFF position.

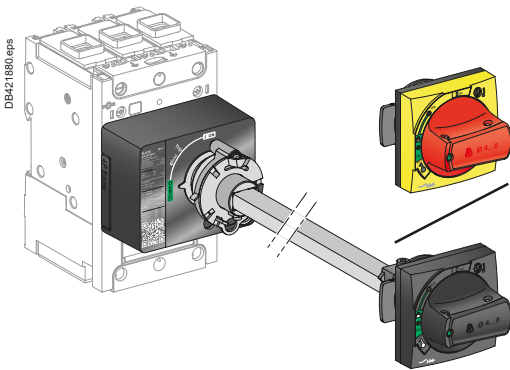

Door-mounted rotary handle.

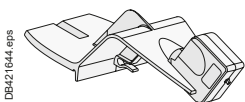

Laser Square tool.

# Customize your circuit breaker with accessories

## ComPact NSXm accessories and auxiliaries

### Rotary handles

#### Operation when door is opened

An open door shaft operator can be used to operate the circuit breaker when door is opened. This accessory complies with UL 508A.

The indication of the three positions OFF (O), ON (I) and tripped (Trip) is visible on the circuit breaker.

The circuit breaker itself may be locked in OFF position when the door is opened by 1 padlock / lockout hasp, shackle Ø4-8 mm.

#### Shaft length

The shaft length is the distance between the back of the circuit breaker and the door:

- minimum shaft length is 200 mm
- maximum shaft length is 600 mm
- shaft length must be adjusted.

#### Models

- Standard with black handle (IP54).
- VDE type with red handle and yellow bezel for machine tool control (IP54).
- IP65 with red handle and yellow bezel.

## Side rotary handles (left or right)

#### Installation

The side-mounted rotary handle is made up of:

- a unit that has to be screwed on the front accessory cover of the circuit breaker
- an assembly (handle and front plate) on the side (left or right) of the enclosure
- an adjustable extension shaft.

The handle mechanism is fixed with a nut (Ø22 mm) to make assembly easier.

#### Operation

The side mounted rotary handle makes it possible to operate circuit breakers installed in enclosure from the side. The side mounted rotary handle maintains:

- suitability for isolation
- indication of the three positions OFF (O), ON (I) and tripped (Trip). Moreover, the position is visible on the circuit breaker itself.
- visibility and access to trip unit when the door is open
- degree of protection of the handle on the side: IP54 or IP65 as per 60520.

#### Device padlocking

The circuit breaker may be locked in the OFF position, or, for the black rotary handle only, in ON position after voluntary modification of the side handle (to be done by the customer during installation), by using one to three padlocks, padlock shackle Ø4-8 mm ; padlocks are not supplied.

Locking in the ON position does not prevent free circuit breaker from tripping if a fault occurs. In this case, the handle remains in the ON position after the circuit breaker tripping. Unlocking is required to go to the tripped then the OFF position.

#### Shaft length

The shaft length is the distance between the side of the circuit breaker and the side of the enclosure:

- minimum shaft length is 45 mm
- maximum shaft length is 480 mm
- shaft length must be adjusted.

#### Models

- Standard with black handle (IP54).
- VDE type with red handle and yellow bezel for machine tool control (IP54).
- IP65 with red handle and yellow bezel (by ordering a standard one and an IP65 universal handle).

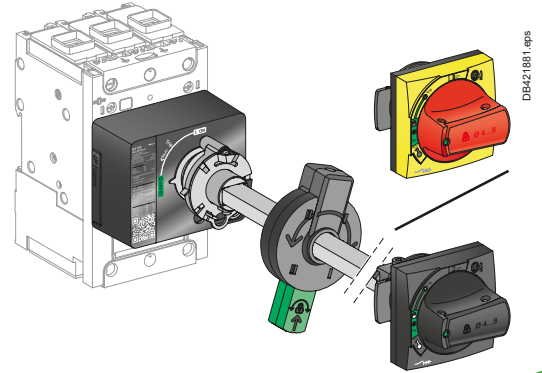

Door-mounted rotary handle with open door shaft operator.

DB421881.eps

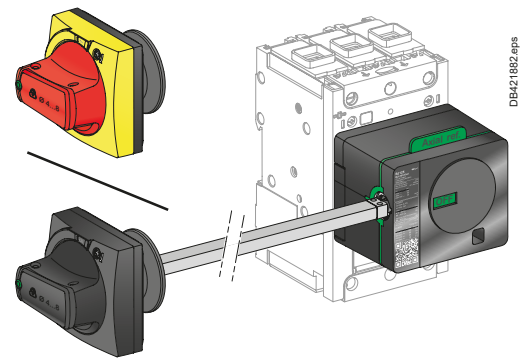

Side mounted rotary handle.

DB421882.eps

C

# ComPact NSXm accessories and auxiliaries

## Locks and sealing accessories

### Locks

Padlocking systems can receive up to three padlocks with diameters of 5-8 mm ; padlocks not supplied. Locking in the OFF position guarantees isolation as per IEC 60947-2.

Control device	Function	Means	Required accessories
Toggle	Lock in OFF position	Padlock	Removable device
	Lock in OFF or ON position	Padlock	Fixed device
Direct rotary handle	Lock in OFF position	Padlock	Fixed device
	Lock in <ul style="list-style-type: none"> <li>■ OFF position</li> <li>■ OFF or ON position <sup>[1]</sup></li> </ul>	Padlock	-
Extended/side rotary handle	Lock in <ul style="list-style-type: none"> <li>■ OFF position</li> <li>■ OFF or ON position <sup>[2]</sup></li> </ul> with door opening prevented	Padlock	-

[1] Following a simple modification of the mechanism.

[2] Following a simple modification of the mechanism - black handle only.

### Handle padlocking device <sup>[1]</sup>

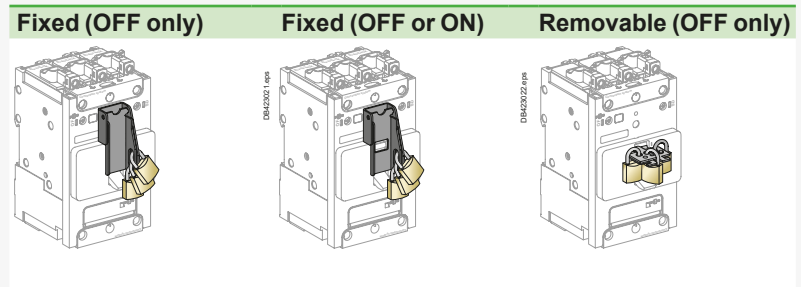

[1] Rotary handle has integrated padlocking capability.

# Customize your circuit breaker with accessories

## ComPact NSXm accessories and auxiliaries

### Locks and sealing accessories

### Sealing accessories

Sealing accessories are available. Each bag of accessories contains all the parts required for the types of sealing indicated below.

A bag contains:

- 6 sealing accessories
- 6 lead seals.

### Types of seals and corresponding functions

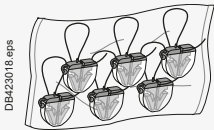

LV429335: Bag of sealing accessories.

Protected operations			
Control type	■ Front removal ■ Access to auxiliaries.	■ Access to power connections	■ Access to settings and test connector
Toggle			
Rotary handle			



# ComPact NSX accessories and auxiliaries

## Overview fixed version

DBA-30180\_eps

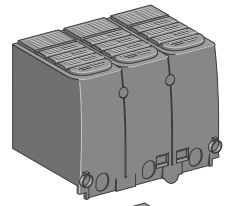

Sealable terminal shields

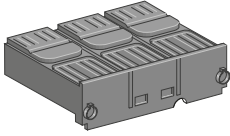

Interphase barriers

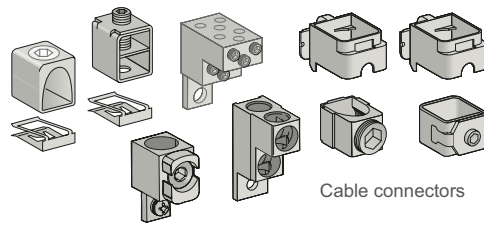

Cable connectors

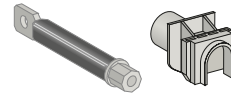

Rear connectors

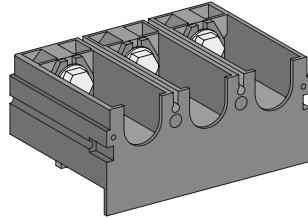

One-piece spreader

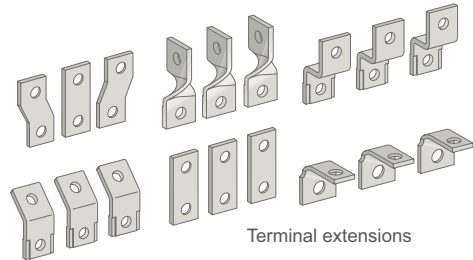

Terminal extensions

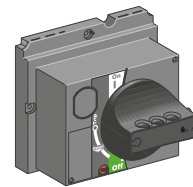
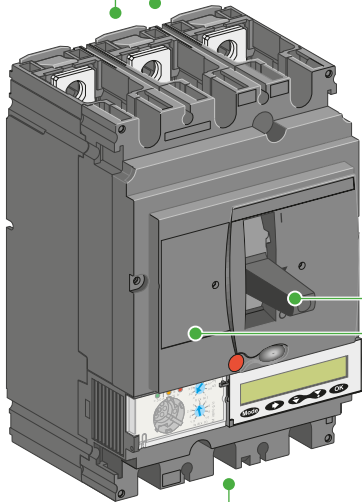

Direct rotary handle

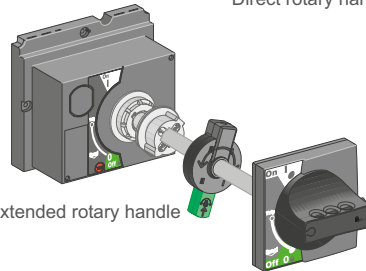

Extended rotary handle

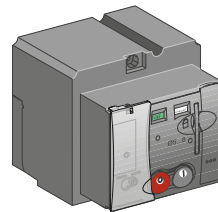

Motor mechanism

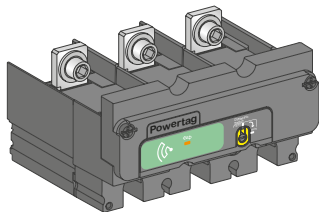

PowerTag NSX

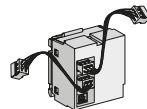

BSCM module



Indication contact



Voltage release



SDTAM module



SDx module

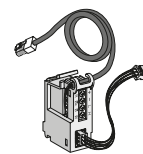

NSX cord

# ComPact NSX accessories and auxiliaries

## Overview plug-in and withdrawable versions

DB632572 eps

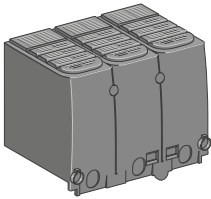

Sealable long terminal shields for plug-in base

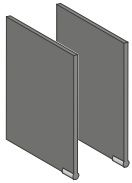

Interphase barriers

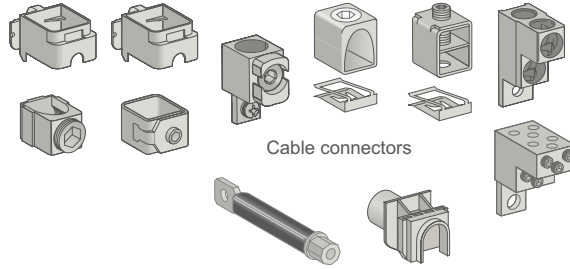

Cable connectors

Rear connectors

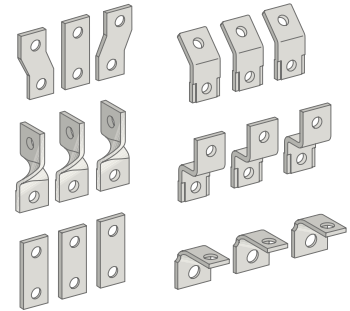

Terminal extensions

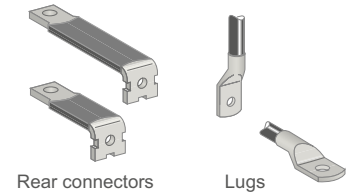

Rear connectors

Lugs

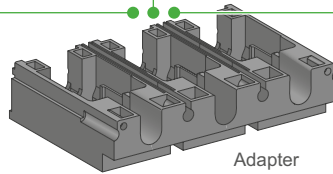

Adapter

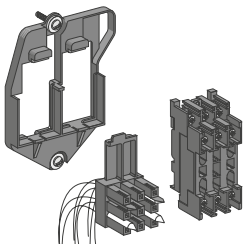

Automatic withdrawable auxiliary connector

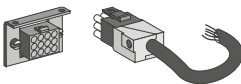

Manual auxiliary connector

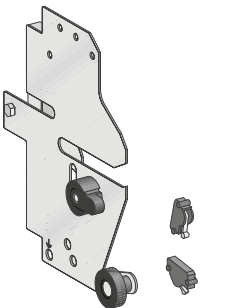
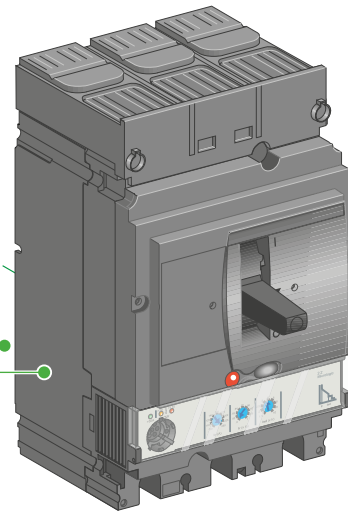
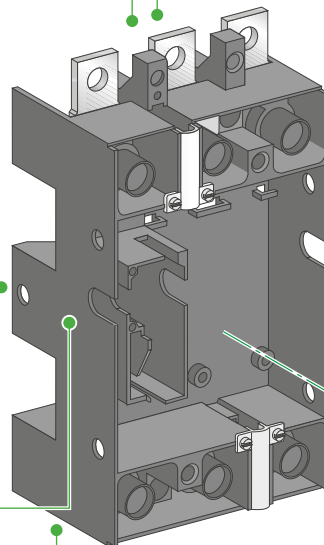

Chassis side plate

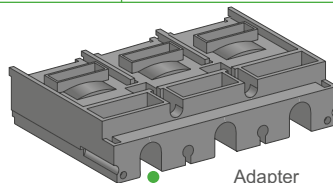

Adapter

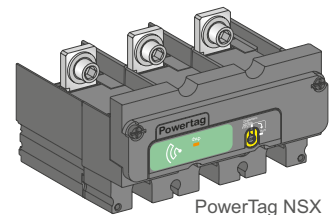

PowerTag NSX

[1]

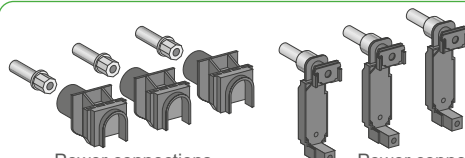

Power connections

Power connections for Vigi add-on

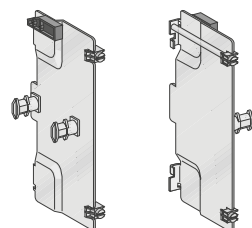

Circuit breaker side plate

[1] For PowerLogic PowerTag NSX 630 A, add a 4 mm intercalary under the module when plate mounted (see page C-43).



# ComPact NSX accessories and auxiliaries

## Device installation

### Plug-in circuit breakers

The plug-in version makes it possible to:

- extract and/or rapidly replace the circuit breaker without having to touch the connections on the base
- allow for the addition of future circuits by installing bases that will be equipped with a circuit breaker at a later date
- isolate the power circuits when the device is mounted on or through a panel. It acts as a barrier for the connections of the plug-in base. Insulation is made complete by the mandatory short terminal shields on the device. The degrees of protection are:
  - circuit breaker plugged in = IP4
  - circuit breaker removed = IP2
  - circuit breaker removed, base equipped with shutters = IP4.

#### Parts of a plug-in configuration

A plug-in configuration is made by adding a "plug-in kit" to a fixed device. To avoid connecting or disconnecting the power circuits under load conditions, a safety trip causes automatic tripping if the device is ON, before engaging or withdrawing it. The safety trip, supplied with the kit, must be installed on the device. If the device is disconnected, the safety trip does not operate. The device can be operated outside the switchboard.

#### Accessories

Optional insulation accessories are available.

- Terminal shields to protect against direct contact.
- Interphase barriers to reinforce insulation between phases and protect against direct contact.

#### Mounting

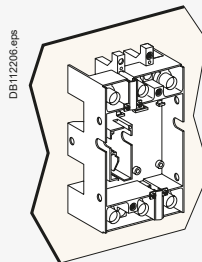

Mounting on a backplate.

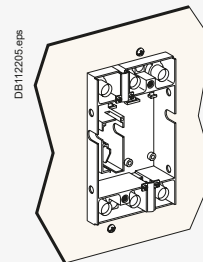

Mounting through a front panel.

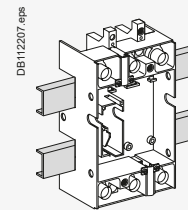

Mounting on rails.



# Customize your circuit breaker with accessories

## ComPact NSX accessories and auxiliaries

### Device installation

### Withdrawable circuit breakers

In addition to the advantages provided by the base, installation on a chassis facilitates handling. It offers three positions, with transfer from one to the other after mechanical unlocking:

- connected: the power circuits are connected
- disconnected: the power circuits are disconnected, the device can be operated to check auxiliary operation
- removed: the device is free and can be removed from the chassis.

#### Parts of a withdrawable configuration

A withdrawable configuration requires two side plates installed on the base and two sides plates mounted on the circuit breaker. Similar to the plug-in version, a safety trip causes automatic tripping if the device is ON, before engaging or withdrawing it, and enables device operation in the disconnected position.

#### Accessories

Accessories are the same as for the base, with in addition:

- auxiliary contacts for installation on the fixed part, indicating the "connected" and "disconnected" positions
- locking by 1 to 3 padlocks (shackle diameter 5 to 8 mm), to:
  - prevent insertion for connection
  - lock the circuit breaker in connected or disconnected position
- toggle collar for circuit breakers with a toggle mounted through a front panel, intended to maintain the degree of protection whatever the position of the circuit breaker (supplied with a toggle extension)
- telescopic shaft for extended rotary handles. The door can then be closed with the device in the connected and disconnected positions.

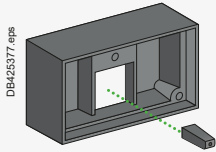

DB425377.eps  
Protection collar for toggle and toggle extension to provide IP4 in the connected and disconnected positions.

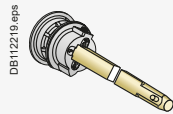

DB112219.eps  
Telescopic shaft.

### Mounting

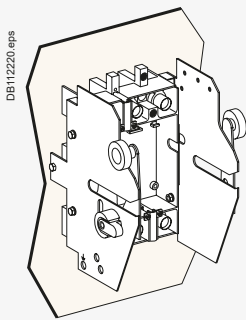

DB112220.eps  
Mounting on a backplate.

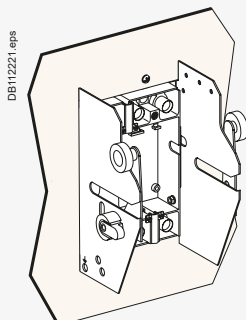

DB112221.eps  
Mounting through a front panel.

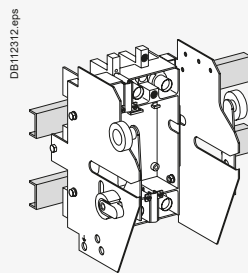

DB112312.eps  
Mounting on rails.



Withdrawable ComPact NSX250.

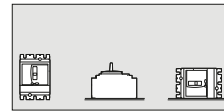

Installation positions.



Connected.

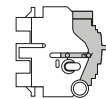

Disconnected.

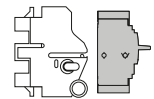

Removed.

FB105122.eps

DB112209.eps

DB 112210.eps



# ComPact NSX accessories and auxiliaries

## Connection of fixed devices

Fixed circuit breakers are designed for standard front connection using bars or cables with lugs. Cable connectors are available for bare cables. Rear connection is also possible.

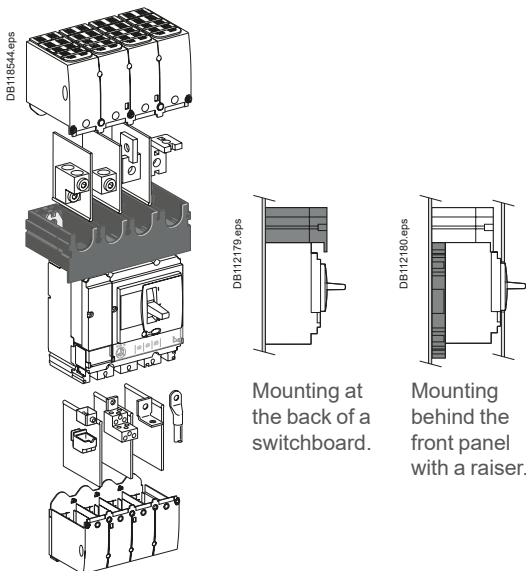
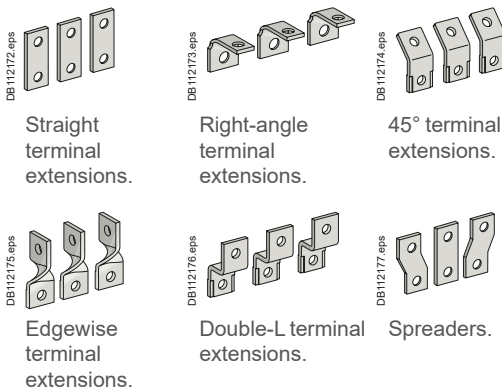
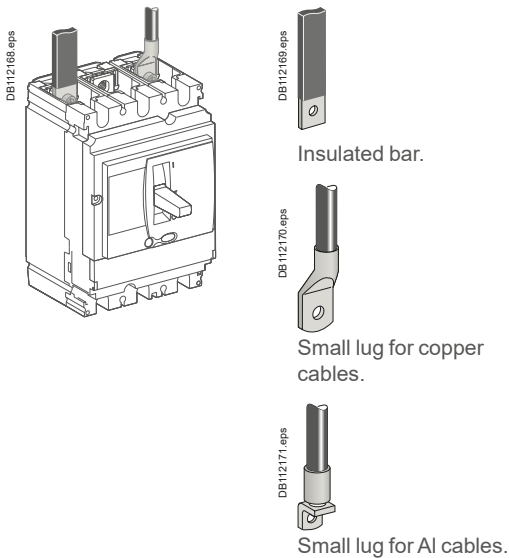

### Front connection

#### Bars or cables with lugs

##### Standard terminals

ComPact NSX100 to 630 come with terminals comprising snap-in nuts with screws:

- ComPact NSX100: M6 nuts and screws. ComPact NSX160/250: M8 nuts and screws
- ComPact NSX400/630: M10 nuts and screws.

These terminals may be used for:

- direct connection of insulated bars or cables with lugs
- terminal extensions offering a wide range of connection possibilities.

Interphase barriers or terminal shields are recommended. They are mandatory for certain connection accessories (in which case the interphase barriers are provided).

##### Bars

When the switchboard configuration has not been tested, insulated bars are mandatory.

##### Maximum size of bars

ComPact NSX circuit breaker		100/160/250	400/630
Without spreaders	pitch (mm)	35	45
	maximum bar size (mm)	20 x 2	32 x 6
With spreaders	pitch (mm)	45	52.5
	maximum bar size (mm)	32 x 2	40 x 10

##### Crimp lugs

There are two models, for aluminium and copper cables.

It is necessary to use narrow lugs, compatible with device connections. They must be used with interphase barriers or long terminal shields. The lugs are supplied with interphase barriers and may be used for the types of cables listed below.

##### Cable sizes for connection using lugs

ComPact NSX circuit breaker		100/160/250	400/630
Copper cables	size (mm <sup>2</sup> )	120, 150, 185	240, 300
	crimping	hexagonal barrels or punching	
Aluminium cables	size (mm <sup>2</sup> )	120, 150, 185	240, 300
	crimping	hexagonal barrels	

##### Terminal extensions

Extensions with anti-rotation ribs can be attached to the standard terminals to provide numerous connection possibilities in little space:

- straight terminal extensions
- right-angle terminal extensions
- edgewise terminal extensions
- double-L extensions
- 45° extensions.

##### Spreaders

Spreaders may be used to increase the pitch:

- NSX100 to 250: the 35 mm pitch can be increased to 45 mm
- NSX400/630: the 45 mm pitch can be increased to 52 or 70 mm.

Bars, cable lugs or cable connectors can be attached to the ends.

##### One-piece spreader for NSX100 to 250

Connection of large cables may require an increase in the distance between the device terminals.

The one-piece spreader is the means to:

- increase the 35 mm pitch of the NSX100 to 250 circuit-breaker terminals to the 45 mm pitch of a NSX400/630 device
- use all the connection and insulation accessories available for the next largest frame size (lugs, connectors, spreaders, right-angle and edgewise terminal extensions, terminal shields and interphase barriers).

It may also be used for ComPact INS switch-disconnectors.

Equipped with a single-piece spreader, ComPact NSX devices can be mounted:

- at the back of a switchboard
- behind the front panel with a raiser.

The one-piece spreader is also the means to:

- align devices with different frame sizes in the switchboard
- use the same mounting plate, whatever the device.

##### Pitch (mm) depending on the type of spreader

ComPact NSX circuit breaker	NSX100 to 250	NSX400 to 630
Without spreaders	35	45
With spreaders	45	52.5 or 70
With one-piece spreader	45	-

# ComPact NSX accessories and auxiliaries

## Connection of fixed devices

### Bare cables

For bare cables (without lugs), the prefabricated bare-cable connectors may be used for both copper and aluminium cables.

#### 1-cable connectors for ComPact NSX100 to 250

The connectors snap directly on to the device terminals or are secured by clips to right-angle and straight terminal extensions as well as spreaders.

#### 1-cable connectors for ComPact NSX400 to 630

The connectors are screwed directly to the device terminals.

#### 2-cable connectors for ComPact NSX100 to 250 and 400/630

The connectors are screwed to device terminals or right-angle terminal extensions.

#### Distribution connectors for ComPact NSX100 to 250

These connectors are screwed directly to device terminals. Interphase barriers are supplied with distribution connectors, but may be replaced by long terminal shields. Each connector can receive six cables with cross-sectional areas ranging from 1.5 to 35 mm<sup>2</sup> each.

#### Linery DX and Linery DP distribution block for ComPact NSX100 to 630

Linery DX and Linery DP connects directly to device terminals.

It is used to connect up to six or nine flexible or rigid cables with cross-sectional areas not exceeding 10 mm<sup>2</sup> or 16 mm<sup>2</sup>, to each pole.

Connection is made to spring terminals without screws.

### Maximum size of cables depending on the type of connector

ComPact NSX circuit breaker	100/160	250	400	630	
Steel connectors	1.5 to 95 mm <sup>2</sup>	●			
Aluminium connectors	25 to 95 mm <sup>2</sup>	●	●		
	120 to 185 mm <sup>2</sup>	●	●		
	120 to 240 mm <sup>2</sup>	●	●		
	2 cables 50 to 120 mm <sup>2</sup>	●	●		
	2 cables 35 to 240 mm <sup>2</sup>			●	●
	35 to 300 mm <sup>2</sup>			●	●
Distribution connectors	6 cables 35 mm <sup>2</sup>	●	●		
Linery DX and Linery DP distribution blocks	6 or 9 cables 10/16 mm <sup>2</sup>	●	●		

### Rear connection

Device mounting on a backplate with suitable holes enables rear connection.

### Bars or cables with lugs

Rear connections for bars or cables with lugs are available in two lengths. Bars may be positioned flat, on edge or at 45° angles depending on how the rear connections are positioned.

The rear connections are simply fitted to the device connection terminals. All combinations of rear connection lengths and positions are possible on a given device.

### Bare cables

For the connection of bare cables, the 1-cable connectors for ComPact NSX100 to 250 may be secured to the rear connections using clips.

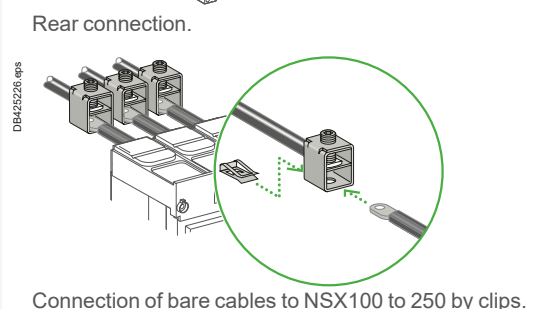
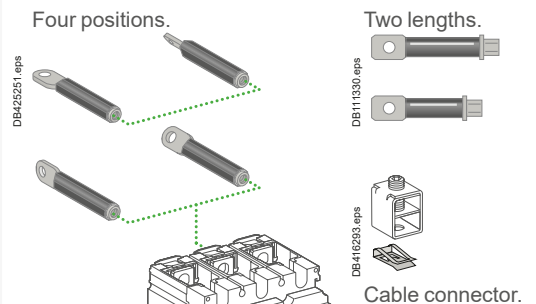
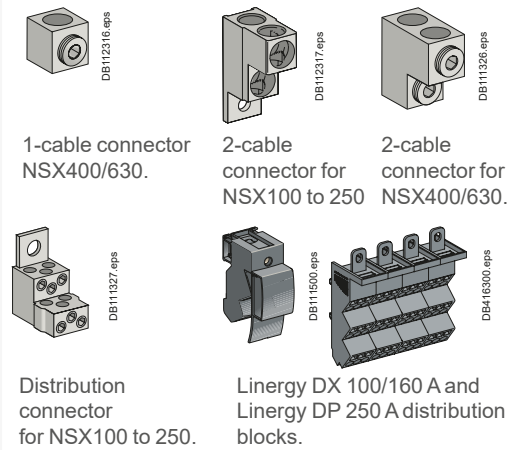
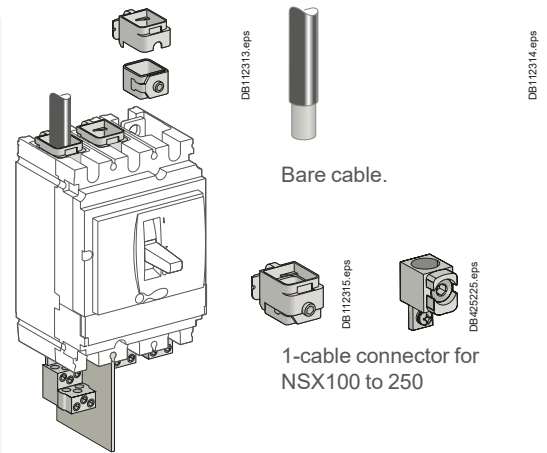

# ComPact NSX accessories and auxiliaries

## Connection of withdrawable and plug-in devices

Connection is identical for both withdrawable and plug-in versions. The same accessories as for fixed devices may be used.

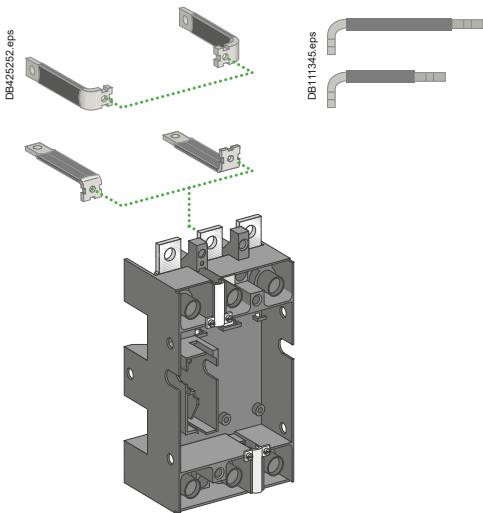

Four positions.

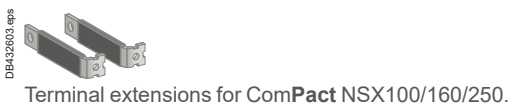

Terminal extensions for ComPact NSX100/160/250.

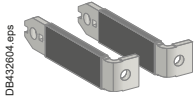

Terminal extensions for ComPact NSX400/630.

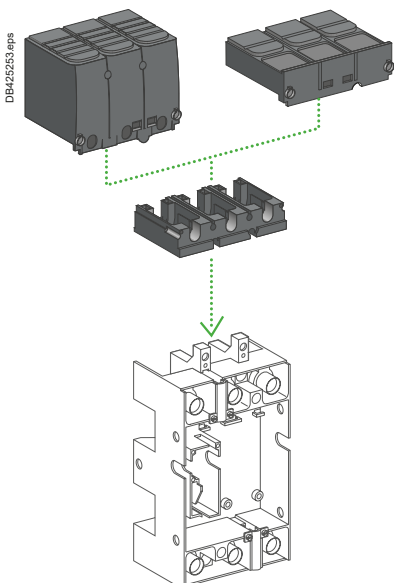

### Bars or cables with lugs

The plug-in base is equipped with terminals which, depending on their orientation, serve for front and rear connection.

For rear connection of a base mounted on a backplate, the terminals must be replaced by insulated, long right-angle terminal extensions.

For ComPact NSX630 devices, connection most often requires the 52.5 or 70 mm pitch spreaders.

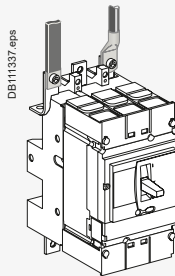

Front connection.

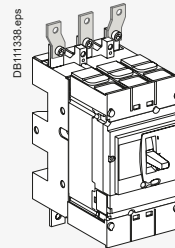

Front connection with spreaders.

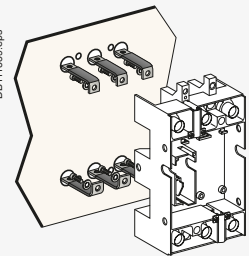

Rear connection of a base mounted on a backplate.

### Connection accessories

All accessories for fixed devices (bars, lugs, terminal extensions and spreaders) may be used with the plug-in base.

### Bare cables

All terminals may be equipped with bare-cable connectors. See the "Connection of fixed devices" section.

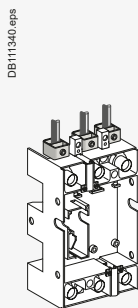

With a 100 to 250 A base.

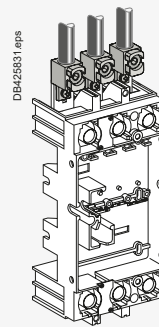

With 240 mm<sup>2</sup> cable connector for NSX100 to 250.

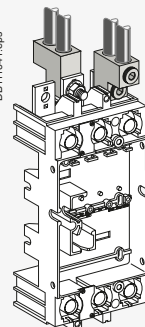

With a 400/630 A base.

### Adapter for plug-in base

The adapter is a plastic component for the 100 to 250 base and the 400/630 base that enables use of all the connection accessories of the fixed device.

It is required for interphase barriers and the long and short terminal shields.

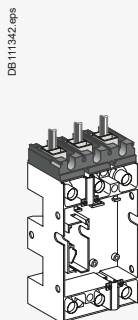

Adapter for 100 to 250 A - 3P base. Connection with bars or cables with lugs.

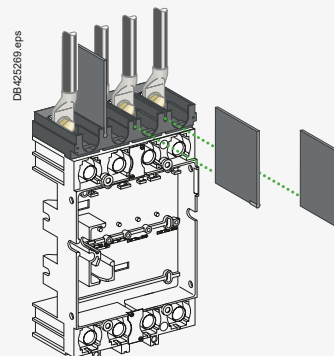

Adapter for 400/630 A - 4P base. Connection with spreaders and interphase barriers.

# Customize your circuit breaker with accessories

## ComPact NSX accessories and auxiliaries

### Insulation of live parts

### Terminal shields

Insulating accessories used for protection against direct contact with power circuits. They provide IP40 degree of protection and IK07 mechanical impact protection.

#### Terminal-shield types

ComPact NSX100 to 250 and NSX400/630 3P or 4P can be equipped with:

- short terminal shields
- short terminal shields ≥ 500 V
- long terminal shields.

All terminal shields have holes or knock-outs in front for voltage-presence indicators.

#### Short terminal shields

They are used with:

- plug-in and withdrawable versions in all connection configurations
- fixed versions with rear connection.

#### Long terminal shields

They are used for front connection with cables or insulated bars.

They comprise two parts assembled with captive screws, forming an IP40 cover.

■ The top part is equipped with sliding grids with break marks for precise adaptation to cables or insulated bars.

■ The rear part completely blocks off the connection zone. Partially cut squares can be removed to adapt to all types of connection for cables with lugs or copper bars.

Long terminal shields may be mounted upstream and downstream of:

- fixed devices
- the base of plug-in and withdrawable versions, thus completing the insulation provided by the mandatory short terminal shields on the device
- the one-piece spreader for NSX100 to 250
- the 52.5 mm spreaders for NSX400/630.

#### Terminal shields and pitch

Combination possibilities are shown below.

Circuit breaker	NSX100/160/250		NSX400/630
<b>Short terminal shields</b>			
Pitch (mm)	35	45	
<b>Long terminal shields</b>			
Pitch (mm)	35	45	52.5

### Interphase barriers

Safety accessories for maximum insulation at the power-connection points:

- they clip easily onto the circuit breaker
- single version for fixed devices and adapters on plug-in bases
- not compatible with terminal shields
- the adapter for the plug-in base is required for mounting on plug-in and withdrawable versions.

### Rear insulating screens

Safety accessories providing insulation at the rear of the device.

Their use is mandatory for devices with spreaders, installed on backplates, when terminal shields are not used.

The available screen dimensions are shown below.

Circuit breaker		NSX100/160/250	NSX400/630
3P	W x H x thickness (mm)	140 x 105 x 1	203 x 175 x 1.5
4P	W x H x thickness (mm)	175 x 105 x 1	275 x 175 x 1.5

Terminal shields are identical for fixed and plug-in/withdrawable versions and cover all applications up to 1000 V.

They exist for the 100 to 250 A and 400/630 A ratings, in long and short versions.

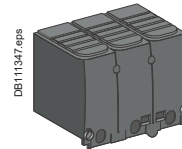

Long terminal shields.

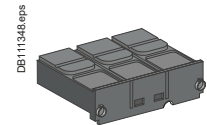

Short terminal shields.

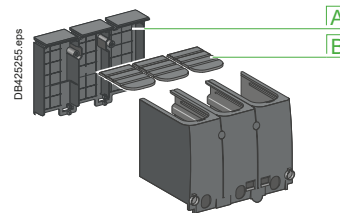

A Partially cut removable squares.

B Grids with break marks.

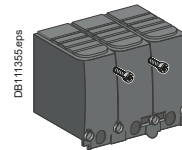

Assembled with captive screws.

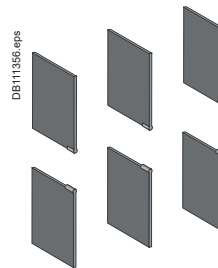

Interphase barriers.

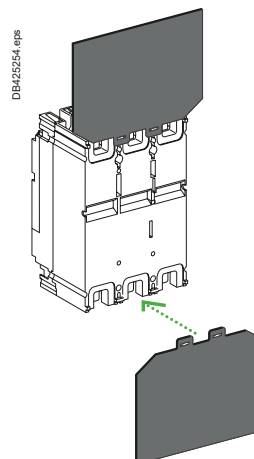

Rear insulating screens.



# ComPact NSX accessories and auxiliaries

## Selection of auxiliaries



### Standard

All ComPact NSX100/160/250 circuit breakers and switch-disconnectors have slots for the electrical auxiliaries listed below.

**5 indication contacts** (see page C-30)

- 2 ON/OFF (OF1 and OF2)
- 1 trip indication (SD)
- 1 fault-trip indication (SDE)
- 1 earth-fault indication (SDV), when the device is equipped with a Vigi add-on.

**1 remote-tripping release** (see page C-33)

- either 1 MN undervoltage release
- or 1 MX shunt release.

### Remote indications

Circuit breakers equipped with MicroLogic trip units may be equipped with a fault-trip indication to identify the type of fault by installing:

**1 indication module with two outputs** (see page C-31)

- either an SDx module with MicroLogic 2.2 / 4.2 / 5.2 A or E / 6.2 A or E or 7 E
- or an SDTAM module with MicroLogic 2.2 M or 6-2 E-M (motor protection).

This module occupies the slots of one OF contact and an MN/MX release.

**All these auxiliaries may be installed with a motor mechanism or a rotary handle or a toggle handle.**

The following table indicates auxiliary possibilities depending on the type of trip unit.

## NA, TMD, TMG, MA

### Standard

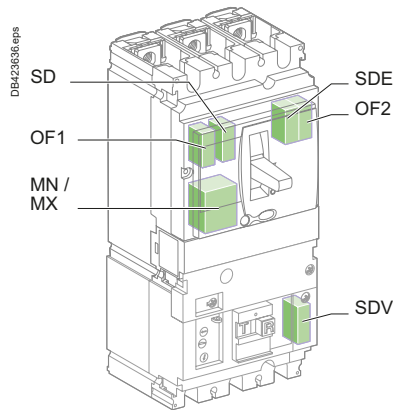
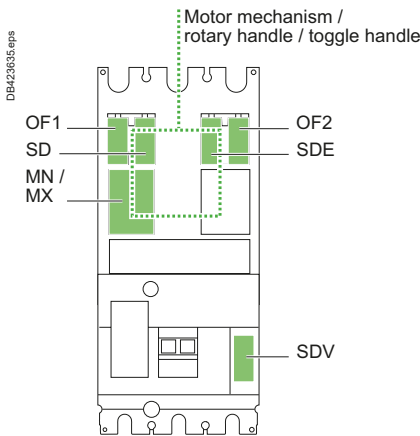

## MicroLogic 2 / 4 / 5 / 6 / 7

### Standard

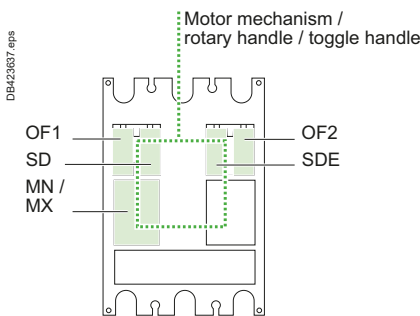

or

### Remote indications via SDx or SDTAM

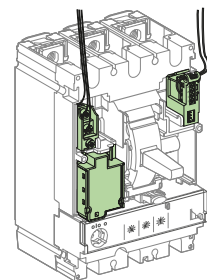
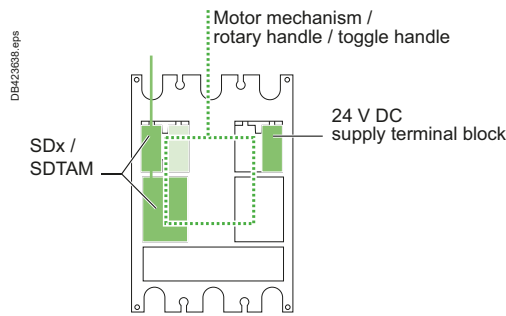

The SDx or SDTAM uses the OF1 and MN/MX slots.

External connection is made via a terminal block in the OF1 slot.

The 24 V DC supply provides for the MicroLogic 5 / 6 / 7 display when the device is OFF or under low-load conditions.

# Customize your circuit breaker with accessories

## ComPact NSX accessories and auxiliaries

### Selection of auxiliaries

### Communication

Communication requires specific auxiliaries.

#### Communication of status indications

- 1 BSCM module.
- 1 NSX cord (internal terminal block) for both communication and 24 V DC supply to the BSCM. The insulated NSX cord is mandatory for system voltages greater than 480 V AC.

Communication of status conditions is compatible with a toggle handle and a rotary handle.

#### Communication of status indications and controls

This requires, in addition to the previous auxiliaries:

- 1 communicating motor mechanism connected to the BSCM.

#### Communication of measurements

Available on MicroLogic 5 / 6 / 7, the system consists of:

- 1 NSX cord (internal terminal block) for both communication and 24 V DC supply to the MicroLogic.

Communication of measurements is compatible with a standard or communicating motor mechanism and a rotary handle.

#### Communication of status indications, controls and measurements

Available on MicroLogic 5 / 6 / 7, the system consists of:

- 1 BSCM module
- 1 NSX cord (internal terminal block) for both communication and 24 V DC supply to the BSCM and the MicroLogic
- 1 communicating motor mechanism connected to the BSCM.

#### Installation of SDx or SDTAM is compatible with communication.

The following table indicates auxiliary possibilities depending on the type of trip unit.



### NA, TMD, TMG, MA, MicroLogic 2 / 4

#### Communication of status indications

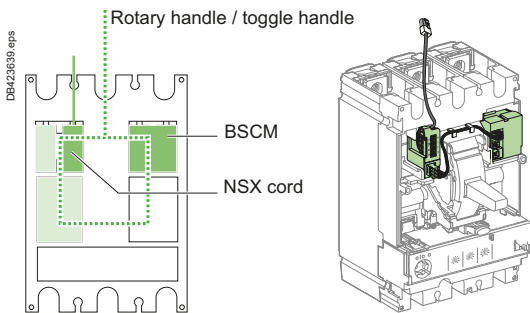

or

#### Communication of status indications and controls

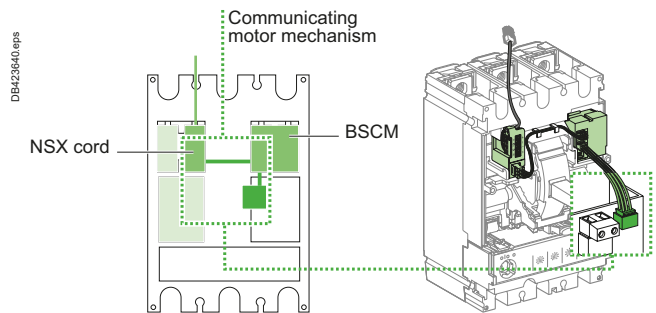

### MicroLogic 5 / 6 / 7

#### Communication of measurements with or without FDM121 display

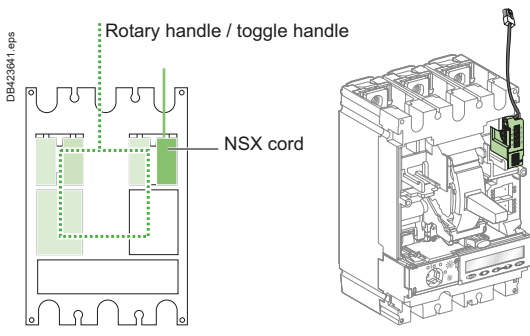

or

#### Communication of status indications, controls and measurements with or without FDM121 display

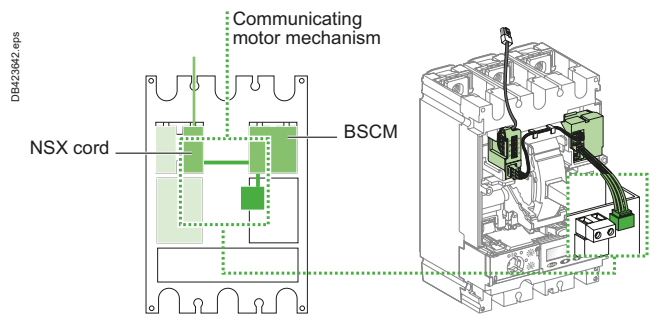

# ComPact NSX accessories and auxiliaries

## Selection of auxiliaries

### Standard

All ComPact NSX400/630 circuit breakers and switch-disconnectors have slots for the electrical auxiliaries listed below.

**7 indication contacts** (see page C-30)

- 4 ON/OFF (OF1, OF2, OF3, OF4)
- 1 trip indication (SD)
- 1 fault-trip indication (SDE)
- 1 earth-fault indication (SDV), when the device is equipped with a Vigi add-on.

**1 remote-tripping release** (see page C-33)

- either 1 MN undervoltage release
- or 1 MX shunt release.

### Remote indications

Circuit breakers equipped with MicroLogic trip units may be equipped with a fault-trip indication to identify the type of fault by installing:

**1 indication module with two outputs** (see page C-31)

- either an SDx module with MicroLogic 2.3 / 4.3 / 5.3 A or E / 6.3 A or E or 7 E
- or an SDTAM module with MicroLogic 2.3 M or 6-3 E-M (motor protection).

This module occupies the slots of an MN/MX release.

**All these auxiliaries may be installed with a motor mechanism or a rotary handle or a toggle handle.**

The following table indicates auxiliary possibilities depending on the type of trip unit.

## NA, MicroLogic 1.3 M

### Standard

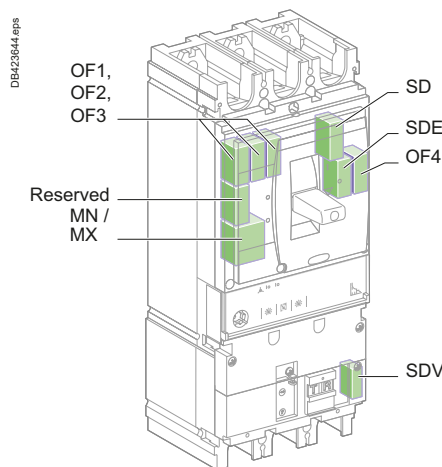
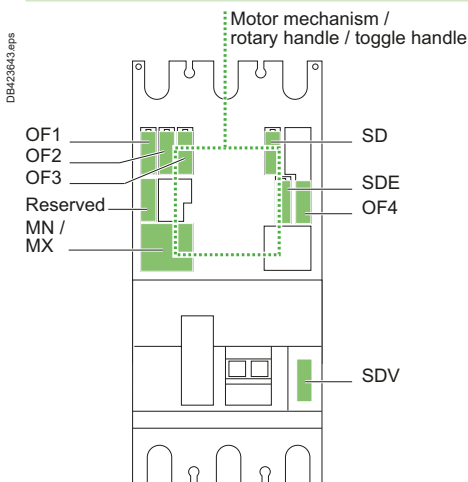

## MicroLogic 2 / 4 / 5 / 6 / 7

### Standard

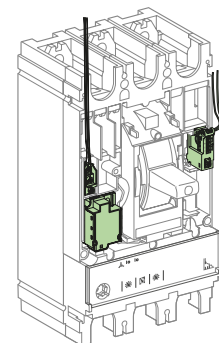
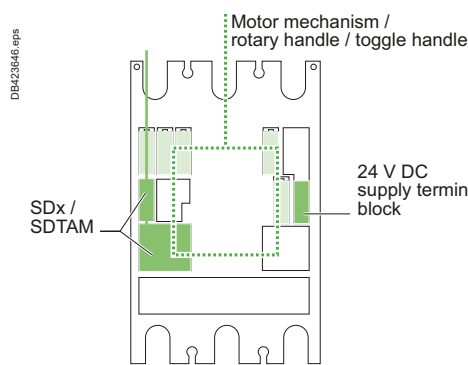
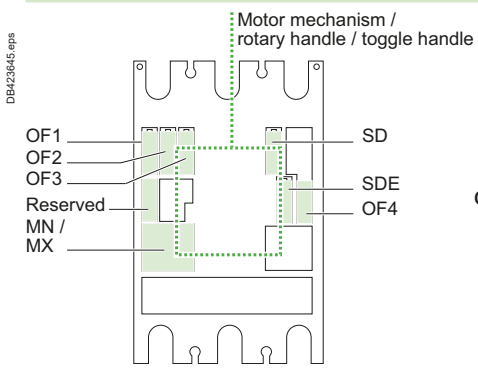

The SDx or SDTAM uses the reserved slot and the MN/MX slots.

External connection is made via a terminal block in the reserved slot.

The 24 V DC supply provides for the MicroLogic 5 / 6 / 7 display when the device is OFF or under low-load conditions.



# Customize your circuit breaker with accessories

## ComPact NSX accessories and auxiliaries

### Selection of auxiliaries

#### Communication

Communication requires specific auxiliaries.

##### Communication of status indications

- 1 BSCM module
- 1 NSX cord (internal terminal block) for both communication and 24 V DC supply to the BSCM. The insulated NSX cord is mandatory for system voltages greater than 480 V AC.

■ Communication of status conditions is compatible with a toggle handle and a rotary handle.

##### Communication of status indications and controls

This requires, in addition to the previous auxiliaries:

- 1 communicating motor mechanism connected to the BSCM.

##### Communication of measurements

Available on MicroLogic 5 / 6 / 7, the system consists of:

- 1 NSX cord (internal terminal block) for both communication and 24 V DC supply to the MicroLogic.

■ Communication of measurements is compatible with a standard or communicating motor mechanism and a rotary handle.

##### Communication of status indications, controls and measurements

Available on MicroLogic 5 / 6 / 7, the system consists of:

- 1 BSCM module
- 1 NSX cord (internal terminal block) for both communication and 24 V DC supply to the BSCM and the MicroLogic
- 1 communicating motor mechanism connected to the BSCM.

##### Installation of SDx or SDTAM is compatible with communication.

The following table indicates auxiliary possibilities depending on the type of trip unit.



#### NA, MicroLogic 1.3 M, MicroLogic 2 / 4

##### Communication of status indications

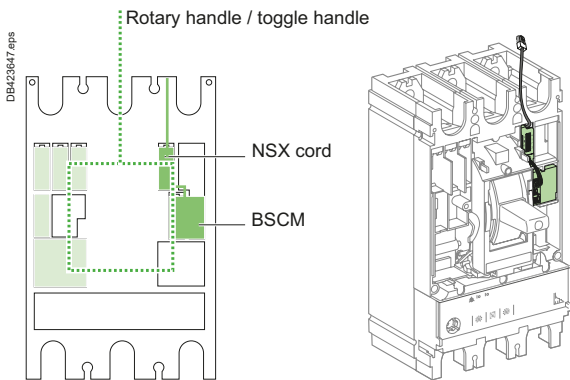

##### Communication of status indications and controls

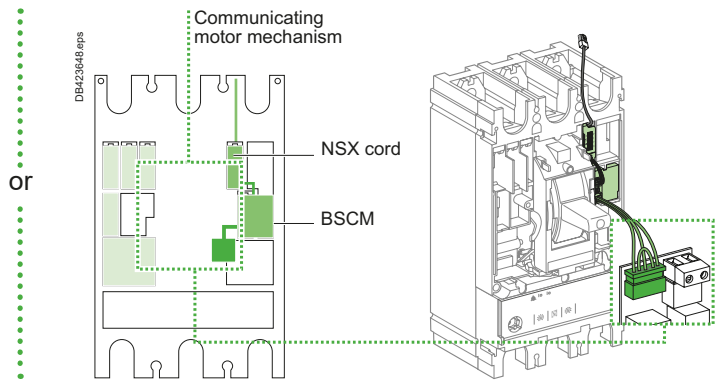

#### MicroLogic 5 / 6 / 7

##### Communication of status indications

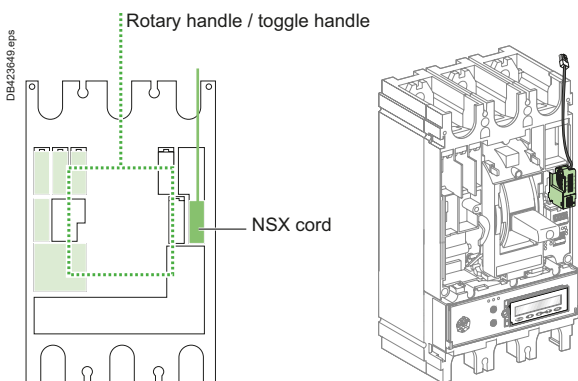

##### Communication of status indications, controls and measurements with or without FDM121 display

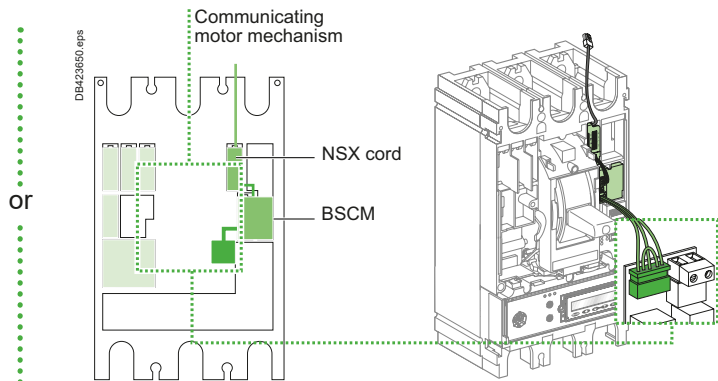

# ComPact NSX accessories and auxiliaries

## Connection of electrical auxiliaries

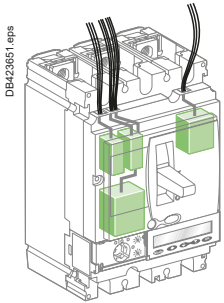

DB423651.eps

Fixed ComPact NSX.

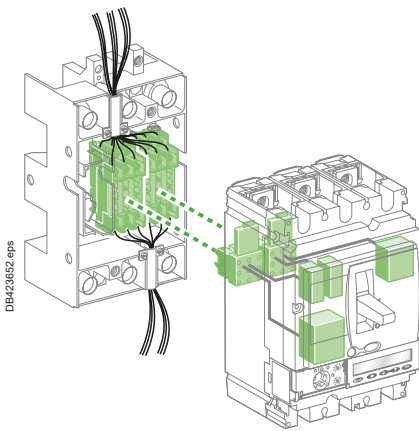

DB423652.eps

Plug-in/withdrawable ComPact NSX.

### Fixed ComPact NSX

Auxiliary circuits exit the device through a knock-out in the front cover.

### Withdrawable or plug-in ComPact NSX

#### Automatic auxiliary connectors

Auxiliary circuits exit the circuit breaker via one to three automatic auxiliary connectors (nine wires each). These are made up of:

- a moving part, connected to the circuit breaker via a support (one support per circuit breaker)
- a fixed part, mounted on the plug-in base, equipped with connectors for bare cables up to 2.5 mm<sup>2</sup>.

MicroLogic trip unit options are also wired via the automatic auxiliary connectors.

#### Selection of automatic auxiliary connectors

Depending on the functions installed, one to three automatic auxiliary connectors are required.

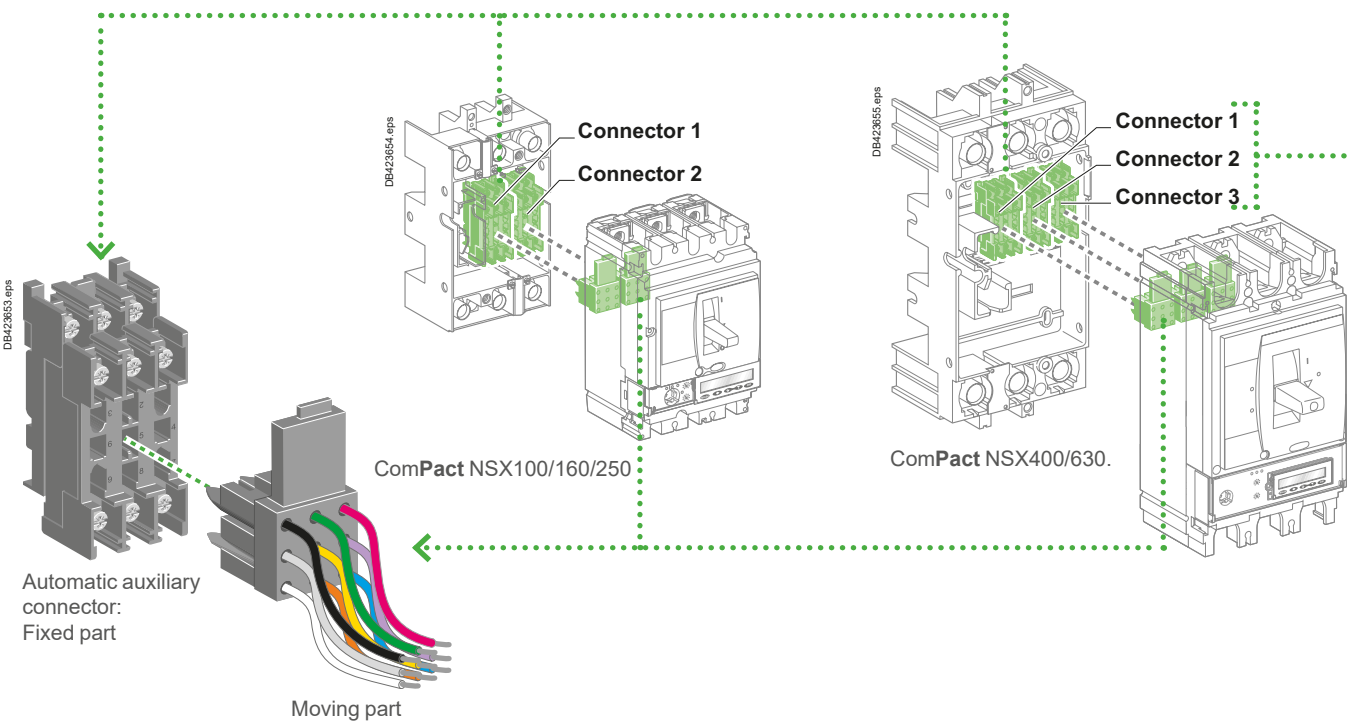

# Customize your circuit breaker with accessories

## ComPact NSX accessories and auxiliaries

### Connection of electrical auxiliaries

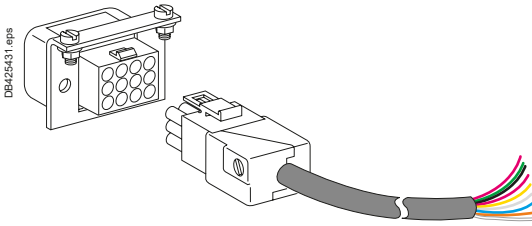

Nine-wire manual auxiliary connector.

### Withdrawable ComPact NSX

#### Manual auxiliary connectors

As an option to the automatic auxiliary connectors, withdrawable circuit breakers may be equipped with one to three plugs with nine wires each. In "disconnected" position, the auxiliaries remain connected. They can then be tested by operating the device.

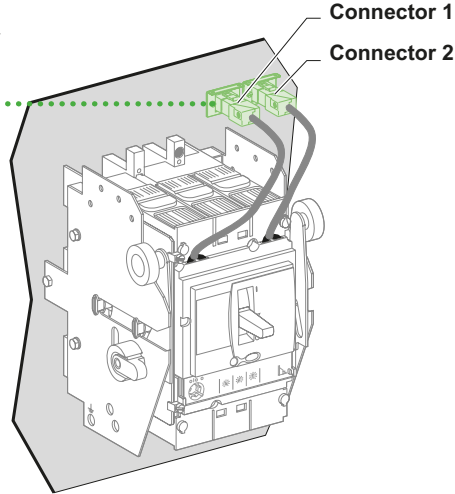

ComPact NSX100/160/250.

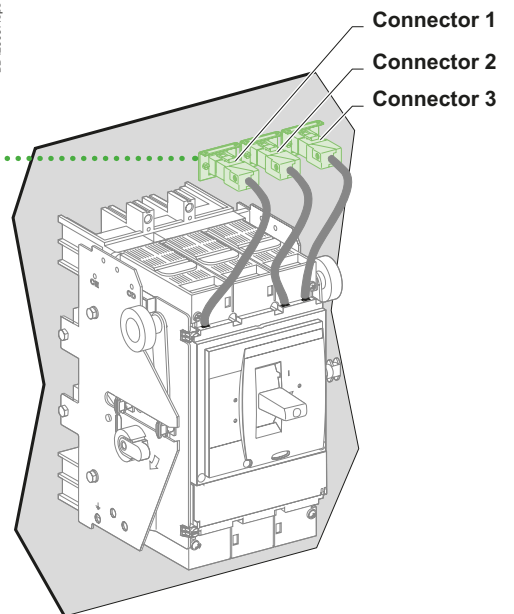

ComPact NSX400/630.

Each auxiliary is equipped with a terminal block with numbered terminals for connection of wires up to:

- 1.5 mm<sup>2</sup> for auxiliary contacts and voltage releases
- 2.5 mm<sup>2</sup> for the motor-mechanism module.

Circuit breaker	Connector 1	Connector 2	Connector 3
	OF1 MN/MX or SDx/ SD or SDTAM	OF2/SDV / ZSI out <sup>(1)</sup> SDE NSX cord MT MTc 24 V DC	OF3 OF4 ZSI in ZSI out
NSX100/160/250	●	●	-
NSX400/630	●	●	●

[1] Only for NSX100 to 250.

**MT**: motor mechanism.

**MTc**: communicating motor mechanism.



# ComPact NSX accessories and auxiliaries

## Indication contacts

One contact model provides circuit-breaker status indications (OF - SD - SDE - SDV).  
 An early-make or early-break contact, in conjunction with a rotary handle, can be used to anticipate device opening or closing.  
 A CE / CD contact indicates that the chassis is connected / disconnected.



Indication contacts.



CE/CD carriage switches.

These common-point changeover contacts provide remote circuit-breaker status information.  
 They can be used for indications, electrical locking, relaying, etc.  
 They comply with the IEC 60947-5 international standards.

### Functions

#### Breaker-status indications, during normal operation or after a fault

A single type of contact provides all the different indication functions:

- OF (ON/OFF) indicates the position of the circuit breaker contacts
- SD (trip indication) indicates that the circuit breaker has tripped due to:
  - an overload
  - a short-circuit
  - an earth fault (Vigi) or a ground fault (MicroLogic 6)
  - operation of a voltage release
  - operation of the "push to trip" button
  - disconnection when the device is ON.

The SD contact returns to de-energised state when the circuit breaker is reset.

- SDE (fault-trip indication) indicates that the circuit breaker has tripped due to:
  - an overload
  - a short-circuit
  - an earth fault (Vigi) or a ground fault (MicroLogic 6).

The SD contact returns to de-energised state when the circuit breaker is reset.

- SDV indicates that the circuit breaker has tripped due to an earth fault. It returns to de-energised state when the Vigi add-on is reset.

All the above auxiliary contacts are also available in "low-level" versions capable of switching very low loads (e.g. for the control of PLCs or electronic circuits).

#### Rotary-handle position contact for early-make or early-break functions

- CAM (early-make or early-break function) contacts indicate the position of the rotary handle.

They are used in particular for advanced opening of safety trip devices (early break) or to energise a control device prior to circuit-breaker closing (early make).

#### Chassis-position contacts

- CE/CD (connected/disconnected) contacts are microswitch-type carriage switches for withdrawable circuit breakers.

### Installation

- OF, SD, SDE and SDV functions: a single type of contact provides all these different indication functions, depending on where it is inserted in the device. The contacts clip into slots behind the front cover of the circuit breaker (or the Vigi add-on for the SDV function).

The SDE function on a ComPact NSX100 - 250 A equipped with a magnetic, thermal-magnetic or MicroLogic 2 trip unit requires the SDE actuator.

- CAM function: the contact fits into the rotary-handle unit (direct or extended).
- CE/CD function: the contacts clip into the fixed part of the chassis.

### Electrical characteristics of auxiliary contacts

Contacts		Standard				Low level			
Types of contacts		All				OF, SD, SDE, SDV			
Rated thermal current (A)		6				5			
Minimum load		100 mA at 24 V DC				1 mA at 4 V DC			
Utilisation cat. (IEC 60947-5-1)		AC12	AC15	DC12	DC14	AC12	AC15	DC12	DC14
Operational current (A)	24 V AC/DC	6	6	6	1	5	3	5	1
	48 V AC/DC	6	6	2.5	0.2	5	3	2.5	0.2
	110 V AC/DC	6	5	0.6	0.05	5	2.5	0.6	0.05
	220/240 V AC	6	4	-	-	5	2	-	-
	250 V DC	-	-	0.3	0.03	5	-	0.3	0.03
	380/440 V AC	6	2	-	-	5	1.5	-	-
	480 V AC	6	1.5	-	-	5	1	-	-
660/690 V AC	6	0.1	-	-	-	-	-	-	

# Customize your circuit breaker with accessories

## ComPact NSX accessories and auxiliaries

### SDx and SDTAM

### SDx module

The SDx module removes the trip or alarm conditions of ComPact NSX circuit breakers equipped with electronic protection.

The SD2 output, available on all MicroLogic trip units, corresponds to the overload-trip indication.

The SD4 output, available on MicroLogic 5 / 6 / 7, is assigned to:

- MicroLogic 5: overload (Ir)
- MicroLogic 6: overload (Ir) and ground fault (Ig)
- MicroLogic Vigi 7E: overload (Ir) and earth leakage fault (IΔn).

These two outputs automatically reset when the device is closed (turned ON). For MicroLogic 5 / 6 / 7, the SD2 and SD4 outputs can be reprogrammed to be assigned to other types of tripping or alarm.

#### Output characteristics

It is possible to assign a function:

- latching with a time delay. Return to the initial state occurs at the end of the time delay
  - permanent latching. In this case, return to the initial state takes place via the communication function.
- Static outputs: 24 to 415 V AC / V DC; 80 mA max.

### SDTAM module

The SDTAM module is specifically for the motor-protection MicroLogic trip units 2.2 M, 2.3 M and 6.2 E-M, 6.3 E-M.

The SDTAM module, linked to the contactor controller, opens the contactor when an overload or other motor fault occurs, thus avoiding opening of the circuit breaker.

#### MicroLogic 2 M

The SD4 output opens the contactor 400 ms before normal circuit-breaker opening in the following cases:

- overload (long-time protection for the trip class)
- phase unbalance or phase loss.

The SD2 output serves to memorise contactor opening by SDTAM.

#### MicroLogic 6 E-M

The SD4 output opens the contactor 400 ms before normal circuit-breaker opening in the following cases:

- overload (long-time protection for the trip class)
- phase unbalance or phase loss
- locked rotor
- underload (undercurrent protection)
- long start.

The SD2 output serves to memorise contactor opening by SDTAM.

#### Output characteristics

Output reset can be:

- manual by a pushbutton included in the wiring diagram
- automatic after an adjustable time delay (1 to 15 minutes) to take into account the motor-cooling time.

Static outputs: 24 to 415 V AC / V DC; 80 mA max.

SDx and SDTAM are relay modules with two static outputs. They send different signals depending on the type of fault. They may not be used together.



SDx relay module with its terminal block.

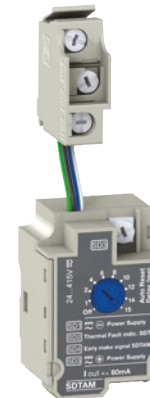

SDTAM relay module with its terminal block.

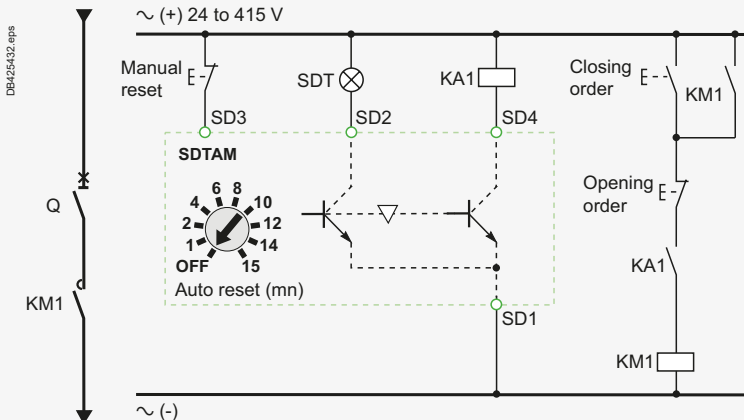

SDTAM wiring diagram with contactor control.

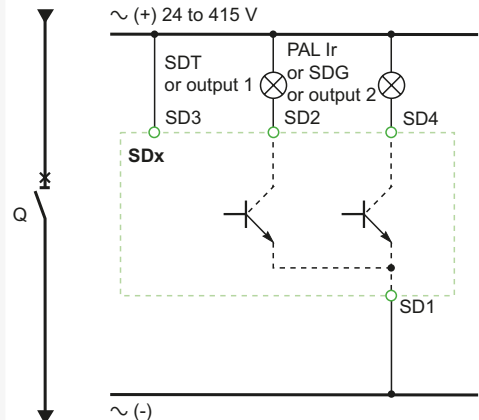

SDx wiring diagram.

# ComPact NSX accessories and auxiliaries

## Motor mechanism



ComPact NSX250 with motor mechanism.

When equipped with a **motor-mechanism** module, ComPact NSX circuit breakers feature very high mechanical endurance as well as easy and sure operation:

- all circuit-breaker indications and information remain visible and accessible, including trip-unit settings and indications
- suitability for isolation is maintained and padlocking remains possible
- double insulation of the front face.

A specific motor mechanism is required for operation via the communication function. This **communicating motor mechanism** must be connected to the BSCM module to receive the opening and closing orders. Operation is identical to that of a standard motor mechanism.

### Applications

- Local motor-driven operation, centralised operation, automatic distribution control.
- Normal/standby source changeover or switching to a replacement source to ensure availability or optimise energy costs.
- Load shedding and reconnection.
- Synchrocoupling.

### Operation

The type of operation is selected using the manual/auto mode selection switch (7). A transparent, lead-seal cover controls access to the switch.

#### Automatic

When the switch is in the "auto" position, the ON/OFF (I/O) buttons and the charging lever on the mechanism are locked.

- Circuit-breaker ON and OFF controlled by two impulse-type or maintained signals.
- Automatic spring charging following voluntary tripping (by MN or MX), with standard wiring.
- Mandatory manual reset following tripping due to an electrical fault.

#### Manual

When the switch is in the "manual" position, the ON/OFF (I/O) buttons may be used. A microswitch linked to the manual position can remote the information.

- Circuit-breaker ON and OFF controlled by 2 pushbuttons I/O.
- Recharging of stored-energy system by pumping the lever 8 times.
- Padlocking in OFF position.

### Installation and connections

All installation (fixed, plug-in/withdrawable) and connection possibilities are maintained.

Motor-mechanism module connections are made behind its front cover to integrated terminals, for cables up to 2.5 mm<sup>2</sup>.

### Optional accessories

- Keylock for locking in OFF position.
- Operations counter for the ComPact NSX400/630, indicating the number of ON/OFF cycles. Must be installed on the front of the motor-mechanism module.

### Characteristics

Motor mechanism		MT100 to MT630	
Response time (ms)	opening	< 700	
	closing	< 80	
Operating frequency	cycles/minute max.	4	
Control voltage (V)	DC	24/30 - 48/60 - 110/130 - 250	
	AC 50/60 Hz	48 (50 Hz) - 110/130 - 220/240 - 380/440	
Consumption <sup>[1]</sup>	DC (W)	opening	≤ 500
		closing	≤ 500
	AC (VA)	opening	≤ 500
		closing	≤ 500

[1] For NSX100 to NSX250, the inrush current is 2 In for 10 ms.

### Electrical endurance

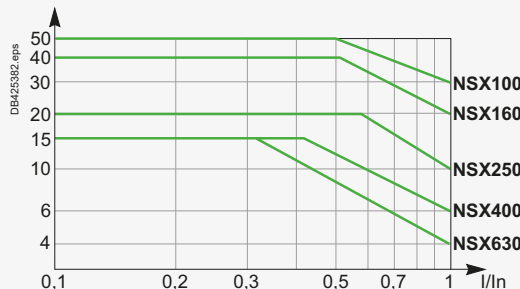

Circuit breaker + motor-mechanism module, in thousands of operations, at 440 V.

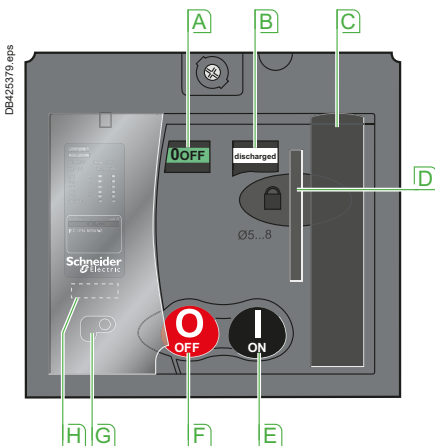

- A** Position indicator (positive contact indication)
- B** Spring status indicator (charged, discharged)
- C** Manual spring-charging lever
- D** Keylock device (optional)  
Locking device (OFF position), using 1 to 3 padlocks, shackle diameter 5 to 8 mm, not supplied
- E** I (ON) pushbutton
- F** O (OFF) pushbutton
- G** Manual/auto mode selection switch. The position of this switch can be indicated remotely.
- H** Operation counter (ComPact NSX400/630)

# Customize your circuit breaker with accessories

## ComPact NSX accessories and auxiliaries

### Remote tripping

MX or MN voltage releases are used to trip the circuit breaker. They serve primarily for remote, emergency-off commands. It is advised to test the system every six months.

#### MN undervoltage release

The MN release opens the circuit breaker when its supply voltage drops to a value below 35 % of its rated voltage  $U_n$ .

Undervoltage tripping, combined with an emergency-off button, provides fail-safe tripping. The MN release is continuously supplied, i.e. if supply is interrupted:

- either voluntarily, by the emergency-off button,
- or accidentally, through loss of power or faulty wiring, the release provokes opening of the circuit breaker.

#### Opening conditions

Circuit-breaker tripping by an MN release meets the requirements of standard IEC 60947-2.

- Automatic opening of the circuit breaker is ensured when the continuous voltage supply to the release  $U \leq 0.35 \times U_n$ .
- If the supply voltage is between 0.35 and 0.7  $U_n$ , opening is possible, but not guaranteed. Above 0.7  $U_n$ , opening does not take place.

#### Closing conditions

If there is no supply to the MN release, it is impossible to close the circuit breaker, either manually or electrically. Closing is ensured when the voltage supply to the release  $U \geq 0.85 \times U_n$ . Below this threshold, closing is not guaranteed.

#### Characteristics

Power supply	V AC	50/60 Hz: 24 - 48 - 100/130 - 200/240 50 Hz: 380/415    60 Hz: 208/277
	V DC	12 - 24 - 30 - 48 - 60 - 125 -250
Operating threshold	Opening	0.35 to 0.7 $U_n$
	Closing	0.85 $U_n$
Operating range		0.85 to 1.1 $U_n$
Consumption (VA or W)		Pick-up: 10 - Hold: 5
Response time (ms)		50

#### Time-delay unit for an MN release

A time delay unit for the MN release eliminates the risk of nuisance tripping due to a transient voltage dip. For shorter micro-outages, a system of capacitors provides temporary supply to the MN at  $U > 0.7$  to ensure non tripping.

The correspondence between MN releases and time-delay units is shown below.

Power supply	Corresponding MN release
<b>Unit with fixed delay 200 ms</b>	
48 V AC	48 V DC
220 / 240 V AC	250 V DC
<b>Unit with adjustable delay <math>\geq 200</math> ms</b>	
48 - 60 V AC/DC	48 V DC
100 - 130 V AC/DC	125 V DC
220 - 250 V AC/DC	250 V DC

#### MX shunt release

The MX release opens the circuit breaker via an impulse-type ( $\geq 20$  ms) or maintained order.

#### Opening conditions

When the MX release is supplied, it automatically opens the circuit breaker. Opening is ensured for a voltage  $U \geq 0.7 \times U_n$ .

#### Characteristics

Power supply	V AC	50/60 Hz: 24 - 48 - 100/130 - 200/240 50 Hz: 380/415    60 Hz: 208/277
	V DC	12 - 24 - 30 - 48 - 60 - 125 -250
Operating range		0.7 to 1.1 $U_n$
Consumption (VA or W)		Pick-up: 10
Response time (ms)		50

#### Circuit breaker control by MN or MX

When the circuit breaker has been tripped by an MN or MX release, it must be reset before it can be reclosed.

MN or MX tripping takes priority over manual closing.

In the presence of a standing trip order, closing of the contacts, even temporary, is not possible.

Connection using wires up to 1.5 mm<sup>2</sup> to integrated terminal blocks.



MX or MN voltage release.

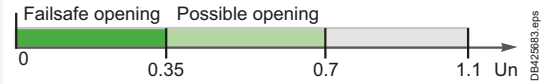

Opening conditions of the MN release.



Closing conditions of the MN release.



MN voltage release.

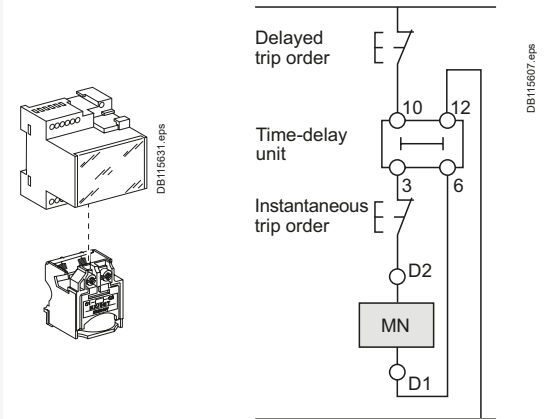

MN release with a time-delay unit.

Wiring diagram for emergency-off function with MN + time-delay unit.

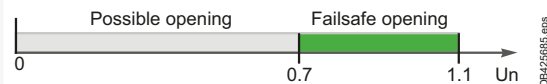

Opening conditions of the MX release.

**Note:** circuit breaker opening using an MN or MX release must be reserved for safety functions. This type of tripping increases wear on the opening mechanism. Repeated use reduces the mechanical endurance of the circuit breaker by 50 %.

# ComPact NSX accessories and auxiliaries

## Rotary handles

There are two types of rotary handle:

- direct rotary handle
- extended rotary handle.

There are two models:

- standard with a black handle
- red handle and yellow front for machine-tool control.



ComPact NSX with a rotary handle.



ComPact NSX with an MCC rotary handle.



ComPact NSX with a CNOMO machine-tool rotary handle.



ComPact NSX with an extended rotary handle installed at the back of a switchboard, with the keylock option and key.

### Direct rotary handle

#### Standard handle

Degree of protection IP40, IK07.

The direct rotary handle maintains:

- visibility of and access to trip-unit settings
- suitability for isolation
- indication of the three positions O (OFF), I (ON) and tripped
- access to the "push to trip" button.

#### Device locking

The rotary handle facilitates circuit-breaker locking.

- Padlocking:
  - standard situation, in the OFF position, using 1 to 3 padlocks, shackle diameter 5 to 8 mm, not supplied
  - with a simple modification, in the ON and OFF positions. Locking in the ON position does not prevent free circuit-breaker tripping if a fault occurs. In this case, the handle remains the ON position after the circuit breaker tripping. Unlocking is required to go to the tripped then the OFF position.
- Keylock (and padlock)

It is possible to install a Ronis or Profalux keylock (optional) on the base of the handle to obtain the same functions as with a padlock.

#### Early-make or early-break contacts (optional)

Early-make and/or early-break contacts may be used with the rotary handle. It is thus possible to:

- supply an MN undervoltage release before the circuit breaker closes
- open the contactor control circuit before the circuit breaker opens.

#### MCC switchboard control

Control of an MCC switchboard is achieved by adding a kit to the standard handle. In addition to the standard functions, the kit offers the characteristics listed below.

#### Higher degree of protection IP

Degree of protection IP43, IK07.

The IP is increased by a built-in gasket.

#### Door locking depending on device position

- The door cannot be opened if the circuit breaker is ON or in the tripped position.

For exceptional situations, door locking can be temporarily disabled with a tool to open the door when the circuit breaker is closed.

- Circuit-breaker closing is disabled if the door is open. This function can be deactivated.

#### Machine-tool control in compliance with CNOMO

Control of a machine-tool is achieved by adding a kit to the standard handle. In addition to the standard functions, the kit offers the characteristics listed below.

#### Enhanced waterproofness and mechanical protection

- Degree of protection IP54, IK08.
- Compliance with CNOMO E03.81.501N.

### Extended rotary handle

Degree of protection IP55, IK08.

The extended rotary handle makes it possible to operate circuit breakers installed at the back of switchboards, from the switchboard front.

It maintains:

- visibility of and access to trip-unit settings
- suitability for isolation
- indication of the three positions O (OFF), I (ON) and tripped.

#### Mechanical door locking when device closed

A standard feature of the extended rotary handle is a locking function, built into the shaft, that disables door opening when the circuit breaker is in the ON or tripped positions.

Door locking can be temporarily disabled with a tool to open the door without opening the circuit breaker. This operation is not possible if the handle is locked by a padlock.

#### Voluntary disabling of mechanical door locking

A modification to the handle, that can be carried out on site, completely disables door locking, including when a padlock is installed on the handle. The modification is reversible.

When a number of extended rotary handles are installed on a door, this disabling function is the means to ensure door locking by a single device.



# Customize your circuit breaker with accessories

## ComPact NSX accessories and auxiliaries

### Rotary handles

#### Extended rotary handle (cont.)

##### Operation when door is opened

An open door shaft operator can be used to operate the circuit breaker when door is opened. This accessory complies with UL508.

The indication of the three positions OFF (O), ON (I) and tripped (Trip) is visible on the circuit breaker.

##### Device and door padlocking

Padlocking locks the circuit-breaker handle and disables door opening:

- standard situation, in the OFF position, using 1 to 3 padlocks, shackle diameter 5 to 8 mm, not supplied
- with a simple modification, in the ON and OFF positions. Locking in the ON position does not prevent free circuit-breaker tripping if a fault occurs. In this case, the handle remains in the ON position after the circuit breaker tripping. Unlocking is required to go to the tripped then the OFF position.

If the door controls were modified to voluntarily disable door locking, padlocking does not lock the door, but does disable handle operation of the device.

##### Device locking using a keylock inside the switchboard

It is possible to install a Ronis or Profalux keylock (optional) on the base of the rotary handle to lock the device in the OFF position or in either the ON or OFF positions.

##### Accessory for device operation with the door open

When the device is equipped with an extended rotary handle, a control accessory mounted on the shaft makes it possible to operate the device with the door open.

- The device can be padlocked in the OFF position.
- The accessory complies with UL508.

##### Early-make or early-break contacts (optional)

The extended rotary handle offers the same possibilities with early-make and/or early-break contacts as the standard rotary handle.

##### Parts of the extended rotary handles

- A unit that replaces the front cover of the circuit breaker (secured by screws).
- An assembly (handle and front plate) on the door that is always secured in the same position, whether the circuit breaker is installed vertically or horizontally.
- An extension shaft that must be adjusted to the distance. The min/max distance between the back of circuit breaker and door is:
  - 185...600 mm for ComPact NSX100 to 250
  - 209...600 mm for ComPact NSX400/630.

For withdrawable devices, the extended rotary handle is also available with a telescopic shaft to compensate for device disconnection. In this case, the min/max distances are:

- 248...600 mm for ComPact NSX100 to 250
- 272...600 mm for ComPact NSX400/630.

#### Manual source-changeover systems

An additional accessory interlocks two devices with rotary handles to create a source-changeover system. Closing of one device is possible only if the second is open.

This function is compatible with direct or extended rotary handles.

Up to three padlocks can be used to lock in the OFF or ON position.



# ComPact NSX accessories and auxiliaries

## Manual and Automatic Transfer Switch

Schneider Electric offers source change-over systems based on ComPact and MasterPact devices. They are made of up to 3 circuit breakers or switch-disconnectors linked by an electrical interlocking system that may have different configurations. Moreover, a mechanical interlocking system must be added to protect against electrical malfunctions or incorrect manual operations. In addition, a controller can be used for automatically control the source transfer. The following pages present the different solutions for mechanical and electrical interlocking and associated controllers.

# M

## Manual source-changeover system

(or MTSE: Manual Transfer Switching Equipment)

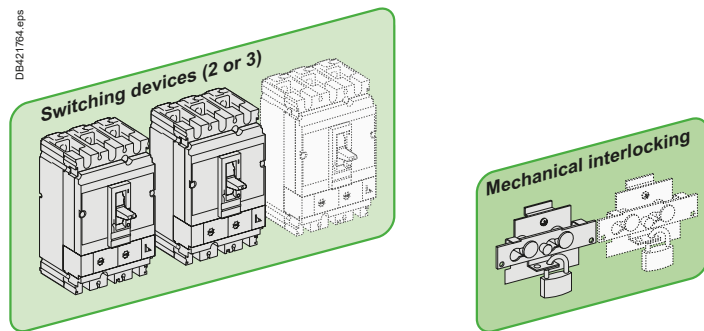

# R/A

## Remote-operated source-changeover system

(or RTSE: Remote Transfer Switching Equipment)

## Automatic source-changeover system

(or ATSE: Automatic Transfer Switching Equipment)

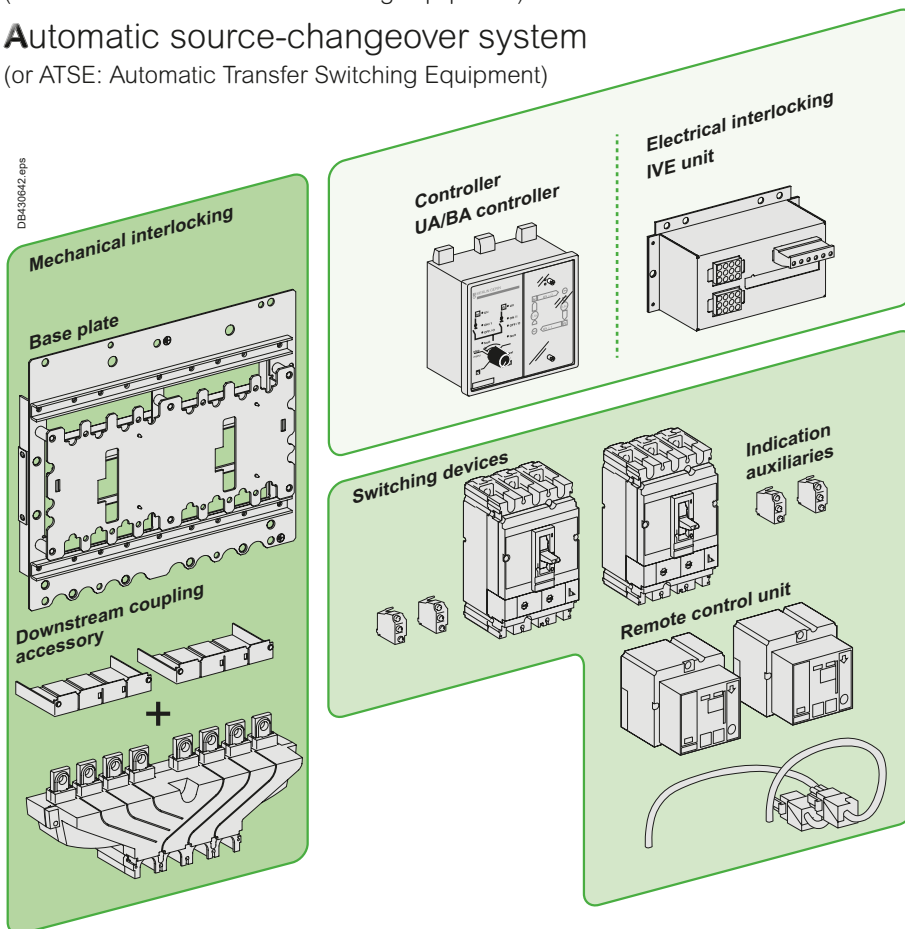

# Customize your circuit breaker with accessories

## ComPact NSX accessories and auxiliaries

### Mechanical interlocking

#### Interlocking of two or three toggle-controlled devices

##### Interlocking system

Two devices can be interlocked using this system. Two identical interlocking systems can be used to interlock three devices installed side by side.

Authorised positions:

- one device closed (ON), the others open (OFF)
- all devices open (OFF).

The system is locked using one or two padlocks (shackle Ø5 to 8 mm).

This system can be expanded to more than three devices.

There are two interlocking-system models:

- one for ComPact INS/INV
- one for ComPact NSX100 to NSX250
- one for ComPact NSX400 to NSX630.

##### Combinations of Normal and Replacement devices

All toggle-controlled fixed or plug-in ComPact NSX100 to NSX630 circuit breakers and switch-disconnectors of the same frame size can be interlocked. The devices must be either all fixed or all plug-in versions.

#### Interlocking of two devices by rotary handles

##### Interlocking system

Interlocking involves padlocking the rotary handles on two devices which may be either circuit breakers or switch-disconnectors.

Authorised positions:

- one device closed (ON), the other open (OFF)
- both devices open (OFF).

The system is locked using up to three padlocks (shackle Ø5 to 8 mm).

There are two interlocking-system models:

- one for ComPact INS/INV
- one for ComPact NSX100 to NSX250
- one for ComPact NSX400 to NSX630.

##### Combinations of Normal and Replacement devices

All rotary-handle fixed or plug-in ComPact NSX100 to NSX630 circuit breakers and switch-disconnectors of the same frame size can be interlocked. The devices must be either all fixed or all plug-in versions.

#### Interlocking of two devices by base plate

##### Interlocking system

A base plate designed for two ComPact NSX devices can be installed horizontally or vertically on a mounting rail. Interlocking is carried out on the base plate by a mechanism located behind the devices. In this way, access to the device controls and trip units is not blocked.

##### Combinations of Normal and Replacement devices

All rotary-handle and toggle-controlled ComPact NSX100 to NSX630 circuit breakers and switch-disconnectors can be interlocked. Devices must be either all fixed or all plug-in versions, with or without earth-leakage protection or measurement modules.

An adaptation kit is required to interlock:

- two plug-in devices
- a ComPact NSX100 to NSX250 with an NSX400 to NSX630.

Connection to the downstream installation can be made easier using a coupling accessory.

#### Interlocking of devices by keylocks (captive keys)

Interlocking using keylocks is very simple and makes it possible to interlock two or more devices that are physically distant or that have very different characteristics, for example medium-voltage and low-voltage devices or a ComPact NSX100 to NSX630 switch-disconnector and circuit breaker.

##### Interlocking system

Each device is equipped with an identical keylock and the key is captive on the closed (ON) device. A single key is available for all devices. It is necessary to first open (OFF position) the device with the key before the key can be withdrawn and used to close another device.

A system of wall-mounted captive key boxes makes a large number of combinations possible between many devices.

##### Combinations of Normal and Replacement devices

All rotary-handle ComPact NSX100 to NSX630 circuit breakers and switch-disconnectors can be interlocked between each other or with any other device equipped with the same type of keylock.

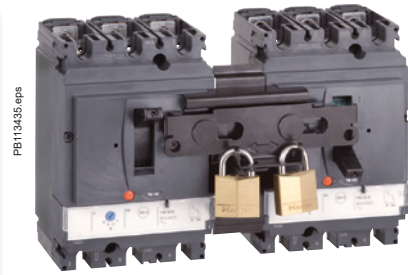

Interlocking of two or three toggle-controlled devices.

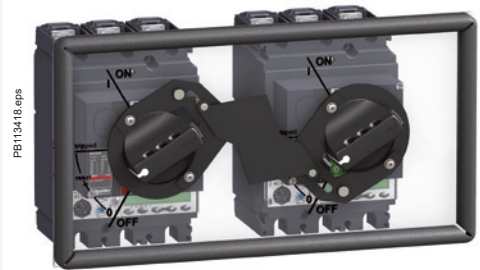

Interlocking of two devices by rotary handles.



Interlocking on a base plate.

> TransferPact  
(source-changeover systems)



LVPED216028EN

# ComPact NSX accessories and auxiliaries

## Mechanical and electrical interlocking for source-changeover systems



PE113419.eps

Remote-operated source-changeover system.

- A** Circuit breaker QS1 equipped with a motor mechanism and auxiliary contacts, connected to the N source
- B** Circuit breaker QS2 equipped with a motor mechanism and auxiliary contacts, connected to the R source
- C** Base plate with mechanical interlocking
- D** Electrical interlocking unit IVE
- E** Coupling accessory (downstream connection)

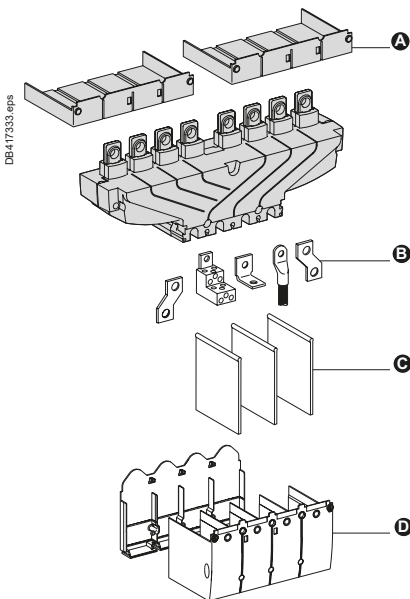

DB417333.eps

- A** Short terminal shields
- B** Terminals
- C** Interphase barriers
- D** Long terminal shields

It is made up of two devices with motor mechanisms, mounted on a base plate and combined with:

- an electrical interlocking unit
- optional mechanical interlocking system.

### Electrical interlocking unit (IVE)

Interlocks two devices equipped with motor mechanisms and auxiliary contacts. The IVE unit is mandatory to ensure the necessary time-delays required for safe switching.

### Mechanical interlocking system

The mechanical interlocking system is strongly recommended to limit the effects of design or wiring errors and to avoid manual switching errors.

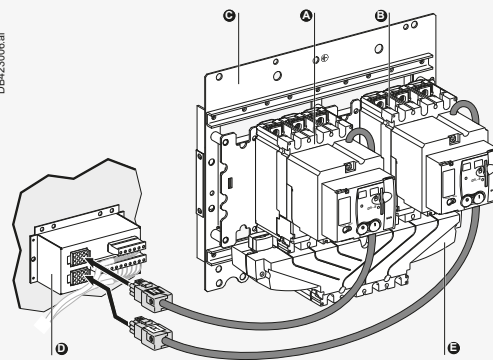

DB423006.ai

### Downstream coupling accessory

This accessory simplifies connection to bars and cables with lugs. It may be used to couple two circuit breakers of the same size.

Pitch between outgoing terminals:

- ComPact NSX100 to NSX250: 35 mm
- ComPact NSX400 to NSX630: 45 mm.

For ComPact NSX circuit breakers, the downstream coupling accessory can be used only with **fixed versions**.

### Connection and insulation accessories

The coupling accessory can be fitted with the same connection and insulation accessories as the circuit breakers.

Possible uses	Downstream coupling	
	Possible mounting	Outgoing pitch (mm)
<b>Remote-operated source-changeover systems</b>		
NSX100 to NSX250	●	35
NSX400 to NSX630	●	45

# ComPact NSX accessories and auxiliaries

## Automatic source-changeover systems with controller

By combining a remote-operated source-changeover system with an integrated BA or UA automatic controller, it is possible to automatically control source transfer according to user-selected sequences. These controllers can be used on source-changeover systems comprising 2 circuit breakers. For source-changeover systems comprising 3 circuit breakers, the automatic control diagram must be prepared by the installer as a complement to diagrams provided in the “electrical diagrams” section of the catalog source-changeover systems.



BA controller.



UA controller.

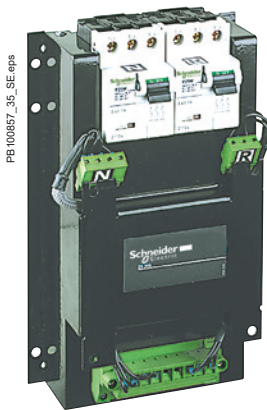

TransferPact ACP control plate.

### Functions of the BA and UA controllers

Controller		BA	UA				
Compatible circuit breakers		ComPact NSX100 to 630 circuit breakers					
<b>4-position switch</b>							
Automatic operation		<input checked="" type="radio"/>	<input checked="" type="radio"/>				
Forced operation on Normal source		<input checked="" type="radio"/>	<input checked="" type="radio"/>				
Forced operation on Replacement source		<input checked="" type="radio"/>	<input checked="" type="radio"/>				
Stop (both Normal and Replacement sources OFF)		<input checked="" type="radio"/>	<input checked="" type="radio"/>				
<b>Automatic operation</b>							
Monitoring of the Normal source and automatic transfer from one source to the other		<input checked="" type="radio"/>	<input checked="" type="radio"/>				
Engine generator set start-up control			<input checked="" type="radio"/>				
Delayed shutdown (adjustable) of engine generator set			<input checked="" type="radio"/>				
Load shedding and reconnection of non-priority loads			<input checked="" type="radio"/>				
Transfer to Replacement source if one of the Normal source phases is absent			<input checked="" type="radio"/>				
<b>Test</b>							
By opening the P25M circuit breaker upstream of the controller		<input checked="" type="radio"/>					
By pressing the test button on the front of the controller			<input checked="" type="radio"/>				
<b>Indications</b>							
Circuit-breaker status indication on the front of the controller: ON, OFF, fault trip		<input checked="" type="radio"/>	<input checked="" type="radio"/>				
Automatic-mode indication contact		<input checked="" type="radio"/>	<input checked="" type="radio"/>				
<b>Other functions</b>							
Selection of type of Normal source (single-phase or three-phase)			<input checked="" type="radio"/>				
Voluntary transfer to Replacement source		<input checked="" type="radio"/>	<input checked="" type="radio"/>				
Forced operation on Normal source if Replacement source is not operational			<input checked="" type="radio"/>				
Additional test contact (not part of controller)		<input checked="" type="radio"/>	<input checked="" type="radio"/>				
Transfer to Replacement source only if contact closed (e.g. for a UR frequency check)		<input checked="" type="radio"/>	<input checked="" type="radio"/>				
Setting of maximum start-up time for the Replacement-source			<input checked="" type="radio"/>				
<b>Power supply</b>							
Control voltages <sup>[1]</sup>	220 to 240 V 50/60 Hz	<input checked="" type="radio"/>	<input checked="" type="radio"/>				
	380 to 415 V 50/60 Hz	<input checked="" type="radio"/>	<input checked="" type="radio"/>				
	440 V 60 Hz	<input checked="" type="radio"/>	<input checked="" type="radio"/>				
<b>Operating thresholds</b>							
Undervoltage	0.35 Un ≤ voltage ≤ 0.7 Un	<input checked="" type="radio"/>	<input checked="" type="radio"/>				
Phase failure	0.5 Un ≤ voltage ≤ 0.7 Un		<input checked="" type="radio"/>				
Voltage presence	voltage ≥ 0.85 Un	<input checked="" type="radio"/>	<input checked="" type="radio"/>				
<b>Characteristics of output contacts (dry, volt-free contacts)</b>							
Rated thermal current (A)	8						
Minimum load	10 mA at 12 V						
		<b>AC</b>				<b>DC</b>	
Utilisation category (IEC 60947-5-1)		AC12	AC13	AC14	AC15	DC12	DC13
Operational current (A)	24 V	8	7	5	6	8	2
	48 V	8	7	5	5	2	-
	110 V	8	6	4	4	0.6	-
	220/240 V	8	6	4	3	-	-
	250 V	-	-	-	-	0.4	-
	380/415 V	5	-	-	-	-	-
440 V	4	-	-	-	-	-	
660/690 V	-	-	-	-	-	-	

[1] The controller is powered by the ACP control plate. The same voltage must be used for the ACP plate, the IVE unit and the circuit-breaker operating mechanisms. If this voltage is the same as the source voltage, then the “Normal” and “Replacement” sources can be used directly for the power supply. If not, an isolation transformer must be used.



# ComPact NSX accessories and auxiliaries

## Additional measurement module: PowerLogic PowerTag NSX

PowerTag NSX is a ComPact NSX wireless-communication modules for 3P and 3P+N electrical networks, mounted directly on the bottom side of the circuit breaker or the Vigi add-on. PowerTag NSX provides capability to measure energy, monitor voltage loss, and trigger alarms. It then delivers useful data for monitoring and diagnosis of the associated circuit breaker to a concentrator.

In combination with PowerTag Acti9, you can take advantage of a full wireless class 1 solution to monitor energy and to be aware in case of voltage loss or alarming at any level of a distribution panel, being able to take immediately the right actions in case of electrical issue. In addition to monitoring and alarming, PowerTag solution provides a complete knowledge of real time electrical values with a rich and accurate data transfer every 5 seconds.

PowerTag energy sensors can be quickly and easily installed in new or existing panels at any time. Compared to traditional metering solutions, installation time and commissioning are much shorter with no wiring, hence an error proof high density solution and a built-in class 1 accuracy.



PowerLogic PowerTag NSX.

### Functions

PowerTag NSX energy sensor measures the following values in accordance with the IEC 61557-12 standard:

- Energy (4 quadrants):
  - Active energy (kWh): total and partial, delivered and received.
  - Active energy per phase (kWh): total.
  - Reactive energy (VARh): partial, delivered and received.
- Power:
  - Active power (W): total and per phase
  - Reactive power (VAR): total
  - Apparent power (VA): total.
- Voltages (V): phase-to-phase (U12, U23, U31) and phase-to-neutral (V1N, V2N, V3N)
- Currents (A): per phase (I1, I2, I3)
- Frequency
- Power factor
- Voltage loss alarm:
  - PowerTag energy sensor sends a "voltage loss" alarm and the current-per-phase value before being de-energized,
  - At "voltage loss", PowerTag adds an overload alarm if the current is higher than the rated current of the associated protective device.

### Installation

The module is self-powered and is installed for fixed devices directly on the bottom side of the circuit breaker or Vigi add-on terminals. For plug-in devices, it has to be installed on the base itself.

PowerTag NSX 3P has to be used with 3P devices, and an external neutral voltage tap is provided in case of the installation has a neutral to provide phase-to-neutral voltages, active energy per phase and power per phase. PowerTag 3P+N has to be used with 4P devices.

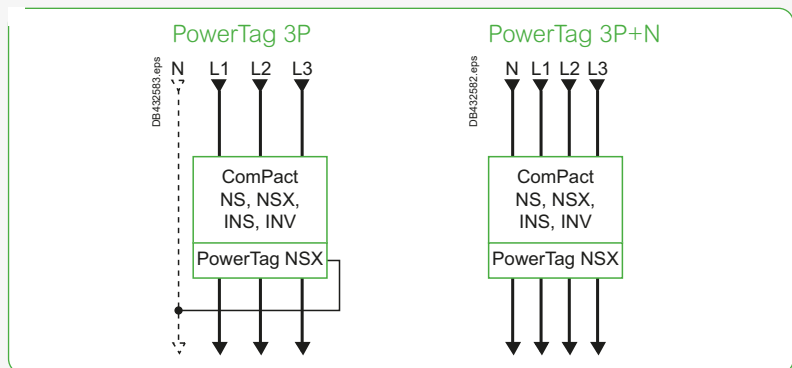

PowerTag NSX modules are compatible with ComPact NSX100/160/250, ComPact NSX400/630, ComPact INS250-100A to 250A, ComPact INS320/400/500/630, ComPact INV100/160/200/250, ComPact INV320/400/500/630, ComPact NS100/160/250 and ComPact NS400/630.

In case of retrofit, following points have to be checked:

- Clearance to be able to add PowerTag module (see dimensions in chapter E) and to respect bending radius of cables
- Condition of power connectors: to be replaced if damaged
- Tightening torques depending of the connector used

# ComPact NSX accessories and auxiliaries

## Additional measurement module: PowerLogic PowerTag NSX



 How to Install PowerTag in Your Existing Panel

 How to Commission Your PowerTag

 Introducing PowerTag® The Smallest Wireless Energy Sensor Available

### Integration in concentrator

PowerTag Link concentrate wirelessly data from PowerTag and make them available over Ethernet:

For Commercial & Building applications		
PowerTag Link (Monitoring)	PowerTag Link HD (Monitoring)	Smartlink SI B (Monitoring & Control)
		
<b>A9XMWD20</b>	<b>A9XMWD100</b>	<b>A9XMZA08</b>

For Small Business applications
PowerTag Link C (Monitoring)

<b>A9XELC10</b>

Concentrator embedded web pages allow:

- to do commissioning
- to display measured values
- to set and display alarms and pre-alarms.

PowerTag NSX is also compatible with Wiser Energy (Residential). Refer to the concentrator catalogs for more information.

### Commissioning

Commissioning can be done very easily:

- for PowerTag Link C: with a smartphone
- for PowerTag Link, PowerTag Link HD and Smartlink SI B: with embedded webpages or with EcoStruxure Power Commission which provides a test report for system integration with all the Modbus registers, including bits and descriptions associated.



# ComPact NSX accessories and auxiliaries

## Additional measurement module: PowerLogic PowerTag NSX



### Metering and monitoring

PowerTag Link / PowerTag Link HD (Ethernet)

### Metering, monitoring and control

Smartlink SI B (Ethernet)

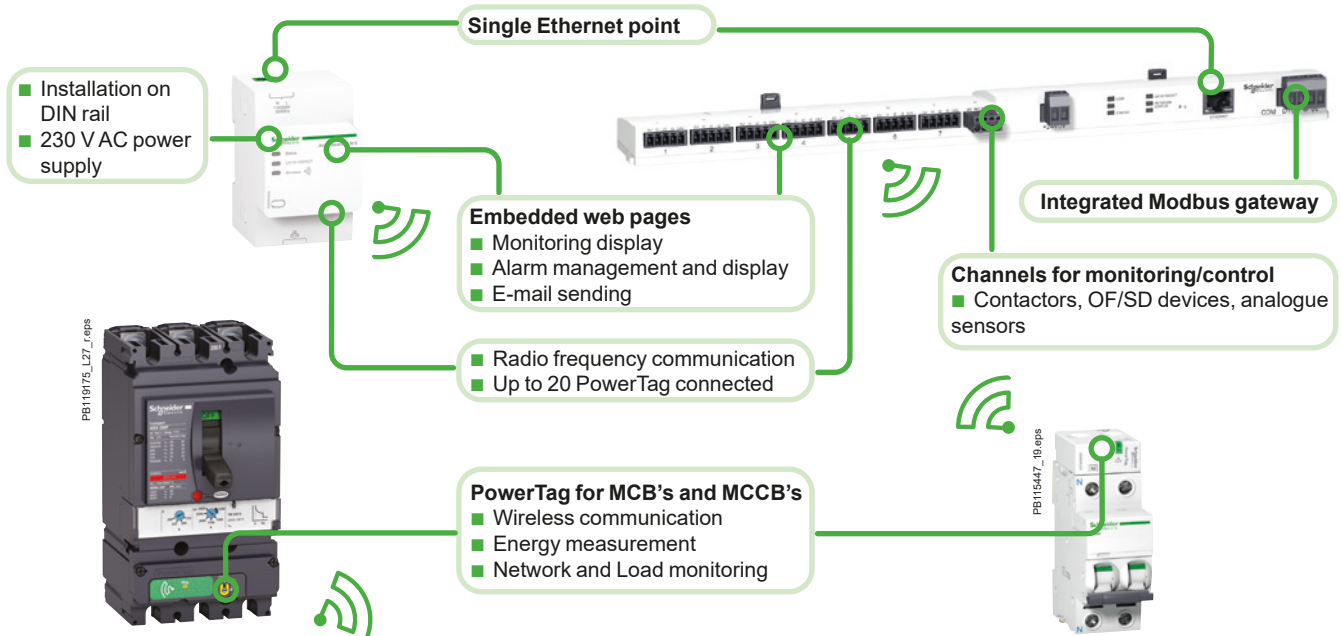

### Technical characteristics

Main characteristics				
Rated voltage	Un	Phase-to-neutral	230 VAC ± 20 %	
		Phase-to-phase	400 VAC ± 20 %	
Frequency			50/60 Hz	
Operating current	In		250 A / 630 A	
Maximum operating current			1.2 x In	
Saturation current			2 x In	
Maximum consumption			3.7 VA	
Starting current	Ist		160 mA / 400 mA	
Base current	Ib		40 A / 100 A	
Additional characteristics				
Operating temperature			-25 °C to +70 °C	
Storage temperature			-50 °C to +85 °C	
Overtoltage category		As per IEC 61010-1	Cat. IV	
Measuring category		As per IEC 61010-2-30	Cat. III	
Pollution degree			3	
Altitude			Up to 2000 m without derating <sup>[1]</sup>	
Degree of protection device			IP20 IK07	
Radio-frequency communication				
ISM band 2.4 GHz			2.4 GHz to 2.4835 GHz	
Channels		As per IEEE 802.15.4	11 to 26	
Isotropic Radiated Power		Equivalent (EIRP)	0 dBm	
Maximum transmission time			< 5 ms	
Channel occupancy		For 1 device	messages sent every 5 seconds	
Characteristics of measuring functions				
Function	Symbol	Performance as per IEC 61557-12		Measuring range (250 A / 630 A)
		Class	Measuring range (250 A / 630 A)	
Active power (per phase, total)	P	1	4 to 250 A / 10 to 630 A	88 W to 416 kW / 221 W to 1048 kW
Total reactive power	Q <sub>A</sub>	2		
Total apparent power	S <sub>A</sub>	2		88 VAR to 416 kVAR / 221 VAR to 1048 kVAR
Active Energy (per phase, total, partial)	E <sub>a</sub>	1		88 VA to 416 kVA / 221 VA to 1048 kVA
Total reactive Energy	E <sub>rA</sub>	2		0 to 281.10 <sup>9</sup> kWh
Frequency	f	1	45 to 55 Hz	45 to 65 Hz
Phase current	I	1	8 to 250 A / 20 to 630 A	160 mA to 500 A / 400 mA to 1260 A
Voltages (Line to Line)	U	0.5	Un ± 20 %	320 to 480 VAC
Power factor (arithmetic)	PF <sub>A</sub>	1	From 0.5 inductive to 0.8 capacitive	-1 to 1

[1] Above 2000 m, please consult us.



# ComPact NSX accessories and auxiliaries

## Additional measurement module: PowerLogic PowerTag NSX

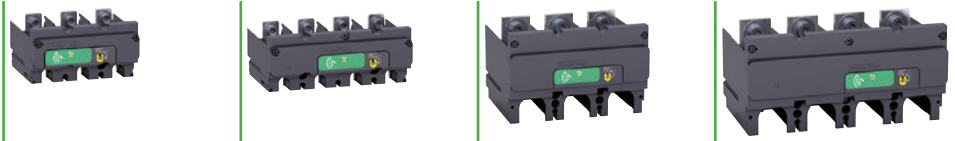

Products (AC network)	Mounting position	250 3P	250 3P+N	630 3P	630 3P+N
<b>ComPact</b>					
<b>Circuit breakers</b>					
<b>NSX100/160/250 B/F/N/H/S/L/R Fixed</b>	3P Bottom	✓	-	-	-
	4P Bottom	-	✓	-	-
<b>NSX400/630 F/N/H/S/L/R Fixed</b>	3P Bottom	-	-	✓	-
	4P Bottom	-	-	-	✓
<b>NSX100/160/250 B/F/N/H/S/L/R Plug-In (mounted on the base)</b>	3P Top / Bottom	✓	-	-	-
	4P Top / Bottom	-	✓ [1]	-	-
<b>NSX400/630 F/N/H/S/L/R Plug-In (mounted on the base)</b>	3P Top / Bottom	-	-	✓ [2]	-
	4P Top / Bottom	-	-	-	✓ [1] [2]
<b>NS100/160/250 N/SX/H/L Fixed</b>	3P Bottom	✓	-	-	-
	4P Bottom	-	✓	-	-
<b>NS400/630 N/H/L Fixed</b>	3P Bottom	-	-	✓	-
	4P Bottom	-	-	-	✓
<b>NS100/160/250 N/SX/H/L Plug-in (mounted on the base)</b>	3P Top / Bottom	✓	-	-	-
	4P Top / Bottom	-	✓ [1]	-	-
<b>NS400/630 N/H/L Plug-in (mounted on the base)</b>	3P Top / Bottom	-	-	✓ [2]	-
	4P Top / Bottom	-	-	-	✓ [1] [2]
<b>Circuit breakers equipped with Vigi block</b>					
<b>NSX100/160/250 B/F/N/H/S/L/R Fixed</b>	3P Bottom	✓	-	-	-
	4P Bottom	-	✓	-	-
<b>NSX400/630 F/N/H/S/L/R Fixed</b>	3P Bottom	-	-	✓	-
	4P Bottom	-	-	-	✓
<b>NSX100/160/250 B/F/N/H/S/L/R Plug-In (mounted on the base)</b>	3P Top	✓	-	-	-
<b>NSX400/630 F/N/H/S/L/R Plug-In (mounted on the base)</b>	3P Top	-	-	✓ [2]	-
<b>Switches</b>					
<b>INS250/INV - 100/160/200/250</b>	3P Bottom	-	✓	-	-
	4P Top / Bottom	-	✓ [1]	-	-
<b>INS/INV - 320/400/500/630</b>	3P Bottom	-	-	-	✓
	4P Top / Bottom	-	-	-	✓ [1]

[1] neutral on the right when mounted on top side

[2] when plate mounted, need to add an intercalary wedging plate under the PowerTag module with following dimensions:

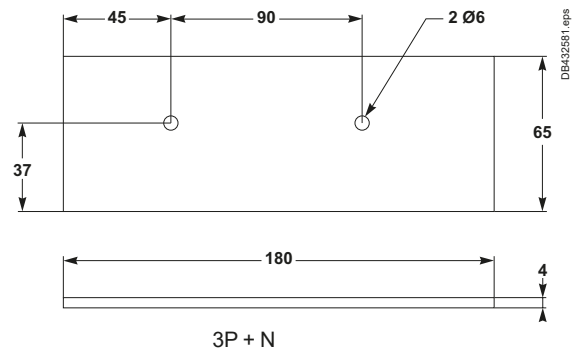
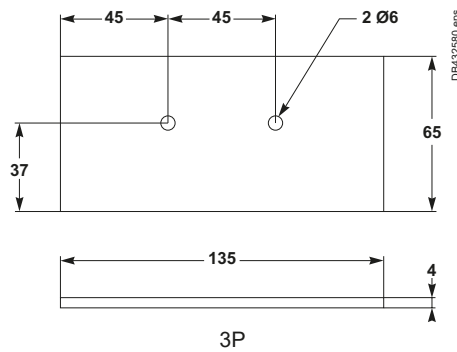

# ComPact NSX accessories and auxiliaries

## Additional measurement and indication modules

PE102795-32.eps



Voltage-presence indicator.

### Voltage-presence indicator

The indicator detects and indicates that circuit breaker terminals are supplied with power.

#### Installation

- Mounted in the long or short terminal shields, via the knockouts.
- May be positioned upstream or downstream of the circuit breaker.
- Degree of protection IP40, IK04.
- Not compatible with the motor-mechanism module.

#### Electrical characteristics

Operates on all networks with voltages ranging from 220 to 550 V AC.

### Current-transformer module

This module enables direct connection of a measurement device such as an ammeter or a power meter.

#### Installation

- The module is installed directly on the downstream circuit-breaker terminals.
- Degree of protection IP40, IK04.
- Class II insulation between front and the power circuits.
- Connection to 6 integrated connectors for cables up to 2.5 mm<sup>2</sup>.

#### Electrical characteristics

- Current transformer with 5 A secondary winding.
- Class 3 for the following output-power consumptions:

Accuracy:

- 100 A rating: 1.6 VA
- 150 A rating: 3 VA
- 250 A rating: 5 VA
- 400/600 A rating: 8 VA.

### Current-transformer module with voltage measurement outputs

This module enables direct connection of a digital measurement device such as a Power Meter PM700, PM800, etc. (not supplied).

#### Installation

- The module is installed directly on the downstream circuit-breaker terminals.
- Degree of protection IP40, IK04.
- Class II insulation between front and the power circuits.
- Built-in connectors for cables from 1.5 to 2.5 mm<sup>2</sup>.

#### Electrical characteristics

- Rated operational voltage U<sub>e</sub>: 530 V
- Frequencies of measured values: 50...60 Hz
- Three CTs with 5 A secondary windings for the rated primary current I<sub>n</sub>:
  - class 0.5 to 1 for rated power consumption values at the output:
    - 125 A, 150 A and 250 A ratings: class 1 for 1.1 VA
    - 400/600 A rating: class 0.5 for 2 VA
  - Connection using a 2.5 mm<sup>2</sup> cable up to 2.5 m long.
  - Four voltage measurement outputs including protection with automatic reset.
  - voltage measurement output resistance 3500 Ω ±25 %, maximum current 1 mA
  - The voltage measurement outputs are intended only for measurements (1 mA max.) and may not be used to supply the display.

### Ammeter and I<sub>max</sub> ammeter modules

#### Ammeter module

Measures and displays (dial-type ammeter) the current of each phase (selection of phases by 3-position switch in front).

#### I<sub>max</sub> ammeter module

Measures and displays (dial-type ammeter) the maximum current flowing in the middle phase. The I<sub>max</sub> value can be reset on the front.

#### Installation

- Identical for both types of ammeter module.
- The module is installed directly on the downstream circuit-breaker terminals.
- The ammeter clips into the module in any of four 90° positions, i.e. it can be installed of devices mounted both vertically and horizontally.
- Degree of protection IP40, IK04.
- Class II insulation between front and the power circuits.

#### Electrical characteristics

- Ammeter module: accuracy class 4.5.
- I<sub>max</sub> ammeter module: accuracy ±6 %.
- Maximum currents are displayed only if they last ≥ 15 minutes.

PE105123.eps



ComPact NSX with current-transformer module.

PE105124.eps



ComPact NSX with ammeter module.

# Customize your circuit breaker with accessories

## ComPact NSX accessories and auxiliaries

### Additional measurement and indication modules

#### Vigi add-on Alarm

This module detects and indicates an insulation drop on a load circuit (TN-S or TT systems).

Operation is identical to that of a Vigi add-on, but without circuit-breaker tripping.

Indication by a red LED in front.

An auxiliary contact may be installed for remote insulation-drop indications.

When insulation drops below a minimum, user-set threshold, the LED goes on and the auxiliary contact switches. The fault indication cannot be cancelled except by pressing the manual reset button.

#### Installation

- The module is installed directly on the downstream circuit-breaker terminals.
- Degree of protection IP40, IK04.
- Double insulation of the front face.

#### Electrical characteristics

- Settings: 100 - 200 - 500 - 1000 mA.
- Accuracy: -50 +0 %.
- Time delay following insulation drop: 5 to 10 seconds.
- AC-system voltage: 200 to 440 V AC.



Vigi add-on Alarm.

# ComPact NSX accessories and auxiliaries

## Locks

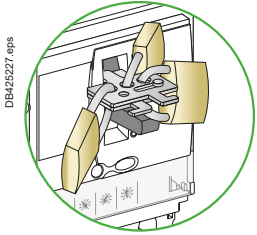

Toggle locking using padlocks and an accessory:  
Removable device

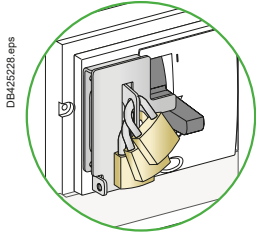

Fixed device attached to the case <sup>[3]</sup>.

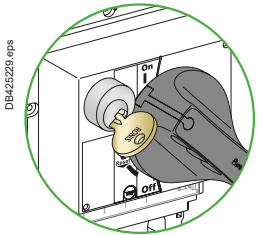

Rotary-handle locking using a keylock.

Locking in the OFF position guarantees isolation as per IEC 60947-2. Padlocking systems can receive up to three padlocks with shackle diameters ranging from 5 to 8 mm (padlocks not supplied). Certain locking systems require an additional accessory.

Control device	Function	Means	Required accessories
Toggle	Lock in OFF position	Padlock	Removable device
	Lock in OFF or ON position	Padlock	Fixed device
Direct rotary handle	Lock in	Padlock	-
	■ OFF position	Keylock	Locking device + keylock
	■ OFF or ON position <sup>[1]</sup>		
MCC	Lock in	Padlock	-
	■ OFF position		
	■ OFF or ON position <sup>[1]</sup>		
CNOMO	Lock in	Padlock	-
	■ OFF position		
	■ OFF or ON position <sup>[1]</sup>		
Extended rotary handle	Lock in	Padlock	-
	■ OFF position		
	■ OFF or ON position <sup>[1]</sup> with door opening prevented <sup>[2]</sup>		
	Lock in OFF position	Padlock	UL508 control accessory
	■ OFF or ON position <sup>[1]</sup> inside the switchboard	Keylock	Locking device + keylock
Motor mechanism	Lock in OFF position	Padlock	-
	remote operation disabled	Keylock	Locking device + keylock
Withdrawable circuit breaker	Lock in	Padlock	-
	■ disconnected position	Keylock	Locking device + keylock
	■ connected position	Keylock	Locking device + keylock

[1] Following a simple modification of the mechanism.

[2] Unless door locking has been voluntarily disabled.

[3] Only for 3P-4P.

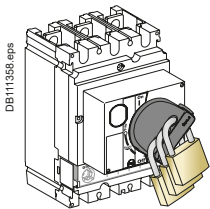

Rotary-handle locking using a padlock or a keylock.

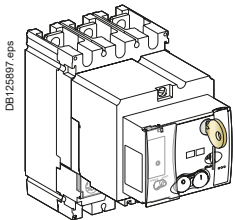
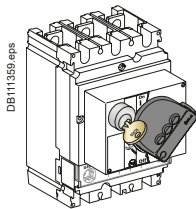

Motor-mechanism locking using a padlock or a keylock.

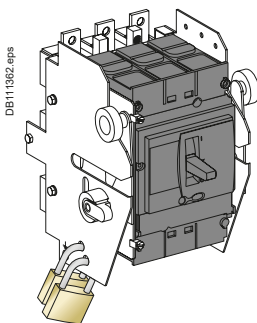
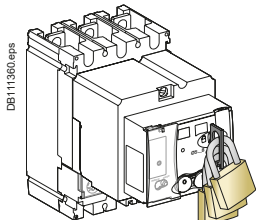

Chassis locking in the connected position.

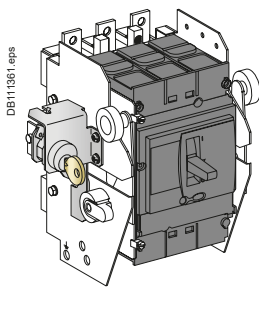

# Customize your circuit breaker with accessories

## ComPact NSX accessories and auxiliaries

### Sealing accessories

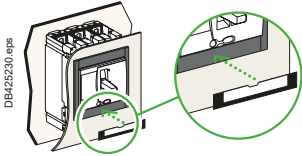

Identification accessories.

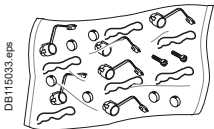

Sealing accessories.

### Outgoing-circuit identification

ComPact NSX100 to 630 can be equipped with label holders supplied in sets of ten (cat. no. LV429226). They are compatible with escutcheons.

### Sealing accessories

Sealing accessories are available. Each bag of accessories contains all the parts required for the types of sealing indicated below.

- A bag contains:
- 6 sealing accessories
  - 6 lead seals
  - 0.5 m of wire
  - 2 screws.

### Types of seals and corresponding functions

<b>Toggle control</b>				
<b>Rotary handle</b>				
<b>Motor mechanism</b>				
<b>Types of seals</b>	<b>Front-cover fixing screw</b>	<b>Trip-unit transparent cover</b>	<b>Motor-mechanism transparent cover</b>	<b>Terminal-shield fixing screw</b>
<b>Protected operations</b>	<ul style="list-style-type: none"> <li>■ front removal</li> <li>■ access to auxiliaries</li> <li>■ trip-unit removal.</li> </ul>	<ul style="list-style-type: none"> <li>■ modification of settings</li> <li>■ access to test connector.</li> </ul>	<ul style="list-style-type: none"> <li>■ access to manual/auto mode selection switch: depending on its position, manual <sup>[1]</sup> or automatic operation is not possible. <b>[1]</b> In this case, local operation is not possible.</li> </ul>	<ul style="list-style-type: none"> <li>■ access to power connections (protection against direct contact).</li> </ul>
<b>Access to Vigi add-on settings</b>				
<b>Types of seals</b>	<b>Vigi add-on fixing device</b>	<b>Protection cover for settings</b>		
<b>Protected operations</b>	<ul style="list-style-type: none"> <li>■ removal of the Vigi add-on.</li> </ul>	<ul style="list-style-type: none"> <li>■ modification of settings.</li> </ul>		



# ComPact NSX accessories and auxiliaries

## Individual enclosures

PB103589-40.epa



IP55 metal enclosure.

PB105120.epa



IP55 insulating enclosure.

Individual enclosures are available for ComPact NSX/ComPact NSX Vigi add-on devices with two, three or four poles.

All fixed, front connections are possible, except right-angle, 45°, double-L and edgewise terminal extensions.

All spreaders may be installed in the enclosures intended for ComPact NSX/ComPact NSX Vigi add-on 250 to 630 devices, except the 70 mm spreaders for NSX400/630.

### Two models of enclosures

■ IP55 metal individual enclosure, with:

- metal enclosure
- door with keylock and cut-out for rotary handle
- extended rotary handle, IP55, IK08, black or red/yellow
- device mounting plate
- removable plate (without holes) for cable entry through bottom.

■ IP55 insulating individual enclosure, with:

- polyester insulating enclosure
- transparent cover, screwed, neoprene gasket, with cut-out for extended rotary handle
- extended rotary handle, IP55, IK08, black or red/yellow
- device mounting plate
- 2 removable plates (without holes) for cable entry through bottom and/or top.

### Dimensions (H x W x D in mm)

■ Metal enclosures:

□ ComPact NSX100/160	450 x 350 x 250
□ ComPact NSX250 and ComPact NSX100 to 250 Vigi add-on	650 x 350 x 250
□ ComPact NSX400	650 x 350 x 250
□ ComPact NSX630 and ComPact NSX400/630 Vigi add-on	850 x 600 x 250

■ Insulating enclosures:

□ ComPact NSX100/160	360 x 270 x 235
□ ComPact NSX250 and ComPact NSX100/160 Vigi add-on	540 x 270 x 235
□ ComPact NSX400/630	720 x 360 x 235
□ ComPact NSX250/630 Vigi add-on	720 x 360 x 235

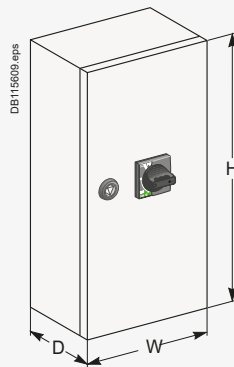

DB115609.epa

# Customize your circuit breaker with accessories

## ComPact NSX accessories and auxiliaries

### Escutcheons and protection collars

#### IP30 or IP40 escutcheons for fixed devices

##### IP30

- The three types are glued to the cut-out in the front door of the switchboard:
- escutcheon for all control types (toggle, rotary handle or motor mechanism)
  - without access to the trip unit
  - with access to the trip unit
  - for Vigi add-on, can be combined with the above.

##### IP40

- The four types, with a gasket, are screwed to the door cut-out:
- three escutcheons identical to the previous, but IP40
  - a wide model for Vigi and ammeter modules that can be combined with the above.

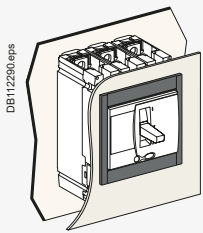

DB112290.eps

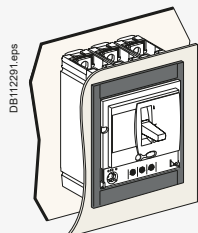

DB112291.eps

Escutcheon for toggle without and with access to the trip unit.

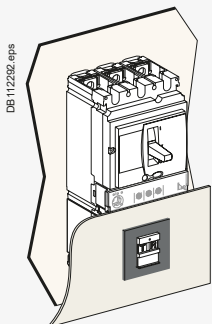

DB 112292.eps

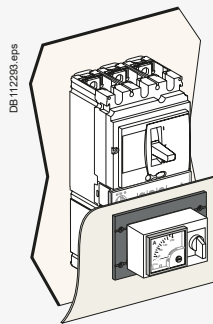

DB 112293.eps

Escutcheon for Vigi add-on.

Wide escutcheon for ammeter.

Escutcheons are an optional feature mounted on the switchboard door. They increase the degree of protection to IP40, IK07. Protection collars maintain the degree of protection, whatever the position of the device (connected, disconnected).



IP30 escutcheon.



IP30 escutcheon with access to the trip unit.

PB105119.eps

PB105126.eps



# ComPact NSX accessories and auxiliaries

## Escutcheons and protection collars

PB103777\_36.eps



Escutcheon with collar for toggle.

PB103790\_36.eps



Escutcheon for Vigi add-on.

PB103775\_40.eps



Toggle cover.

PB103820\_35.eps



NS retrofit front cover.

### IP40 escutcheons for withdrawable devices

#### IP40 for withdrawable devices

The two types, with a gasket, are screwed to the door cut-out:

- for rotary handle or motor mechanism: standard IP40 escutcheon
- for toggle with extension: standard escutcheon + collar for withdrawal.

DB112284.eps

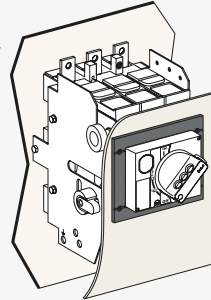

Standard escutcheon with rotary handle.

DB112285.eps

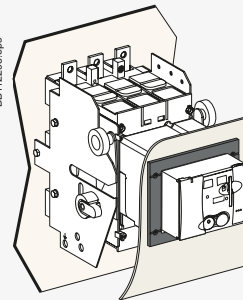

Standard escutcheon for motor mechanism.

DB112286.eps

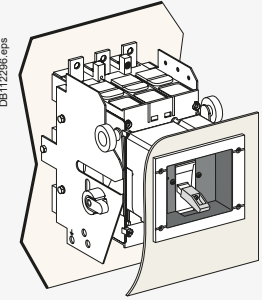

Standard escutcheon with collar for withdrawal, for toggle.

#### IP40 for Vigi add-on on withdrawable devices

The two types, with a gasket, are screwed to the door cut-out:

- for rotary handle or motor mechanism: standard IP40 escutcheon
- for toggle: standard escutcheon + collar for withdrawal.

DB112287.eps

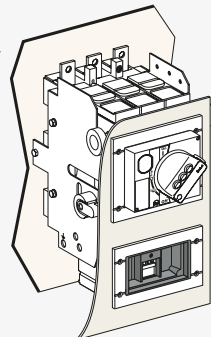

DB112288.eps

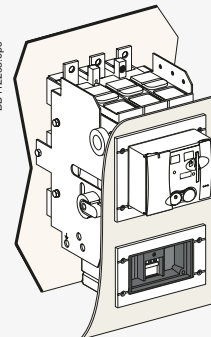

DB112289.eps

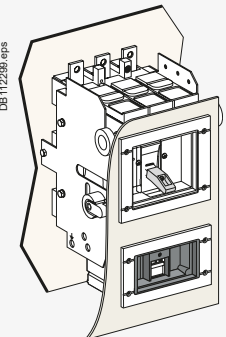

Escutcheon for Vigi add-on, with escutcheons for the three types of control.

### IP43 toggle cover

Available only for devices with toggles. Fits over toggle and front cover of the device.

- Mounted on the front of the circuit breaker.
- Degree of protection IP43, IK07.

DB112218.eps

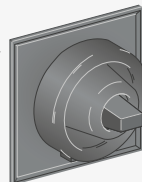

Toggle cover.

### Retrofit front covers

These replacement front covers make it possible to install NSX devices in existing switchboards containing NS devices by installing the NS-type retrofit covers on the NSX devices.

- NS100 to 250 cover.
- NS400/630 cover.



# Smart Panel integration

- Enerlin'x functions**
  - Communication wiring system..... D-2
  - Overview of functions..... D-3
- Enerlin'X digital system**
  - Overview ..... D-4
- Com'X 510**
  - Energy server..... D-6
- FDM128 Ethernet switchboard display .....D-8**
- FDM121 switchboard display ..... D-10**
- IFE interface**
  - IFE switchboard server ..... D-12
  - IFM Modbus interface..... D-14
- Components**
  - I/O Application module..... D-16
- Customer engineering tool: EcoStruxure Power**
  - Commission software..... D-18



<b>Other chapters</b>	
Select your circuit breakers and switch-disconnectors .....	A-1
Select your protection .....	B-1
Customize your circuit breaker with accessories.....	C-1
Switchboard integration .....	E-1
Catalog numbers .....	F-1
Glossary .....	G-1
Additional characteristics .....	H-1

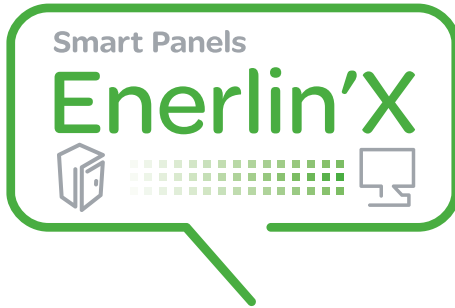

Get circuit breaker status and electrical values  
**Available information and functions**

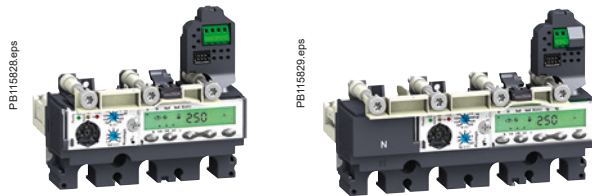

MicroLogic trip units for 3 poles, 4 poles ComPact circuit breakers

Available functions	MicroLogic type	
<b>Status indications</b>		
ON/OFF (O/F)	A	E
Fault-trip SDE	A	E
Connected / disconnected / test position CE/CD/CT (I/O module only)	A	E
<b>Controls</b>		
Open	A	E
Close	A	E
<b>Measurements</b>		
Instantaneous measurement information	A	E
Averaged measurement information		E
Maximeter / minimeter	A	E
Energy metering		E
Demand for current and power		E
Power quality		E
<b>Operating assistance</b>		
Protection and alarm settings	A	E
Histories	A	E
Time stamped event tables	A	E
Maintenance indicators	A	E

All ComPact circuit breakers are equipped with a MicroLogic trip unit. This adjustable unit is mainly designed for tripping the circuit breaker in case of necessity and monitoring the downstream circuit. Alarms may be programmed for remote indications. Electrical measurements, operation data for predictive maintenance, are provided for local display or distant monitoring.

# Smart Panel integration

## Enerlin'x functions

### Overview of functions

Fixed ComPact NSX circuit breaker

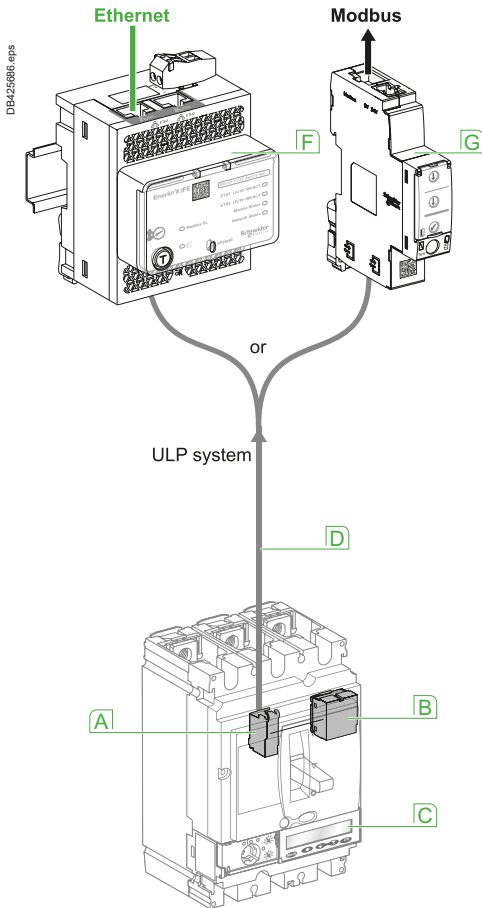

Drawout ComPact NSX circuit breaker

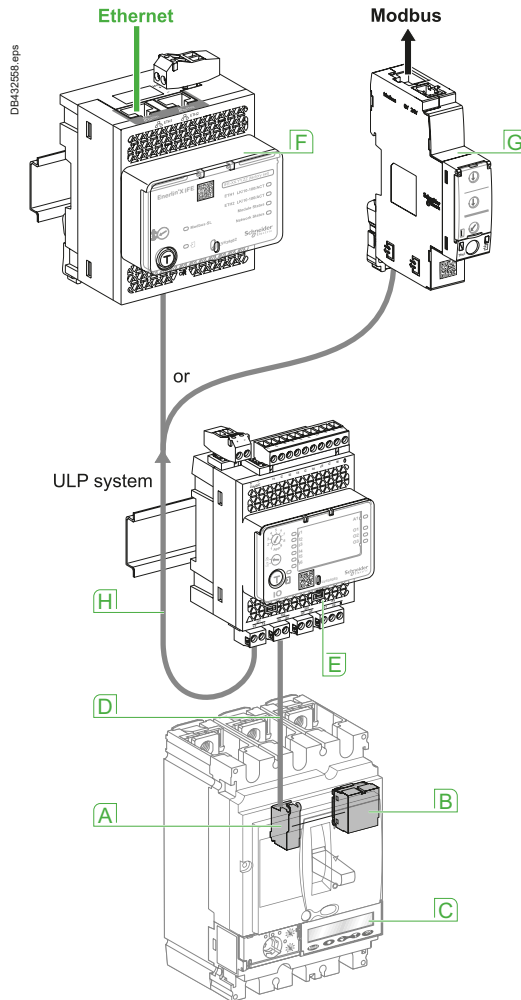

- A** Internal terminal block for communication via NSX cord
- B** BSCM module
- C** MicroLogic trip unit
- D** NSX cord
- E** I/O module
- F** IFE interface module
- G** IFM module
- H** ULP cable



#### ULP system

is a fast communication link dedicated to circuit breaker monitoring and control. Based on a RS485 physical liaison with cable segments up to 5 meters, it is well adapted to severe environment. A choice of 6 pre-connectorized cables with different length is provided.

#### IFE interface ULP to Ethernet interface module

Provides and IP address to any circuit breaker fitted with an ULP port. The IFE interface makes all available data from the circuit breaker accessible from an Ethernet compatible display (FDM128), a PC with common browser, or IFE switchboard server which generates its own web pages.

#### IFM ULP to Modbus Interface module

Makes all available data of a circuit breaker fitted with an ULP port accessible via a Modbus network. IFM acts as a Modbus slave, accessible from a Modbus master (IFE switchboard server, Acti 9 Smartlink Ethernet or Com'X).

#### I/O I/O application module

I/O is dedicated to circuit breaker with ULP liaison. It provides the monitoring and control of any application around the circuit breaker (lighting or load control, cooling system, pulse metering acquisition...).

# Enerlin'X digital system Overview

Enerlin'X communication system provides access to status, electrical values and devices control using Ethernet and Modbus SL communication protocols.

**Ethernet** has become the universal link between switchboards, computers and communication devices inside the building. The large amount of information which can be transferred makes the connection of Enerlin'X digital system to hosted web services of Schneider Electric a reality. More advantages are offered to integrators thanks to configuration web pages available remotely or on the local Ethernet network.

**Modbus SL** is the most widely used communication protocol in industrial networks. It operates in master-slave mode. The devices (slaves) communicate one after the other with a gateway (master).

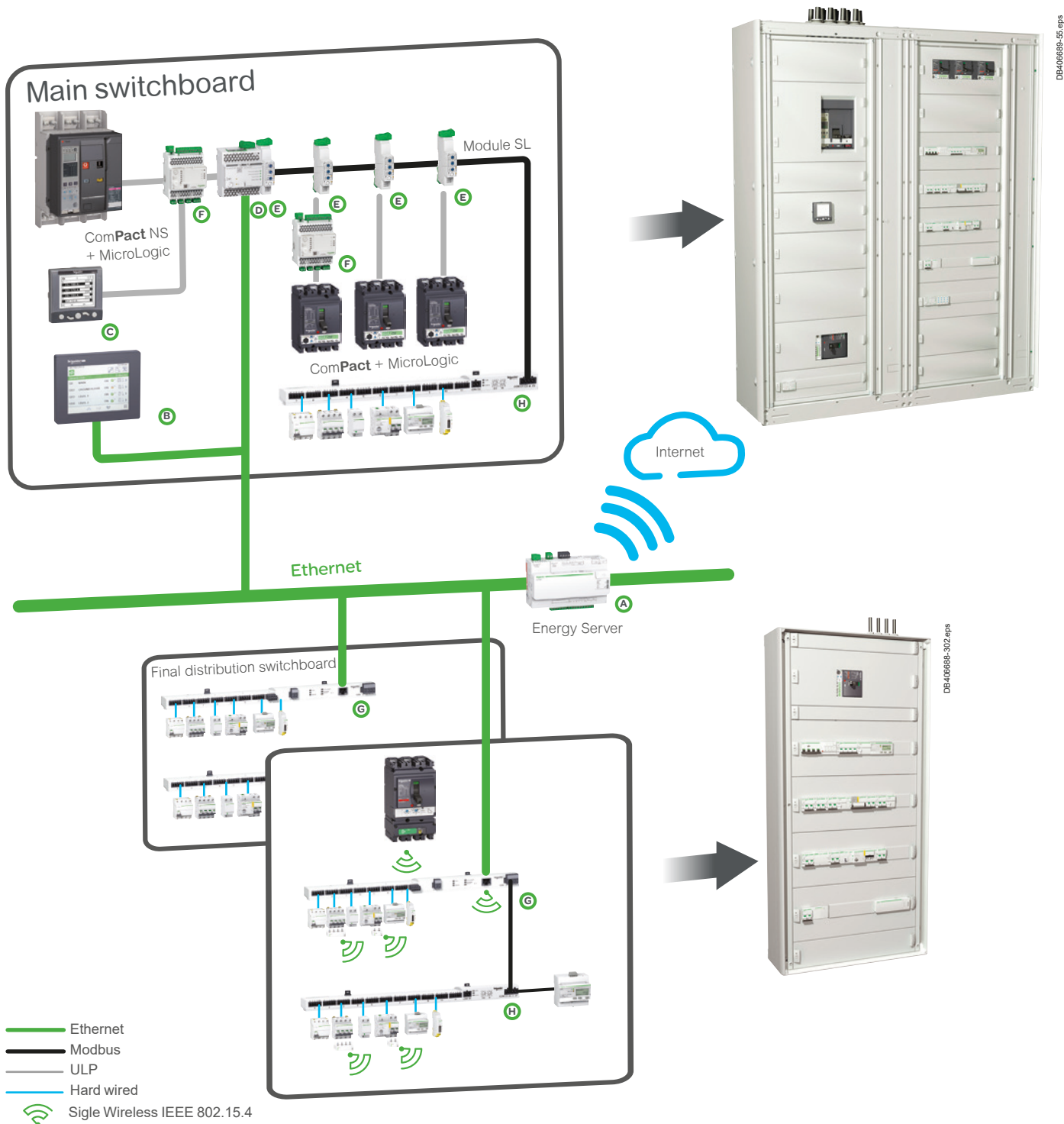

DB40688-35 eps









DB40688-302 eps

D

# Smart Panel integration

## Enerlin'X digital system

### Overview

Enerlin'X digital devices and displays							
	Name	Function	Port (to device)	(to server)	Inputs	Outputs	Cial. Ref.
A	 Com'X 210	Energy data logger + Ethernet Gateway	Ethernet Modbus Master, Zigbee (to wireless meters)	Ethernet cable + WiFi	64 devices: 6 binary 2 analog 32 Modbus devices + other Ethernet devices (Modbus TCP)	-	EBX210
	Com'X 510 24 V DC + PoE	Energy server + Ethernet Gateway				-	EBX510
B	 FDM128	Ethernet LCD colour touch screen	-	Ethernet		-	LV434128
C	 FDM121	LCD display for circuit breaker	ULP	-	1 circuit breaker	-	TRV00121
D	 IFE Switchboard server	Switchboard server	Modbus Master & ULP	Ethernet	20 circuit breakers	-	LV434002
	IFE interface	Ethernet interface for circuit breakers	ULP	Ethernet	1 circuit breaker	-	LV434001
E	 IFM	Modbus interface for circuit breaker	ULP	Modbus Slave	1 circuit breaker	-	LV434000
F	 I/O	Input/Output application module for circuit breaker	ULP	ULP	6 binary 1 analog (PT100 sensor)	3	LV434063
G	 Acti 9 Smartlink SI B Ethernet wireless	Ethernet server for I/O and Modbus slave devices	Modbus Master & Wireless to PowerTag	Ethernet	14 binary 2 analog	7	A9XMZA08
H	 Acti 9 Smartlink Modbus slave	Modbus interface with Input/Output functions	-	Modbus Slave	22 binary	11	A9XMSB11

D

**Ethernet Gateway or Interface:** routes an internal traffic (ULP or other protocole) to the Internet, the outgoing messages are coded with Modbus TCP/IP protocol.

**Server (Switchboard, Energy):** routes the internal traffic to the Internet. Other complementary functions such as data logging and storage. Provides devices status and energy trends on internal web pages...

**Note:** for more information please consult: [Configuration & commissioning guide of connected devices & software - New buildings](#)

# Com'X 510

## Energy server



### Main functions

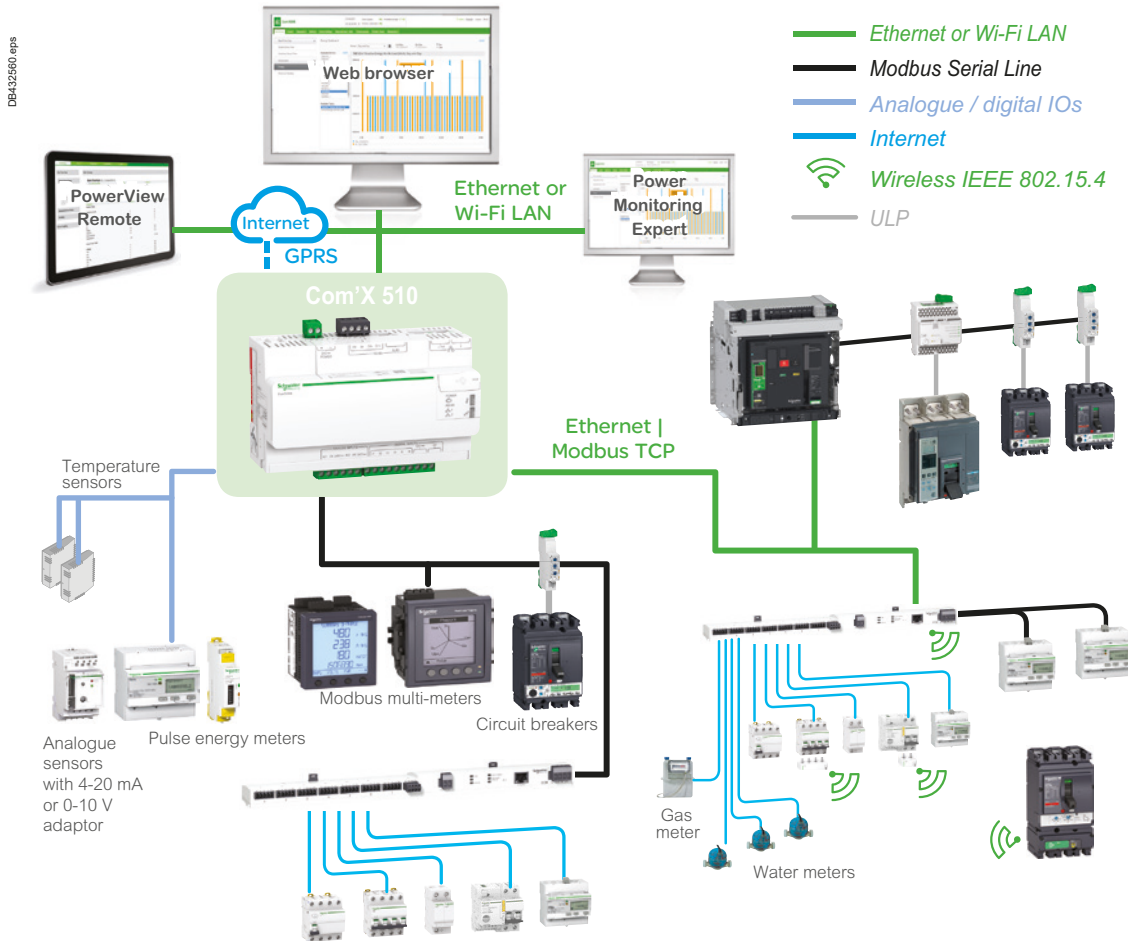

#### Data collector

Collects and stores energy data from up to 64 field devices, connected to either:

- ethernet TCP/IP field network
- modbus Serial line network (up to 32 devices)
- embedded digital and analogue inputs.

"Field devices" consist of:

- PowerLogic meters for power and energy monitoring
- MasterPact, PowerPact, or ComPact circuit-breakers for protection and monitoring
- Acti 9 protection devices, meters, remote controlled switches, etc
- water, Air, Gas, Electricity, and Steam consumption meters, from specialized manufacturers, delivering pulses as per standard (see table at end of this document)
- environmental sensors such as temperatures, humidity, and CO2 levels in a building, providing analogue information.

Data logging and storage capabilities include:

- data logging period: configurable from every minute to once a week
- data storage duration: up to 2 years, depending on quantity of collected data
- able to set time and send reset instructions to field devices.

#### Embedded energy management software

The Com'X provides the end-user with immediate visibility into energy consumption throughout the site. As soon as the Com'X is connected to the Local Area Network (LAN), several web pages are accessible via any standard web browser, (without plug-in or additional components).

These web pages display real-time data as it is collected, in easy to understand tabular and summary formats. In addition, users can get simple analysis of historical data in bar graph or trending formats.

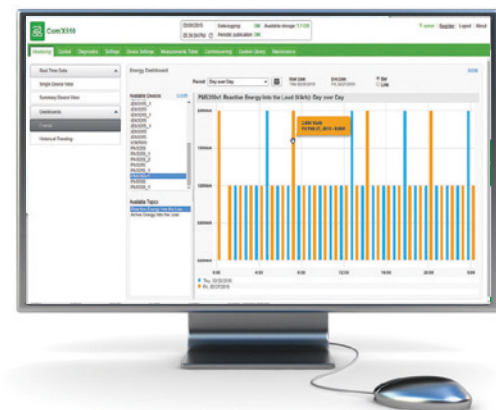

Energy dashboard comparing accumulated over time energy values (partial screen)

# Smart Panel integration

## Com'X 510

### Energy server



Energy Server Com'X 510 data logger



Raw data and measurements from one field device (partial screen)

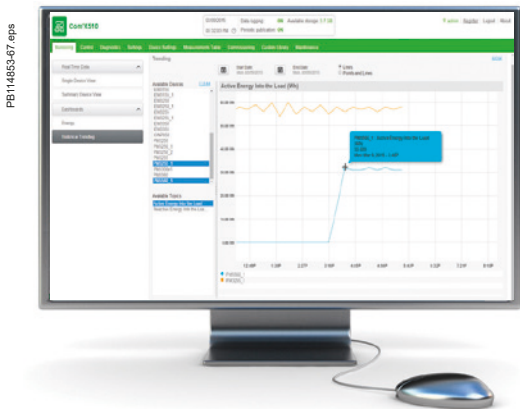

Historical trending comparing multiple devices or multiple topics (partial screen)

### Additional functions

#### Data publisher

Batches of collected data can also be periodically transmitted to an Internet server, as:

- XML files, for processing by StruXureware™ web services, such as EcoStruxure™ Facility Advisor
- CSV files for viewing in Excel or transformed or uploading to programs such as StruXureware™ EcoStruxure™ Power Monitoring Expert or any compatible software.

Data publishing function supports 4 transfer protocols over Ethernet or Wi-Fi:

- HTTP
- HTTPS
- FTP
- SMTP.

#### Gateway

If selected by the user, the Com'X510 can make data from connected devices available in real time:

- in Modbus TCP/IP format over Ethernet or Wi-Fi
- for requests by energy management software
- gateway to Zigbee device data by external Modbus TCP/IP clients.

Modbus packets can be sent from managing software to field devices through Modbus serial line or Modbus TCP/IP over Ethernet.



### Com'X 510 Commercial reference numbers

Com'X 510 energy server 24 V DC power supplied UL rated	<b>EBX510</b>
Com'X Wi-Fi USB interface	<b>EBXA-USB-WIFI</b>
Com'X GPRS interface SIM card	<b>EBXA-GPRS-SIM</b>
Com'X GPRS interface	<b>EBXA-GPRS</b>
Com'X External GPRS antenna	<b>EBXA-ANT-5M</b>
Com'X Zigbee USB interface	<b>EBXA-USB-Zigbee</b>

Please see your Schneider Electric representative for complete ordering information.

# FDM128 Ethernet switchboard display

MicroLogic measurement capabilities come into full play with the FDM128 switchboard display. It connects to Ethernet communication via RJ45 port and displays MicroLogic information. The result is a true integrated unit combining a circuit breaker and a Power Meter. Additional operating assistance functions can also be displayed.

## FDM128

The FDM128 is an intelligent Ethernet display. It collects the data from up to 8 devices via Ethernet network.

The FDM128 switchboard display unit can be connected to a MicroLogic COM option (BCM ULP via IFE). It uses the sensors and processing capacity of the MicroLogic control unit. It is easy to use and requires no special software or settings. The FDM128 is a large display, but requires very little depth. The anti-glare graphic screen is backlit for very easy reading even under poor ambient lighting and at sharp angles.

### Display of MicroLogic measurements and trips

The FDM128 is intended to display MicroLogic A/E measurements, trips and operating information. It cannot be used to modify the protection settings.

Measurements may be easily accessed via a menu.

Trips are automatically displayed.

A pop-up window displays the time-stamped description of the trip.

### Status indications

When the circuit breaker is equipped with the Breaker Status Command Module (BSCM) and NSX cord, the FDM128 display can also be used to view circuit breaker status conditions:

- O/F: ON/OFF
- SDE: Fault-trip indication (overload, short-circuit, ground fault)
- CE, CD cradle management with I/O application module.

### Remote control

When the circuit breaker is equipped with the BSCM, NSX cord and Communicating Motor Mechanism (MTc), the FDM128 display can also be used to control (open/close) the circuit breaker.

### Main characteristics

- 115.2 x 86.4 mm with 5.7" QVGA display 320 x 240 pixels.
- Color TFT LCD, LED backlight.
- Wide viewing angle: vertical  $\pm 80^\circ$ , horizontal  $\pm 70^\circ$ .
- High resolution: excellent reading of graphic symbols.
- Operating temperature range  $-10^\circ\text{C}$  to  $+55^\circ\text{C}$ .
- CE / UL / CSA marking (pending).
- 24 V DC power supply, with tolerances 24 V (limit 20.4 - 28.8 V DC).
- Consumption  $\leq 6.8$  W.

### Mounting

The FDM128 is easily installed in a switchboard.

- Standard door hole  $\varnothing 22$  mm.

The FDM128 degree of protection is IP65 in front and IP54.

### Connection

The FDM128 is equipped with:

- a 24 V DC terminal block:
- power supply range of 24 V DC (limit 20.4 - 28.8 V DC). The FDM128 display unit has a 2-point screw connector on the rear panel of the module for this purpose.
- One RJ45 Ethernet jacks.

The MicroLogic connects to the internal communication terminal block on the MasterPact via the breaker ULP cord and Ethernet connection through IFE.



FDM128 display.

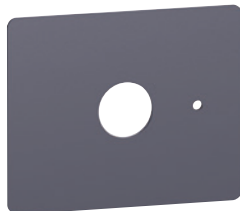

Surface mount accessory.









# FDM128 Ethernet switchboard display

## Navigation

Touch screen is used for intuitive and fast navigation. The user can select the display language (Chinese, English, French, German, Italian, Portuguese, Spanish, etc.).

## Screens

### Main menu

-  Quick view
-  Alarms
-  Metering
-  Maintenance
-  Control

When not in use, the screen is automatically shifted to low back-lighting.

### Fast access to essential information

■ "Quick view" provides access to five screens that display a summary of essential operating information (I, U, f, P, E, THD, circuit breaker On / Off).

### Access to detailed information

- "Metering" can be used to display the measurement data (I, U-V, f, P, Q, S, E, THD, PF) with the corresponding min/max values.
- Alarms displays the trip history.
- Services provides access to the operation counters, energy and maximeter reset function, maintenance indicators, identification of modules connected to the internal bus and FDM128 internal settings (language, contrast, etc.).



Product identification.

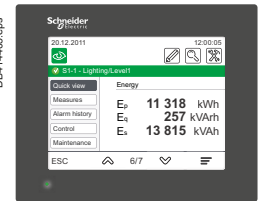

Metering: meter.

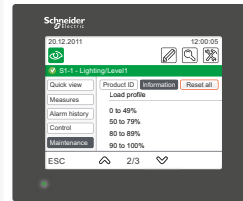

Services.

DB4-14407 eps

DB4-14405 eps

DB4-14408 eps



# FDM121 switchboard display

MicroLogic measurement capabilities come into full play with the FDM121 switchboard display. It connects to COM option (BCM ULP) via a breaker ULP cord and displays MicroLogic information. The result is a true integrated unit combining a circuit breaker and a Power Meter. Additional operating assistance functions can also be displayed.

## FDM121

An FDM121 switchboard display unit can be connected to a ULP IMU using a prefabricated cord to display all measurements, alarms, histories and event tables, maintenance indicators, management of installed devices on a screen. The result is a veritable 96 x 96 mm Power Meter.

The FDM121 display unit requires a 24 V DC power supply.

The FDM121 is a switchboard display unit that can be integrated in the ComPact NSX100 to 630 A, PowerPact H/J/L/P/R, compact NS or MasterPact systems. It uses the sensors and processing capacity of the MicroLogic trip unit. It is easy to use and requires no special software or settings. It is immediately operational when connected to the ComPact NSX by a simple cord.

Also, it provides monitoring and control with the use of the I/O application module, the motor mechanism module, or the Breaker Status module.

The FDM121 is a large display, but requires very little depth. The anti-glare graphic screen is backlit for very easy reading even under poor ambient lighting and at sharp angles.

### Display of MicroLogic measurements and alarms

The FDM121 is intended to display MicroLogic 5 / 6 measurements, alarms and operating information. It cannot be used to modify the protection settings.

Measurements may be easily accessed via a menu. All user-defined alarms are automatically displayed. The display mode depends on the priority level selected during alarm set-up:

- high priority: a pop-up window displays the time-stamped description of the alarm and the orange LED flashes
- medium priority: the orange "Alarm" LED goes steady on
- low priority: no display on the screen.

All faults resulting in a trip automatically produce a high-priority alarm, without any special settings required. In all cases, the alarm history is updated. MicroLogic saves the information in its non-volatile memory in the event of an FDM121 power failure.

### Status indications and remote control

When the circuit breaker is equipped with the Breaker Status Module, the FDM121 display can also be used to view circuit breaker status conditions:

- O/F: ON/OFF
- SD: trip indication
- SDE: Fault-trip indication (overload, short-circuit, ground fault).

When the circuit breaker system is equipped with the I/O Application module, the FDM121 can monitor and control:

- cradle management
- circuit breaker operation
- light and load control
- custom application.

When the circuit breaker system is equipped with the motor mechanism module, the FDM121 offers remote closing and opening control.

### Main characteristics

- 96 x 96 x 30 mm screen requiring 10 mm behind the door (or 20 mm when the 24 V power supply connector is used).
  - White backlighting.
  - Wide viewing angle: vertical  $\pm 60^\circ$ , horizontal  $\pm 30^\circ$ .
  - High resolution: excellent reading of graphic symbols.
  - Alarm LED: flashing orange for alarm pick-up, steady orange after operator reset if alarm condition persists.
  - Operating temperature range  $-10^\circ\text{C}$  to  $+55^\circ\text{C}$ .
  - CE / UL / CSA marking (pending).
  - 24 V DC power supply, with tolerances 24 V  $-20\%$  (19.2 V) to 24 V  $+10\%$  (26.4 V).
- When the FDM121 is connected to the communication network, the 24 V DC can be supplied by the communication system wiring system.
- Consumption 40 mA.

### Mounting

The FDM121 is easily installed in a switchboard.

- Standard door cut-out 92 x 92 mm.
- Attached using clips.

To avoid a cut-out in the door, an accessory is available for surface mounting by drilling only two 22 mm diameter holes.

The FDM121 degree of protection is IP54 in front. IP54 is maintained after switchboard mounting by using the supplied gasket during installation.

### Connection

The FDM121 is equipped with:

- a 24 V DC terminal block:
  - plug-in type with 2 wire inputs per point for easy daisy-chaining
  - power supply range of 24 V DC  $-20\%$  (19.2 V) to 24 V DC  $+10\%$  (26.4 V).

A 24 V DC type auxiliary power supply must be connected to a single point on the ULP system. The FDM121 display unit has a 2-point screw connector on the rear panel of the module for this purpose. The ULP module to which the auxiliary power supply is connected distributes the supply via the ULP cable to all the ULP modules connected to the system and therefore also to MicroLogic.

D

PB119233.eps



FDM121 display.

PB103807-3x2.eps



Surface mount accessory.

PB119235.eps



Connection with FDM121 display unit.

# Smart Panel integration FDM121 switchboard display

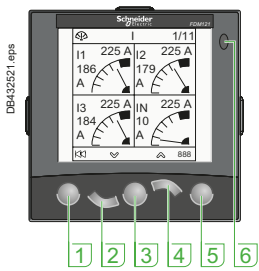

- 1 escape
- 2 down
- 3 ok
- 4 up
- 5 context
- 6 alarm LED

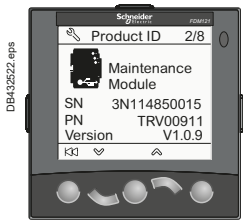

Product identification.

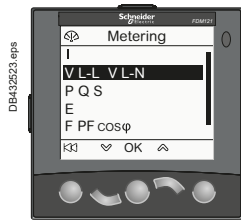

Metering: sub-menu.

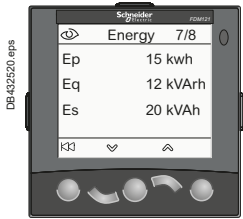

Metering: meter.

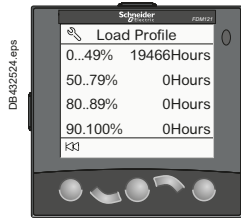

Services.

■ two RJ45 jacks.

The MicroLogic connects to the internal communication terminal block on the ComPact NSX via the NSX cord. Connection to one of the RJ45 connectors on the FDM121 automatically establishes communication between the MicroLogic and the FDM121 and supplies power to the MicroLogic measurement functions. When the second connector is not used, it must be fitted with a line terminator.

### Navigation

Five buttons are used for intuitive and fast navigation. The "Context" button may be used to select the type of display (digital, bargraph, analogue). The user can select the display language (Chinese, English, French, German, Italian, Portuguese, Spanish, etc.).

### Screens

#### Main menu

When powered up, the FDM121 screen automatically displays the ON/OFF status of the device.



When not in use, the screen is not backlit. Backlighting can be activated by pressing one of the buttons. It goes off after 3 minutes.

#### Fast access to essential information

■ "Quick view" provides access to five screens that display a summary of essential operating information (I, U, f, P, E, THD, circuit breaker On / Off).

#### Access to detailed information

- "Metering" can be used to display the measurement data (I, U-V, f, P, Q, S, E, THD, PF) with the corresponding min/max values.
- Alarms displays active alarms and the alarm history.
- Services provides access to the operation counters, energy and maximeter reset function, maintenance indicators, identification of modules connected to the internal bus and FDM121 internal settings (language, contrast, etc.).

### Communication components and FDM121 connections

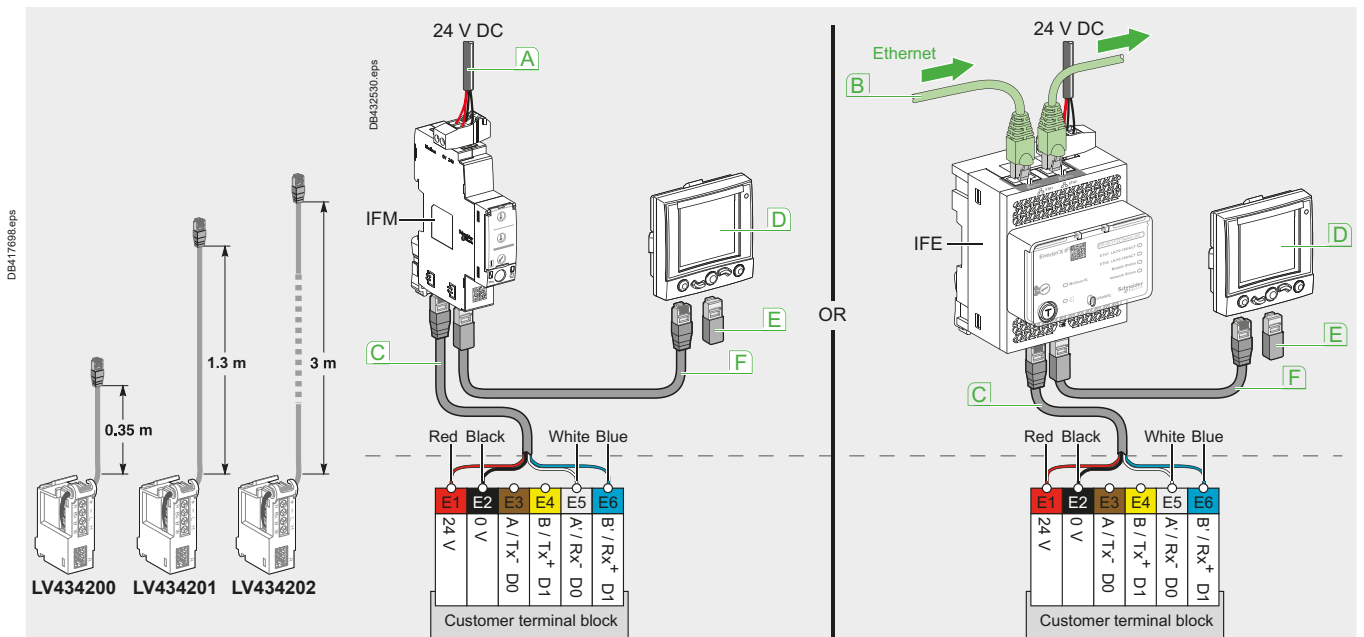

#### Connections

- ComPact NSX is connected to the ULP devices (FDM121 display, IFM, IFE or I/O) unit via the NSX cord.
  - cord available in three lengths: 0.35 m, 1.3 m and 3 m.
  - ULP lengths up to 10 m possible using extensions.

- A Modbus network
- B Ethernet network
- C NSX cord

- D FDM121 display
- E ULP termination
- F ULP cable

## Smart Panel integration

## IFE interface

## IFE switchboard server

PB115852.eps



IFE interface, ref.: LV434001

PB115856.eps



IFE switchboard server, ref.: LV434002

DB408743-57.eps

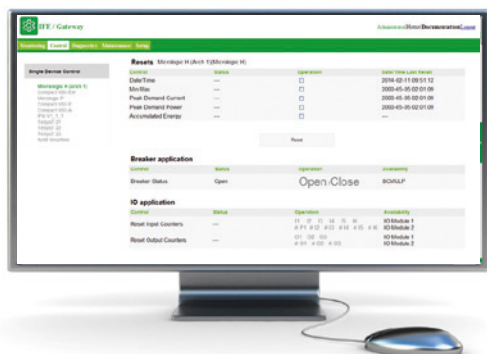

## Description

The IFE interface and IFE switchboard server enable LV circuit breakers as MasterPact NT/NW, MasterPact MTZ, ComPact NSX or PowerPact to be connected to an Ethernet network.

### IFE interface: ref. LV434001

Provides an Ethernet access to a single LV circuit breaker.

### Function

Interface - one circuit breaker is connected to the IFE interface via its ULP port.

### IFE switchboard server: ref. LV434002

Provides an Ethernet access up to 20 LV circuit breakers.

### Functions

- Interface - one circuit breaker is connected to the IFE interface via its ULP port.
- Server: several circuit breakers on a Modbus network are connected via the IFE switchboard server master Modbus port.
- Collects and provides web pages from multiple IP devices (other IFE LV434002, Smartlink Ethernet, PM5000 Ethernet...).

### IFE interface, IFE switchboard server features

- Dual 10/100 Mbps Ethernet port for simple daisy chain connection.
- Device profile web service for discovery of the IFE interface, IFE switchboard server on the LAN.
- ULP compliant for localization of the IFE interface in the switchboard.
- Ethernet interface for ComPact, MasterPact and PowerPact circuit breakers.
- Gateway for Modbus-SL connected devices (IFE switchboard server only).
- Embedded set-up web pages.
- Embedded monitoring web pages.
- Embedded control web pages.
- Built-in e-mail alarm notification.
- Automatic recovering of Smartlink I/O configurations, allowing contextual I/O status display on web pages (IFE switchboard server only).
- Internal real-time clock with battery back-up.
- RBAC (Role Base Access Control) for the embedded control web pages
- RSTP (Rapid Scanning Tree Protocol) is a solution to implement redundant Ethernet networks.

## Mounting

The IFE interface, IFE switchboard server are DIN rail mounting devices.

A stacking accessory enables the user to connect several IFMs (ULP to Modbus interfaces) to an IFE switchboard server without additional wiring.

### 24 V DC power supply

The IFE interface, IFE switchboard server must always be supplied with 24 V DC. The IFMs stacked to an IFE switchboard server are supplied by the IFE switchboard server, thus it is not necessary to supply them separately. It is recommended to use an UL listed and recognized limited voltage/limited current or a class 2 power supply with a 24 V DC, 3 A maximum.

### IFE interface, IFE switchboard server firmware update

The firmware can be updated using:

- FTP
- customer engineering tool
- EcoStruxure Power Commission software.

### Required circuit breaker communication modules

The connection to IFE interface or IFE switchboard server requires a communication module embedded into the circuit breaker:

- ComPact NS, PowerPact P, PowerPact R: BCM ULP communication module
- ComPact NSX: NSX cord and/or BSCM module
- MasterPact NT/NW, MasterPact MTZ or ComPact NS, PowerPact P, PowerPact R (Fixed electrically operated): BCM ULP communication module
- drawout MasterPact NT/NW, MasterPact MTZ or a withdrawable ComPact NS, PowerPact P, PowerPact R: BCM ULP and its respective I/O (Input/Output) application module.

All connection configurations for MasterPact NT/NW, MasterPact MTZ, ComPact NS, PowerPact P, PowerPact R require the breaker ULP cord.

The insulated NSX cord is mandatory for system voltages greater than 480 V AC. When the second ULP RJ45 connector is not used, it must be closed with an ULP terminator (TRV00880).

# Smart Panel integration

## IFE interface

### IFE switchboard server

### General characteristics

Environmental characteristics	
Conforming to standards	UL 508, UL 60950, IEC 60950, 60947-6-2
Certification	cULus, GOST, FCC, CE
Ambient temperature	-20 to +70°C (-4 to +158 °F)
Relative humidity	5–85 %
Level of pollution	Level 3
Flame resistance	ULV0 conforming to IEC/EN 60068-2-30

Mechanical characteristics	
Shock resistance	1000 m/s <sup>2</sup>
Resistance to sinusoidal vibrations	5 Hz < f < 8.4 Hz conforming to IEC/EN 60068-2-6

Electrical characteristics	
Resistance to electromagnetic discharge	Conforming to IEC/EN 61000-4-3
Immunity to radiated fields	10 V/m
Immunity to surges	Conforming to IEC/EN 61000-4-5
Consumption	150 mA at 24 V input

Physical characteristics	
Dimensions	72 x 105 x 71 mm (2.83 x 4.13 x 2.79 in.)
Mounting	DIN rail
Weight	182.5 g (0.41 lb)
Degree of protection of the installed I/O application module	On the front panel (wall mounted enclosure): IP4x Connectors: IP2x Other parts: IP3x
Connections	Screw type terminal blocks

Technical characteristics - 24 V DC power supply	
Power supply type	Regulated switch type
Rated power	72 W
Input voltage	100–120 V AC for single phase 200–500 V AC phase-to-phase
PFC filter	With IEC 61000-3-2
Output voltage	24 V DC
Power supply out current	3 A

**Note:** it is recommended to use an UL listed/UL listed recognized limited voltage/Limited current or a class 2 power supply with a 24 V DC, 3 A maximum.

### IFE interface, IFE switchboard server web page description

Monitoring web page	
Real time data	■
Device logging	■

Control web page	
Single device control	■

Diagnostics web page	
Statistics	■
Device information	■
IMU information	■
Read device registers	■
Communication check	■

Maintenance web page	
Maintenance log	■
Maintenance counters	■

Setup web page	
Device localization/name	■
Ethernet configuration (dual port)	■
IP configuration	■
Modbus TCP/IP filtering	■
Serial port	■
Date and time	■
E-mail server configuration	■
Alarms to be e-mailed	■
Device list	■
Device logging	■
Device log export	■
SNMP parameters	■
Documentation links	■
Preferences	■
Advanced services control	■
User accounts	■
Web page access	■

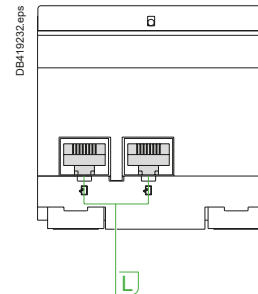
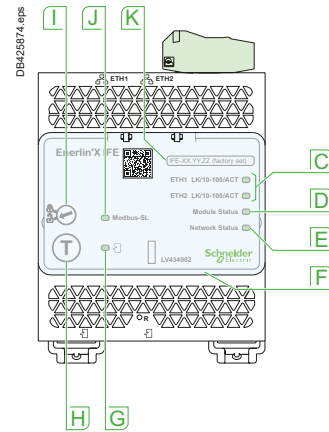
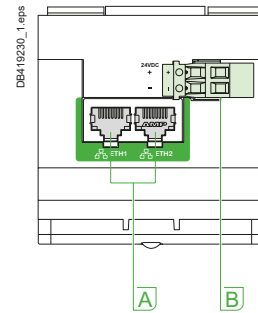

- A** Ethernet 1 and Ethernet 2 communication port.
- B** 24 Vdc power supply terminal block.
- C** Ethernet communication LEDs:  
yellow: 10 Mb  
green: 100 Mb.
- D** Module status LED:  
steady off: no power  
steady green: device operational  
steady red: major fault  
flashing green: standby  
flashing red: minor fault  
flashing green/red: self-test.
- E** Network status LED:  
steady off: no power/no valid IP address  
steady green: connected, valid IP address  
steady orange: default IP address  
steady red: duplicated IP address  
flashing green/red: self-test.
- F** Sealable transparent cover.
- G** ULP status LED.
- H** Test button (accessible closed cover).
- I** Locking pad.
- J** Modbus traffic status LED (LV434002 only).
- K** Device name label.
- L** ULP ports.





IFM Modbus communication interface.  
Ref.: LV434000.

### Function

IFM - Modbus communication interface - is required for connection of a **MasterPact** or **ComPact** to a Modbus network as long as this circuit breaker is provided with a ULP (Universal Logic Plug) port. The port is available on respectively a BCM ULP or BSCM embedded module.

The IFM is defined as an IMU (Intelligent Modular Unit) in the ULP connection System documentation.

Once connected, the circuit breaker is considered as a slave by the Modbus master. Its electrical values, alarm status, open/close signals can be monitored or controlled by a Programmable Logic Controller or any other system.

### Characteristics

#### ULP port

2 RJ45 sockets, internal parallel wiring.

- Connection of a single circuit breaker (eventually via its I/O application module).
- A ULP line terminator or an FDM121 display unit must be connected to the second RJ45 ULP socket.

The RJ45 sockets deliver a 24 VDC supply fed from the Modbus socket.

Built-in test function, for checking the correct connection to the circuit breaker and FDM121 display unit.

#### Modbus slave port

■ Top socket for screw-clamp connector, providing terminals for:

- 24 VDC input supply (0V, +24V)
- Modbus line (D1, D2, Gnd).

■ Lateral socket, for Din-rail stackable connector.

■ Both top and lateral sockets are internally parallel wired.

■ Multiple IFM can be stacked, thus sharing a common power supply and Modbus line without individual wiring.

■ On the front face:

- Modbus address setting (1 to 99): 2 coded rotary switches
- Modbus locking pad: enables or disable the circuit breaker remote control and modification of IFM parameters.
- Self adjusting communication format (Baud rate, parity).

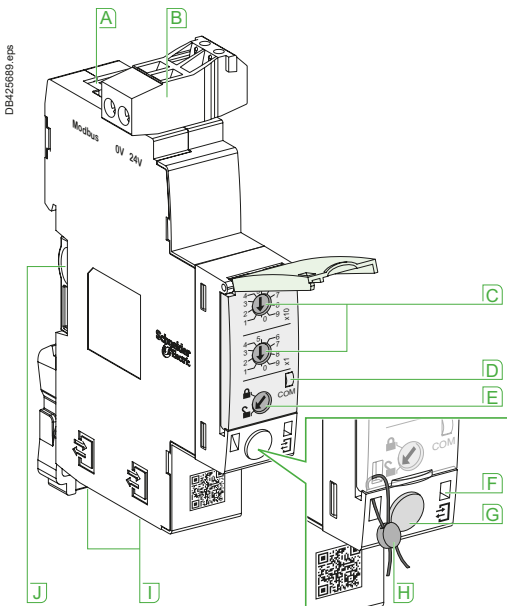

- A** Modbus Serial RJ45 port.
- B** 0-24 V DC power supply.
- C** Modbus address switches.
- D** Modbus traffic LED.
- E** Modbus locking pad.
- F** ULP activity LED.
- G** Test button.
- H** Mechanical lock and locking seal.
- I** ULP RJ45 connectors.
- J** Stacking accessory connection.

### Catalog numbers

IFM Modbus communication interface			
Type	Set of	Cat. no.	
IFM -Modbus communication interface module	-	LV434000	
Connector modbus adaptor	-	LV434211	
Stacking accessories if more than 1 IFM	10	TRV00217	
ULP line terminator	-	TRV00880	

### Technical characteristics

IFM Modbus communication interface			
Dimensions		18 x 72 x 96 mm	
Maximum number of stacked IFM		12	
Degree of protection of the installed module	Part projecting beyond the escutcheon	IP4x	
	Other module parts	IP3x	
	Connectors	IP2x	
Operating temperature		-25...+70°C	
Power supply voltage		24 V DC -20 %/+10 % (19.2...26.4 V DC)	
Consumption	Typical	21 mA/24 V DC at 20°C	
	Maximum	30 mA/19.2 V DC at 60°C	
Certification			
CE	IEC/EN 60947-1		
UL	UL 508 - Industrial Control Equipment		
CSA	No. 142-M1987 - Process Control Equipment CAN/CSA C22.2 No. 0-M91 - General requirements - Canadian Electrical Code Part CAN/CSA C22.2 No. 14-05 - Industrial Control Equipment		

### Simplified IFM installation

#### Stacking IFM

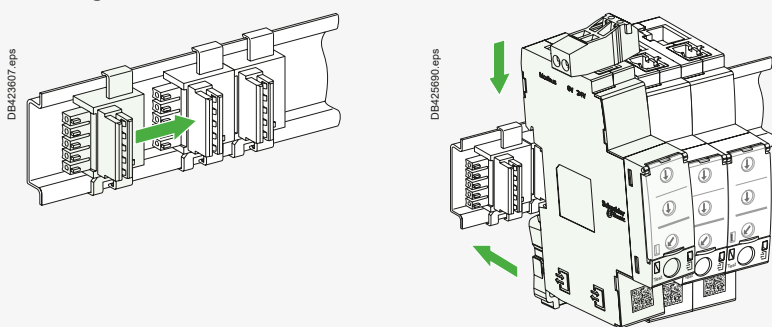

#### Stacking accessories

Up to 12 stacked IFM

#### Stacking an IFE interface + gateway with IFMs

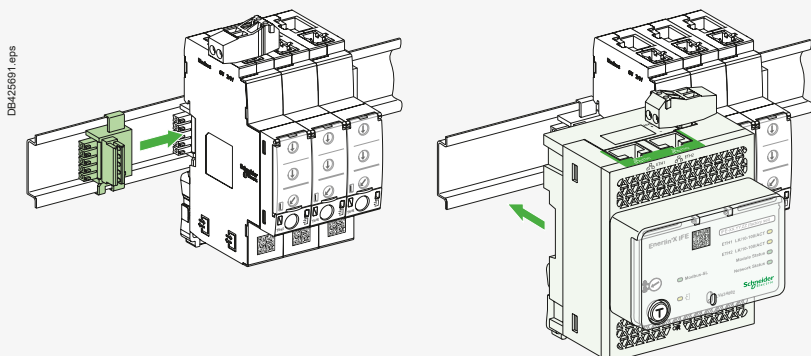

# Components

## I/O Application module



I/O application module.

D

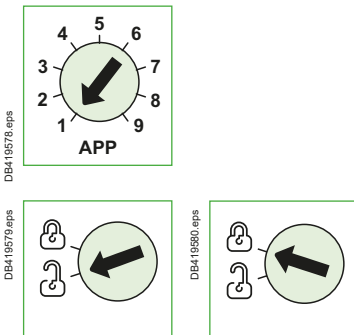

### I/O application module description

#### Description

The I/O input/output application module for LV breaker is one of the components of ULP architecture. Built in functionalities and applications enhance control and monitoring needs.

ULP system architecture including I/O modules can be built without any restrictions using a wide range of circuit breakers:

- MasterPact MTZ1/MTZ2/MTZ3,
- ComPact NS1600b-3200,
- ComPact NS630b-1600,
- ComPact NSX100-630 A.

The I/O application module is compliant with the ULP system specifications. Two I/O application modules can be connected in the same ULP architecture.

#### I/O input/output interface for LV breaker resources

The I/O application module resources are the following:

- 6 digital inputs that are self powered for either NO and NC dry contact or pulse counter,
- 3 digital outputs that are bistable relay (5 A maximum),
- 1 analog input for Pt100 temperature sensor.

#### Pre-defined applications

Pre-defined applications improve the IMU approach (Intelligent Modular Unit) in a simple way.

A 9-position rotary switch on the front of the I/O module allows to select the pre-defined applications. Each position is assigned to a pre-defined application except position 9 which allows the user to define a specific application by means of the customer engineering tool. The switch is set in factory to the pre-defined application 1.

For each application the input/output assignment and the wiring diagram are pre-defined. No additional setting with the customer engineering tool is required. The I/O and other resources not assigned to the pre-defined applications are free for user specific applications.

#### User applications

The user applications with the corresponding resources are defined by means of EcoStruxure Power Commission engineering tool. They use the resources not assigned to the predefined applications. User applications may be required for:

- Protection improvement,
- Circuit breaker control,
- Motor control,
- Energy management,
- Monitoring.

#### 24 Vdc power supply

The I/O module can be supplied with a 24 Vdc AD power supply or with any other 24 Vdc power supply having the same characteristics.

#### Mounting

The I/O is a DIN rail mounting device.

**Note:** The connection of the +/- of the power supply on +/- terminals of the I/O module must be strictly respected. Crossing the polarities may damage the device.

### Setting locking pad

The setting locking pad on the front panel of the I/O enables the setting of the I/O by EcoStruxure Power Commission engineering tool.



# Smart Panel integration Components I/O Application module

## General characteristics

### Environmental characteristics

Conforming to standards	UL 508, UL 60950, IEC 60950, IEC 60947-6-2
Certification	cULus, GOST, FCC, CE
Ambient temperature	-20 to +70 °C (-4 to +158 °F)
Relative humidity	5 - 85 %
Level of pollution	Level 3
Flame resistance	ULV0 conforming to IEC/EN 60068-2-30

### Mechanical characteristics

Shock resistance	1000 m/s <sup>2</sup>
Resistance to sinusoidal vibrations	5 Hz < f < 8.4 Hz

### Electrical characteristics

Resistance to electromagnetic discharge	Conforming to IEC/EN 61000-4-3
Immunity to radiated fields	10 V/m
Immunity to surges	Conforming to IEC/EN 61000-4-5
Consumption	165 mA

### Physical characteristics

Dimensions	71.7 x 116 x 70.6 mm
Mounting	DIN rail
Weight	229.5 g (0.51 lb)
Degree of protection of the installed I/O application module	On the front panel (wall mounted enclosure): IP4x I/O parts: IP3x Connectors: IP2x
Connections	Screw type terminal blocks

### Digital inputs

Digital input type	Self powered digital input with current limitations as per IEC 61131-2 type 2 standards (7 mA)
Input limit values at state 1 (close)	19.8 - 25.2 V DC, 6.1 - 8.8 mA
Input limit values at state 0 (open)	0 - 19.8 V DC, 0 mA
Maximum cable length	10 m (33 ft)

**Note:** for a length greater than 10 m (33 ft) and up to 300 m (1.000 ft), it is mandatory to use a shielded twisted cable. The shield cable is connected to the I/O functional ground of the I/O application module.

### Digital outputs

Digital output type	Bistable relay
Rated load	5 A at 250 Vac
Rated carry current	5 A
Maximum switching voltage	380 Vac, 125 Vdc
Maximum switch current	5 A
Maximum switching power	1250 VA, 150 W
Minimum permissible load	10 mA at 5 V DC
Contact resistance	30 mΩ
Maximum operating frequency	18000 operations/hr (Mechanical) 1800 operations/hr (Electrical)
Digital output relay protection by an external fuse	External fuse of 5 A or less
Maximum cable length	10 m (33 ft)

### Analog inputs

I/O application module analog input can be connected to a Pt100 temperature sensor.

Range	-30 to 200 °C	-22 to 392 °F
Accuracy	±2 °C from -30 to 20 °C ±1 °C from 20 to 140 °C ±2 °C from 140 to 200 °C	±3.6 °F from -22 to 68 °F ±1.8 °F from 68 to 284 °F ±3.6 °F from 284 to 392 °F
Refresh interval	5 s	5 s

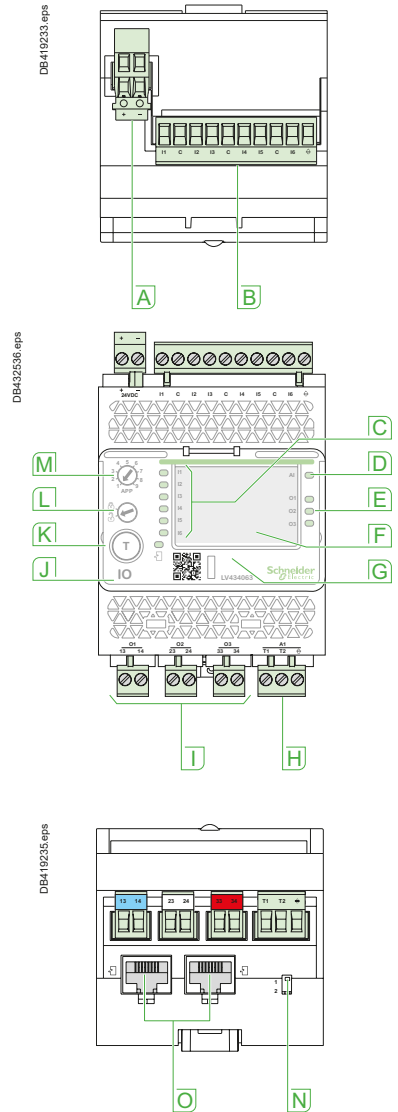

- A** 24 Vdc power supply terminal block.
- B** Digital input terminal block: 6 inputs, 3 commons and 1 shield.
- C** 6 input status LEDs.
- D** Analog input status LED.
- E** 3 output status LEDs.
- F** I/O application module identification labels.
- G** Sealable transparent cover.
- H** Analog input terminal block.
- I** Digital output terminal blocks.
- J** ULP status LED.
- K** Test/reset button (accessible with cover closed).
- L** Setting locking pad.
- M** Application rotary switch: 1 to 9.
- N** Switch for I/O addressing (I/O 1 or I/O 2).
- O** ULP connectors.



# Customer engineering tool: EcoStruxure Power Commission software

## EcoStruxure Power Commission Experience

### Project Lifecycle

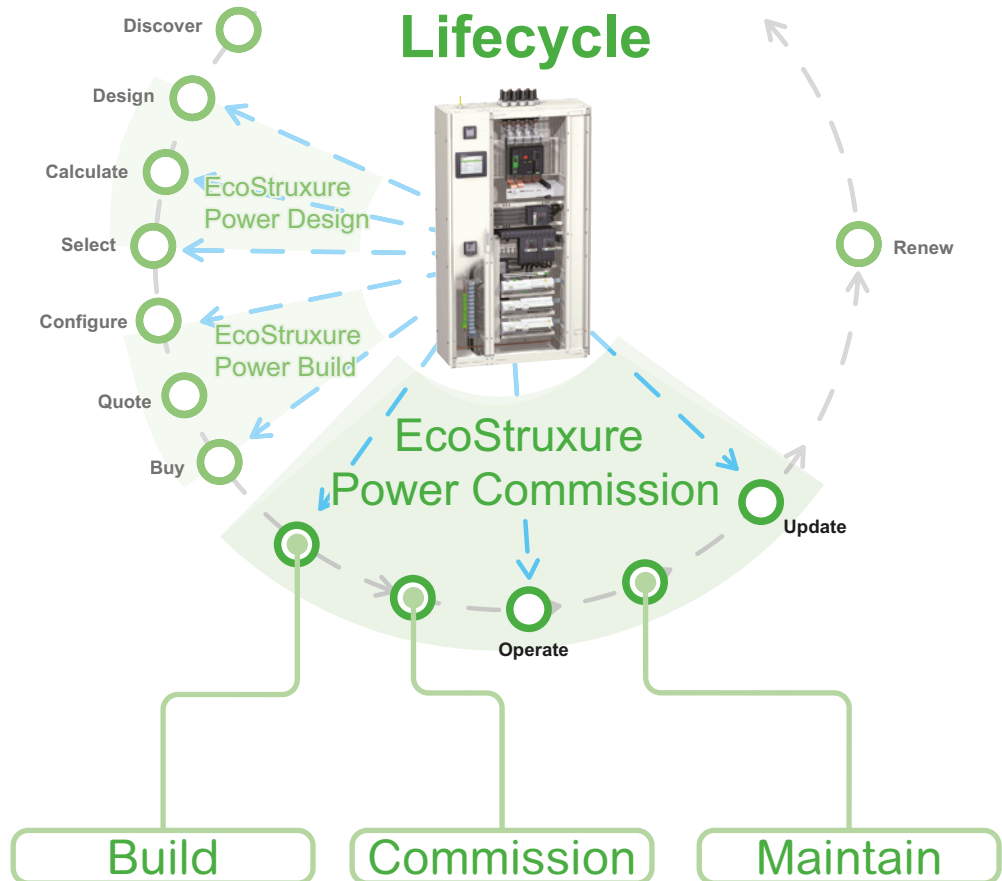

#### Key Features

##### Build

I want to test & deliver a “ready to commission” panel

- Device Discovery
- Switchboard setting & testing
- Communication Test & Reports
- Save my project & reports

##### Commission

I want to “shorten” my commissioning time

- Device Discovery
- Multi Device Configuration
- Communication Test & Reports
- Save my project & reports

##### Maintain

I want to ensure “continuity” of services in “safe conditions”

- Settings consistency check
- Firmware upgrade
- Standard Diagnostic data
- Save my project & reports

#### Build



Panel builders

Simple & easy software to set up and test a panelboard with smart phones

#### Commission



Electrical contractors & system integrator

Shorten commissioning time and speed up SAT delivery with easy-to-use software

#### Maintain



Facility managers

Software to track installation changes & diagnostic features for preventive maintenance

D

# Customer engineering tool: EcoStruxure Power Commission software

## Operation and Maintenance

- Devices monitoring and control.
- Measurement parameter logs.
- Log reports.
- Download of current devices settings, compare with previous settings saved in EcoStruxure Power Commission.
- Firmware upgrade and compatibility matrix.

## Compatibility

### Devices

Configuration of below devices through the range of Enerlin'X interfaces devices.

- Circuit breakers: MasterPact MTZ, ComPact NSX ranges.
- Circuit breakers and control components: Acti 9 range.

### EcoStruxure Power Commission software for PC

- Compatible with Windows XP pro, Windows Seven.

## Example of EcoStruxure Power Commission win

Browsing tabs

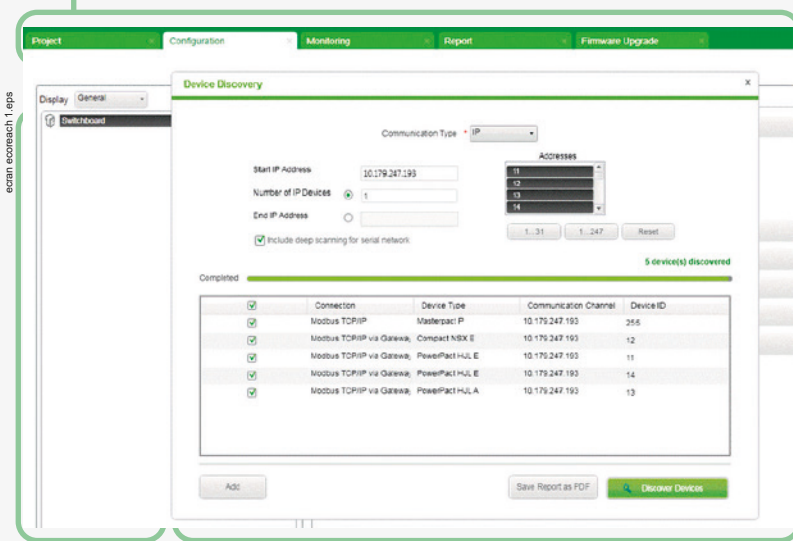

Smart Panels architecture

Contextual window, for monitoring, settings...

### Key Features:

- Device Discovery: EcoStruxure Power Commission helps the user to discover the communicating devices in a switchboard either through Ethernet or a serial network. Once the devices in the switchboard are discovered, the user can add those devices to the project area.
- Communication Test: When a user has installed communicating devices in a switchboard, EcoStruxure Power Commission offers the capability to test the communication network. Once a communication test is done, the user can generate a time stamped communication test report.
- Reports: EcoStruxure Power Commission offers the following reports to the users
  - Communication Test Report.
  - Comprehensive project report.
  - Logs and trip history reports.
- Firmware Upgrade: EcoStruxure Power Commission offers the compatibility check and firmware upgrade for the following devices.
  - MicroLogic X control units,
  - EIFE / IFE,
  - I/O modules.





# Switchboard integration

- ComPact NSX & NSXm**
  - Operating and installation conditions ..... E-4
  - Safety clearances and minimum distances ..... E-10
  - Voltage release wiring rules ..... E-12
  - Power loss / Resistance ..... E-13
- ComPact NSX temperature derating**
  - Equipped with thermal-magnetic trip units ..... E-14
  - Equipped with electronic trip units ..... E-16
- ComPact NSX installation in switchboards**
  - Safety clearances and minimum distances ..... E-18
  - Installation example ..... E-19
  - Control wiring ..... E-20
- Power supplies ..... E-21**
- ComPact NSX power loss/ resistance**
  - Equipped with thermal-magnetic trip units ..... E-23
  - Equipped with electronic trip units ..... E-24



<b>Other chapters</b>	
Select your circuit breakers and switch-disconnectors .....	A-1
Select your protection .....	B-1
Customize your circuit breaker with accessories .....	C-1
Smart Panel integration .....	D-1
Catalog numbers .....	F-1
Glossary .....	G-1
Additional characteristics .....	H-1

## Switchboard integration

<b>ComPact NSXm dimensions and mounting</b>	
Circuit breaker and switch-disconnector .....	E-25
<b>ComPact NSX dimensions and mounting</b>	
ComPact NSX100 to NSX250 fixed version, 1P-2P .....	E-34
ComPact NSX100 to 630 fixed version.....	E-36
ComPact NSX100 to 630 Vigi add-on fixed version.....	E-37
ComPact NSX100 to 630 plug-in version .....	E-38
ComPact NSX100 to 630 withdrawable version.....	E-40
ComPact NSX100 to 630 Vigi add-on plug-in and withdrawable versions .....	E-42
Visu function for ComPact NSX100 to 250 fixed version.....	E-43
Visu function for ComPact NSX400/630 fixed version.....	E-44
Motor mechanism module for ComPact NSX100 to 630 .....	E-45
Direct rotary handle for ComPact NSX100 to 630.....	E-46
MCC and CNOMO type direct rotary handles for ComPact NSX100 to 630 fixed version .....	E-47
Extended rotary handle for ComPact NSX100 to 630.....	E-48
Indication and measurement modules for ComPact NSX100 to 630 fixed version .....	E-49
One-piece spreader for ComPact NSX100 to 250 fixed version ..	E-50
External modules .....	E-51
FDM121 switchboard display.....	E-52
FDM128 switchboard display.....	E-53
<b>ComPact NSX front-panel accessories</b>	
ComPact NSX100 to 630 .....	E-54
<b>ComPact NSX front-panel cutouts</b>	
ComPact NSX100 to 630 fixed version.....	E-56
ComPact NSX100 to 630 Vigi add-on fixed version.....	E-58
ComPact NSX100 to 630 plug-in and withdrawable versions .....	E-60
ComPact NSX100 to 630 Vigi add-on plug-in and withdrawable versions.....	E-61
Visu function for ComPact NSX100 to 630 fixed version.....	E-62
Motor mechanism module for ComPact NSX100 to 630 with/without Vigi add-on.....	E-63
Direct rotary handle for ComPact NSX100 to 630 with/without Vigi add-on.....	E-64
Indication and measurement modules for ComPact NSX100 to 630 .....	E-66

### Other chapters

Select your circuit breakers and switch-disconnectors .....	A-1
Select your protection .....	B-1
Customize your circuit breaker with accessories .....	C-1
Smart Panel integration.....	D-1
Catalog numbers .....	F-1
Glossary .....	G-1
Additional characteristics .....	H-1

## Switchboard integration

### ComPact NSX power connections

ComPact NSX100 to 630 with/without Vigi add-on fixed version ..	E-68
ComPact NSX100 to 630 with/without Vigi add-on plug-in and withdrawable versions .....	E-72
Connection of insulated bars or cables with lugs to ComPact NSX100 to 630 with/without Vigi add-on .....	E-76
Connection of bare cables to ComPact NSX100 to 630 with/without Vigi add-on.....	E-77

### ComPact NSXm

Auxiliaries .....	E-78
SDx module for MicroLogic Vigi 4.1 (ELCB) .....	E-79
Communication .....	E-80

### ComPact NSX

Fixed circuit breakers .....	E-81
Plug-in / withdrawable circuit breakers .....	E-83
Motor mechanism .....	E-85
SDx module with MicroLogic.....	E-87
SDTAM module with MicroLogic M .....	E-88
Communication .....	E-89



#### Other chapters

Select your circuit breakers and switch-disconnectors .....	A-1
Select your protection .....	B-1
Customize your circuit breaker with accessories.....	C-1
Smart Panel integration.....	D-1
Catalog numbers .....	F-1
Glossary .....	G-1
Additional characteristics .....	H-1

# ComPact NSX & NSXm

## Operating and installation conditions

ComPact NSXm may be mounted vertically, horizontally or flat on their back or on their side without any derating of characteristics.



ComPact NSXm.



### Fixed circuit breakers

ComPact NSXm may be mounted vertically, horizontally or flat on their back or on their side without any derating of characteristics. These devices can be mounted on a DIN rail using the integrated DIN rail mounting feature.

For backplate mounting, the devices are supplied with two mounting screws (M4), washers and nuts. These mounting screws can be inserted through mounting holes molded into the device case and threaded into the mounting enclosure, rails or plate.

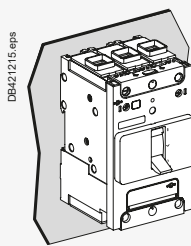

Mounting on a backplate.

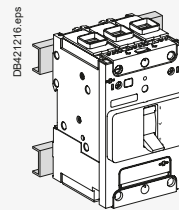

Mounting on rails.

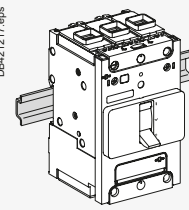

Mounting on DIN rail.

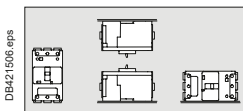

Fixed device installation positions.

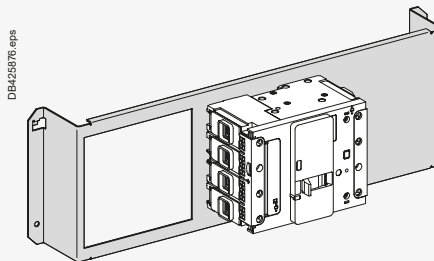

Mounting on a Prisma mounting plate.



# ComPact NSX & NSXm

## Operating and installation conditions

ComPact NSX circuit breakers may be installed horizontally, vertically or flat on their back, without derating performance levels.

There are three installation versions:

- fixed
- plug-in (on a base)
- withdrawable (on a chassis).

For the last two, components must be added (base, chassis) to the fixed version. Many connection components are shared by the three versions.

### Fixed circuit breakers

Fixed circuit breakers are designed for standard connection using bars or cables with lugs. Bare-cable connectors are available for connection to bare copper or aluminium cables.

For connection of large cables, a number of solutions with spreaders may be used for both cables with lugs or bare cables.

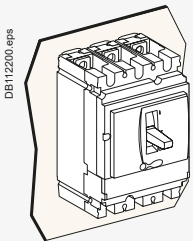

DB112200.eps

Mounting on a backplate.

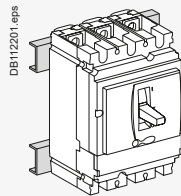

DB112201.eps

Mounting on rails.

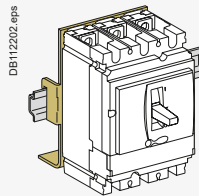

DB112202.eps

Mounting on DIN rail (with adapter).

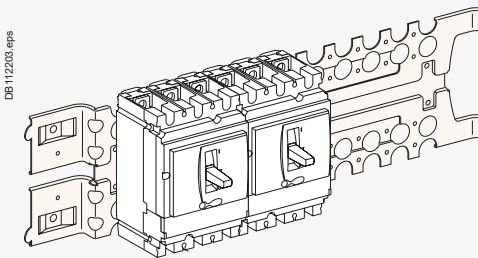

DB112203.eps

Mounting on a Prisma mounting plate.

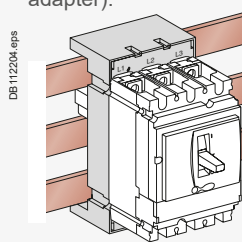

DB112204.eps

Mounting on busbars with an adapter.



PB105112.eps

Fixed ComPact NSX250.

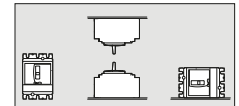

Fixed device installation positions.

DB112208.eps



PB105121.eps

Plug-in ComPact NSX250.

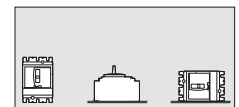

Withdrawable device installation positions.

DB112209.eps



# ComPact NSX & NSXm

## Operating and installation conditions

DB42544.eps

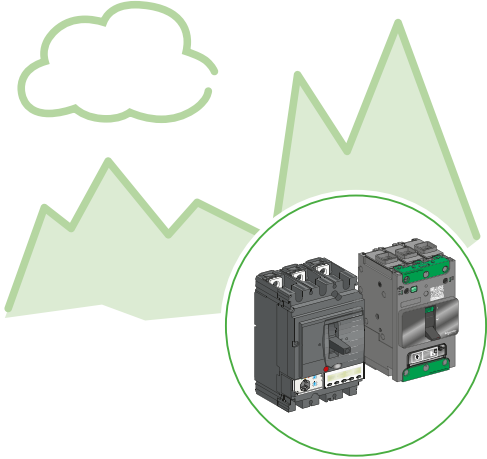

DB425435.eps

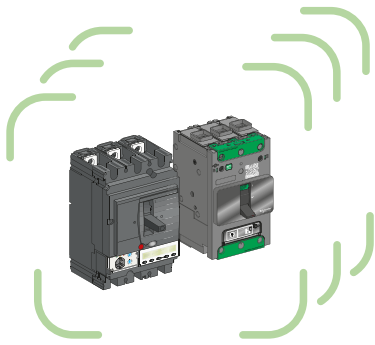

E

DB425436.eps

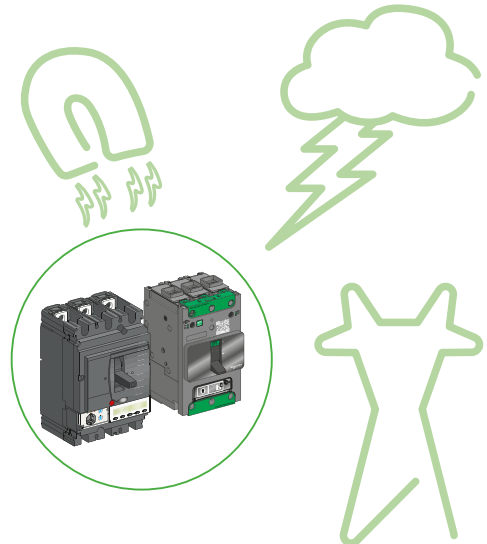

### Altitude derating

Altitude does not significantly affect the characteristics of ComPact NSX and NSXm circuit breakers up to 2000 m. Above this altitude, it is necessary to take into account the decrease in the dielectric strength and cooling capacity of air. The following table gives the corrections to be applied for altitudes above 2000 m. The breaking capacities remain unchanged.

Altitude (m)		2000	3000	4000	5000
Impulse withstand voltage (kV)		8	7.1	6.4	5.6
Insulation voltage (V)	Ui	800	710	635 <sup>[1]</sup>	560
for ELCB <sup>[3]</sup>	Ui	500	445	400	350
Maximum operational voltage (V)	Ue	690	690	635 <sup>[1]</sup>	560
for ELCB <sup>[3]</sup>	Ue	440	440	400	350
Average current capacity (A) at 40 °C	In x	1.0	0.98 <sup>[2]</sup>	0.96	0.94

### Vibrations

ComPact NSX and NSXm devices resist mechanical vibrations. They meet IEC 60068-2-6:

- 2.0 to 13.2 Hz and amplitude ±1 mm
- 13.2 to 100 Hz acceleration ±0.7 g.

Excessive vibration may cause tripping, breaks in connections or damage to mechanical parts.

### Electromagnetic disturbances

ComPact NSX and NSXm devices are protected against:

- overvoltages caused by circuit switching
- overvoltages caused by an atmospheric disturbances or by a distribution-system outage (e.g. failure of a lighting system)
- devices emitting radio waves (radios, walkie-talkies, radar, etc.)
- electrostatic discharges produced directly by users.

ComPact NSX and NSXm devices have successfully passed the electromagnetic-compatibility tests (EMC) defined by the international standards listed [page A-15](#).

These tests ensure that:

- no nuisance tripping occurs
- tripping times are respected.

[1] 640 for ComPact NSX.

[2] 0.99 for ComPact NSX.





[3] Earth Leakage Circuit Breaker.

# ComPact NSX & NSXm

## Operating and installation conditions

### Protection degree

Protection degree of the product, according to IEC 60529, depends of its configuration:

Colours	Definition
	IP54/65: side / front extended rotary handle
	IP40: front cover, side, back, long terminal shield, direct rotary handle
	IP20: power connection cover
	may be IP20 or less depending of the kind of power connections and cable size used



### Power supply from the top or bottom

ComPact NSXm circuit breakers can be supplied from either the top or the bottom, even when equipped with a MicroLogic Vigi 4.1 with integrated earth leakage protection, without any reduction in performance. This capability facilitates connection when installed in a switchboard.

All connection and insulation accessories can be used on circuit breakers supplied either from the top or bottom.



### Power supply from the top or bottom<sup>[1]</sup>

ComPact NSX circuit breakers can be supplied from either the top or the bottom, even when equipped with a Vigi add-on, without any reduction in performance. This capability facilitates connection when installed in a switchboard.

All connection and insulation accessories can be used on circuit breakers supplied either from the top or bottom.

<sup>[1]</sup> All R, HB1, and HB2 circuit breakers are restricted for use as line-load connection. They can not have power fed into the bottom of the circuit breaker. They will be marked with Line and Load markings.

### Weight

The table below presents the weights (in kg) of the circuit breakers and the main accessories, which must be summed to obtain the total weight of complete configurations. The values are valid for all performance categories.

Type of device	Circuit breakers	Base	Chassis	Vigi add-on	Visu module	Motor mech.	
NSX100	3P/2D	1.79	0.8	2.2	0.87	2	1.2
	3P/3D	2.05	0.8	2.2	0.87	2	1.2
	4P/4D	2.4	1.05	2.2	1.13	2.2	1.2
NSX160	3P/2D	1.85	0.8	2.2	0.87	2	1.2
	3P/3D	2.2	0.8	2.2	0.87	2	1.2
	4P/4D	2.58	1.05	2.2	1.13	2.2	1.2
NSX250	3P/2D	1.94	0.8	2.2	0.87	2	1.2
	3P/3D	2.4	0.8	2.2	0.87	2	1.2
	4P/4D	2.78	1.05	2.2	1.13	2.2	1.2
NSX400/630	3P/3D	6.19	2.4	2.2	2.8	4.6	2.8
	4P/4D	8.13	2.8	2.2	3	4.9	2.8

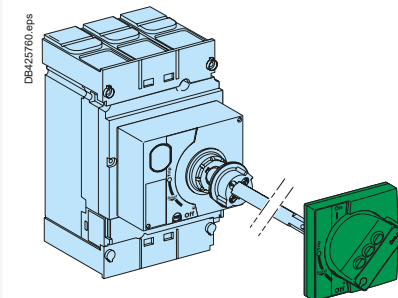
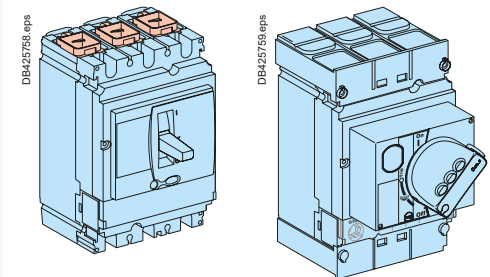
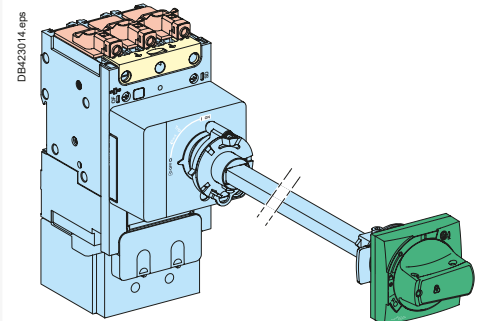
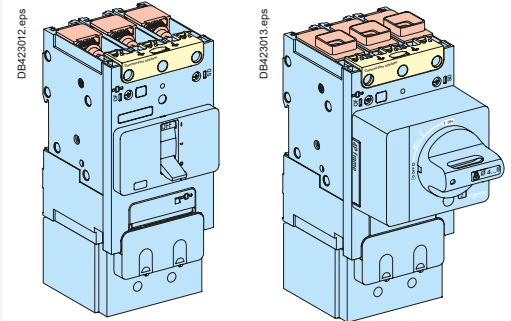

# ComPact NSXm

## Operating and installation conditions

### Derating and correction factor depending of temperature

The overload protection is calibrated at 40 °C in the lab. This means that when the ambient temperature is less or greater than 40 °C, the Ir protection pick-up is slightly modified.

#### Choosing the right rating depending of the temperature:

Over the reference temperature of 40 °C, the circuit breaker has to be derated following the table below:

#### Temperature derating for thermal-magnetic (TM-D) NSXm at In

Temperature °C						
40	45	50	55	60	65	70
Rating (A) In						
16	16	15	15	14	14	13
25	24	24	23	23	22	21
32	31	30	30	29	28	27
40	39	38	37	36	34	33
50	49	48	46	45	44	42
63	61	60	58	56	54	53
80	77	73	70	67	64	60
100	96	94	90	87	83	80
125	120	117	113	109	104	100
160	155	149	144	139	133	126

#### Temperature derating for NSXm with MicroLogic Vigi 4.1 at In

Temperature °C						
40	45	50	55	60	65	70
Rating (A) In						
25	25	25	25	25	25	25
50	50	50	50	50	50	50
100	100	100	100	100	100	100
160	155	150	145	140	135	130

### Doing the setting or calculating the tripping time for a given temperature:

After having determine the corrected ratio  $I/I_n$ , the tripping time at 40 °C is defined with the tripping curves (see pages H-2 to H-3).

To obtain the right setting or the tripping time at a different temperature, the ratio  $I/I_n$  has to be corrected with the correction factor below:

Correction factor table for thermal magnetic (TM-D) NSXm to determine setting or tripping time at $I_n$													
Rating (A) $I_n$	Temperature °C												
	10	15	20	25	30	35	40	45	50	55	60	65	70
16	1.16	1.13	1.11	1.08	1.05	1.03	1.00	0.97	0.94	0.91	0.88	0.85	0.81
25	1.13	1.11	1.09	1.07	1.05	1.02	1.00	0.98	0.95	0.93	0.90	0.88	0.85
32	1.14	1.11	1.09	1.07	1.05	1.02	1.00	0.98	0.95	0.93	0.90	0.87	0.84
40	1.15	1.12	1.10	1.08	1.05	1.03	1.00	0.97	0.95	0.92	0.89	0.86	0.83
50	1.13	1.11	1.09	1.07	1.05	1.02	1.00	0.98	0.95	0.93	0.90	0.87	0.85
63	1.14	1.12	1.10	1.07	1.05	1.02	1.00	0.97	0.95	0.92	0.89	0.86	0.83
80	1.21	1.18	1.14	1.11	1.07	1.04	1.00	0.96	0.92	0.88	0.83	0.80	0.75
100	1.18	1.16	1.12	1.10	1.06	1.04	1.00	0.96	0.94	0.90	0.87	0.83	0.80
125	1.17	1.14	1.11	1.08	1.06	1.03	1.00	0.96	0.93	0.90	0.87	0.84	0.80
160	1.17	1.15	1.12	1.09	1.06	1.03	1.00	0.97	0.93	0.90	0.87	0.83	0.79

### Doing the right setting depending of the temperature:

Example: What is the setting to obtain a real  $I_r$  of 105 A, taking into account the temperature, for a ComPact NSXm 125 A?

The necessary dial setting, in amperes, is shown below.

- At 40 °C,  $I_r = 105 / 1 = 105$  A
- At 20 °C,  $I_r = 105 / 1.11 = 95$  A
- At 60 °C,  $I_r = 105 / 0.87 = 121$  A.

### Calculating the tripping time at $I_r = I_n$ for a given temperature:

Example: What is the tripping time of a ComPact NSXm 100A at  $I_r = I_n$  for an overload of 500 A?

- At 40 °C,  $I/I_r = 5$ , tripping time is between 6 and 60 seconds
- At 20 °C,  $I/I_r = 5 / 1.12 = 4.46$ , tripping time is between 8 and 80 seconds
- At 60 °C,  $I/I_r = 5 / 0.87 = 5.75$ , tripping time is between 5 and 50 seconds

For  $I_r = 0.7$  to  $0.9 I_n$ , additional correction factor need to be applied - please consult us.

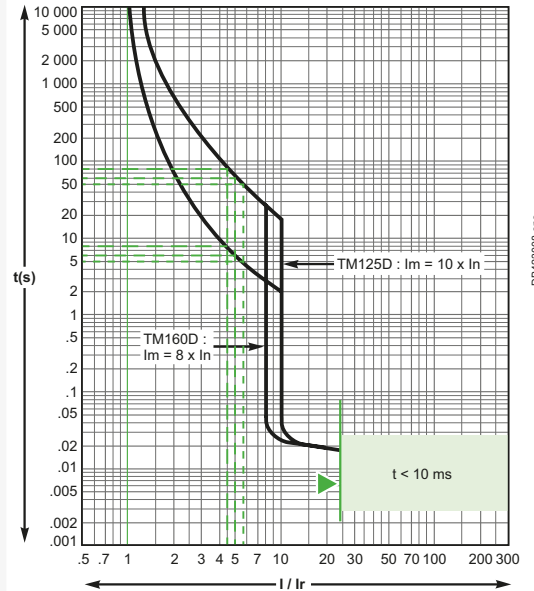

DB423008.eps



# ComPact NSXm

## Safety clearances and minimum distances

### General rules

When installing a circuit breaker, minimum distances (safety clearances) must be maintained between the device and panels, bars and other protection devices installed nearby. These distances, which depend on the ultimate breaking capacity, are defined by tests carried out in accordance with standard IEC 60947-2.

If installation conformity is not checked by type tests, it is also necessary to:

- use insulated bars for circuit-breaker connections
- segregate the busbars using insulating screens.

For ComPact NSXm devices, terminal shields and interphase barriers are recommended and may be mandatory depending on the kind of power connections of the device and type of installation.

### Power connections

The table below indicates the rules to be respected for ComPact NSXm devices to ensure insulation of live parts for the various types of connection.



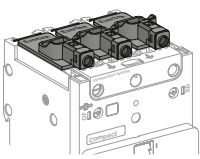
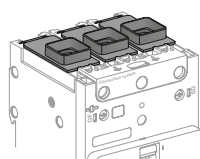
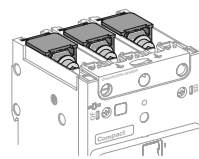

Connection accessories such as crimp lugs, power distribution connectors, and spreaders are supplied with interphase barriers.

Long terminal shields provide a degree of protection of IP40 (ingress) and IK07 (mechanical impact).

### ComPact NSXm: rules to be respected to ensure insulation of live parts

	EverLink connector with or without control wire terminal	Mechanical lug connector	Compression lug / busbar connector
	 DB421518 eps	 DB418827 eps	 DB421519 eps

### Insulation accessory options per conductor type

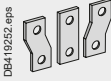
Type of conductor	No insulating accessory	Interphase barriers	Long terminal shield	No insulating accessory	Interphase barriers	Long terminal shield	No insulating accessory	Interphase barriers	Long terminal shield
Cables  DB419248 eps	Possible	-	-	Possible	Possible	Possible	-	-	-
Insulated bars  DB419249 eps	-	-	-	-	-	-	Possible [2]	Possible	Possible
Cables + crimp lugs  DB419250 eps	-	-	-	-	-	-	Forbidden	Mandatory [3]	Possible [1]
Cables + crimp lugs with heat-shrinkable sheath  DB419251 eps	-	-	-	-	-	-	Possible [2]	Possible	Possible
Extension terminals: spreader  DB419252 eps	-	-	-	-	-	-	Forbidden	Mandatory [4]	-

[1] Instead of phase barriers.

[2] Safety air clearance of 8 mm has to be respected between live parts.

[3] When > 5 mm clearance between devices Interphase barriers are mandatory otherwise for < 5 mm Long terminal shields are mandatory.

[4] When > 5 mm clearance between devices Interphase barriers are mandatory otherwise > 5 mm clearance between devices is forbidden.

**Note:** For uninsulated bar connections, please consult us.

# ComPact NSXm

## Safety clearances and minimum distances

### IEC standard

#### Minimum safety clearances

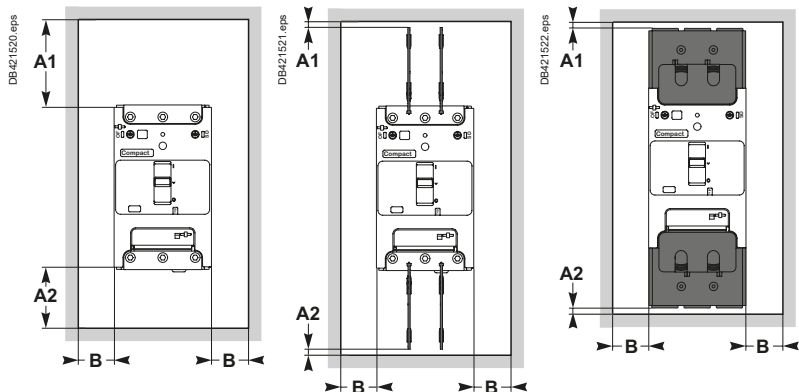

#### Minimum safety clearances to bare busbars

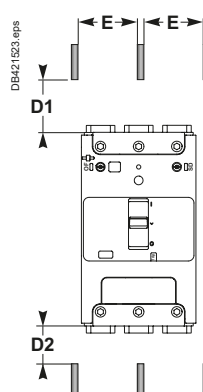

Operating voltage	Clearance (mm)						
	Between devices	Between device and sheet metal			Bare sheet metal		
		Painted sheet metal		Bare sheet metal			
$U \leq 690 \text{ V}$		A1	A2	B	A1	A2	B
for devices equipped with:							
no accessories	0	30 mm	5 mm	0	40 mm	5 mm	5 mm
interphase barriers [1]	0	0	0	0	0	0	5 mm
long terminal shields	0	0	0	0	0	0	5 mm

[1] 20 mm clearance when using spreaders and 5mm clearance when using crimp lugs between devices is mandatory.

Operating voltage	Clearances to live bare busbars [2]			
	Spacing $E \leq 60 \text{ mm}$		Spacing $E > 60 \text{ mm}$	
	D1	D2	D1	D2
$U \leq 690 \text{ V}$	200 mm	100 mm	120 mm	60 mm

[2] These clearances can be reduced for special installations as long as the configuration is checked by tests.

#### Compression lug safety clearance

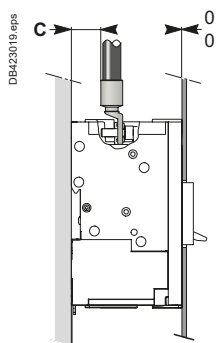

An insulating screen or long terminal shield is required if  $C < 8 \text{ mm}$ .



# ComPact NSXm

## Voltage release wiring rules

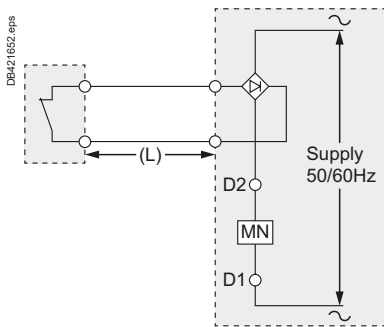
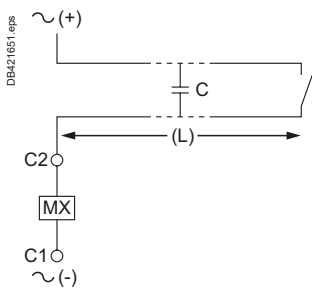
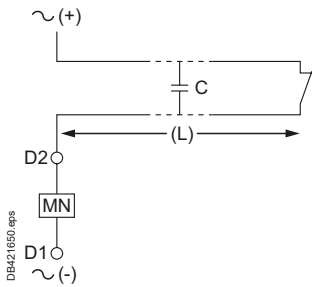

### Shunt trip (MX) and undervoltage release (MN)

#### Recommended maximum cable lengths

In certain circumstances, high cable capacitance due to an excessive cable length could prevent an undervoltage release MN from dropping out resulting in safety issues. In case of a shunt trip MX, an untimely trip may occur due to capacitive current leak.

To avoid these dysfunction due to cable capacitance C, the maximum cable length (L) is defined by the following table for a 1.5 mm<sup>2</sup> cable.

Power supply voltage (Un)	Maximum cable length undervoltage trip (MN) [1]	Shunt trip (MX) [1]
24 V AC	1 243 m	3 653 m
24 V DC	unlimited	> 3653 m
48 V AC	583 m	1 667 m
48 V DC	unlimited	> 1667 m
110...130 V AC	126 m	913 m
110...130 V DC	unlimited	> 913 m
208-240 V AC	109 m	160 m
250 V DC	unlimited	> 160 m
277 V AC	98 m	120 m
380-415 V AC	86 m	80 m
440-480 V AC	56 m	67 m

[1] Make sure auxiliaries supply voltage is within working range (0.85 Un mini...1.1 Un maxi).

If a longer cable length is required, several solutions are possible to counteract excessive cable capacitance:

- use DC operated auxiliaries
- use lower control voltage (make sure auxiliaries supply voltage is within working range: 0.85 Un minimum...1.1 Un maximum)
- if high voltage and long control cables are required for an AC undervoltage release (MN), add a rectifier bridge (ref LV426899 – DIN rail compatible) in the control circuit. It will prevent drop out problems but increase operating time.

#### Electrical characteristics of MN/MX

Characteristics			AC	DC
Rated voltage (V)			24, 48, 110...130, 208...240, 277, 380...415, 440...480	24, 48, 125, 250
Power requirements	MX	Pickup (< 50 ms)	< 6 VA	< 10 W
		Seal-in	< 4 VA	< 1 W
	MN		< 7 VA	< 2 W
Clearing time (ms)			< 50	< 50
Operating range			up to 1.1 Un	



ComPact NSXm thermal power loss values are used to calculate total temperature rise in the switchboard in which the circuit breakers are installed.

The values indicated in the tables below are typical values for a device at full rated load and 50/60 Hz.

#### Power loss per pole (P/pole) in Watts (W)

The value indicated is the power loss at  $I_n$ , 50/60 Hz, for a three-pole or four-pole circuit breaker. Measurement and calculation of power loss are carried out in compliance with the recommendations of Annex G of standard IEC 60947-2.

#### Resistance per pole (R/pole) in milliohms (mΩ)

The value of the resistance per pole is provided as a general indication for a new device.

The value of the contact resistance is determined on the basis of the measured voltage drop, in accordance with the manufacturer's test procedure.

**Note:** this measurement is not sufficient to determine the quality of the contacts, i.e. the capacity of the circuit breaker to carry its rated current.

#### Calculation of total power loss

Total power loss at full rated load and 50/60 Hz is equal to power losses per pole multiplied by the number of poles (3 or 4).

#### ComPact NSXm with TM-D

Rating (A)	R total / pole (mΩ)	P / Pole (W)
16	8.87	2.3
25	4.50	2.8
32	3.10	3.3
40	2.30	3.8
50	1.85	4.6
63	1.44	5.7
80	0.90	5.8
100	0.75	7.5
125	0.59	9.3
160	0.53	13.7

#### ComPact NSXm with MicroLogic Vigi 4.1

Rating (A)	R total / pole (mΩ)	P / Pole (W)
25	2.44	1.5
50	0.48	1.2
100	0.48	4.8
160	0.48	12.3

# ComPact NSX temperature derating

## Equipped with thermal-magnetic trip units

When thermal-magnetic trip units are used at ambient temperatures other than 40 °C, the Ir pick-up is modified.

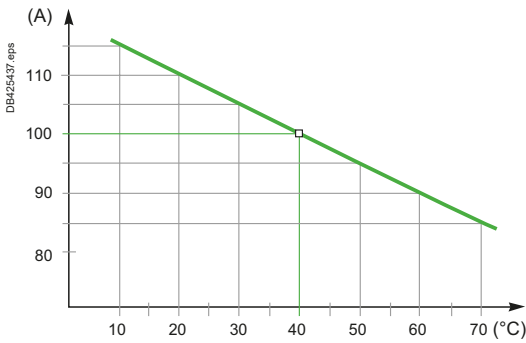

Temperature derating curve for ComPact NSX100.

### Derating and correction factor depending of temperature

The overload protection is calibrated at 40 °C in the lab. This means that when the ambient temperature is less or greater than 40 °C, the Ir protection pick-up is slightly modified.

#### Choosing the right rating depending of the temperature:

Over the reference temperature of 40 °C, the circuit breaker has to be derated following the table below:

Temperature derating for thermal-magnetic (TM-D) NSX at In						
Temperature °C						
40	45	50	55	60	65	70
Rating (A) In						
16	15.6	15.2	14.8	14.5	14	13.8
25	24.5	24	23.5	23	22	21
32	31.3	30.5	30	29.5	29	28.5
40	39	38	37	36	35	34
50	49	48	47	46	45	44
63	61.5	60	58	57	55	54
80	78	76	74	72	70	68
100	97.5	95	92.5	90	87.5	85
125	122	119	116	113	109	106
160	156	152	148	144	140	136
200	195	190	185	180	175	170
250	244	238	231	225	219	213

#### Doing the setting or calculating the tripping time for a given temperature:

After having determine the corrected ratio I/In, the tripping time at 40 °C is defined with the tripping curves (see pages H-5 to H-7).

To obtain the right setting or the tripping time at a different temperature, the ratio I/In has to be corrected with the correction factor below:

Correction factor table for thermal magnetic (TM-D) NSX to determine setting or tripping time at In													
Rating (A) In	Temperature °C												
	10	15	20	25	30	35	40	45	50	55	60	65	70
16	1.15	1.17	1.13	1.13	1.06	1.04	1.00	0.98	0.95	0.93	0.91	0.88	0.86
25	1.15	1.12	1.10	1.08	1.05	1.02	1.00	0.98	0.96	0.94	0.92	0.88	0.84
32	1.15	1.13	1.10	1.07	1.05	1.03	1.00	0.98	0.95	0.94	0.92	0.91	0.89
40	1.15	1.13	1.10	1.08	1.05	1.03	1.00	0.98	0.95	0.93	0.9	0.88	0.85
50	1.15	1.12	1.10	1.08	1.05	1.02	1.00	0.98	0.96	0.94	0.92	0.90	0.88
63	1.14	1.13	1.10	1.08	1.05	1.03	1.00	0.98	0.95	0.92	0.90	0.87	0.86
80	1.15	1.13	1.10	1.08	1.05	1.03	1.00	0.98	0.95	0.93	0.90	0.88	0.85
100	1.15	1.13	1.10	1.08	1.05	1.03	1.00	0.98	0.95	0.93	0.90	0.88	0.85
125	1.15	1.128	1.10	1.07	1.05	1.02	1.00	0.98	0.95	0.93	0.90	0.87	0.85
160	1.15	1.125	1.10	1.08	1.05	1.03	1.00	0.98	0.95	0.93	0.90	0.88	0.85
200	1.15	1.125	1.10	1.08	1.05	1.03	1.00	0.98	0.95	0.93	0.90	0.88	0.85
250	1.15	1.124	1.11	1.08	1.05	1.02	1.00	1.63	0.95	0.92	0.90	0.88	0.85

For Ir = 0.7 to 0.9 In, additional correction factor need to be applied - please consult us.

# ComPact NSX temperature derating

## Equipped with thermal-magnetic trip units

**Example 1.** What is the tripping time of a ComPact NSX100 equipped with a TM100D trip unit set to 100 A, for an overload  $I = 500$  A?  
 The overload  $I/I_r$  is calculated as a function of the temperature. Use the above values and the curve on page H-6 (shown on the left) to determine the corresponding time.

- At 40 °C,  $I_r = 100$  A,  $I/I_r = 5$  and the tripping time is between 6 and 60 seconds.
- At 20 °C,  $I_r = 110$  A,  $I/I_r = 4.54$  and the tripping time is between 8 and 80 seconds.
- At 60 °C,  $I_r = 90$  A,  $I/I_r = 5.55$  and the tripping time is between 5 and 50 seconds.

**Example 2.** What is the setting to obtain a real  $I_r$  of 210 A, taking into account the temperature, for a ComPact NSX250 equipped with a TM250D trip unit?  
 The necessary dial setting, in amperes, is shown below.

- At 40 °C,  $I_r = (210/250) \times 250$  A = 210 A
- At 20 °C,  $I_r = (210/277) \times 250$  A = 189.5 A
- At 60 °C,  $I_r = (210/225) \times 250$  A = 233 A

### Additional derating coefficient for an add-on module

The values indicated in the previous tables are valid for **fixed** circuit breakers equipped with one of the following modules:

- Vigi add-on
- Vigi add-on Alarm
- ammeter module
- current-transformer module.

They also apply for **plug-in or withdrawable** circuit breakers equipped with:

- ammeter module
- current-transformer module.

However, for **plug-in or withdrawable** circuit breakers equipped with a Vigi add-on or a Vigi add-on Alarm, the coefficient 0.84 must be applied.

The table below sums up the situation for add-on modules.

Type of device	Circuit breaker	TM-D trip-unit rating	Vigi add-on or Vigi add-on Alarm	Ammeter, current transformer module, or PowerTag NSX
Fixed	NSX100	16 to 100	1	1
	NSX160 to 250	125 to 160		
	NSX250	200 to 250		
Plug-in or withdrawable	NSX100	16 to 100	0.84	
	NSX160	125 to 160		
	NSX250	200 to 250		

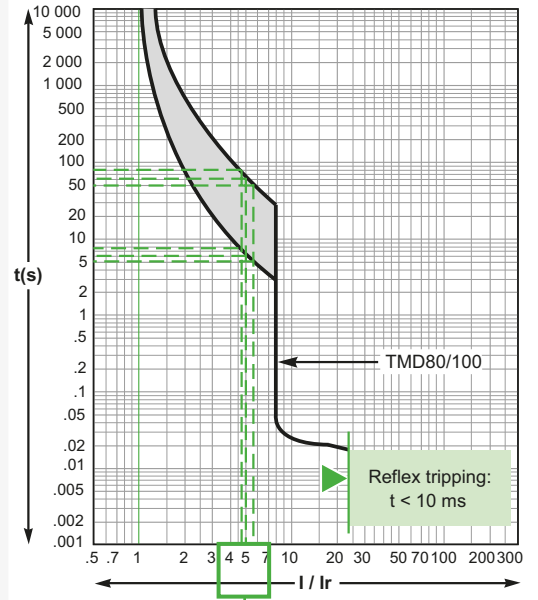

Example 1. Fault  $I = 500$  A

$I/I_r$	4.5	5	5.5
$T^{\circ}\text{C}$	20 °C	40 °C	60 °C
t min.	8 s	6 s	5 s
t max.	80 s	60 s	50 s

Thermal-protection curve with minimum and maximum values.

D9425438.eps



# ComPact NSX temperature derating

## Equipped with electronic trip units

Changes in temperature do not affect measurements by electronic trip units.

- The built-in CT sensors with Rogowski toroids measure the current.
- The control electronics compare the value of the current to the settings defined for 40 °C.

Because temperature has no effect on the toroid measurements, the tripping thresholds do not need to be modified.

However, the temperature rise caused by the flow of current and the ambient temperature increase the temperature of the device. To avoid reaching the thermal withstand level of the equipment, it is necessary to limit the current flowing through the device, i.e. the maximum Ir setting as a function of the temperature.

### ComPact NSX100/160/250

The table below indicates the maximum long-time (LT) protection setting Ir (A) depending on the ambient temperature.

Type of device	Rating (A)	Temperature (°C)						
		40	45	50	55	60	65	70
<b>NSX100/160</b>								
Fixed, plug-in	100	no derating						
or withdrawable	160	no derating						
<b>NSX250 + MicroLogic 2.2/5.2/6.2</b>								
Fixed	250	250	250	250	245	237	230	225
Plug-in or withdr.	250	250	245	237	230	225	220	215
<b>NSX250 + MicroLogic Vigi 4.2/7.2</b>								
Fixed	250	250	250	245	237	230	225	218
Plug-in or withdr.	250	225	220	215	210	205	198	190

### ComPact NSX400 and 630

The table below indicates the maximum long-time (LT) protection setting Ir (A) depending on the ambient temperature.

Type of device	Rating (A)	Temperature (°C)						
		40	45	50	55	60	65	70
<b>NSX400 + MicroLogic 2.3/5.3/6.3</b>								
Fixed	400	400	400	400	390	380	370	360
Plug-in/withdr.	400	400	390	380	370	360	350	340
<b>NSX400 + MicroLogic Vigi 4.3/7.3</b>								
Fixed	400	400	400	390	380	370	360	350
Plug-in/withdr.	400	400	390	380	370	360	350	340
<b>NSX630 + MicroLogic 2.3/5.3/6.3</b>								
Fixed	630	630	615	600	585	570	550	535
Plug-in/withdr.	630	570	550	535	520	505	490	475
<b>NSX630 + MicroLogic Vigi 4.3/7.3</b>								
Fixed	630	570	555	540	530	515	500	485
Plug-in/withdr.	630	480	470	457	445	435	420	405

Example. A fixed ComPact NSX400 equipped with a MicroLogic can have a maximum Ir setting of:

- 400 A up to 50 °C
- 380 A up to 60 °C.

# ComPact NSX temperature derating

## Equipped with electronic trip units

### Additional derating coefficient for an add-on module

For **fixed** or **plug-in / withdrawable** circuit breakers, the addition of a:

- Vigi add-on
- Vigi add-on Alarm
- ammeter module
- current-transformer module

can modify the derating values. Apply the coefficients shown below.

### Derating of a ComPact NSX equipped with a MicroLogic trip unit

Type of device	Circuit breaker	MicroLogic type	Vigi add-on or Vigi add-on Alarm	PowerTag NSX	Coupling busbar	Current transformer				
Fixed	NSX100	2.2/5.2/6.2	1	1	1	1				
		4.2/7.2	-		1					
	NSX160	2.2/5.2/6.2	1		1					
		4.2/7.2	-		1					
	NSX250	2.2/5.2/6.2	1		1					
		4.2/7.2	-		0.95					
Plug-in or withdrawable	NSX100	2.2/5.2/6.2	1		-					
		4.2/7.2	-							
	NSX160	2.2/5.2/6.2	1							
		4.2/7.2	-							
	NSX250	2.2/5.2/6.2	0.86							
		4.2/7.2	-							
Fixed	NSX400	2.3/5.3/6.3	0.97	0.97	1	1				
		4.3/7.3	-		0.97					
	NSX630	2.3/5.3/6.3	0.9		0.9		1			
		4.3/7.3	-				0.9			
	Plug-in or withdrawable	NSX400	2.3/5.3/6.3				0.97	1	-	
			4.3/7.3				-			
NSX630		2.3/5.3/6.3	0.9							
		4.3/7.3	-							

#### Note:

- Coupling busbar is forbidden with Vigi add-on.
- Current transformer is forbidden with Vigi add-on and coupling busbar.
- Coupling busbar is forbidden with withdrawable installation.
- To provide the Visu function, ComPact NSX circuit breakers, with or without a Vigi add-on, are combined with INV switch-disconnectors. Tripping values for the selected combination are indicated in the ComPact INS/INV catalog.

# ComPact NSX installation in switchboards

## Safety clearances and minimum distances

### General rules

When installing a circuit breaker, minimum distances (safety clearances) must be maintained between the device and panels, bars and other protection devices installed nearby. These distances, which depend on the ultimate breaking capacity, are defined by tests carried out in accordance with standard IEC 60947-2.

If installation conformity is not checked by type tests, it is also necessary to:

- use insulated bars for circuit-breaker connections
- segregate the busbars using insulating screens.

For ComPact NSX100 to 630 devices, terminal shields and interphase barriers are recommended and may be mandatory depending on the operating voltage of the device and type of installation (fixed, withdrawable, etc.).

### Power connections

The table below indicates the rules to be respected for ComPact NSX100 to 630 devices to ensure insulation of live parts for the various types of connection.

- fixed devices with front connection (FC) or rear connection (RC)
- plug-in or withdrawable devices.

Connection accessories such as crimp lugs, bare-cable connectors, terminal extensions (straight, right-angle, double-L and 45°) and spreaders are supplied with interphase barriers.

Long terminal shields provide a degree of protection of IP40 (ingress) and IK07 (mechanical impact).

### ComPact NSX100 to 630: rules to be respected to ensure insulation of live parts

Type of connection		Fixed, front connection			Fixed, rear connection	Plug-in or withdrawable	
						On backplate 	Through panel 
Possible, recommended or mandatory accessories:		No insulating accessory	Interphase barriers 	Long terminal shields 	Short terminal shields 	Short terminal shields 	Short terminal shields 
With:							
operating voltage	type of conductor						
< 500 V	Insulated bars 	Possible	Possible	Possible	Recommended	Recommended	Mandatory
	Extension terminals Cables + crimp lugs 	No	Mandatory (supplied)	Possible (instead of ph. barriers)	Recommended	Recommended	Mandatory
	Bare cables + connectors 	Possible for cable connectors NSX100 to 250	Possible for cable connectors NSX100 to 250	Possible for cable connectors NSX100 to 250	Recommended	Recommended	Mandatory
≥ 500 V	Insulated bars 	No	No	Mandatory (use of short terminal shield possible)	Mandatory [2]	Mandatory [2]	Mandatory [2]
	Extension terminals Cables + crimp lugs 	No	No	Mandatory	Mandatory [2]	Mandatory [2]	Mandatory [2]
	Bare cables + connectors 	No	No	Mandatory	Mandatory [2]	Mandatory [2]	Mandatory [2]

[1] Long terminal shields, mandatory if the device is fixed through the door, whatever the voltage.

[2] LV433693 (3P) or LV433694 (4P) Short Terminal Shield are mandatory for R/HB1/HB2 400 A and 630 A performance.

# ComPact NSX installation in switchboards

## Installation example

### Safety clearance

Minimum distance between two adjacent circuit breakers

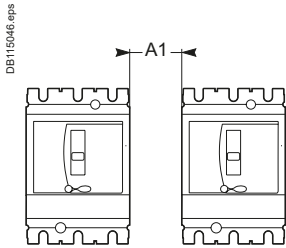

Minimum distance between circuit breaker and front or rear panels

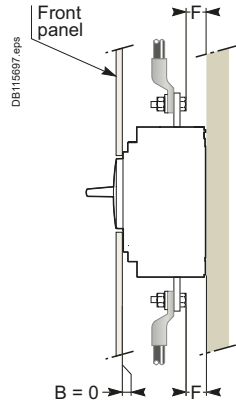

Bare or painted sheetmetal

**Note:** if  $F < 8$  mm: an insulating screen or long terminal shield is mandatory (see page C-23).

Minimum distance between circuit breaker and top, bottom or side panels

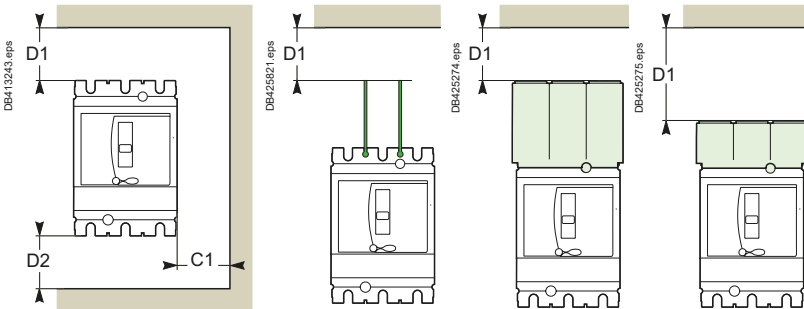

Devices without accessories.

Devices with interphase barriers or long or short terminal shields.

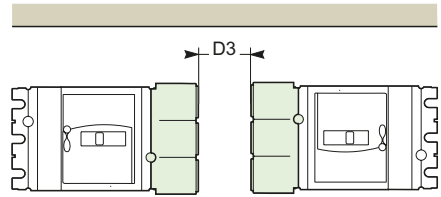

Short terminal shield rear connected.

Minimum safety clearances for ComPact NSX100 to 630

Operating voltage	Clearance (mm)							
	Between devices A1	Between device and sheetmetal						
		C1	D1	D2	C1	D1	D2	D3
<b>U ≤ 440 V</b> for devices equipped with:								
■ no accessories	0	0	30	30	5	40	40	-
■ short terminal shields	0	0	30	30	5	40	40	50
■ interphase barriers	0	0	0	0	5	0	0	-
■ long terminal shields	0	0	0	0	0	0	0	-
<b>440 V &lt; U ≤ 500 V</b> for devices equipped with:								
■ short terminal shields	0	0	30	30	10	40	40	50
■ interphase barriers <sup>[1]</sup>	0	0	0	0	20	10	10	-
■ long terminal shields <sup>[2]</sup>	0	0	0	0	10	10	10	-
<b>U &gt; 500 V</b> for devices equipped with:								
■ short terminal shields	0	10	50	50	20	100	100	50
■ long terminal shields	0	10	30	30	20	40	40	-

[1] Only for NSX100 to 250.

[2] For all cases.

### Clearances with respect to live bare busbars

Minimum clearances for ComPact NSX100 to 630

Operating voltage	Clearances with respect to live bare busbars			
	spacing ≤ 60 mm		spacing > 60 mm	
	F1	F2	F1	F2
U < 440 V	350	350	80	80
440 V ≤ U ≤ 500 V	350	350	120	120
U > 500 V	prohibited: insulating screen required between device and busbars			

These clearances can be reduced for special installations as long as the configuration is checked by tests.

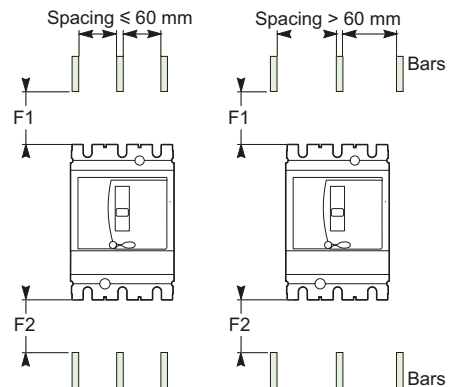

Live busbars.

# ComPact NSX

## Control wiring

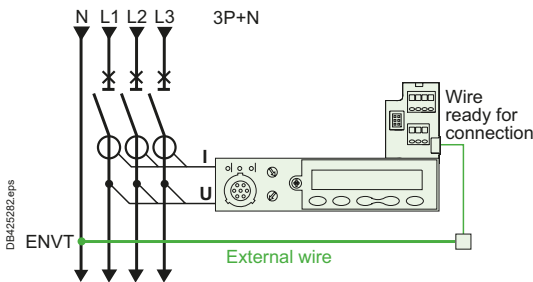

External neutral voltage tap (ENVT).

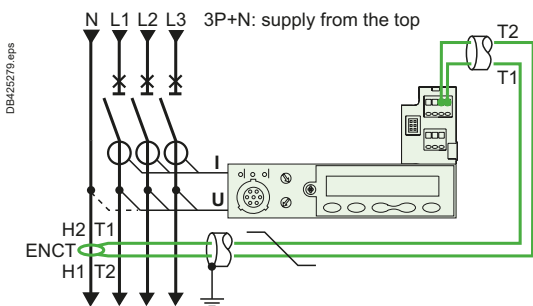

External neutral current transformer (ENCT).

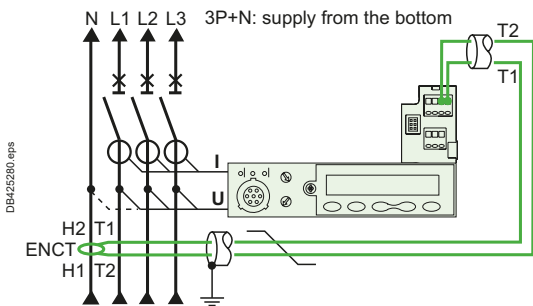

External neutral current transformer (ENCT).

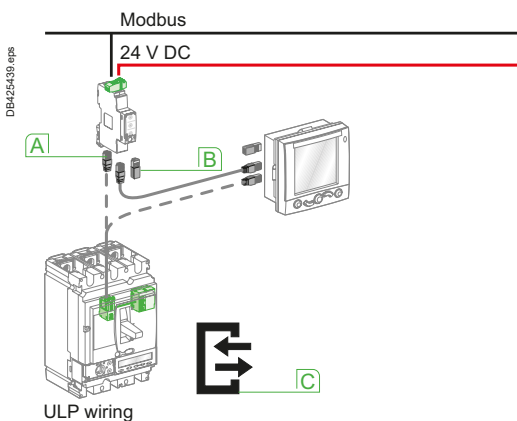

ULP connection system.

- A** RJ45
- B** Line terminator
- C** ULP symbol

### Remote tripping by MN or MX release

Power consumption is approximately:

- 30 VA for pick-up of the MN and MX releases
- 300 VA to 500 VA for the motor mechanism.

The table below indicates the maximum permissible cable length for different supply voltages and cable cross-sectional areas.

#### Recommended maximum cable lengths (in metres)

Power supply voltage (V DC)		12 V		24 V		48 V	
Cable cross-section (mm <sup>2</sup> )		1.5	2.5	1.5	2.5	1.5	2.5
MN	U source 100 %	15	–	160	–	640	–
	U source 85 %	7	–	40	–	160	–
MX	U source 100 %	60	–	240	–	960	–
	U source 85 %	30	–	120	–	480	–
Motor mechanism	U source 100 %	–	–	10	16	65	110
	U source 85 %	–	–	2	4	17	28

**Note:** the indicated length is that of each of the two wires.

### External neutral voltage tap (ENVT)

This connection is required for accurate power measurements on 3-pole circuit breakers equipped with MicroLogic 5 / 6 E trip units in installations with a distributed neutral. It can be used to measure phase-neutral voltages and calculate power using the 3 wattmeter method.

ComPact NSX 3-pole circuit breakers come with a wire installed on the device for the connection to the ENVT.

This wire is equipped with a connector for connection to an external wire with the following characteristics:

- cross-sectional area of 1 mm<sup>2</sup> to 2.5 mm<sup>2</sup>
- maximum length of 10 metres.

### External neutral current transformer (ENCT)

This connection is required to protect the neutral on 3-pole circuit breakers equipped with MicroLogic 5 / 6 A or E trip units in installations with a distributed neutral. For MicroLogic 6 A or E, it is required for type G ground-fault protection.

The ENCT is connected in the same way for fixed, plug-in or withdrawable devices:

- fixed devices are connected via terminals T1 and T2 of the internal terminal block.
- plug-in and withdrawable devices are not connected via the auxiliary terminals. The wires must be connected/disconnected inside the device via terminals T1 and T2.

The ENCT must be connected to the MicroLogic trip unit by a shielded twisted pair. The shielding should be connected to the switchboard earth only at the CT end, no more than 30 cm from the CT.

- the power connections of the CT to the neutral (H2 and H1) must be made in the same way for power supply from the top or the bottom (see figure). Make sure they are not reversed for devices with power supply from the bottom.

- cross-sectional area of 0.4 mm<sup>2</sup> to 1.5 mm<sup>2</sup>
- maximum length of 10 metres.

### ULP connection system between MicroLogic, FDM121 switchboard display and Modbus interface

The ULP (Universal Logic Plug) wiring system used by ComPact NSX for connections through to the Modbus network requires neither tools nor settings. The prefabricated cords are used for both data transfer and distribution of 24 V DC power. Connectors on each component are identified by ULP (Universal Logic Plug) symbols, ensuring total compatibility between each component.

#### Available cords

All connections are made with prefabricated cords:

- NSX cord for connection of the internal terminal block to the Modbus interface or the FDM121 display via an RJ45 connector. The cord is available in three lengths, 0.35 m, 1.3 m and 3 m
- ULP cords with RJ45 connectors at each end for the other connections between components. The cord is available in six lengths, 0.3 m, 0.6 m, 1 m, 2 m, 3 m and 5 m. For greater distances, two cords can be interconnected using the RJ45 female/female accessory.

Maximum length of 10 m between 2 modules and 30 m in all.

A line terminator must be fitted to all components with an unused RJ45 connector.



## External 24 V DC power-supply module (AD)

The external power-supply module makes it possible:

- to use the display even if the circuit breaker is open or not supplied (for the exact conditions of use, see the “electrical diagrams” part of this catalog)
- to display fault currents after tripping
- to modify settings when the circuit breaker is open (OFF position)

An external 24 V DC power supply is required for installation with communication, whatever the type of trip unit.

This module is not designed to power on 24 V DC voltage releases and electric motor mechanism.

This module powers both the control unit and the M2C programmable contacts. We recommended using the AD power supply due to its low stray primary secondary capacitance. Good operation of the MicroLogic control unit in noisy environment is not guaranteed with other power supplies.

If the COM option is used, a second dedicated power supply shall be used.

This module powers both the control unit and the M2C programmable contacts or ESM module.

### Characteristics

- Power supply AC-to-DC or DC-to-DC
- Output voltage: 24 V DC  $\pm 5\%$
- Output current: 1 A.
- DIN rail or platine Fixing with Acti9 form factor
- Conducted emissions power line: class B per EN/IEC 61000-6-3.

## Wiring (see page E-89)

### MicroLogic 5 / 6 / 7 not using the Communication function

The external 24 V DC supply is connected via the circuit breaker terminal block. Use of a 24 V DC battery provides backup power for approximate 3 hours (100 mA) in the event of an interruption in the external supply.

### MicroLogic 5 / 6 / 7 using the Communication function

The external 24 V DC supply is connected via the Modbus interface using a five-pin connector, including two for the power supply. Stacking accessories (see page D-2) can be used to supply a number of interfaces by fast clip-on connection. The 24 V DC power is distributed downstream by the ULP (Universal Logic Plug) communication cords with RJ45 connectors. This system ensures both data transfer and power distribution to the connected modules.

### Recommendations for 24 V DC wiring

- Do not connect the positive terminal to earth.
- Do not connect the negative terminal to earth.
- The maximum length for each conductor (+/-) is ten metres.
- For connection distances greater than ten metres, the plus and minus conductors of the 24 V DC supply must be twisted to improve EMC.
- The 24 V DC conductors must cross the power cables perpendicularly. If this is difficult or impossible, the plus and minus conductors must be twisted.

## Modbus (see page E-89)

Each ComPact NSX circuit breaker equipped with MicroLogic 5 / 6 / 7 and an FDM121 display is connected to the Modbus network via the Modbus interface module.

Connection of all the circuit breakers and other Modbus devices in the switchboard to a Modbus bus is made much easier by using a Modbus RJ45 junction block installed in the switchboard.

### Recommendations for Modbus wiring

- The shielding may be earthed.
- The conductors must be twisted to improve immunity (EMC).
- The Modbus conductors must cross the power cables perpendicularly.

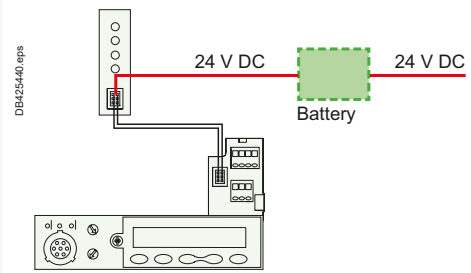

Power supply, without the Communication function, via the terminal block with a backup battery.

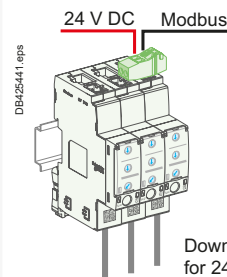

Supply, with the Communication function, via the Modbus interface.



External 24 V DC power supply module (AD)





ABL8 RPS power supply.

PF106348SE\_ABL8RPS24050.eps

### 24 V DC Universal Phaseo™ ABL8 power supplies

The Universal Phaseo ABL8 RPS 24050 and ABL8 RPS 24030 power supplies can be connected phaseto-neutral or phase-to-phase.

They deliver a voltage that is precise to 3%, whatever the load and whatever the value of the AC

supply, within the ranges 85 to 132 V AC and 170 to 550 V AC.

The Universal Phaseo ABL8 powers:

- circuit breaker communication module and interface
- programmable MicroLogic.

#### Characteristics

- Power supply AC-to-DC,
- Network frequency: 50/60 Hz (±5 %).
- Output voltage: 24 V DC ±3%.
- Output current: 3 or 5 A
- DIN rail or platine Fixing
- Conducted emissions power line: class B per EN/IEC 61000-6-3.

To assist cooling there must be sufficient clearance around the Universal range Phaseo power supplies:

- 50 mm above and below
- 10 mm on the side.

		ABL8RPS●●●●	Module AD
Over Voltage Category		Cat I per VDE 0106-1	Cat IV per IEC 62477-1 (AC model) Cat III per IEC 62477-1 (DC model) Cat III per UL 61010-1
Degree of pollution as per IEC 60664-1		2	3
Input supply voltage AC		100...120 V AC and 200...500 V AC	110-130 or 200-240 V AC
Input supply voltage DC		N/A	24-30 or 48-60 or 100-125 V DC
Dielectric	Input/Output	4 kV rms -1 mn.	3 kV rms - 1 mn. (110-130 V AC and 200-240 V AC model) 3 kV rms - 1 mn. (110-125 V DC model) 2 kV rms - 1 mn. (24-30 V DC and 48-60 V DC model)
	Input/Ground	3.5 kV rms -1 mn.	3 kV rms - 1 mn.
	Output /Ground	0,5 kV rms - 1 mn.	1.5 kV rms - 1 mn.
Temperature		<ul style="list-style-type: none"> <li>■ 50 °C</li> <li>■ 60 °C with 80 % of the rated current maximum</li> </ul>	70°C
Output current		3 A (ABL8RPS24030) 5 A (ABL8RPS24050)	1 A
Inrush current for 2 ms		< 30 A	< 20 A
Ripple		200 mV peak-peak	200 mV peak-peak
Output voltage limits		24 to 28.8 V DC	22.8 to 25.2 V DC
Protection degree		IP20	IP4x front face / IP2x terminals / IP3x other

**Note:** For the applications requiring an over voltage category higher than 2, a surge arrester shall be associated to ABL8 RPS power supplies. The iQuick20pr type 2 surge arrester is recommended.

# ComPact NSX power loss/ resistance

## Equipped with thermal-magnetic trip units

ComPact NSX thermal power loss values are used to calculate total temperature rise in the switchboard in which the circuit breakers are installed.

The values indicated in the tables below are typical values for a device at full rated load and 50/60 Hz.

### Power loss per pole (P/pole) in Watts (W)

The value indicated is the power loss at  $I_N$ , 50/60 Hz, for a three-pole or four-pole circuit breaker. Measurement and calculation of power loss are carried out in compliance with the recommendations of Annex G of standard IEC 60947-2.

### Resistance per pole (R/pole) in milliohms (mΩ)

The value of the resistance per pole is provided as a general indication for a new device.

The value of the contact resistance must be determined on the basis of the measured voltage drop, in accordance with the manufacturer's test procedure (ABT instruction document no. 1 - BEE - 02.2 -A).

**Note:** this measurement is not sufficient to determine the quality of the contacts, i.e. the capacity of the circuit breaker to carry its rated current.

### Additional power loss

Additional power loss is equal to the sum of the power dissipated by the following:

- **Vigi add-on:** note that the deviation of the N and L3 bars required to pass through the toroid results in higher power losses compared to those of the L1 and L2 bars (diagram opposite). When calculating total power loss, use L1, L2, L3 for a 3P device and N, L1, L2, L3 for a 4P device
- disconnecting contacts (plug-in and withdrawable devices)
- ammeter module
- transformer module.

### Calculation of total power loss

Total power loss at full rated load and 50/60 Hz is equal to the sum of the device and additional power losses per pole multiplied by the number of poles (2, 3 or 4).

If a Vigi is installed, it is necessary to differentiate between N and L3 on one hand and L1 and L2 on the other.

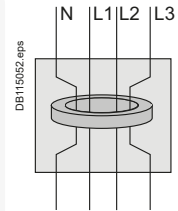

With a Vigi add-on, the deviation of the N and L3 bars required to pass through the toroid results in higher power losses compared to those of the L1 and L2 bars.

### ComPact NSX100 to 250 equipped with TM-D and TM-G trip units

Type of device	Fixed device			Additional power / pole						
	3/4 poles	Rat. (A)	R/pole	P/pole	Vigi add-on (N, L3)	Vigi add-on (L1, L2)	Plug-in / withdr.	Ammeter module	Transfo. module	PowerTag NSX module
NSX100	16	11.42	2.92	0	0	0	0	0	0	0
	25	6.42	4.01	0	0	0.1	0	0	0	0
	32	3.94	4.03	0.06	0.03	0.15	0.1	0.1	0.1	0
	40	3.42	5.47	0.10	0.05	0.2	0.1	0.1	0.1	0
	50	1.64	4.11	0.15	0.08	0.3	0.1	0.1	0.1	0.1
	63	2.17	8.61	0.3	0.15	0.4	0.1	0.1	0.1	0.1
	80	1.37	8.77	0.4	0.2	0.6	0.1	0.1	0.1	0.1
	100	0.88	8.8	0.7	0.35	1	0.2	0.2	0.2	0.2
NSX160	80	1.26	8.06	0.4	0.2	0.6	0.1	0.1	0.1	0.1
	100	0.77	7.7	0.7	0.35	1	0.2	0.2	0.2	0.2
	125	0.69	10.78	1.1	0.55	1.6	0.3	0.3	0.3	0.3
	160	0.55	13.95	1.8	0.9	2.6	0.5	0.5	0.5	0.5
NSX250	125	0.61	9.45	1.1	0.55	1.6	0.3	0.3	0.3	0.3
	160	0.46	11.78	1.8	0.9	2.6	0.5	0.5	0.5	0.5
	200	0.39	15.4	2.8	1.4	4	0.8	0.8	0.8	0.8
	250	0.3	18.75	4.4	2.2	6.3	1.3	1.3	1.3	1.3

### ComPact NSX100 to 630 equipped with MA/1.3-M trip units

Type of device	Fixed device			Additional power / pole						
	3 poles	Rat. (A)	R/pole	P/pole	Vigi add-on (N, L3)	Vigi add-on (L1, L2)	Plug-in / withdr.	Ammeter module	Transfo. module	PowerTag NSX module
NSX100	2.5	148.42	0.93	0	0	0	0	0	0	0
	6.3	99.02	3.93	0	0	0	0	0	0	0
	12.5	4.05	0.63	0	0	0	0	0	0	0
	25	1.66	1.04	0	0	0.1	0	0	0	0
	50	0.67	1.66	0.2	0.1	0.3	0.1	0.1	0.1	0.1
	100	0.52	5.2	0.7	0.35	1	0.2	0.2	0.2	0.2
NSX160	150	0.38	8.55	1.35	0.68	2.6	0.45	0.45	0.45	0.5
NSX250	220	0.3	14.52	2.9	1.45	4.89	0.97	0.97	0.97	1
NSX400	320	0.12	12.29	3.2	1.6	6.14	1.54	1.54	1.54	1.43
NSX630	500	0.1	25	13.99	7	15	3.75	3.75	3.75	3.5



# ComPact NSX power loss/ resistance

## Equipped with electronic trip units

The values indicated in the table below are typical values for a device at full rated load and 50/60 Hz. The definitions and information are the same as that for circuit breakers equipped with thermal-magnetic trip units.

### ComPact NSX100 to 630 equipped with MicroLogic trip units

Type of device		Fixed device		Additional power (W)/ pole		Plug-In	Transfo Module	PowerTag NSX module		
3/4 poles	Rating (A)	R/pole (mΩ)	P/Pole (w)	Vigi add-on (N/L3)	Vigi add-on (L1/L2)					
<b>NSX + MicroLogic 2.2/5.2/6.2</b>										
NSX100	<40 A	0.84	1.3	0.1	0.06	0.2	0.1	0		
	40 A ≤ 100 A	0.47	4.7	0.7	0.35	1	0.2	0.2		
NSX160	<40 A	0.73	1.2	0.4	0.2	0.6	0.1	0		
	40 A ≤ 160 A	0.36	9.2	1.8	0.9	2.6	0.5	0.5		
NSX250	<40 A	0.27	2.7	1.1	0.55	1.6	0.2	0		
	40 A ≤ 250 A	0.28	17.6	4.4	2.2	6.3	1.3	1.3		
<b>NSX + MicroLogic 2.3/5.3/6.3</b>										
NSX400	<400 A	0.12	19.2	3.2	1.6	9.6	2.4	2.24		
NSX630	<630 A	0.1	39.7	6.5	3.25	19.49	5.95	5.56		
<b>NSX + MicroLogic add-on 4.2/7.2</b>		<b>N/L1/L3</b>	<b>L2</b>	<b>N/L1/L3</b>	<b>L2</b>					
NSX100	<100 A	0.58	0.49	5.8	4.9	-	-	1	0.2	
NSX160	<160 A	0.48	0.39	12.3	10.0	-	-	2.6	0.5	
NSX250	<250 A	0.4	0.33	25	20.6	-	-	6.3	1.3	
<b>NSX + MicroLogic add-on 4.3/7.3</b>										
NSX400	<400 A	0.16	0.14	25.6	22.4	-	-	9.6	2.4	2.24
NSX630 <sup>[1]</sup>	<630 A	0.14	0.12	55.6	47.6	-	-	19.49	5.95	5.56

Power loss/resistance values presented above are not contractual.

[1] The power loss values for Vigi add-on and withdrawable circuit breakers are given for 570 A.

# ComPact NSXm dimensions and mounting

## Circuit breaker and switch-disconnector

### Circuit breaker

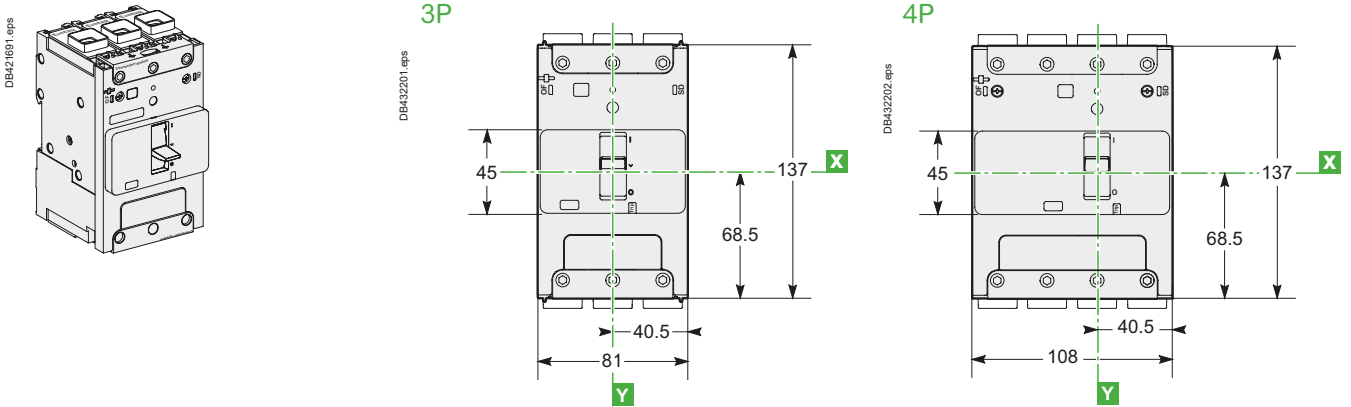

### Circuit breaker with MicroLogic Vigi 4.1

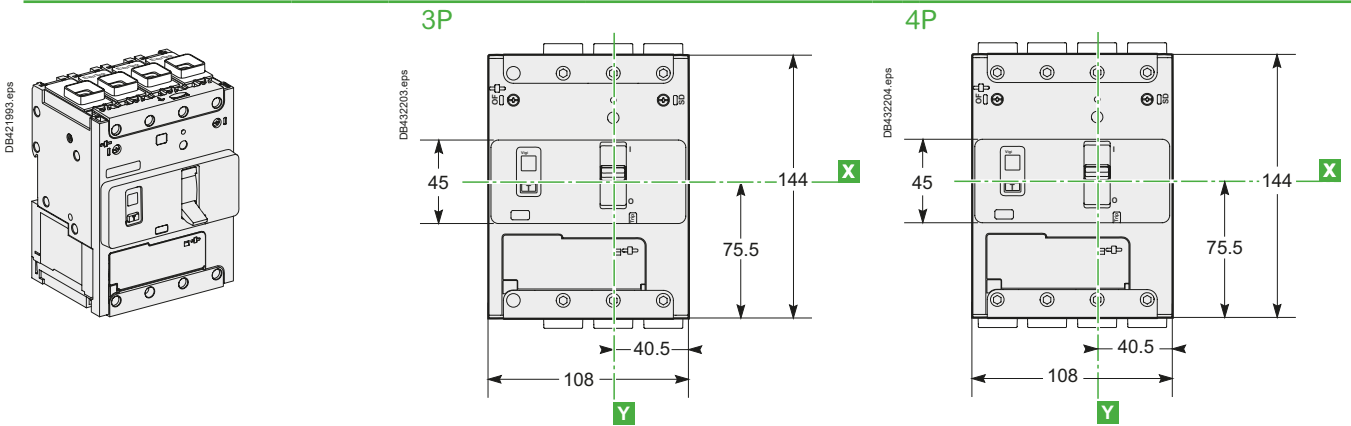

### Side view

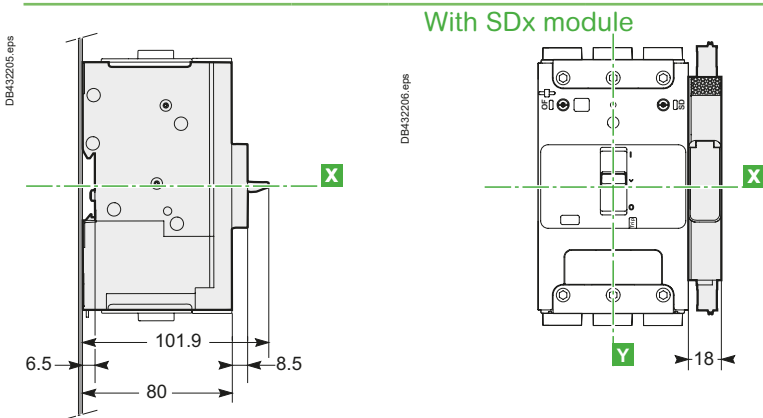

### Front-panel cutouts

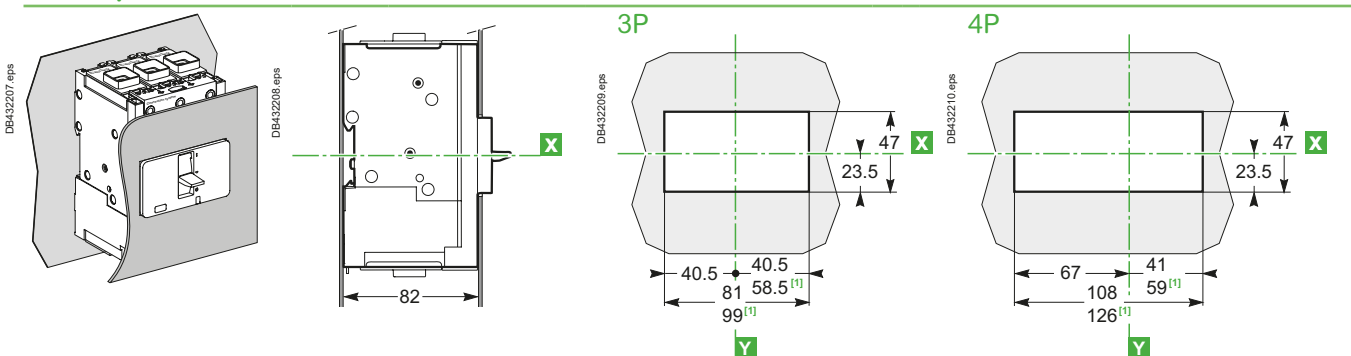

[1] With SDx module.



# ComPact NSXm dimensions and mounting

## Circuit breaker and switch-disconnector

### Connectors

#### EverLink with control wire terminal connector

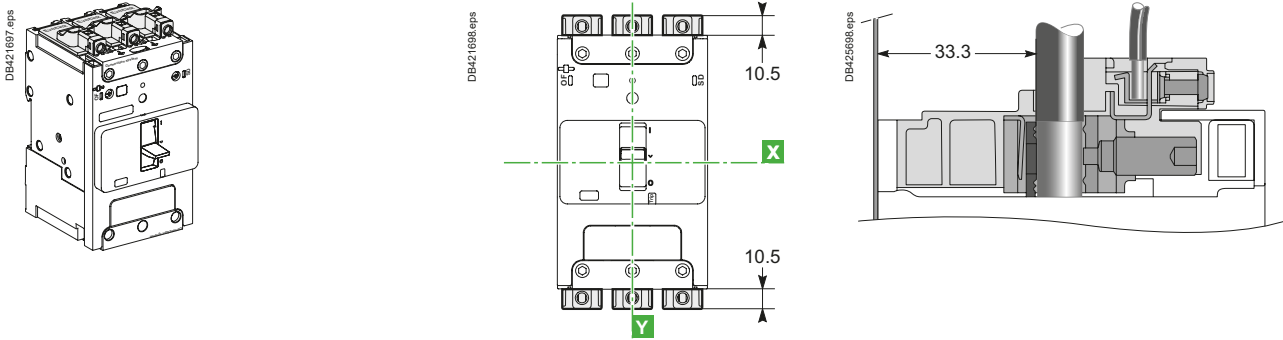

#### EverLink without control wire terminal connector

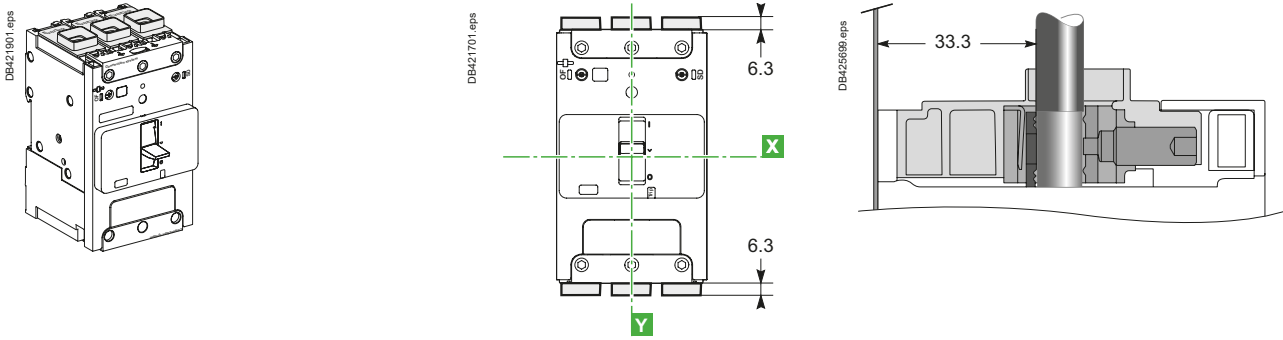

#### Mechanical lug connector

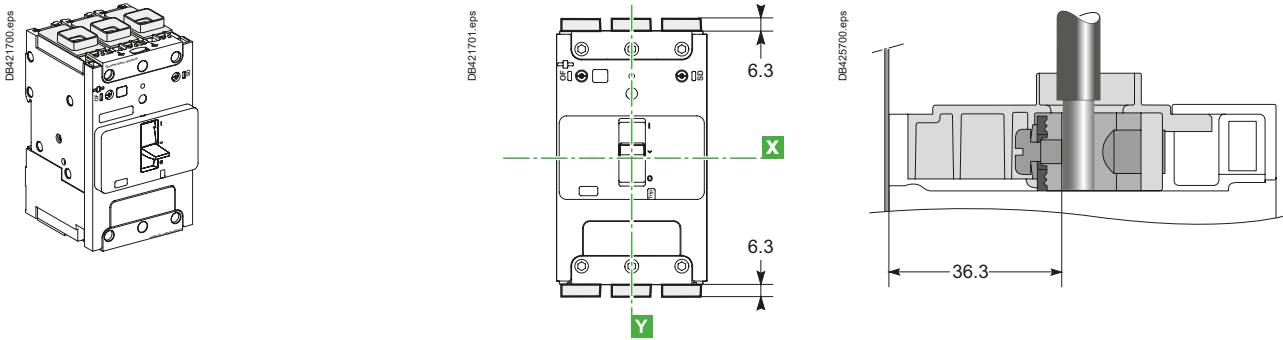

#### Compression lug / busbar connector

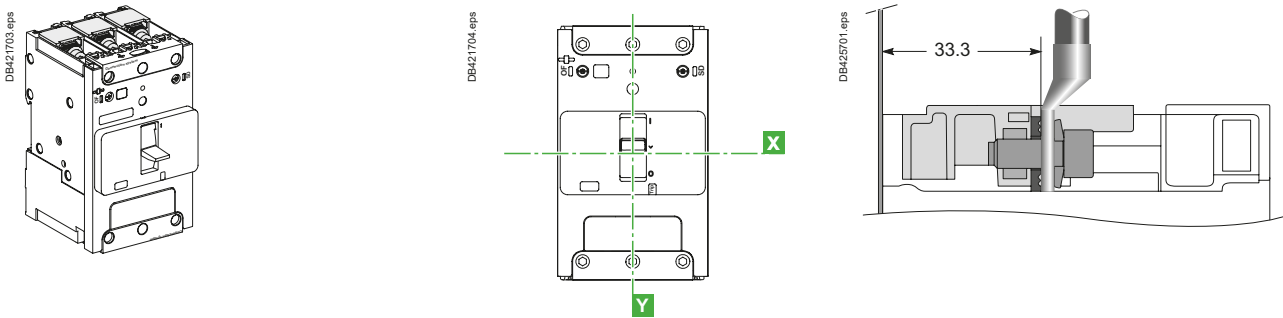

E

# ComPact NSXm dimensions and mounting

## Circuit breaker and switch-disconnector

### Insulation of live parts

#### Long terminal shields

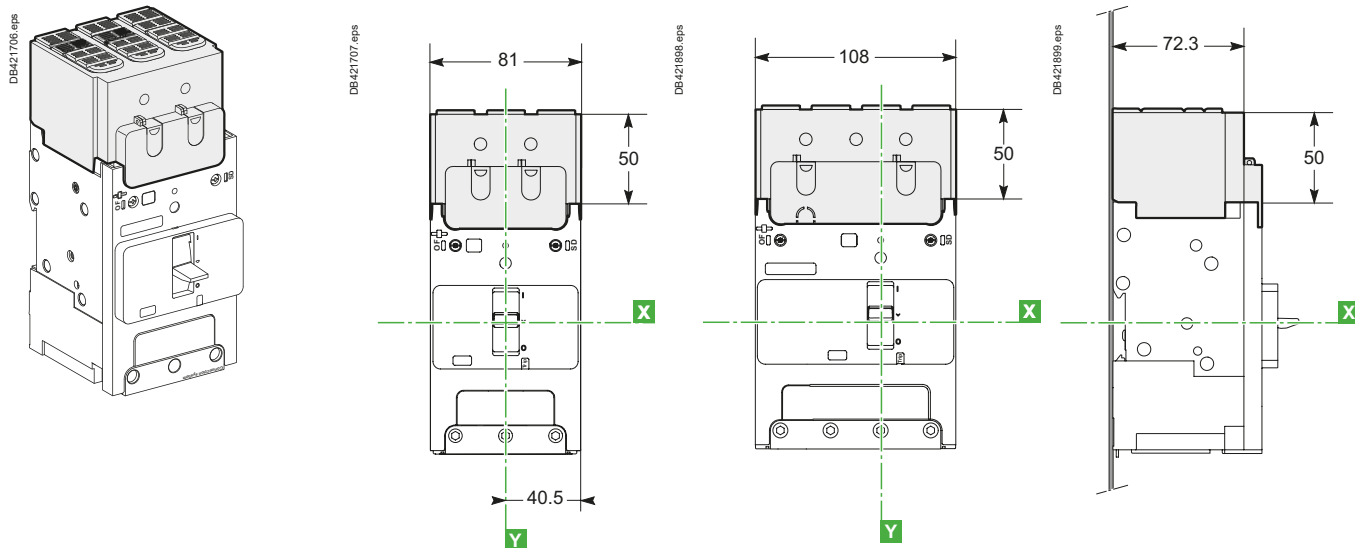

#### Interphase barriers

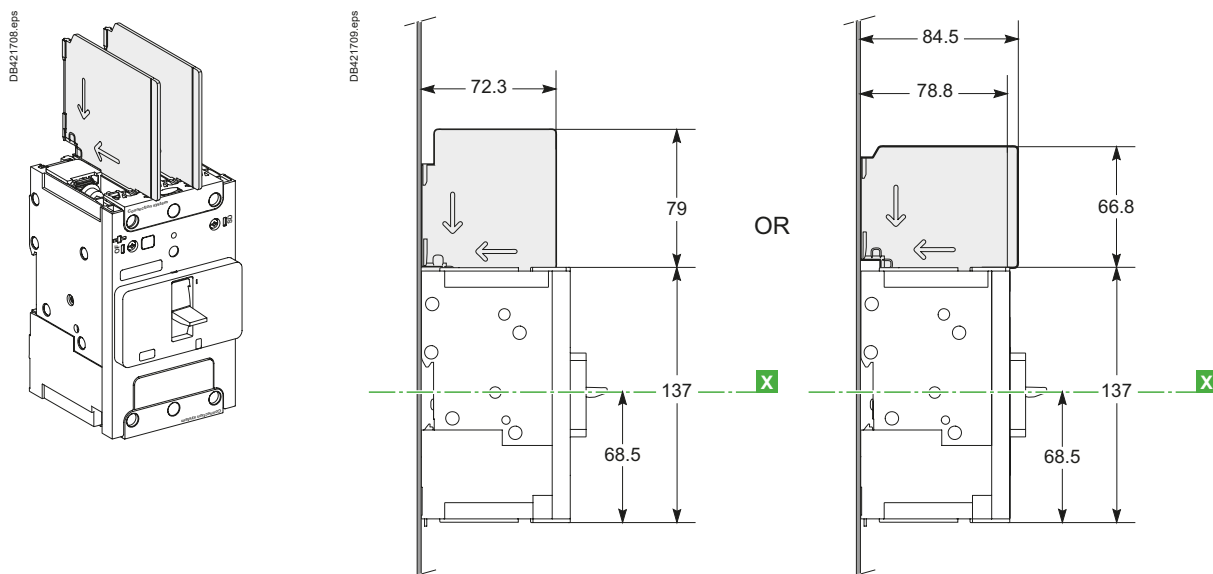

# ComPact NSXm dimensions and mounting

## Circuit breaker and switch-disconnector

### Rear insulating screens

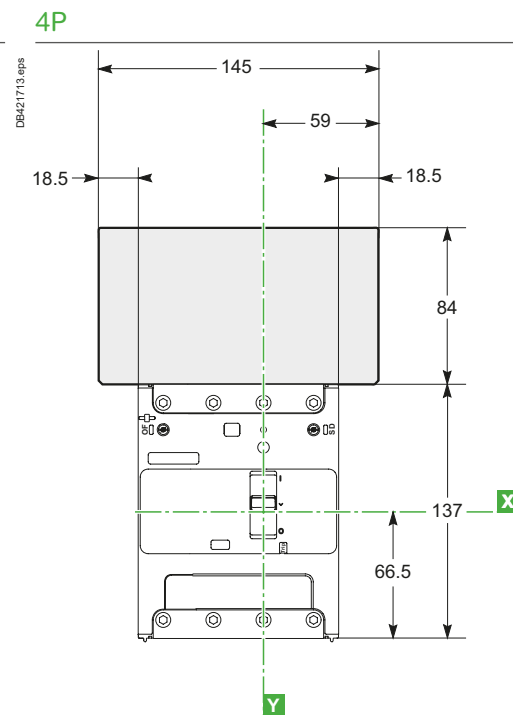
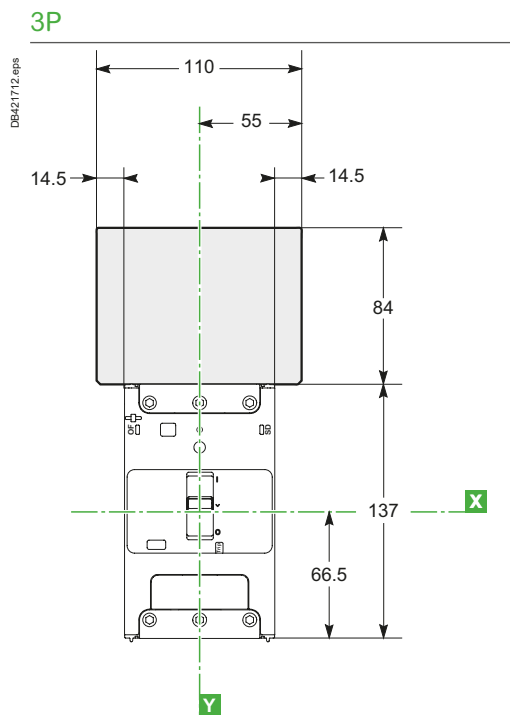
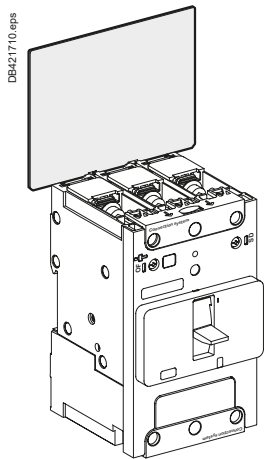



# ComPact NSXm dimensions and mounting

## Circuit breaker and switch-disconnector

### Mounting on backplate

3P/4P

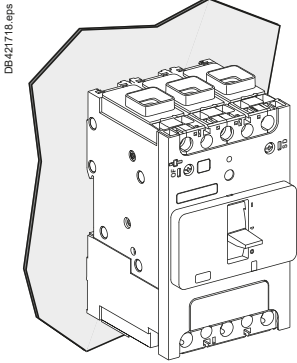

3P

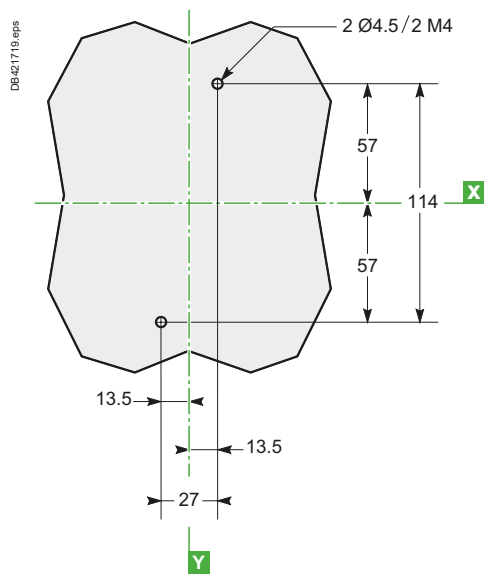

4P

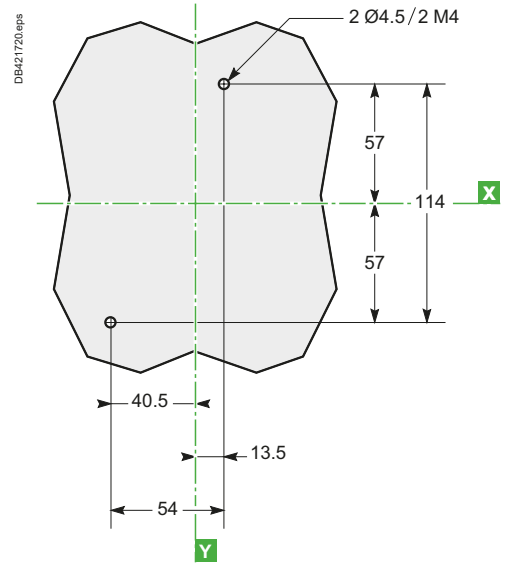

### 3P/4P Circuit breaker with MicroLogic Vigi 4.1

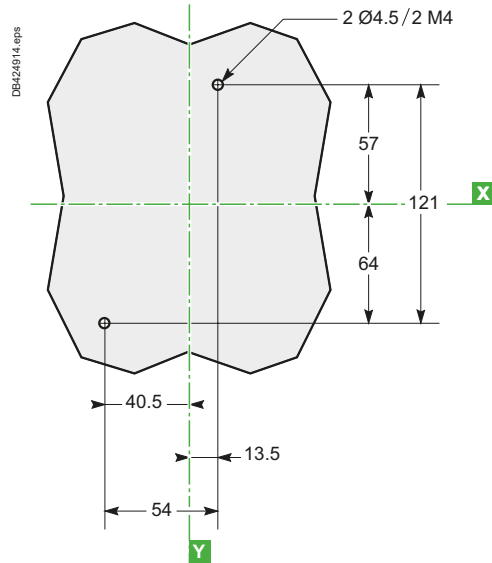

### Mounting on DIN rail

3P

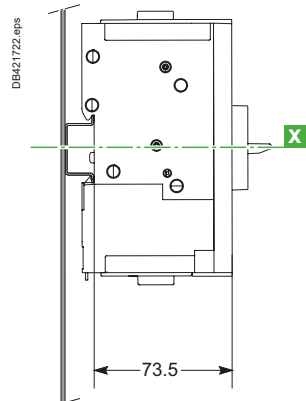
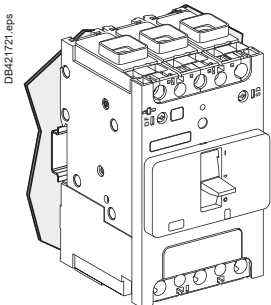

# ComPact NSXm dimensions and mounting

## Circuit breaker and switch-disconnector

### Direct rotary handle

3P

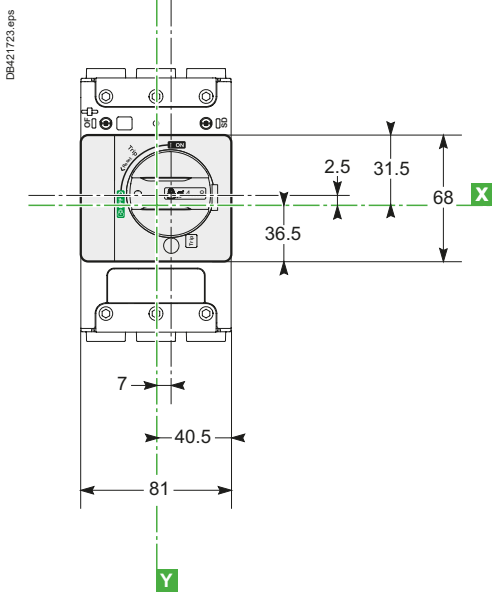

4P

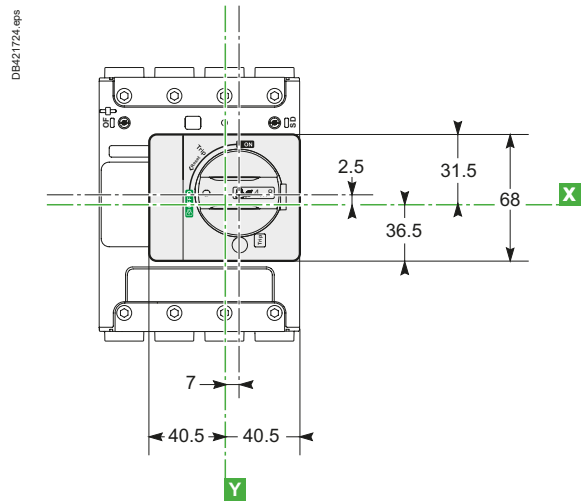

### Side view

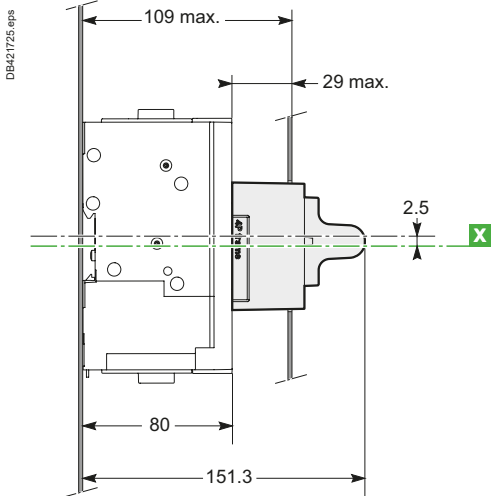

### Door cutout for 3P/4P

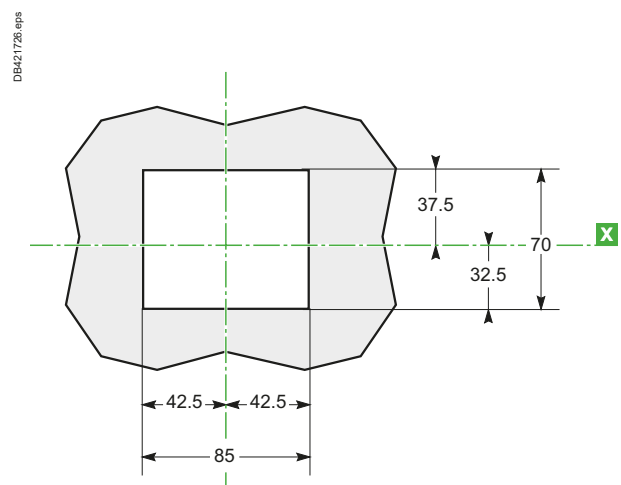

E

# ComPact NSXm dimensions and mounting

## Circuit breaker and switch-disconnector

### Extended rotary handle

3P

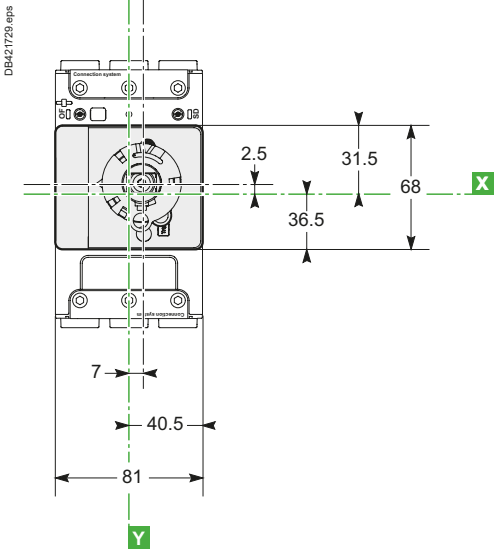

4P

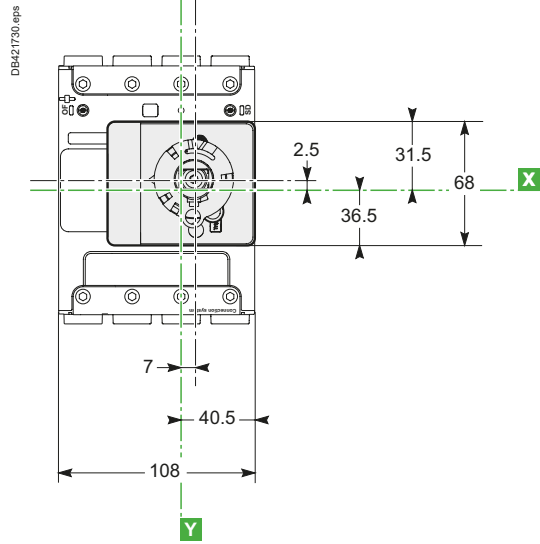

3P/4P

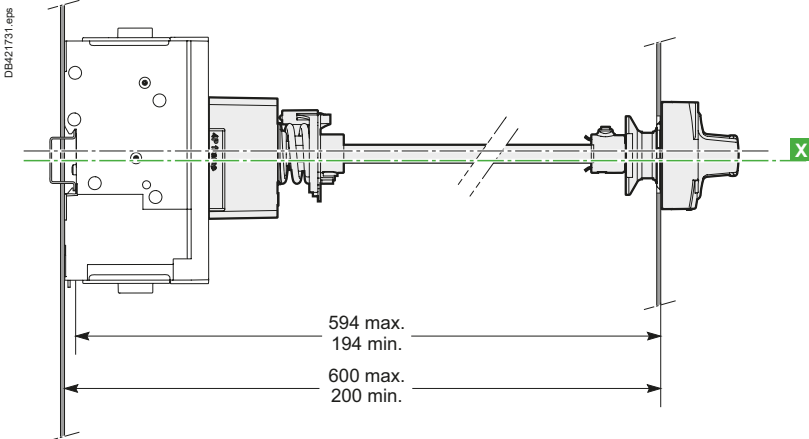

### Dimensions and front-panel cutout

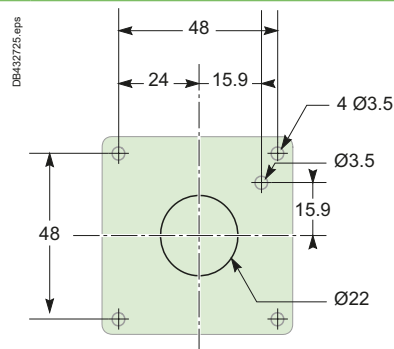
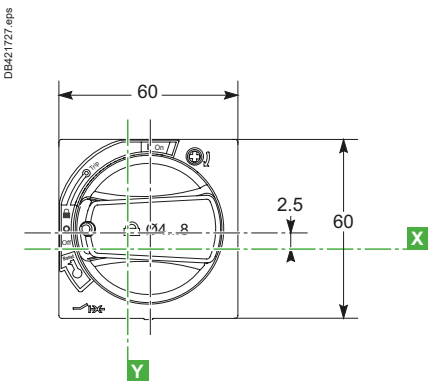

# ComPact NSXm dimensions and mounting

## Circuit breaker and switch-disconnector

### Side rotary handle

#### 3P - Extended

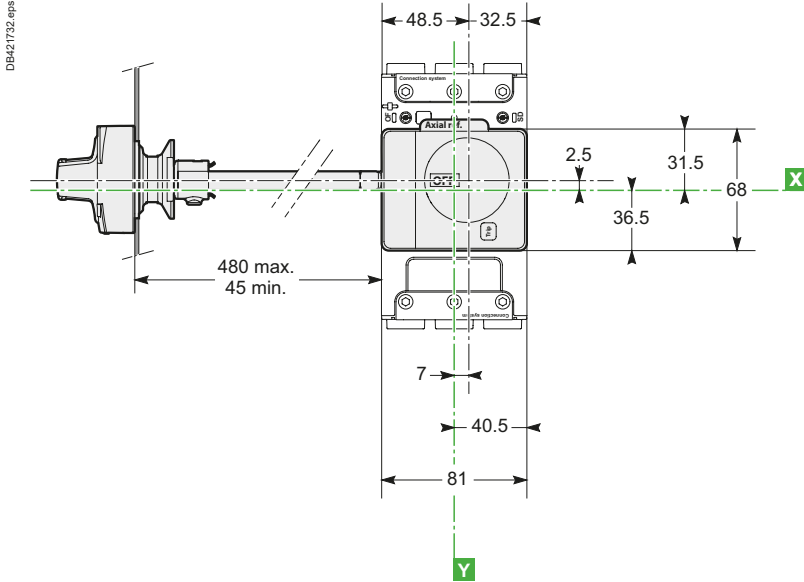

#### 4P - Extended

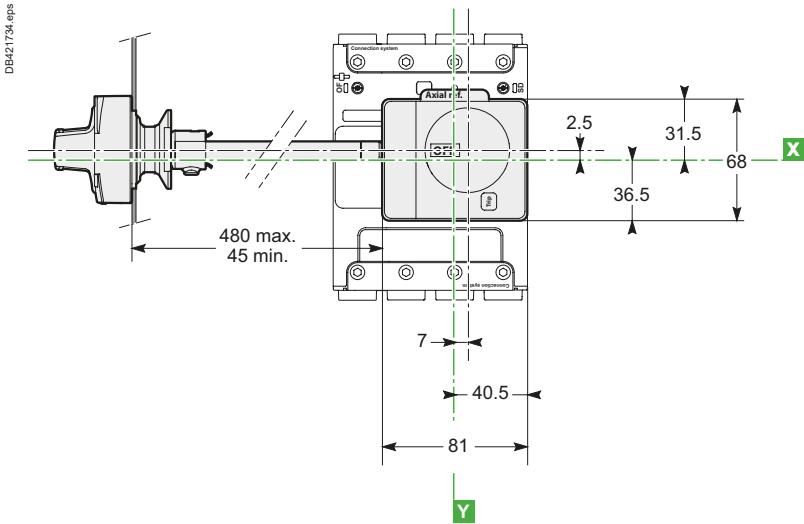

#### 4P - Direct

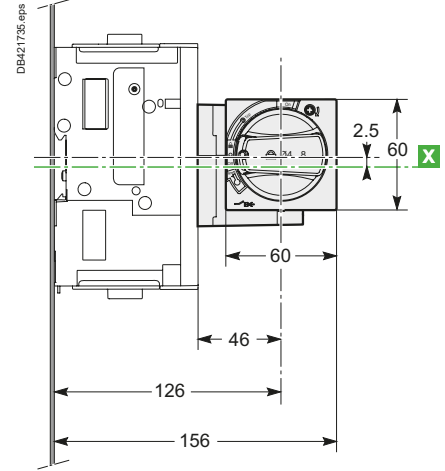

### Dimensions side rotary handle cutout

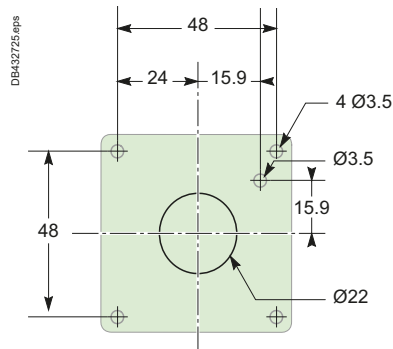
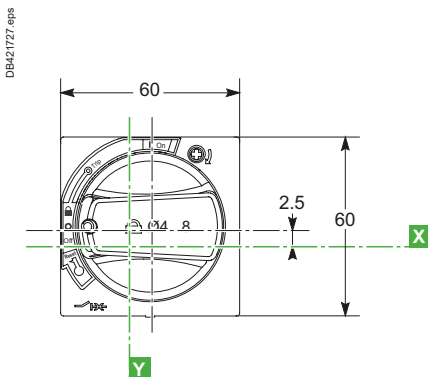

# ComPact NSXm dimensions and mounting

## Circuit breaker and switch-disconnector

### Connection with accessories

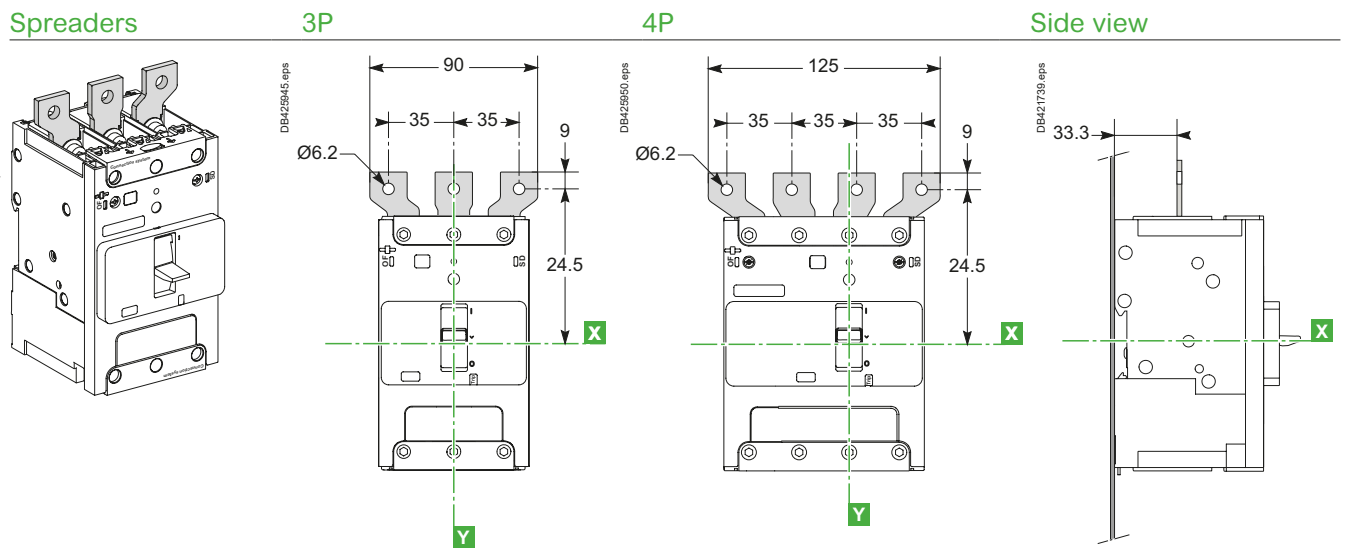

# ComPact NSX dimensions and mounting

## ComPact NSX100 to NSX250 fixed version, 1P-2P

### Dimensions

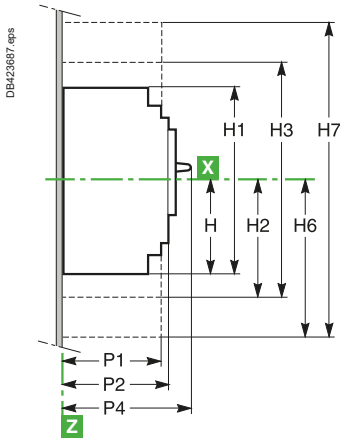

1 pole

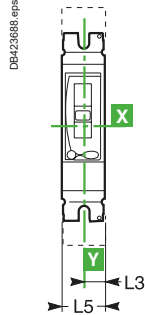

2 poles

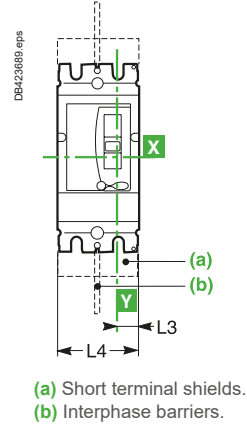

### Mounting

#### On backplate

1 pole

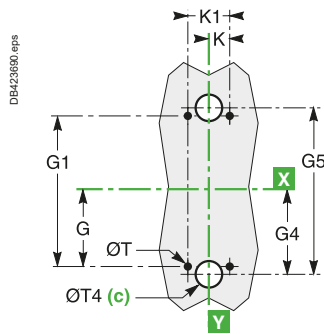

(c) For rear connection only.

2 poles

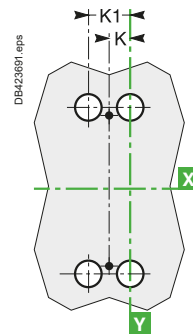

E

#### On rails

1 pole

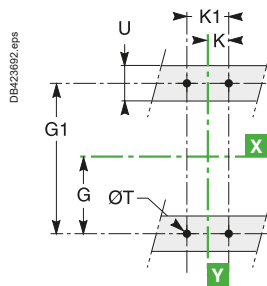

2 poles

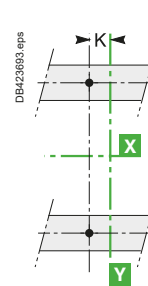

# ComPact NSX dimensions and mounting

## ComPact NSX100 to NSX250 fixed version, 1P-2P

### Front-panel cutout

On backplate

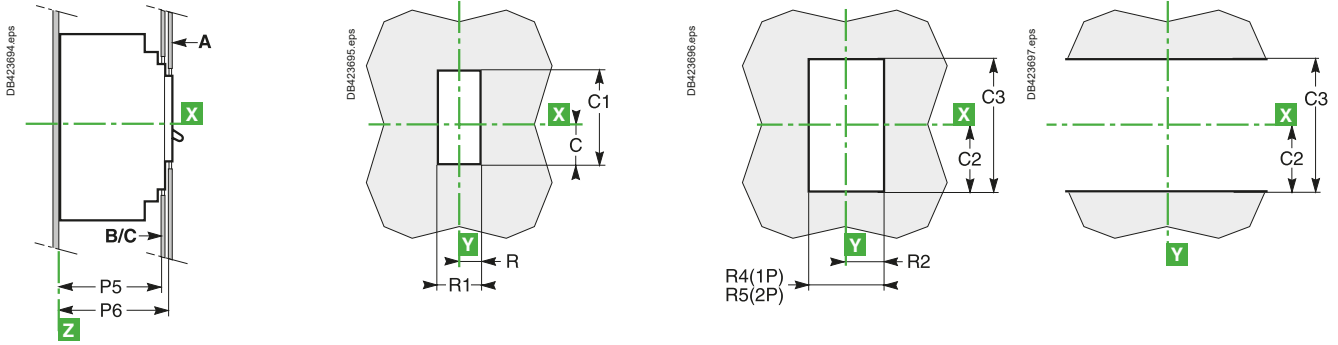

### With escutcheon

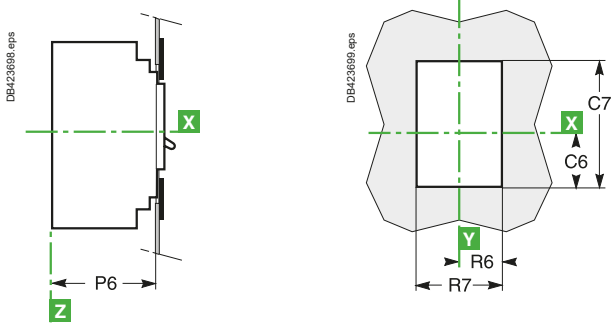

#### Dimensions (mm)

Type	C	C1	C2	C3	C6	C7	G	G1	G4	G5	H
NSX100/250	29	76	54	108	43	104	62.5	125	70	140	80.5
Type	H1	H2	H3	H4	H6	H7	K	K1	L3	L4	L5
NSX100/250	161	94	188	160.5	178.5	357	17.5	35	17.5	70	35
Type	P1	P2	P4	P5	P6	R	R1	R2	R4	R5	R6
NSX100/250	81	86	111	83	88	14.5	29	19	38	73	29
Type	R7	ØT	ØT4	U							
NSX100/250	58	6	22	≤ 32							



# ComPact NSX dimensions and mounting

## ComPact NSX100 to 630 fixed version

### Dimensions

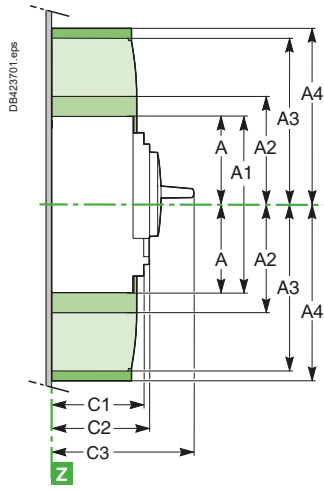
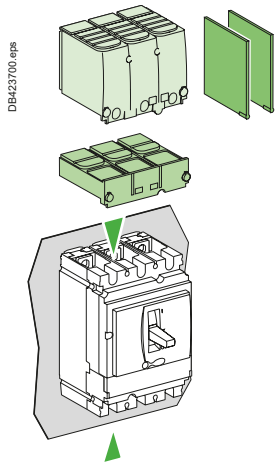

### 2/3P

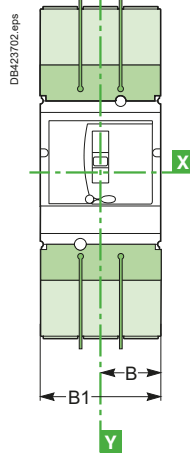

### 4P

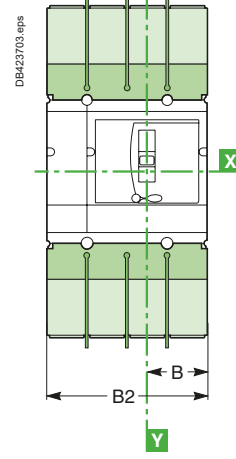

Interphase barriers.
  Long terminal shields (also available for NSX400/630 spreaders with 52.5 mm pitch:
  Short terminal shields.

B1 = 157.5 mm, B2 = 210 mm).

### Mounting

#### NSX100 to 250

#### NSX400/630 [2]

#### NSX100 to 630 [2]

#### On backplate

#### 2/3P

#### 3P

#### 4P

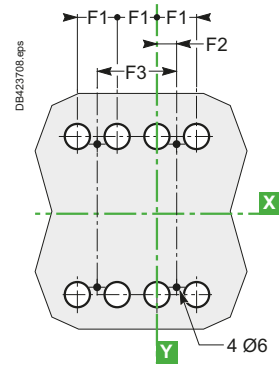
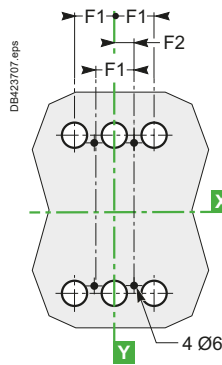
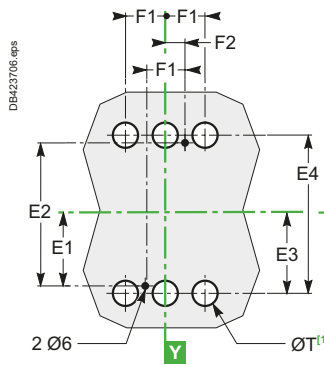
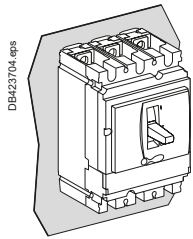

[2] For 630 A only:

[1] The ØT holes are required for rear connection only. For two-pole circuit breakers, the middle holes are not required.

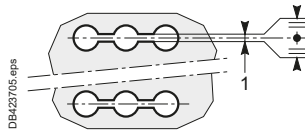

#### On rails

#### 2/3P

#### 3P

#### 4P

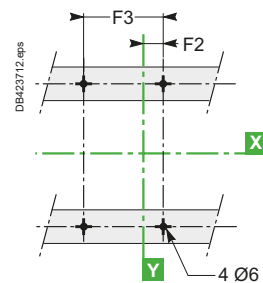
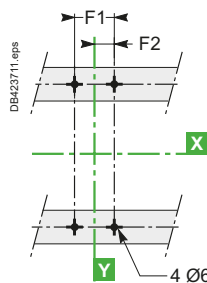
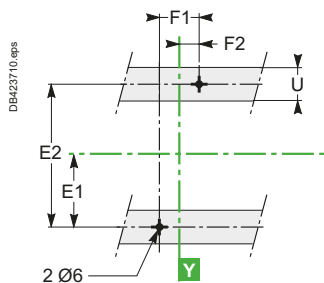
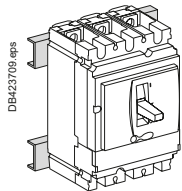

#### On DIN rail with adapter plate (NSX100 to 250)

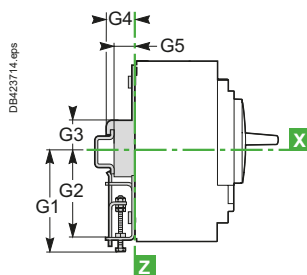
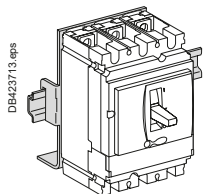



# ComPact NSX dimensions and mounting

## ComPact NSX100 to 630 Vigi add-on fixed version

### Dimensions

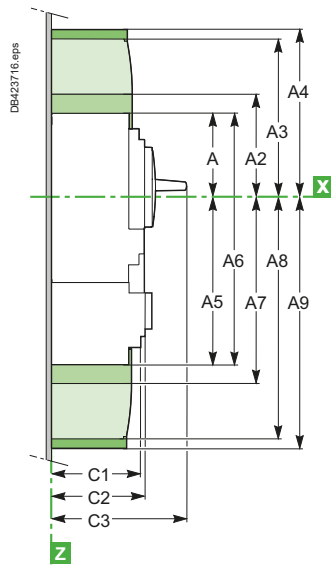
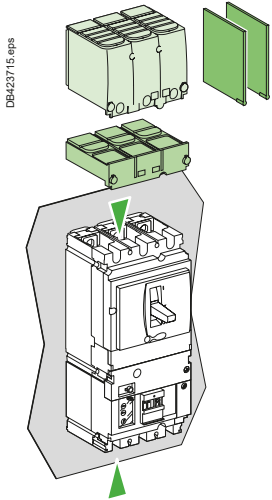

### 3/4P NSX100 to 250

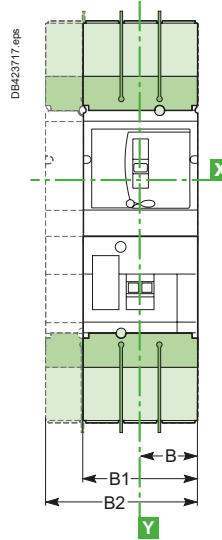

### 3/4P NSX400/630

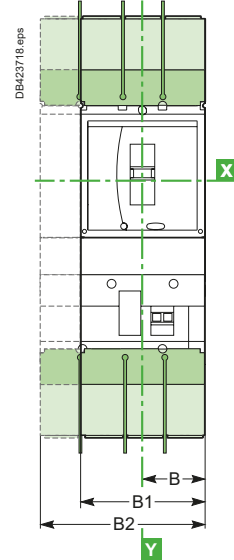

### Mounting

On backplate

### NSX100 to 250

3P

### NSX400/630 [2]

3P

### NSX100 to 630 [2]

4P

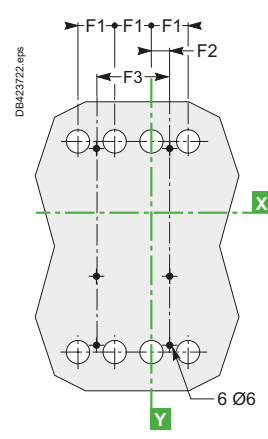
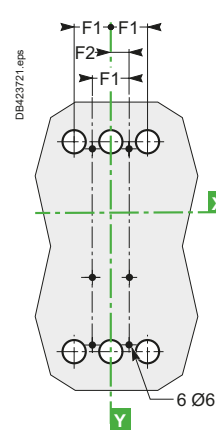
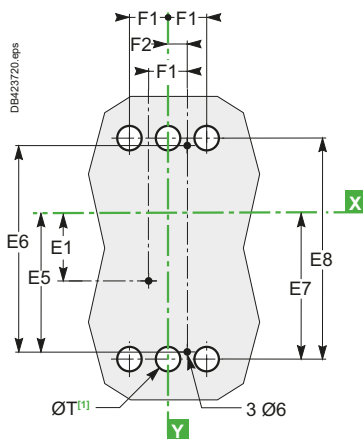
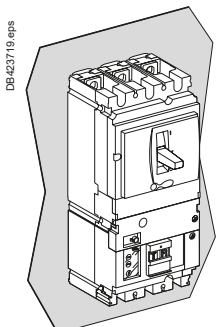

[2] For 630 A only:

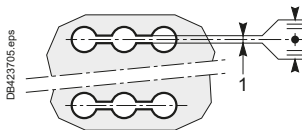

[1] The ØT holes are required for rear connection only.  
For two-pole circuit breakers, the middle holes are not required.

### On rails

3P

3P

4P

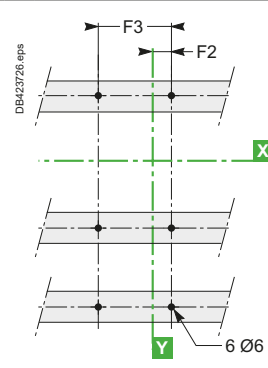
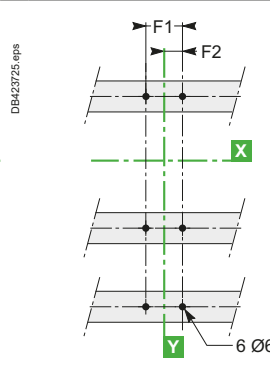
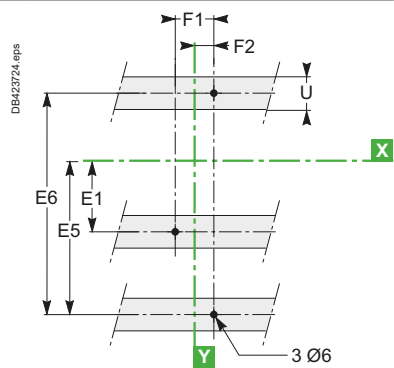
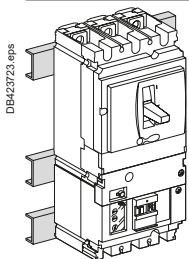

Type	A	A1	A2	A3	A4	A5	A6	A7	A8	A9	B	B1	B2	C1	C2	C3	E1
NSX100/160/250	80.5	161	94	145	178.5	155.5	236	169	220	253.5	52.5	105	140	81	86	126	62.5
NSX400/630	127.5	255	142.5	200	237	227.5	355	242.5	300	337	70	140	185	105	110	168	100
Type	E2	E3	E4	E5	E6	E7	E8	F1	F2	F3	G1	G2	G3	G4	G5	ØT	U
NSX100/160/250	125	70	140	137.5	200	145	215	35	17.5	70	95	75	13.5	23	17.5	24	≤ 32
NSX400/630	200	113.5	227	200	300	213.5	327	45	22.5	90	-	-	-	-	-	32	≤ 35

# ComPact NSX dimensions and mounting

## ComPact NSX100 to 630 plug-in version

### Dimensions

#### 2/3P

#### 4P

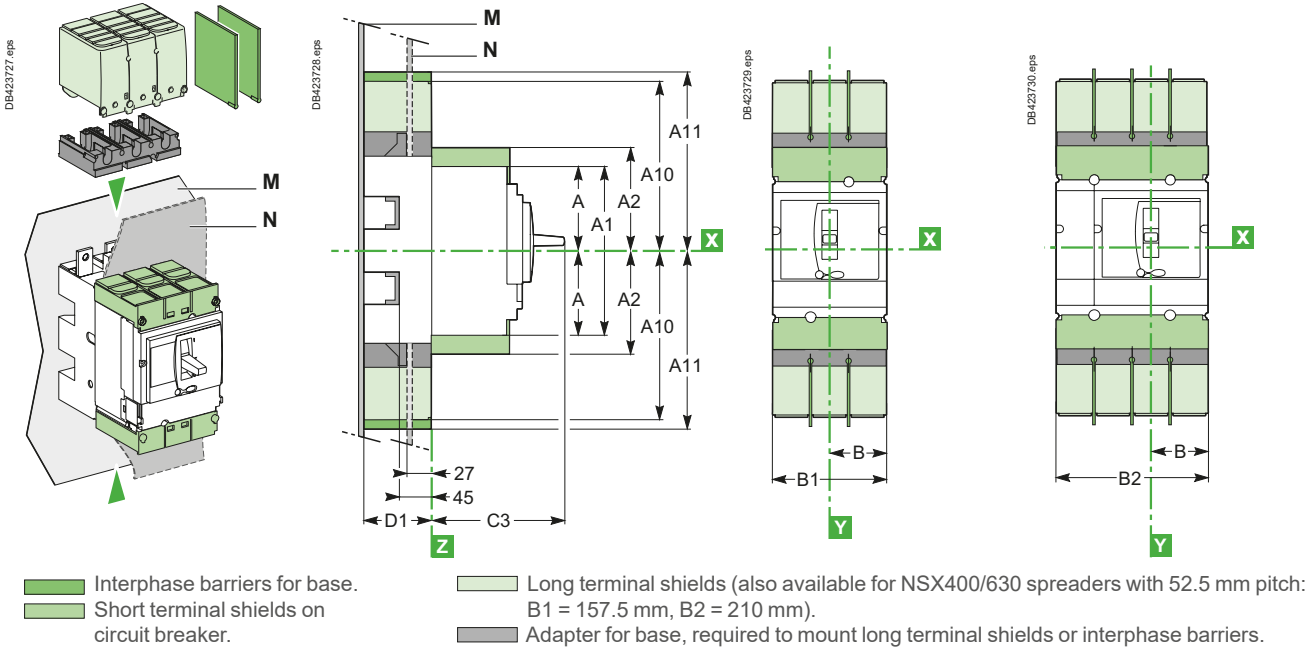

### Mounting

#### Through front panel (N)

#### 2/3P

#### 3P

#### 4P

#### NSX400/630

#### NSX100 to 630

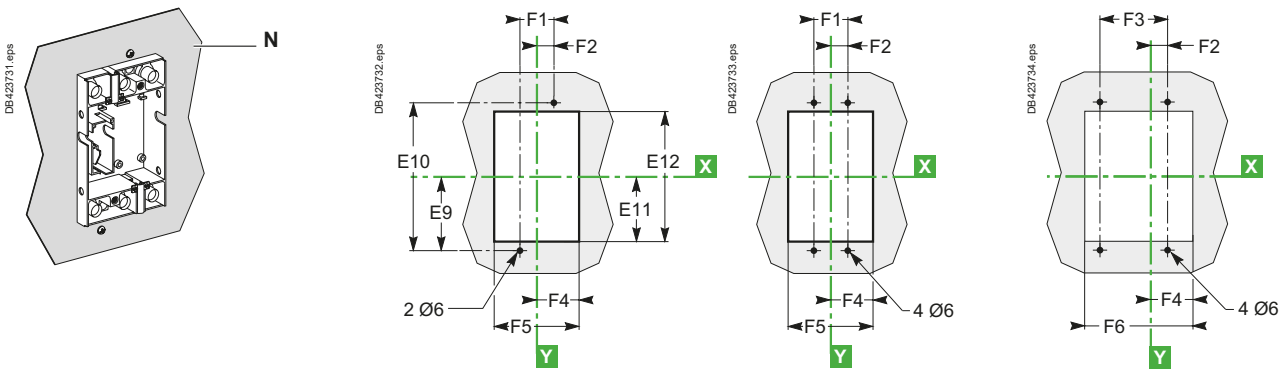

# ComPact NSX dimensions and mounting

## ComPact NSX100 to 630 plug-in version

### On backplate (M)

Front connection (an insulating screen is supplied with the base and must be fitted between the base and the backplate)

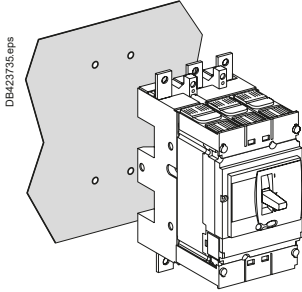

### 2/3P

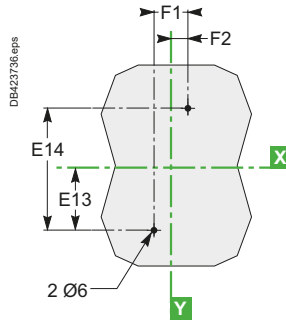

### 4P

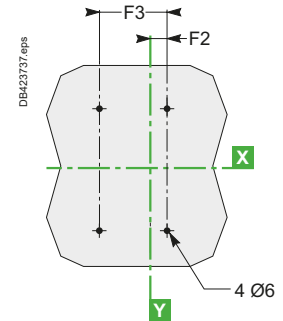

### Connection by exterior-mounted rear connectors

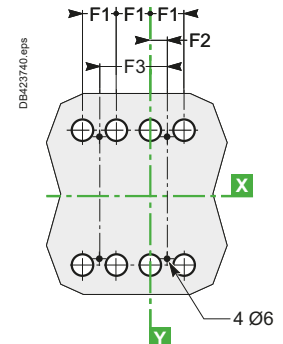
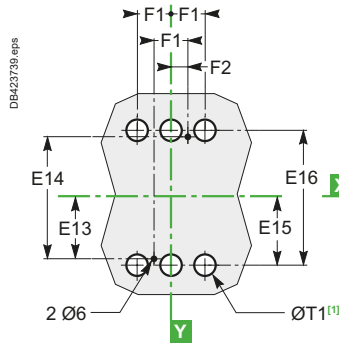
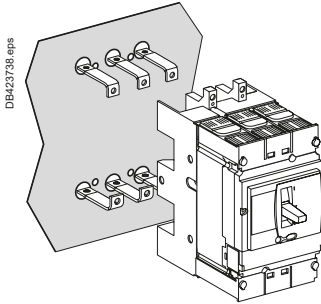

[1] The ØT1 holes are required for rear connection only (for two-pole circuit breakers, the middle holes are not required).

### Connection by interior-mounted rear connectors

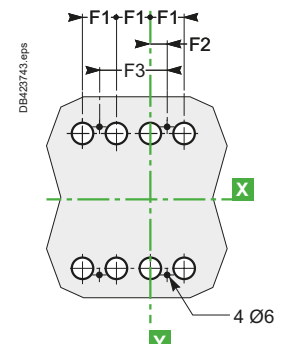
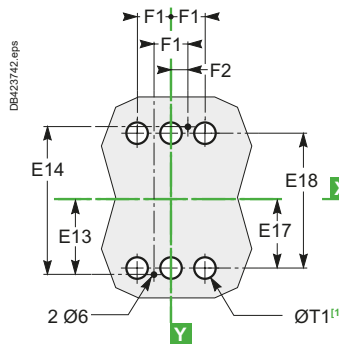
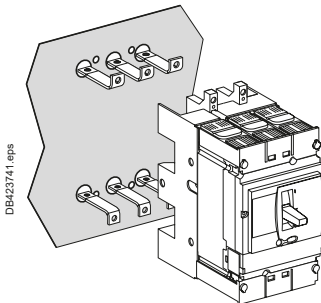

[1] The ØT1 holes are required for rear connection only (for two-pole circuit breakers, the middle holes are not required).

### On rails

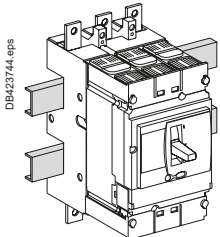

### 2/3P

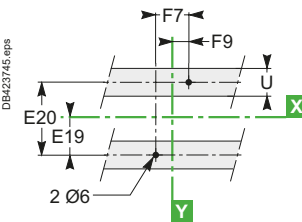

### 4P

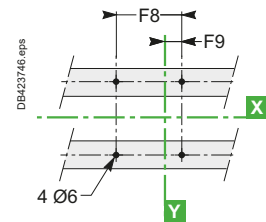

Type	A	A1	A2	A10	A11	B	B1	B2	C3	D1	E9	E10	E11	E12	E13	E14	E15
NSX100/160/250	80.5	161	94	175	210	52.5	105	140	126	75	95	190	87	174	77.5	155	79
NSX400/630	127.5	255	142.5	244	281	70	140	185	168	100	150	300	137	274	125	250	126
Type	E16	E17	E18	E19	E20	F1	F2	F3	F4	F5	F6	F7	F8	F9	ØT1	U	
NSX100/160/250	158	61	122	37.5	75	35	17.5	70	54.5	109	144	70	105	35	24	≤ 32	
NSX400/630	252	101	202	75	150	45	22.5	90	71.5	143	188	100	145	50	33	≤ 35	



# ComPact NSX dimensions and mounting

## ComPact NSX100 to 630 withdrawable version

### Dimensions

### 2/3P

### 4P

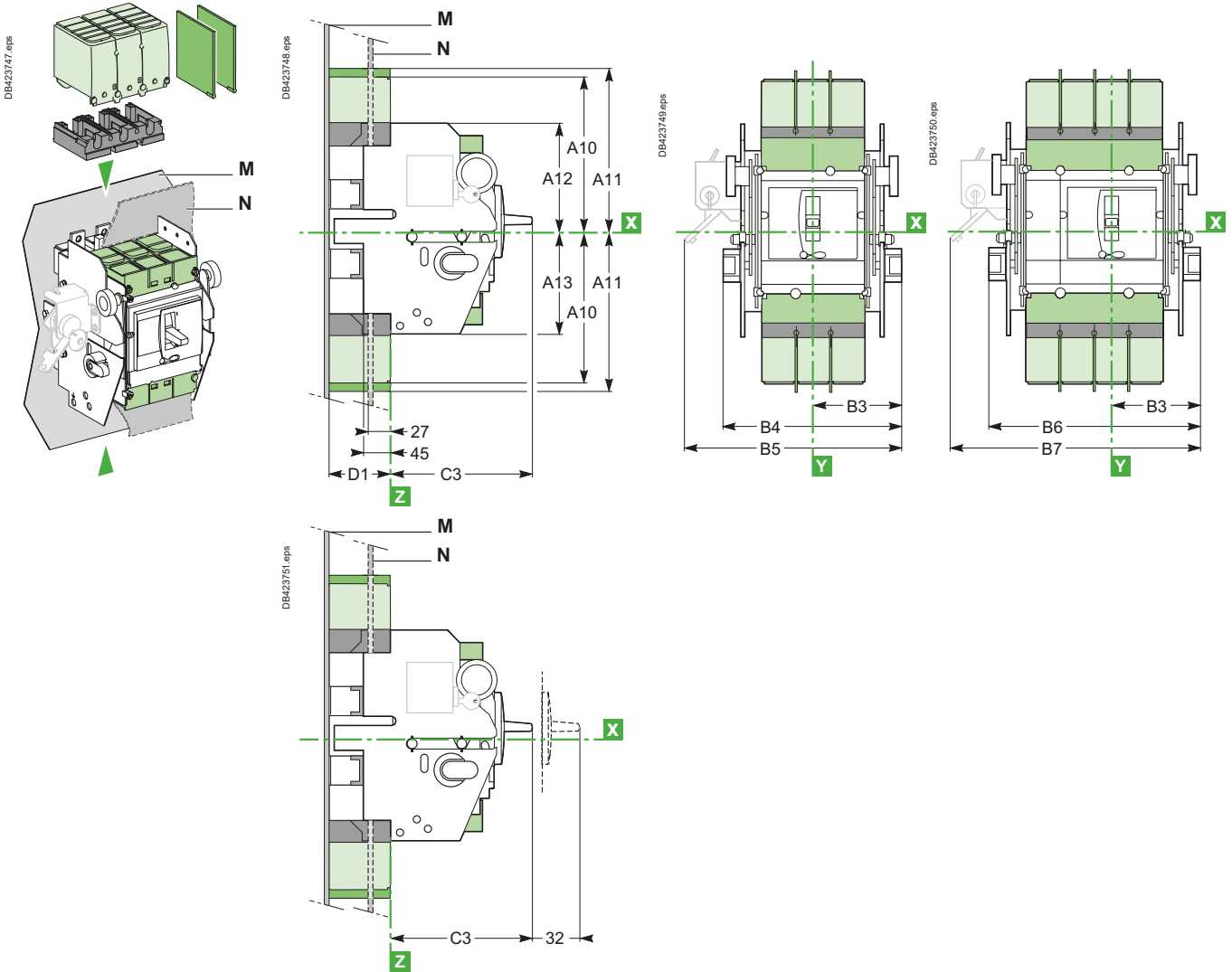

- Interphase barriers for base.
- Short terminal shields on circuit breaker.
- Long terminal shields.
- Adapter for base, required to mount long terminal shields or interphase barriers.

### Mounting

#### Through front panel (N)

#### 2/3P

#### 3P

#### 4P

NSX100 to 250

NSX400/630

NSX100 to 630

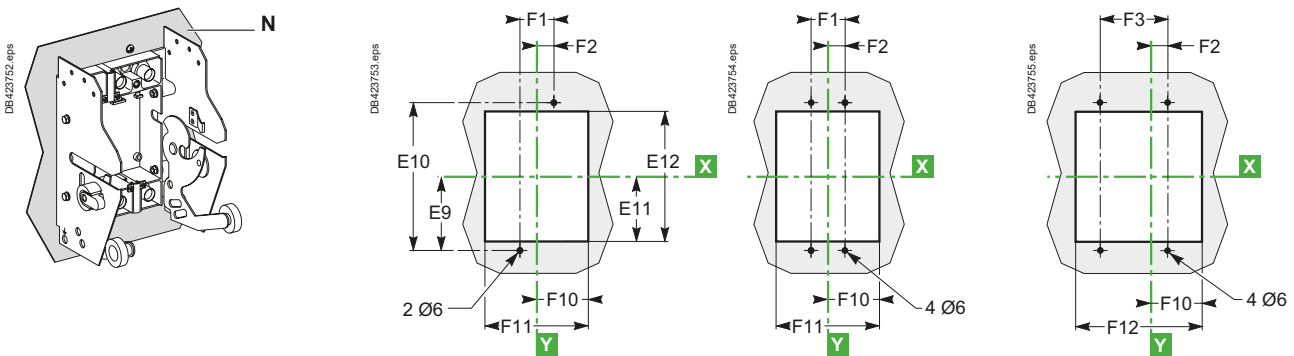

# ComPact NSX dimensions and mounting

## ComPact NSX100 to 630 withdrawable version

### On backplate (M)

#### 2/3P

#### 4P

Front connection (an insulating screen is supplied with the base and must be fitted between the base and the backplate)

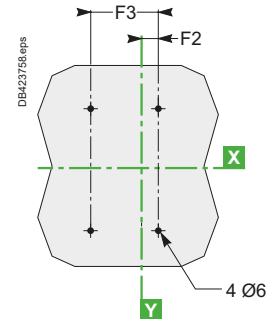
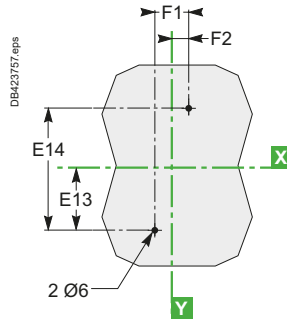
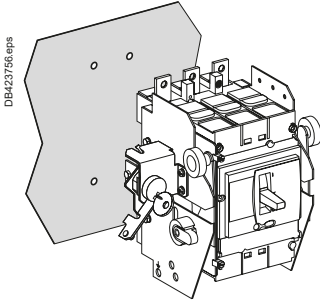

### Connection by exterior-mounted rear connectors

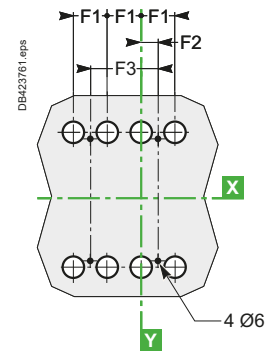
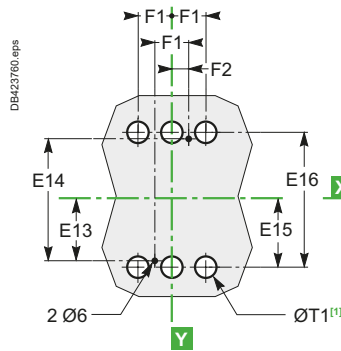
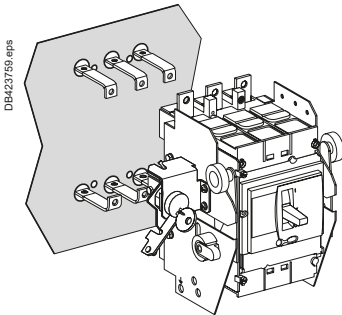

[1] The ØT1 holes are required for rear connection only (for two-pole circuit breakers, the middle holes are not required).

### Connection by interior-mounted rear connectors

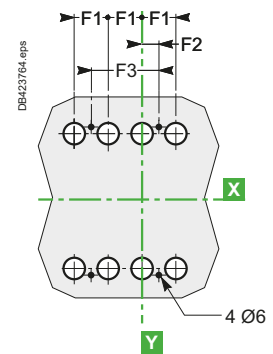
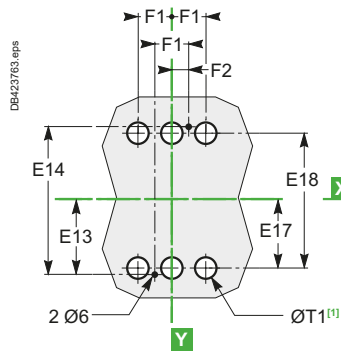
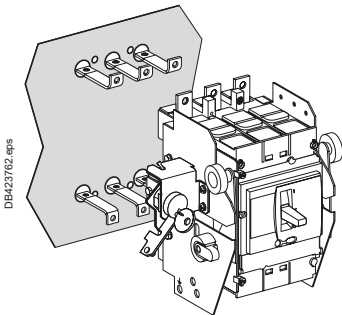

[1] The ØT1 holes are required for rear connection only (for two-pole circuit breakers, the middle holes are not required).

### On rails

#### 2/3P

#### 4P

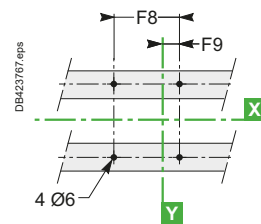
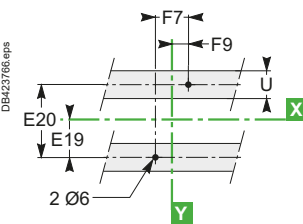
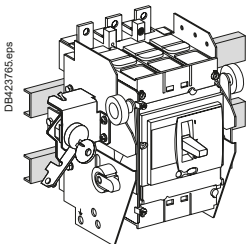

Type	A10	A11	A12	A13	B3	B4	B5	B6	B7	C3	D1	E9	E10	E11	E12	E13	E14
NSX100/160/250	175	210	106.5	103.5	92.5	185	216	220	251	126	75	95	190	87	174	77.5	155
NSX400/630	244	281	140	140	110	220	250	265	295	168	100	150	300	137	274	125	250
Type	E15	E16	E17	E18	E19	E20	F1	F2	F3	F7	F8	F9	F10	F11	F12	ØT1	U
NSX100/160/250	79	158	61	122	37.5	75	35	17.5	70	70	105	35	74	148	183	24	≤ 32
NSX400/630	126	252	101	202	75	150	45	22.5	90	100	145	50	91.5	183	228	33	≤ 35



# ComPact NSX dimensions and mounting

ComPact NSX100 to 630 Vigi add-on plug-in and withdrawable versions

## Dimensions - plug-in version

### NSX100 to 250

3/4P

### NSX400/630

3/4P

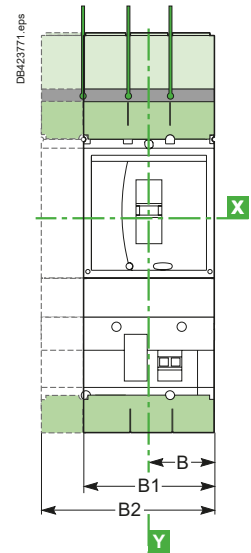
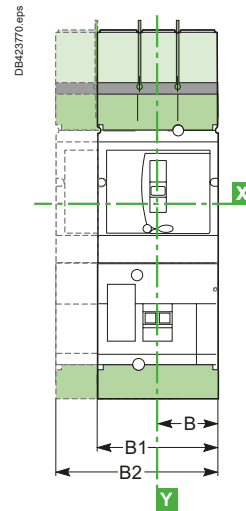
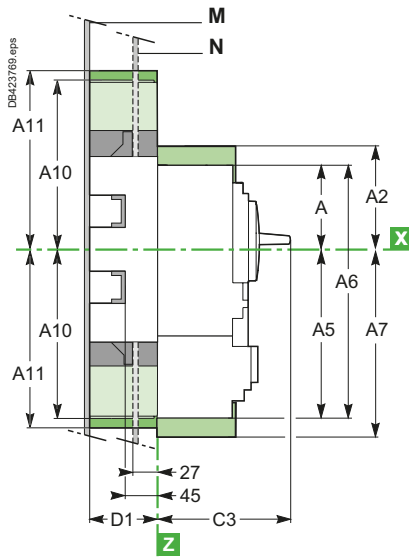
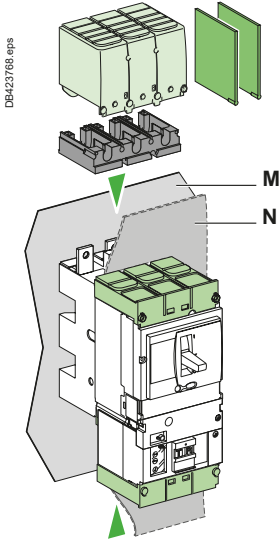

Interphase barriers for base.  
 Short terminal shields on circuit breaker.

Long terminal shields (also available for NSX400/630 spreaders with 52.5 mm pitch: B1 = 157.5 mm, B2 = 210 mm).  
 Adapter for base, required to mount long terminal shields or interphase barriers.

## Dimensions - withdrawable version

### NSX100 to 630

3P

4P

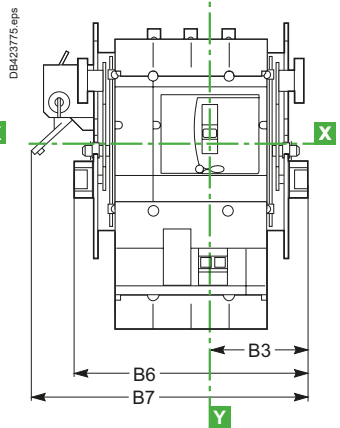
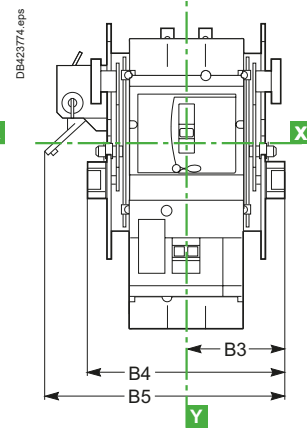
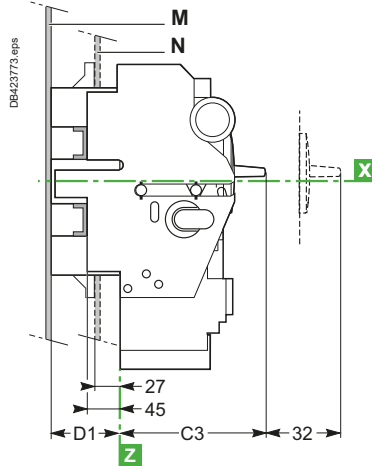
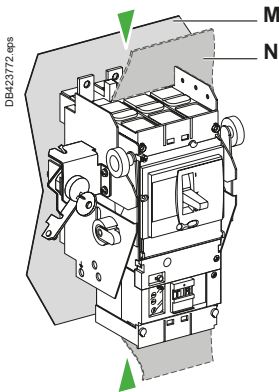

## Mounting

### Through front panel (N)

See ComPact NSX100 to 630 plug-in version, [page E-38](#), or withdrawable version, [page E-40](#)

### On backplate (M)

See ComPact NSX100 to 630 plug-in version, [page E-39](#), or withdrawable version, [page E-41](#)

### On rails

See ComPact NSX100 to 630 plug-in version, [page E-39](#), or withdrawable version, [page E-41](#)

Type	A	A2	A5	A6	A7	A10	A11	B	B1	B2	B3	B4	B5	B6	B7	C3	D1
NSX100/160/250	80.5	94	155.5	236	169	175	210	52.5	105	140	92.5	185	216	220	251	126	75
NSX400/630	127.5	142.5	227.5	355	242.5	244	281	70	140	185	110	220	250	265	295	168	100

# ComCompact NSX dimensions and mounting

## Visu function for ComCompact NSX100 to 250 fixed version

### Dimensions - combination with ComCompact INV100 to 250

3P

4P

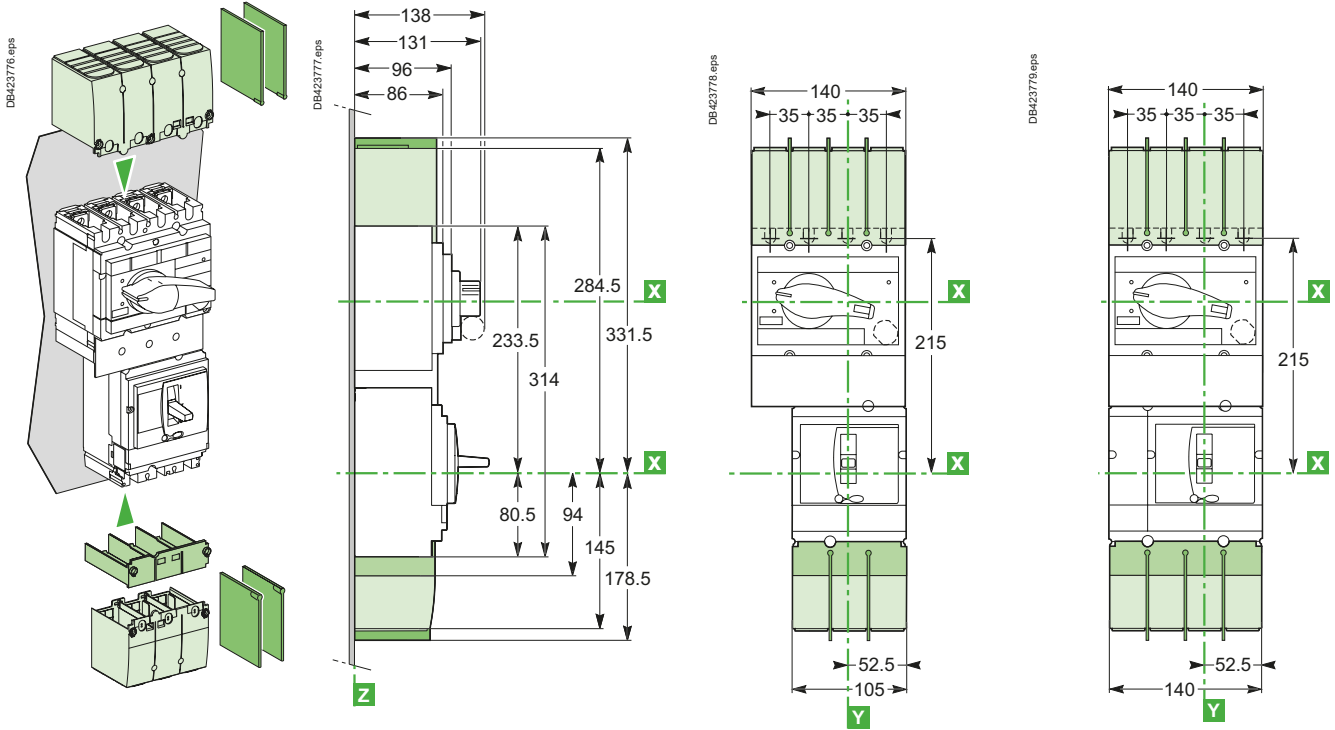

- Interphase barriers.
- Short terminal shields.
- Long terminal shields.

### Mounting

On rails or backplate

3P

4P

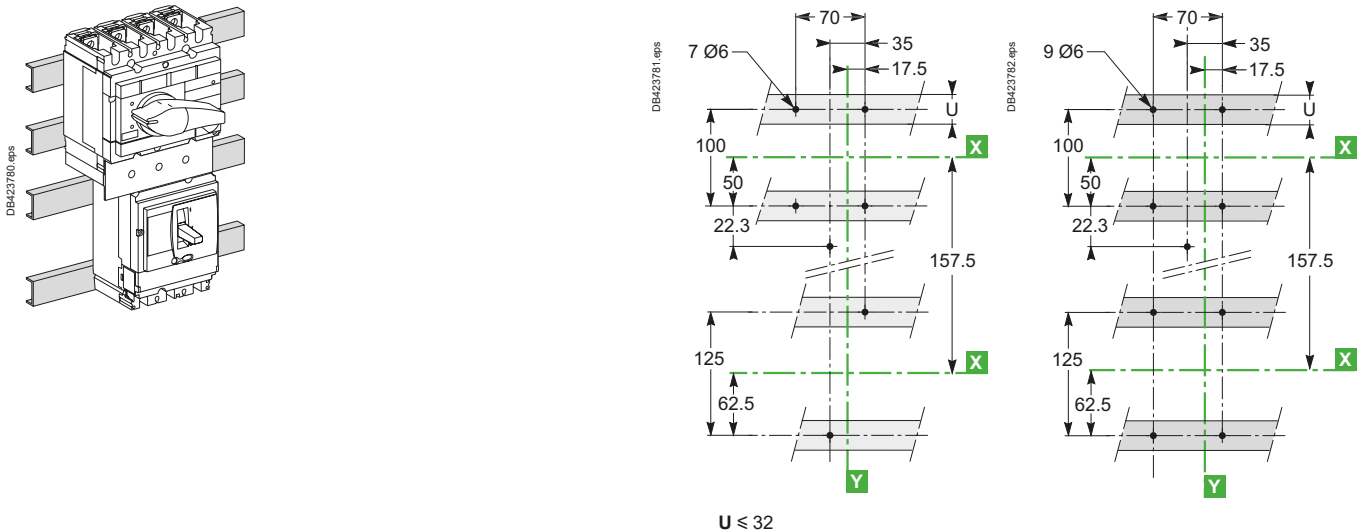

# ComPact NSX dimensions and mounting

Visu function for ComPact NSX400/630 fixed version

## Dimensions - combination with ComPact INV400 to 630

3P

4P

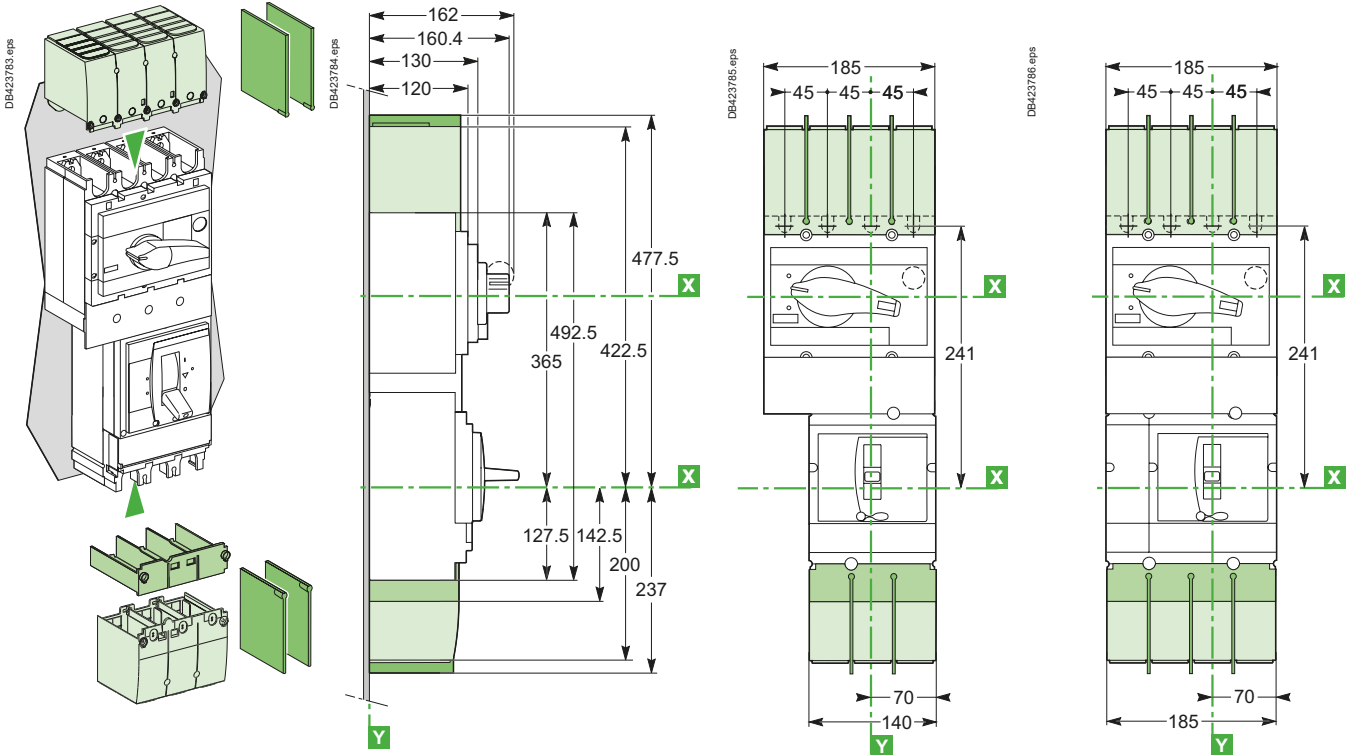

- Interphase barriers for base.
- Short terminal shields.
- Long terminal shields.

## Mounting

On rails or backplate

3P

4P

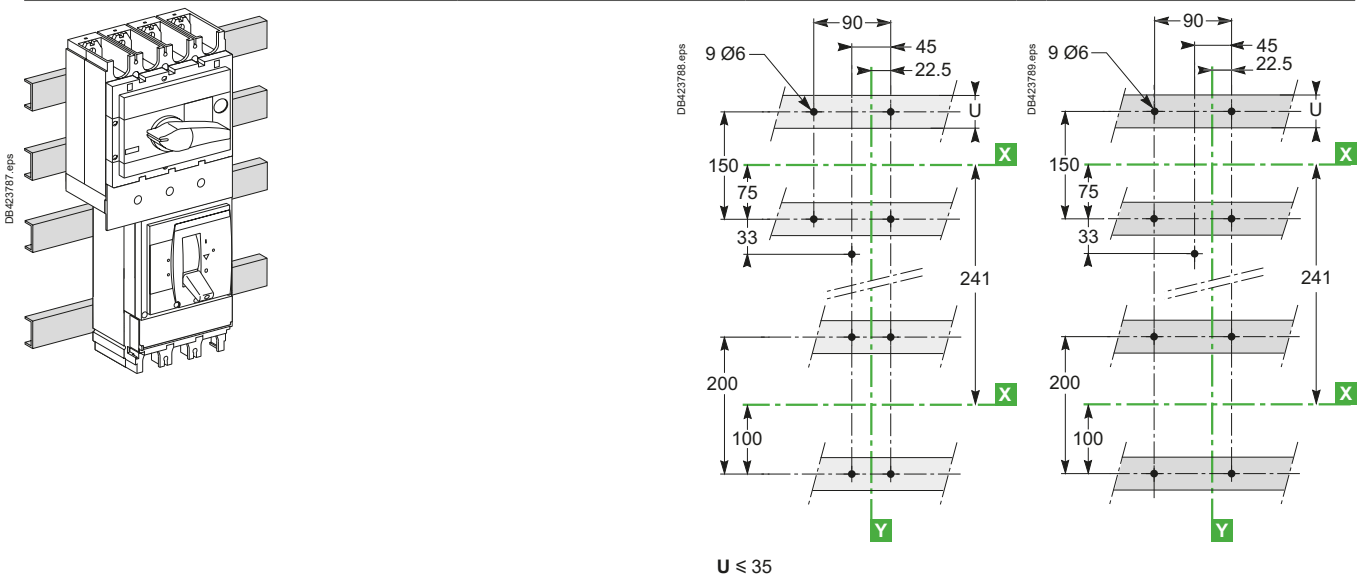



# ComPact NSX dimensions and mounting

## Motor mechanism module for ComPact NSX100 to 630

### Dimensions

3P

4P

#### Fixed circuit breaker

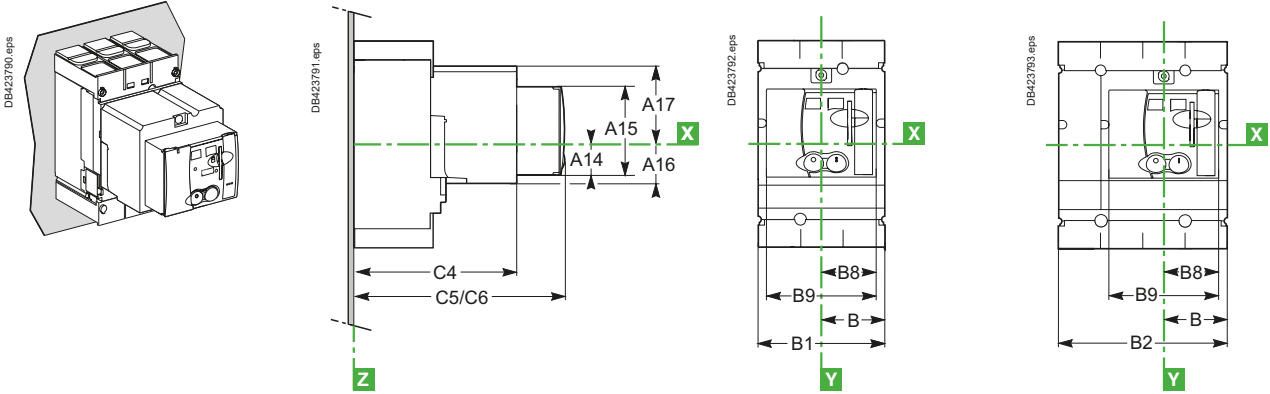

C5: without keylock  
C6: with keylock

#### Plug-in circuit breaker

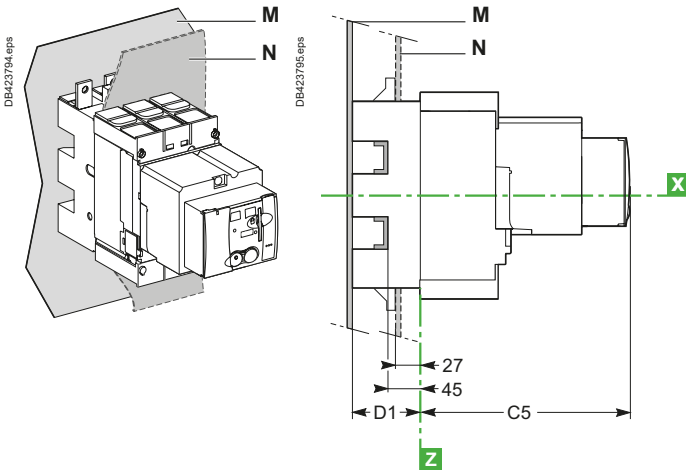

#### Withdrawable circuit breaker

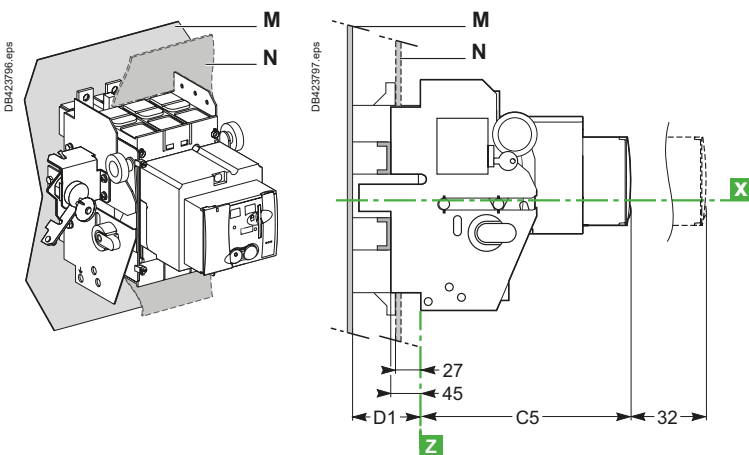

Type	A14	A15	A16	A17	B	B1	B2	B8	B9	C4	C5	C6	D1
NSX100/160/250	27.5	73	34.5	62.5	52.5	105	140	45.5	91	143	182	209.5	75
NSX400/630	40	123	52	100	70	140	185	61.5	123	215	256	258	100



# ComPact NSX dimensions and mounting

## Direct rotary handle for ComPact NSX100 to 630

### Dimensions

#### Fixed circuit breaker

### 3P

### 4P

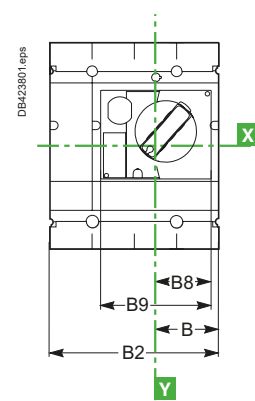
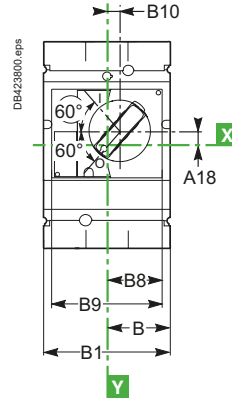
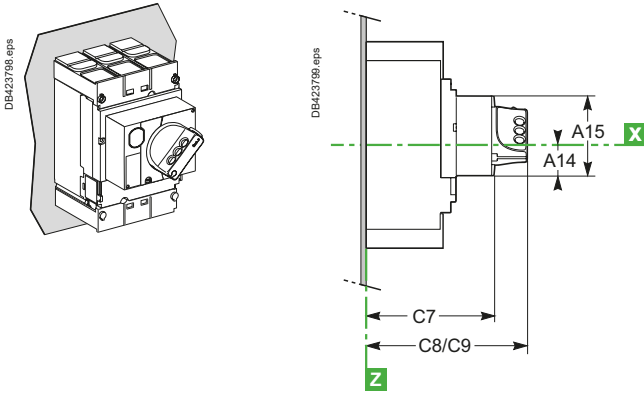

C8: without keylock  
C9: with keylock

#### Plug-in circuit breaker

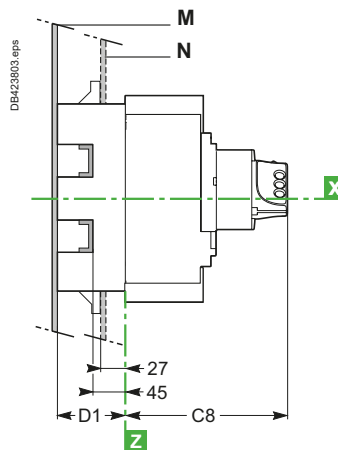
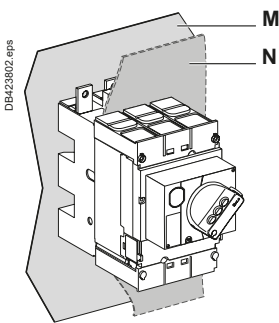

#### Withdrawable circuit breaker

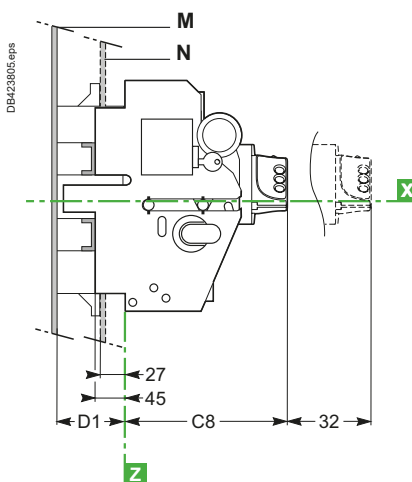
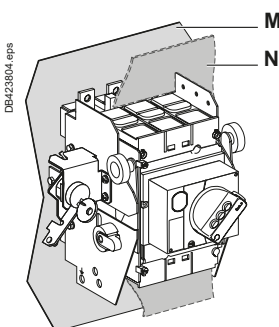

Type	A14	A15	A18	B	B1	B2	B8	B9	B10	C7	C8	C9	D1
NSX100/160/250	27.5	73	9	52.5	105	140	45.5	91	9.25	121	155	164	75
NSX400/630	40	123	24.6	70	140	185	61.5	123	5	145	179	188	100

# ComPact NSX dimensions and mounting

## MCC and CNOMO type direct rotary handles for ComPact NSX100 to 630 fixed version

### Dimensions

#### MCC type direct rotary handle

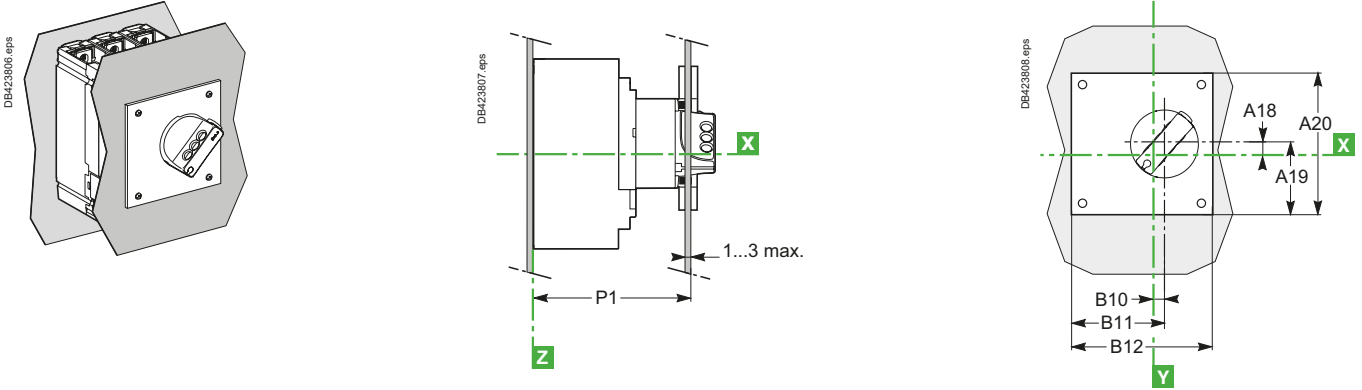

#### CNOMO type direct rotary handle

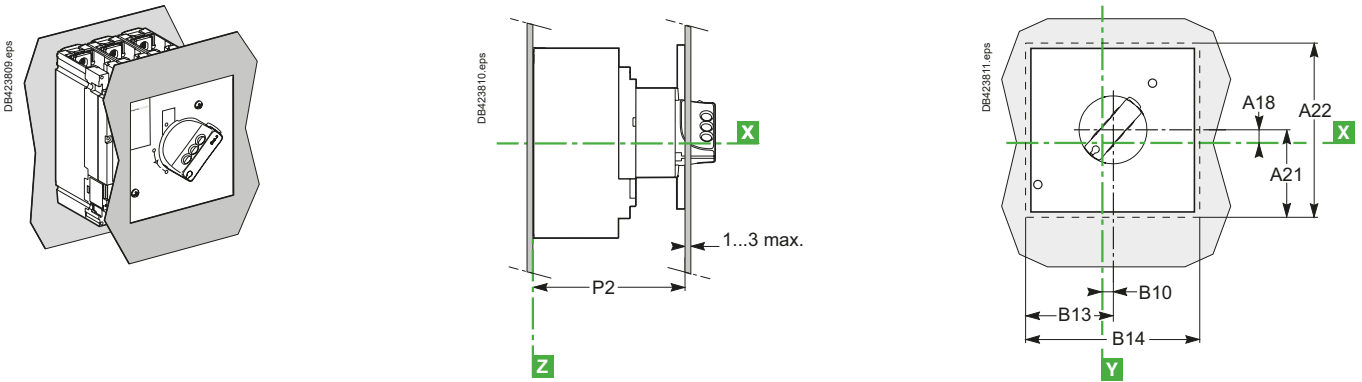

#### Front-panel cutout

#### NSX100 to 250

#### NSX400/630

#### MCC type direct rotary handle

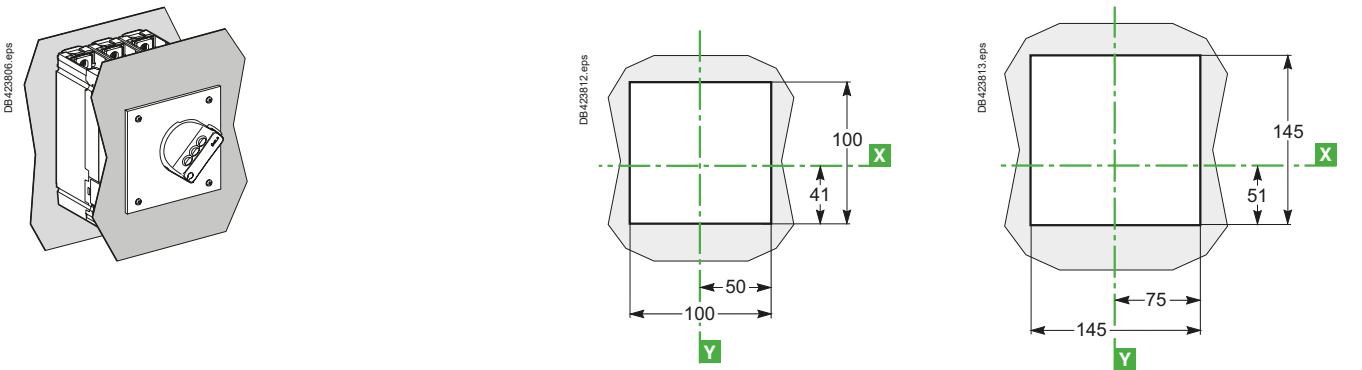

#### CNOMO type direct rotary handle

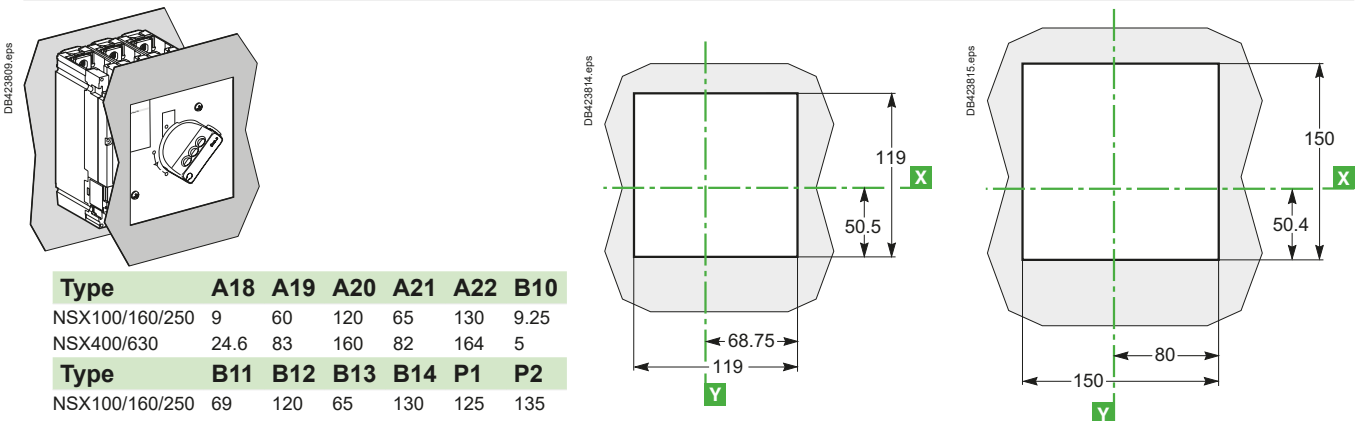

Type	A18	A19	A20	A21	A22	B10
NSX100/160/250	9	60	120	65	130	9.25
NSX400/630	24.6	83	160	82	164	5
Type	B11	B12	B13	B14	P1	P2
NSX100/160/250	69	120	65	130	125	135
NSX400/630	85	160	82	164	149	158



# ComPact NSX dimensions and mounting

## Extended rotary handle for ComPact NSX100 to 630

### Dimensions

#### Fixed and plug-in circuit breakers

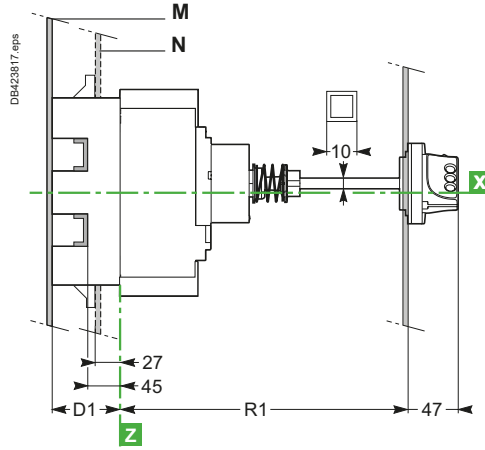
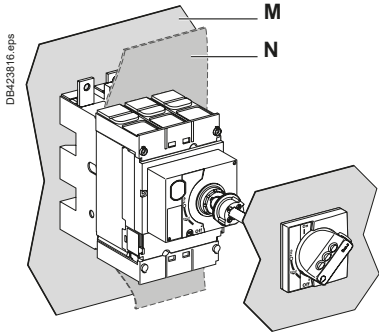

Cutout for shaft (mm)

Type	R1
NSX100/160/250	min. 171 max. 600
NSX400/630	min. 195 max. 600

#### Withdrawable circuit breaker

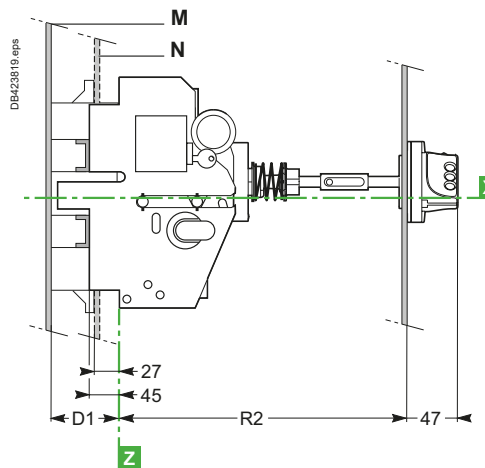
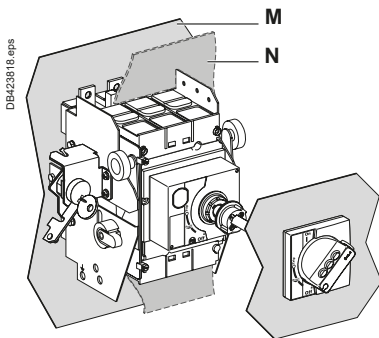

Cutout for shaft (mm)

Type	R2
NSX100/160/250	min. 248 max. 600
NSX400/630	min. 272 max. 600

E

### Dimensions and front-panel cutout

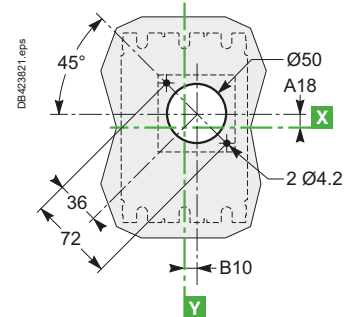
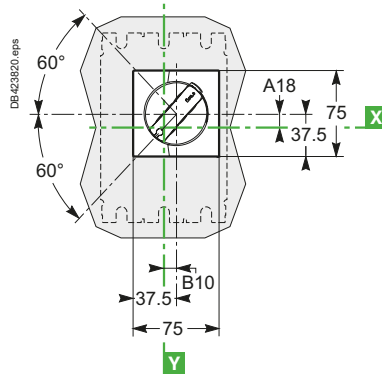

Type	A18	B10	D1
NSX100/160/250	9	9.25	75
NSX400/630	24.6	5	100

# ComPact NSX dimensions and mounting

Indication and measurement modules for ComPact NSX100 to 630 fixed version

## Dimensions of circuit breaker with Ammeter module

## Current-transformer / PowerLogic PowerTag NSX module

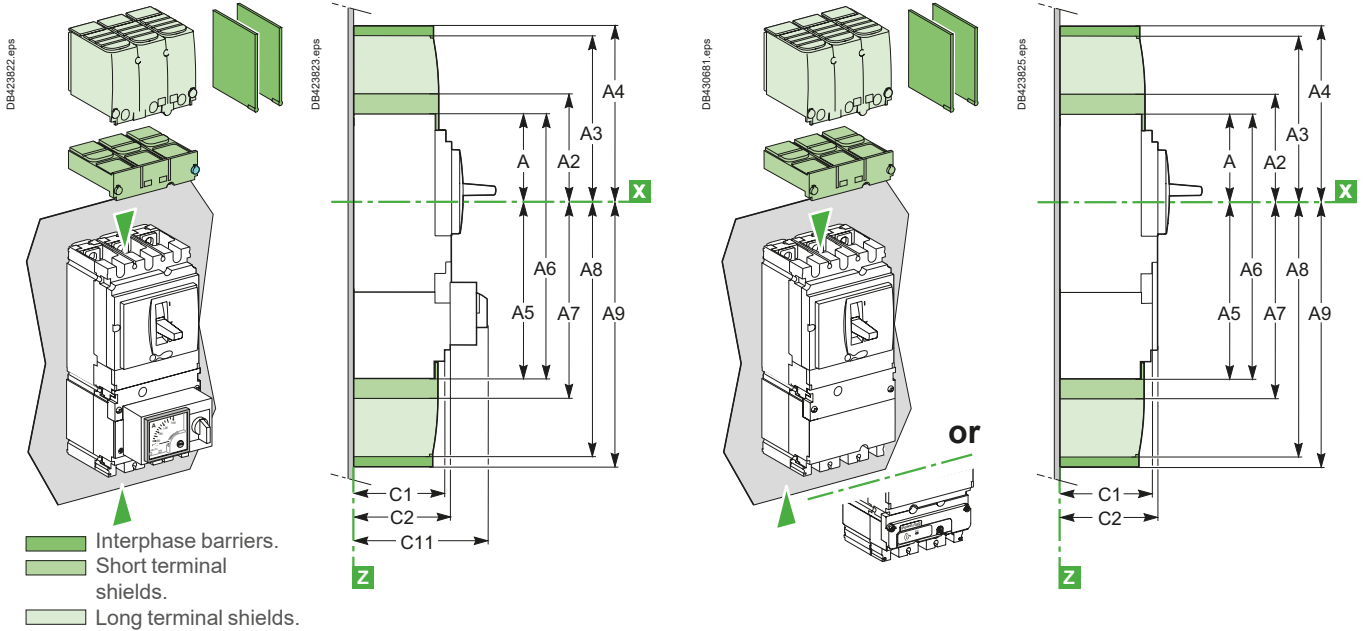

## Mounting

### On backplate

### NSX100 to 250 2/3P

### NSX400/630 3P

### NSX100 to 630 4P

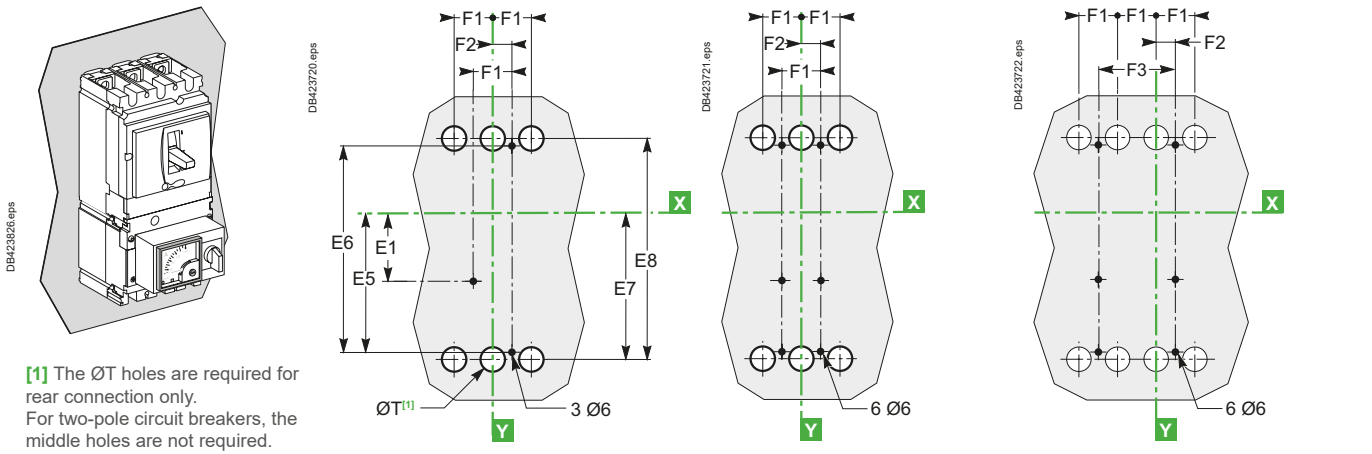

[1] The ØT holes are required for rear connection only. For two-pole circuit breakers, the middle holes are not required.

### On rails

### 2/3P

### 3P

### 4P

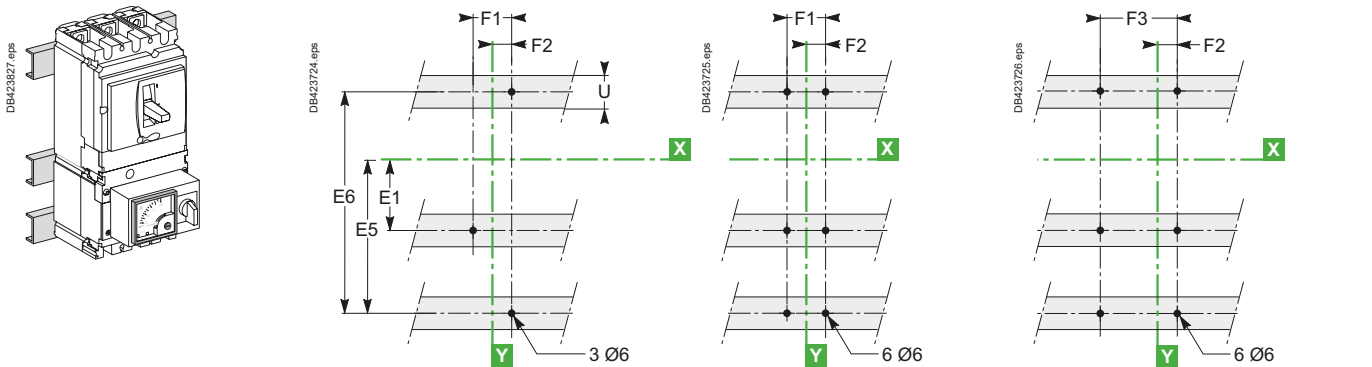

Type	A	A2	A3	A4	A5	A6	A7	A8	A9	C1	C2	C11	E1	E5	E6	E7	E8	F1
NSX100/160/250	80.5	94	145	178.5	155.5	236	169	220	253.5	81	86	137	62.5	137.5	200	145	215	35
NSX400/630	127.5	142.5	200	237	227.5	355	242.5	300	337	95.5	110	162	100	200	300	213.5	327	45
Type	F2	F3	ØT	U	Type	A5	A6	A7	A8	A9	E5	E6	E7	E8				
NSX100/160/250	17.5	70	24	≤ 32	NSX100/160/250 with PowerTag NSX	120.5	201	134	185	219.5	102.5	165	110	180				
NSX400/630	22.5	90	32	≤ 35	NSX400/630 with PowerTag NSX	192.5	320	207.5	265	302.5	165	265	178.5	192				

# ComPact NSX dimensions and mounting

One-piece spreader for ComPact NSX100 to 250 fixed version

## Dimensions

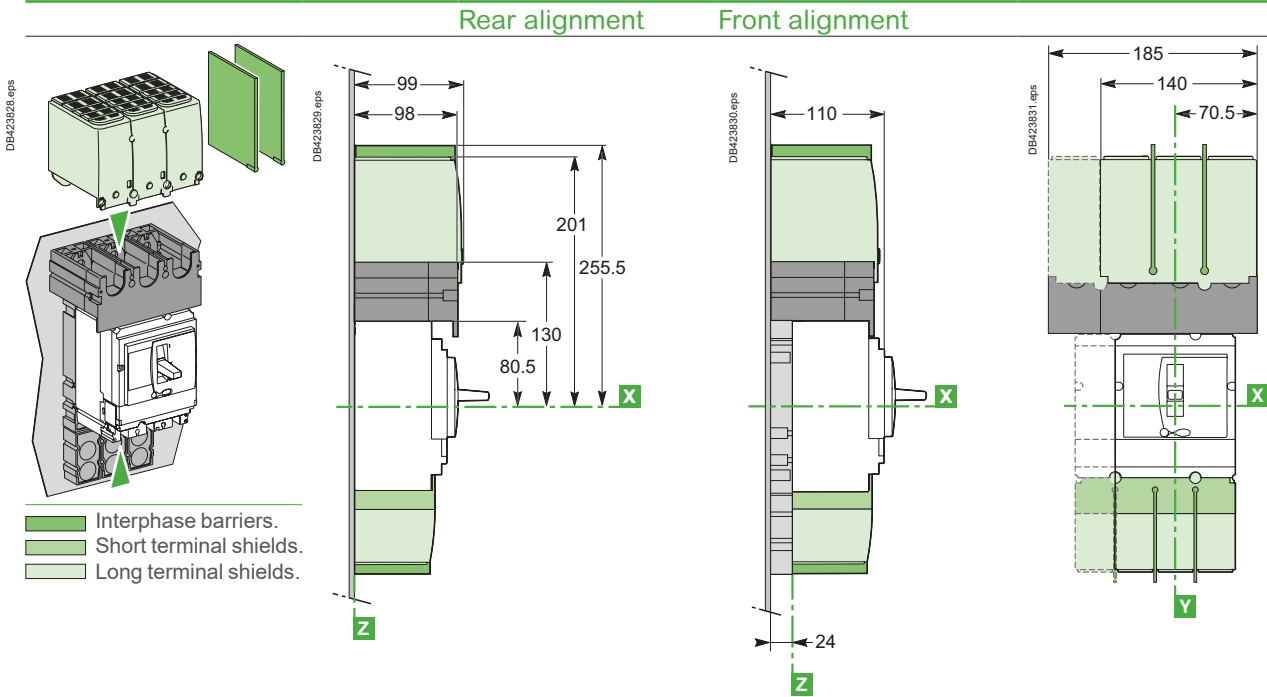

## Mounting

Rear alignment

2/3P

4P

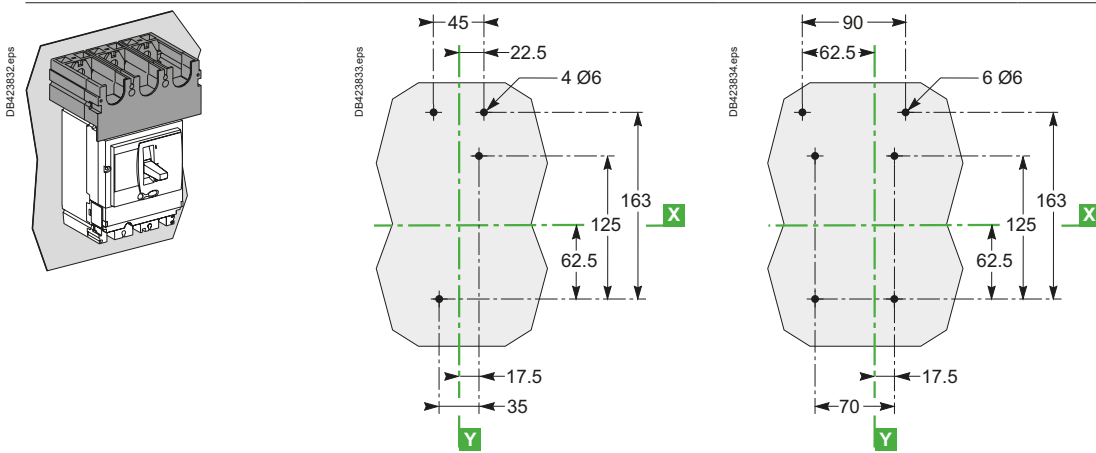

Front alignment

2/3P

4P

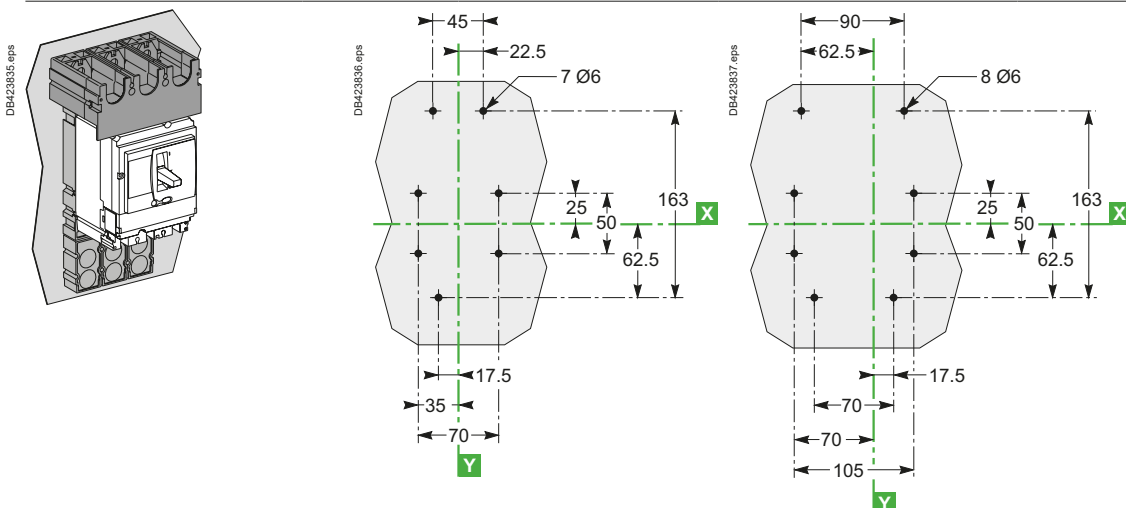

# ComCompact NSX dimensions and mounting

## External modules

### I/O (Input/Output) application module

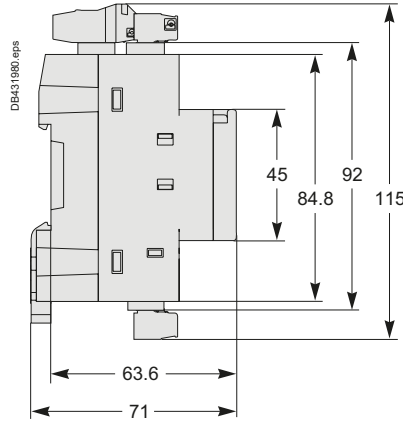
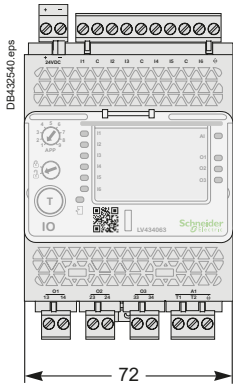

### IFM - Modbus-SL interface

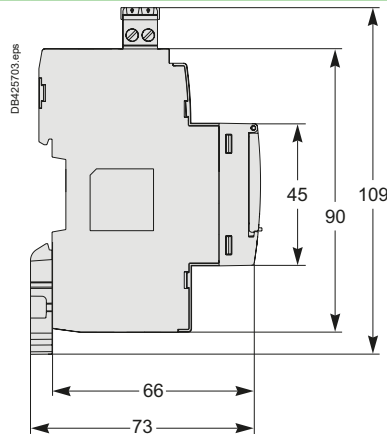
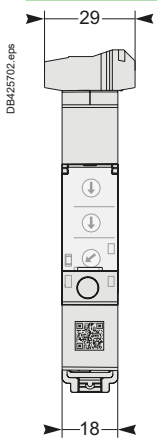

### IFE - Ethernet interface

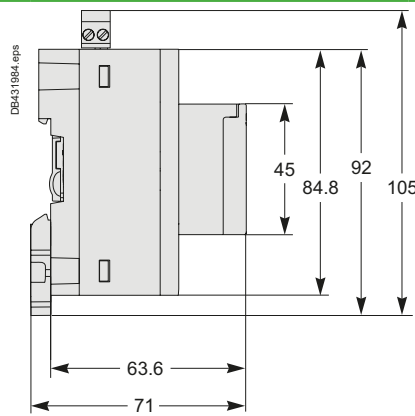
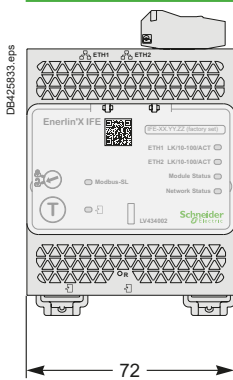

### Com'X 500/510

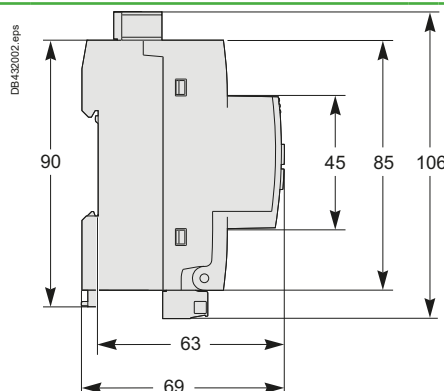
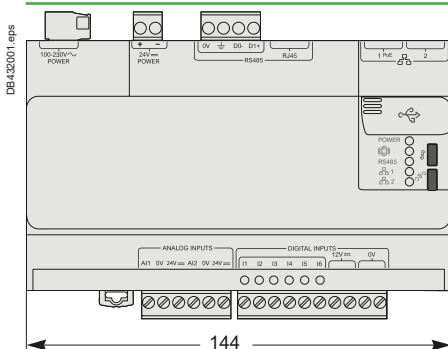

# ComPact NSX dimensions and mounting

## FDM121 switchboard display

### Dimensions

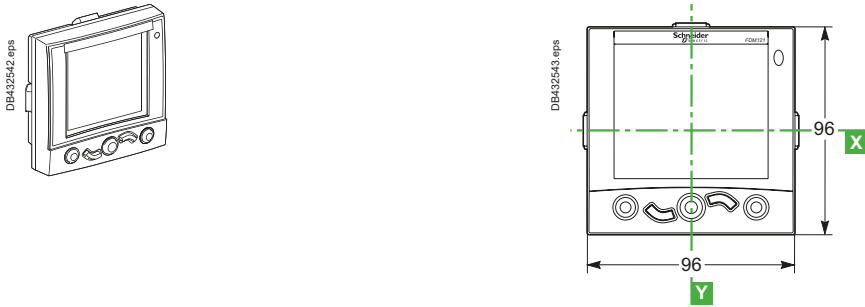

### Mounting

#### Through panel

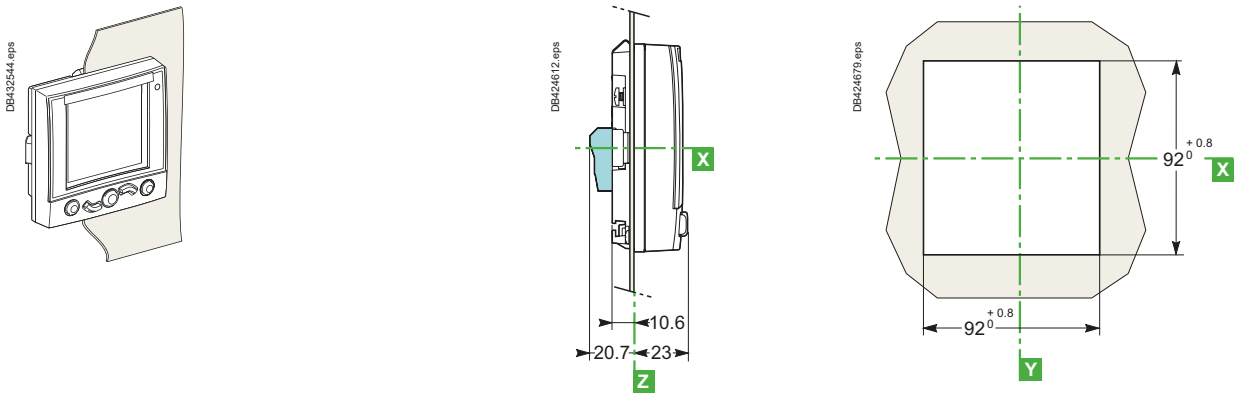

E

#### On panel

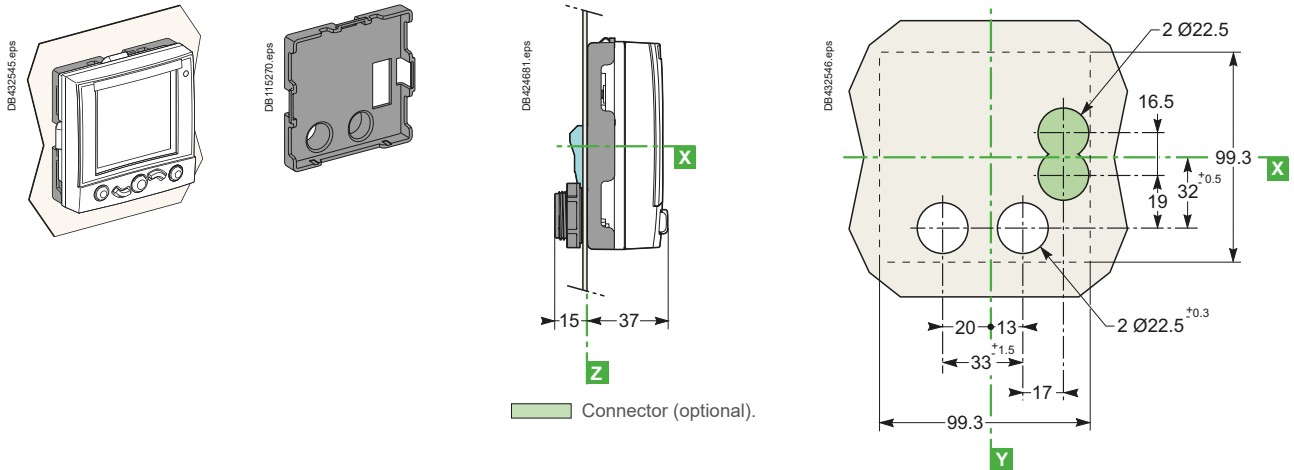



# Switchboard integration

## ComPact NSX dimensions and mounting

### FDM128 switchboard display

#### Dimensions

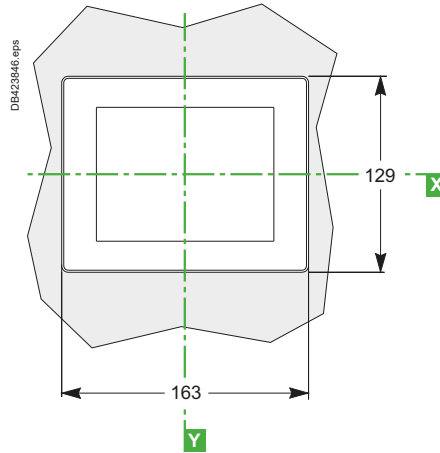
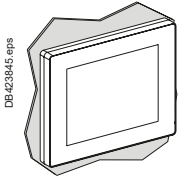

#### Mounting

##### On panel

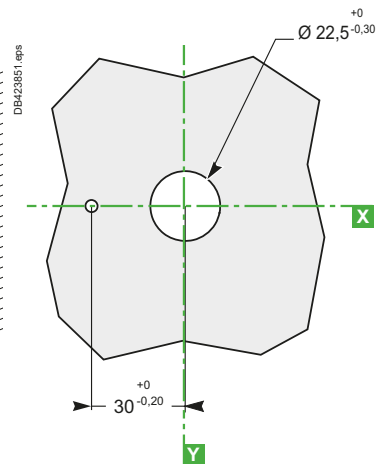
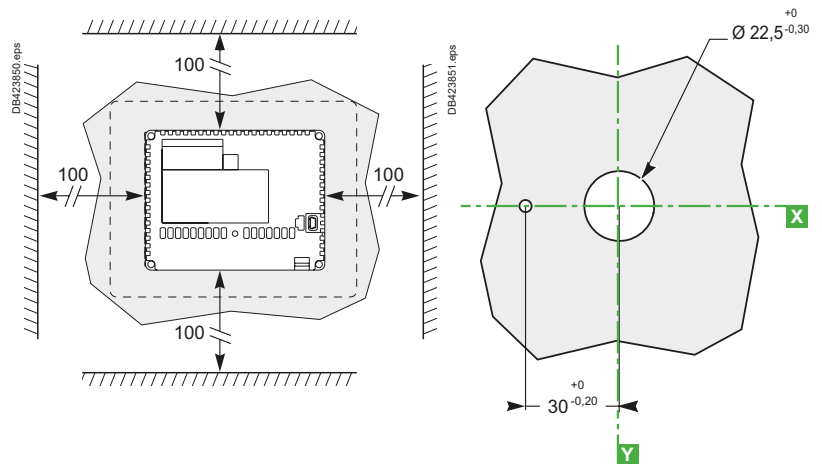
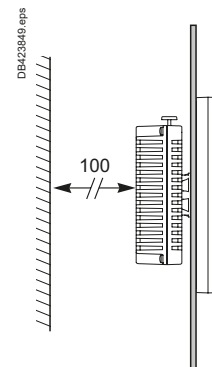
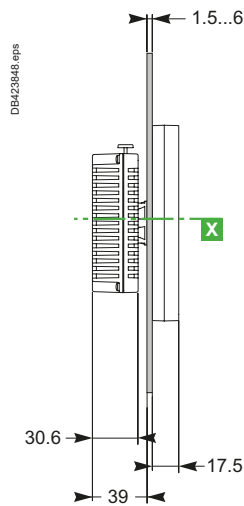
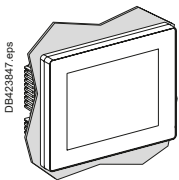

## Switchboard integration

# ComPact NSX front-panel accessories

## ComPact NSX100 to 630

### IP30 front-panel escutcheons

For toggle, rotary handle or motor mechanism module

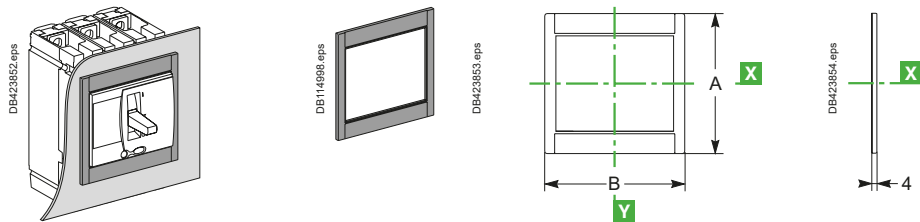

For toggle or rotary handle with access to trip unit

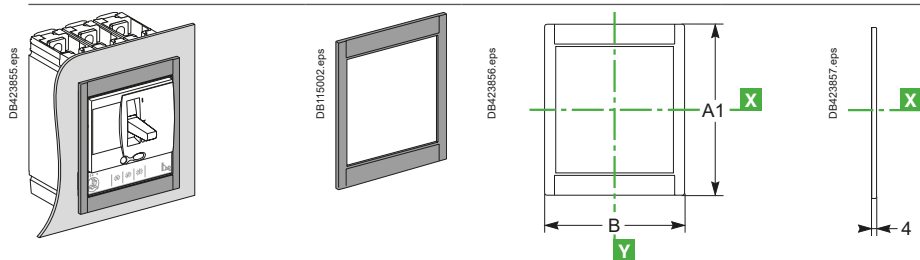

For Vigi add-on

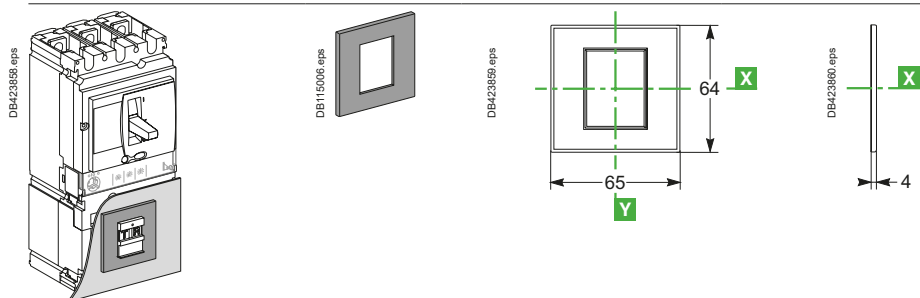

### IP40 front-panel escutcheons

For toggle, rotary handle or motor mechanism module and protection collar

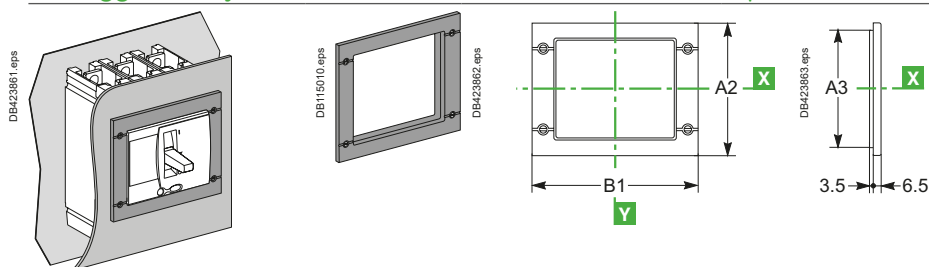

For Vigi add-on with protection collar or ammeter module

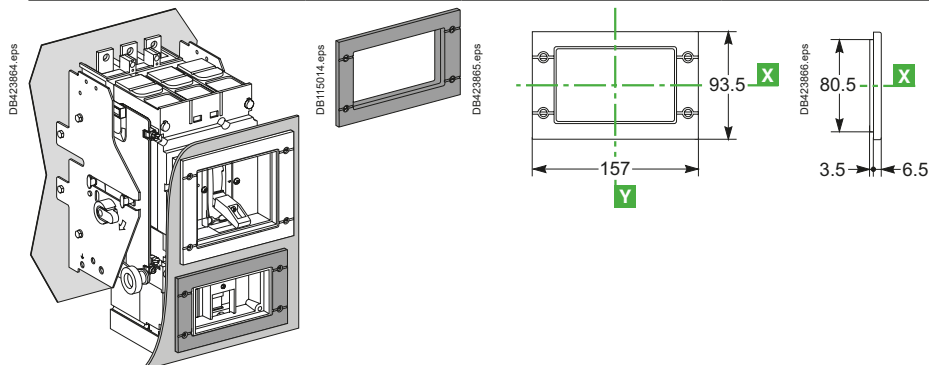

E

# Switchboard integration

## ComPact NSX front-panel accessories

### ComPact NSX100 to 630

#### IP40 front-panel escutcheons (cont.)

For Vigi add-on

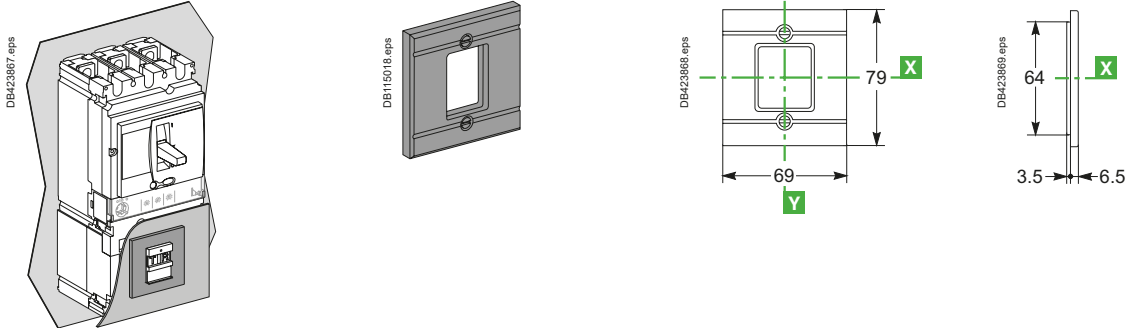

#### Protection collars for IP40 front-panel escutcheons

For toggle

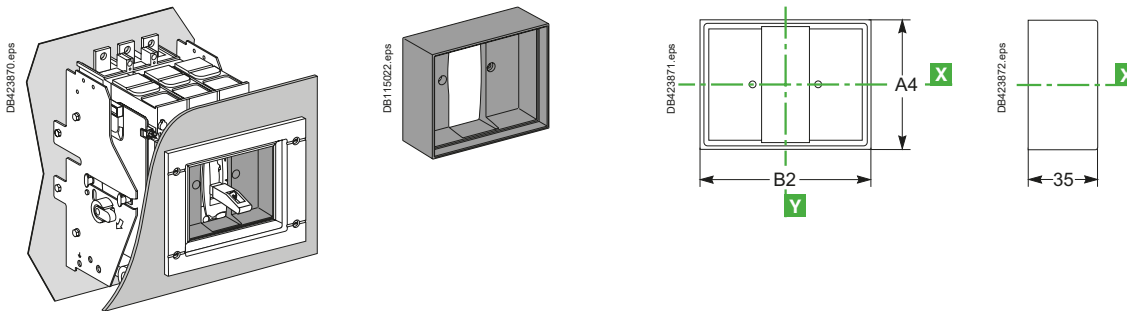

For Vigi add-on

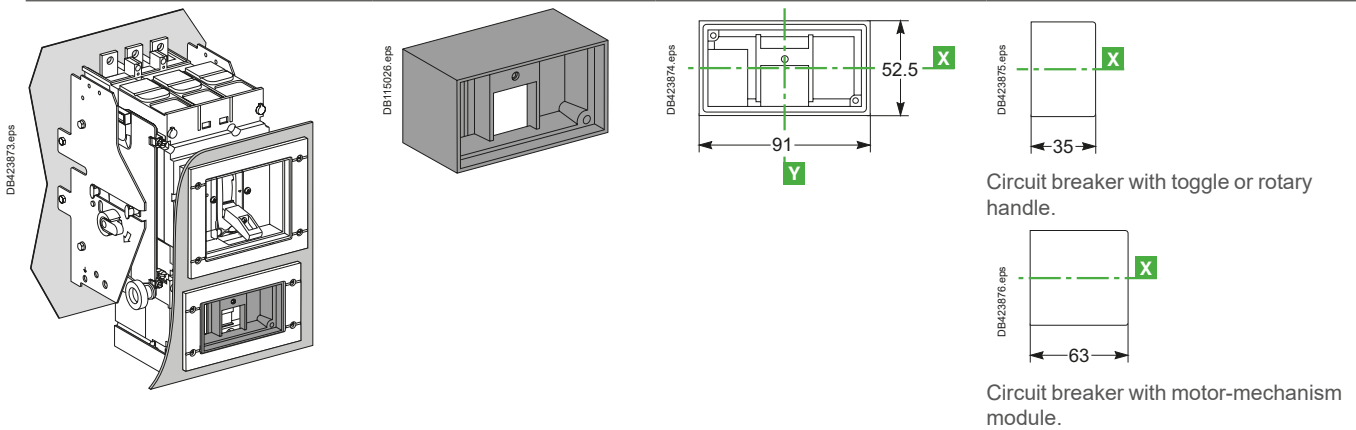

#### IP43 toggle cover

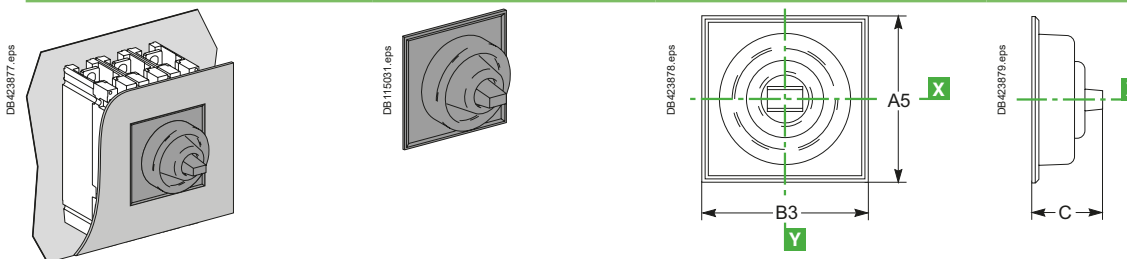

Type	A	A1	A2	A3	A4	A5	B	B1	B2	B3	C
NSX100/160/250	113	138	114	101	73	85	113	157	91	103	40
NSX400/630	163	211	164	151	122.5	138	163	189	122.5	138	60

# ComPact NSX front-panel cutouts

## ComPact NSX100 to 630 fixed version

### Bare sheet metal

### NSX100 to 250

### NSX400/630

For toggle

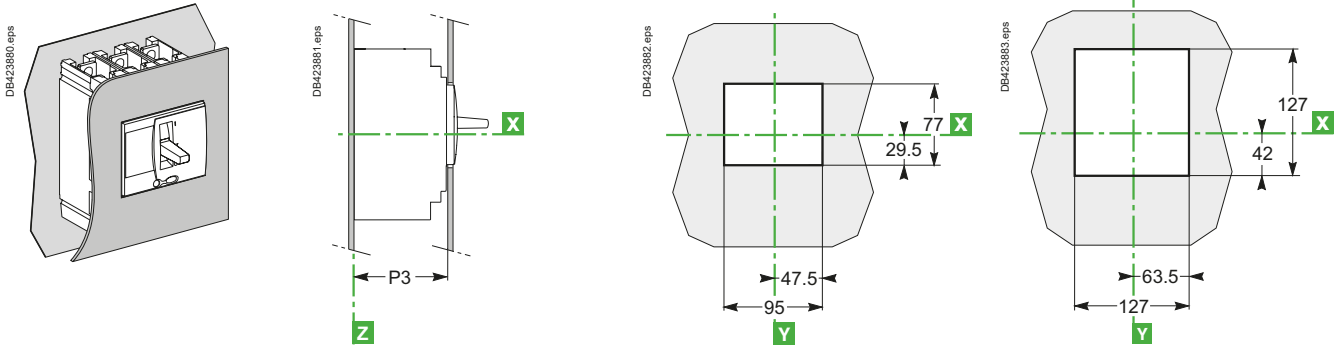

For toggle with access to trip unit

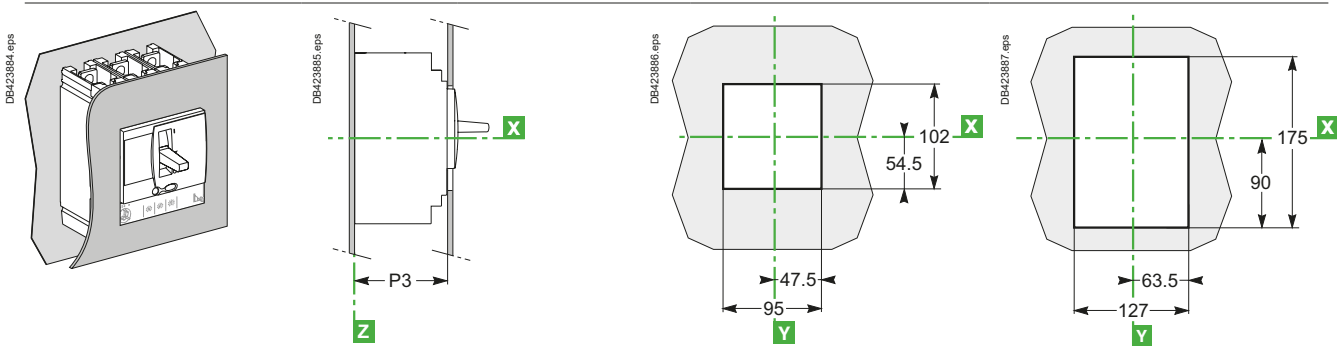

E

### With IP30 front-panel escutcheon

### NSX100 to 250

### NSX400/630

For toggle

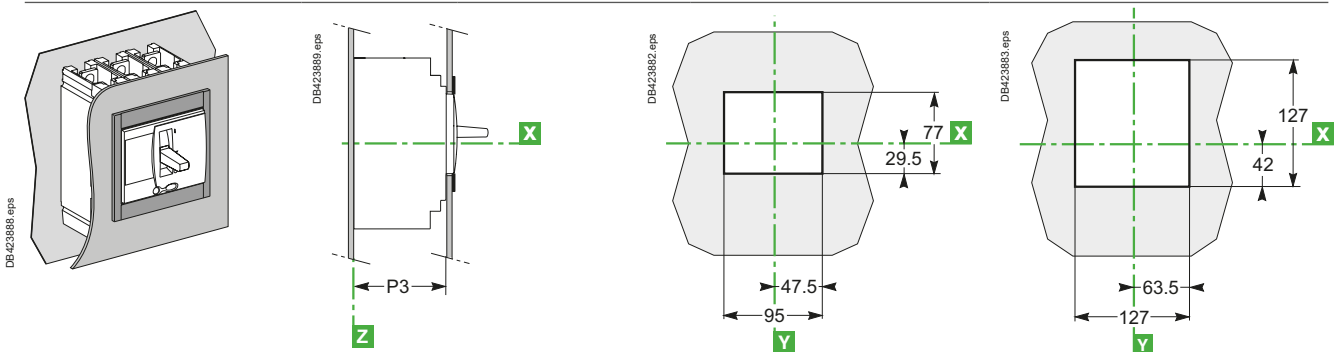

For toggle with access to trip unit

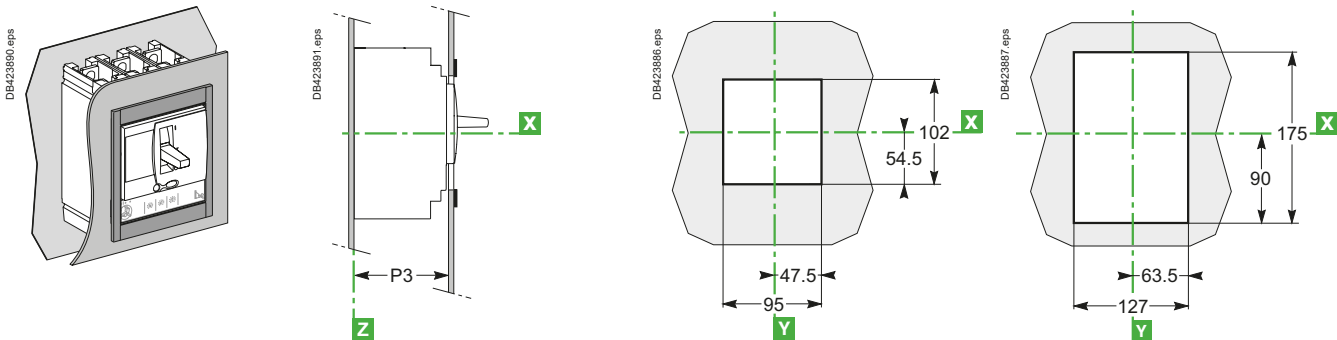

# Switchboard integration

## ComPact NSX front-panel cutouts

### ComPact NSX100 to 630 fixed version

#### With IP40 front-panel escutcheon

For toggle

#### NSX100 to 250

#### NSX400/630

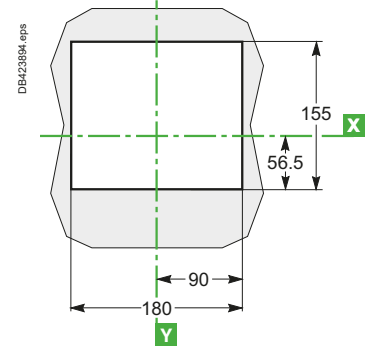
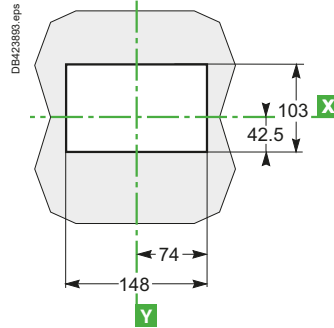
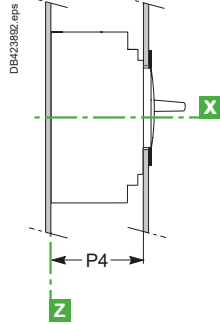
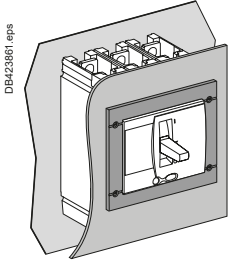

#### With IP43 toggle cover

For toggle

#### NSX100 to 250

#### NSX400/630

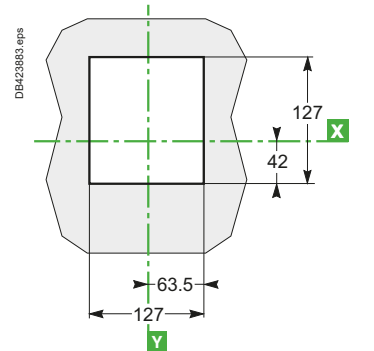
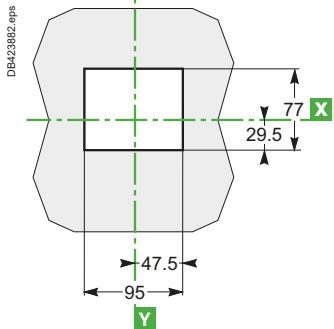
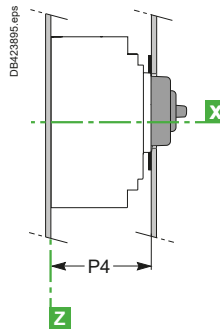
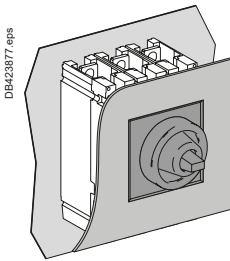

Type	P3	P4
NSX100/160/250	88	89
NSX400/630	112	113

**Note:** door cutout dimensions are given for a device position in the enclosure where  $D \geq 100 + (h \times 5)$  with respect to the door hinge.

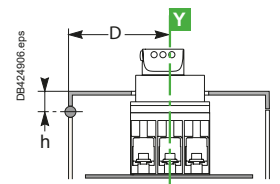

# ComPact NSX front-panel cutouts

## ComPact NSX100 to 630 Vigi add-on fixed version

### Bare sheet metal

### NSX100 to 250

### NSX400/630

For toggle

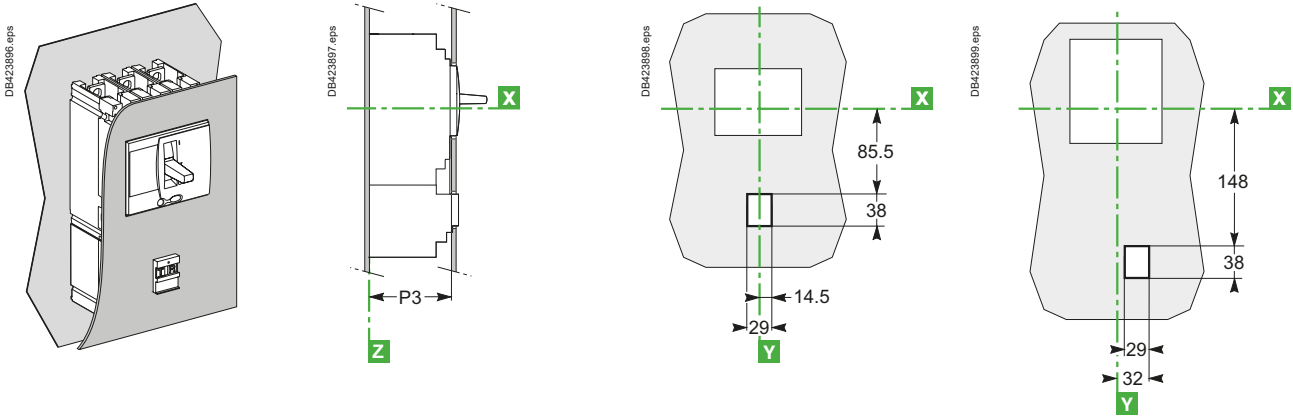

For toggle with access to trip unit

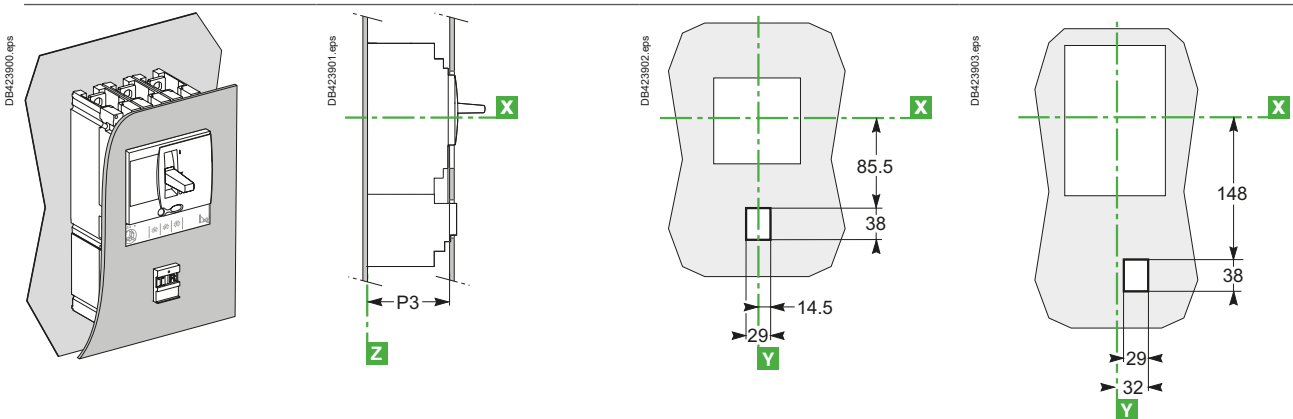

E

### With IP30 front-panel escutcheon

### NSX100 to 250

### NSX400/630

For toggle

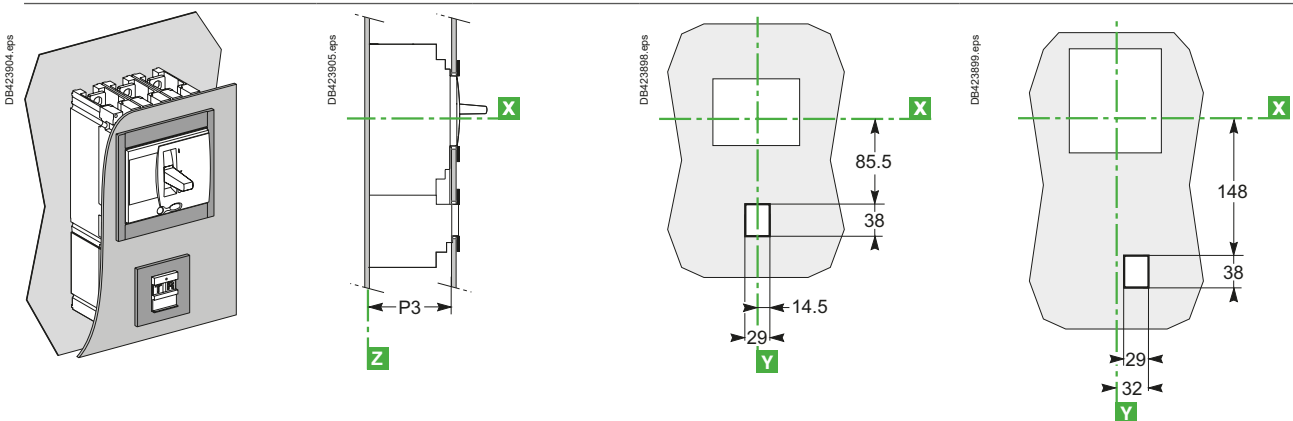

# ComPact NSX front-panel cutouts

## ComPact NSX100 to 630 Vigi add-on fixed version

### With IP30 front-panel escutcheon

### NSX100 to 250

### NSX400/630

For toggle with access to trip unit

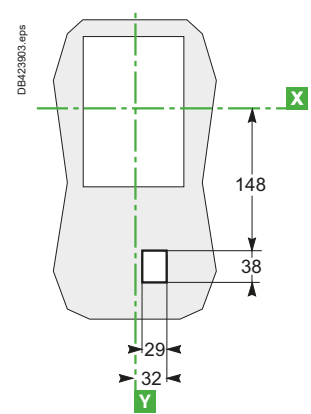
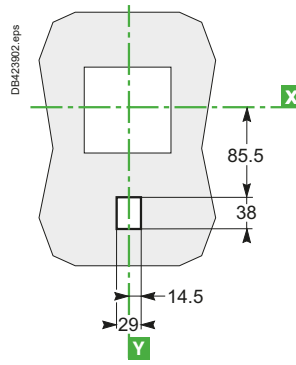
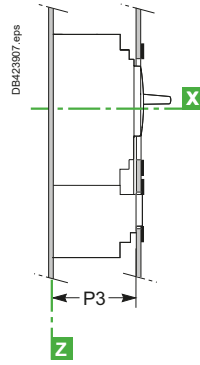
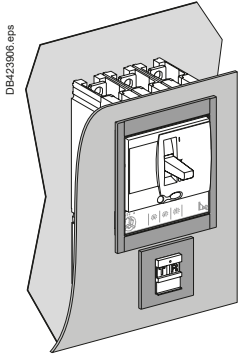

### With IP40 front-panel escutcheon

### NSX100 to 250

### NSX400/630

For toggle

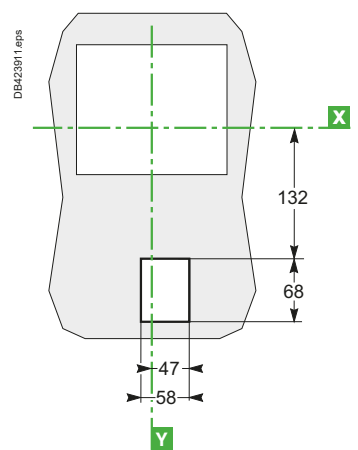
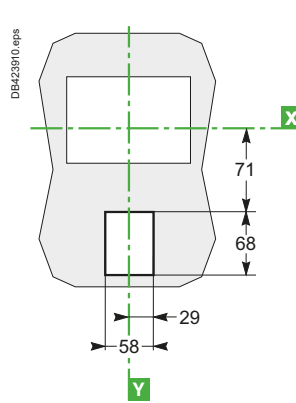
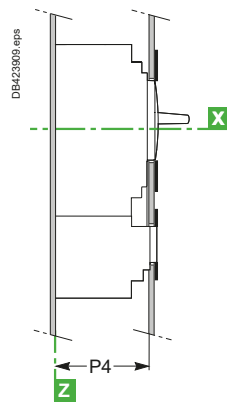
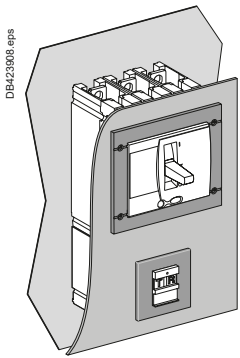

Type	P3	P4
NSX100/160/250	88	89
NSX400/630	112	113

**Note:** door cutout dimensions are given for a device position in the enclosure where  $\Delta \geq 100 + (h \times 5)$  with respect to the door hinge.

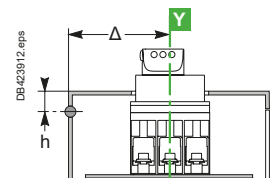

# ComPact NSX front-panel cutouts

ComPact NSX100 to 630 plug-in and withdrawable versions

## Plug-in version

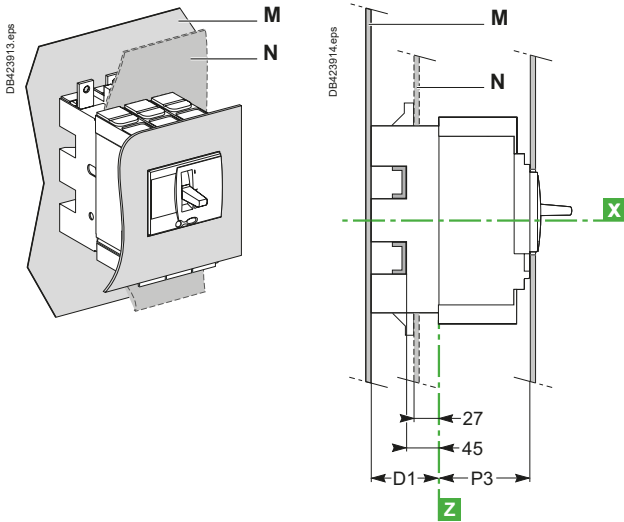

**Bare sheet metal**

See ComPact NSX100 to 630 fixed version, [page E-56](#)

**With IP30 front-panel escutcheon**

See ComPact NSX100 to 630 fixed version, [page E-56](#)

**With IP40 front-panel escutcheon**

See ComPact NSX100 to 630 fixed version, [page E-57](#)

**With toggle cover**

See ComPact NSX100 to 630 fixed version, [page E-57](#)

E

## Withdrawable version

NSX100 to 250

NSX400/630

With protection collar and IP40 front-panel escutcheon

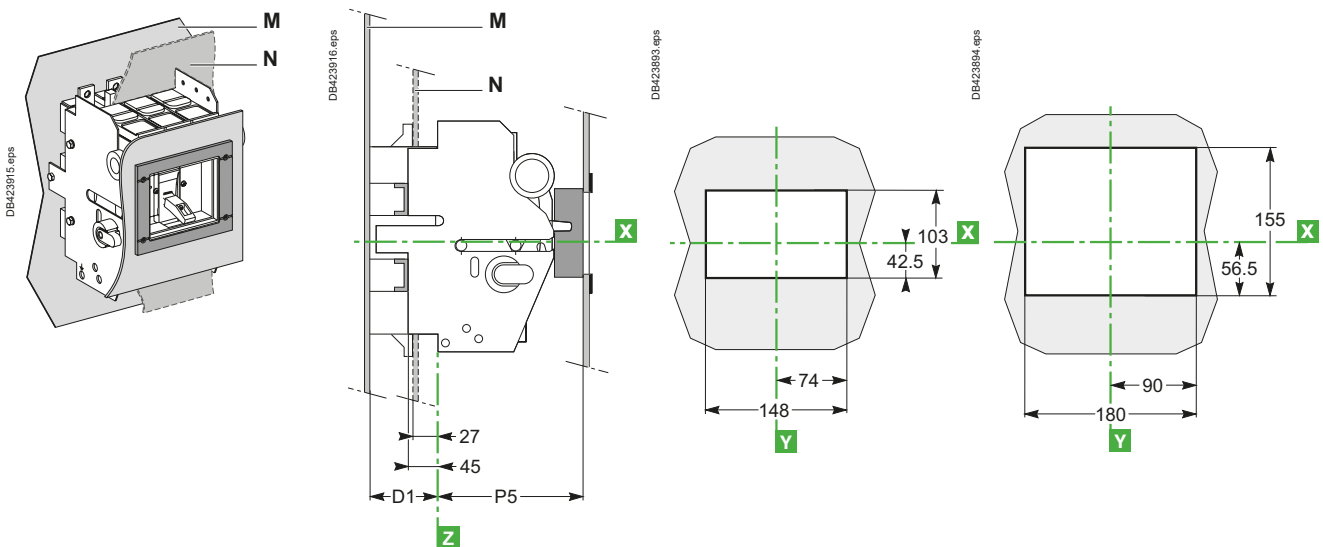



# ComPact NSX front-panel cutouts

## ComPact NSX100 to 630 Vigi add-on plug-in and withdrawable versions

### Plug-in version

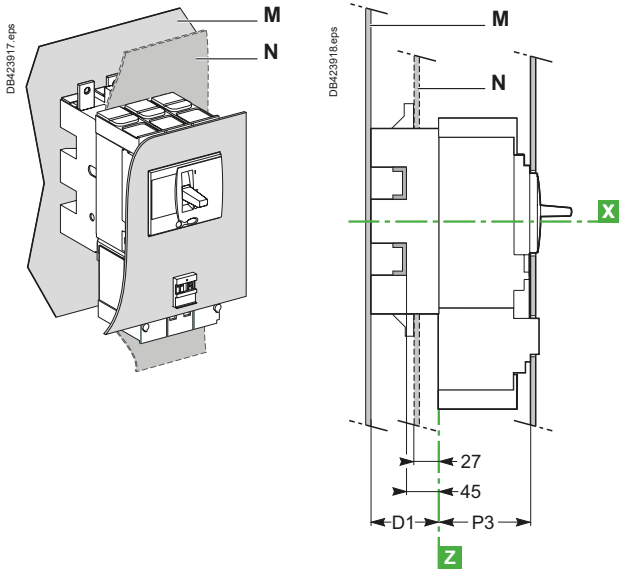

#### Bare sheet metal

See ComPact NSX100 to 630 fixed version, [page E-58](#)

#### With IP30 front-panel escutcheon

See ComPact NSX100 to 630 fixed version, [page E-58](#)

#### With IP40 front-panel escutcheon

See ComPact NSX100 to 630 fixed version, [page E-59](#)

### Withdrawable version

#### NSX100 to 250

#### NSX400/630

With protection collar and IP40 front-panel escutcheon

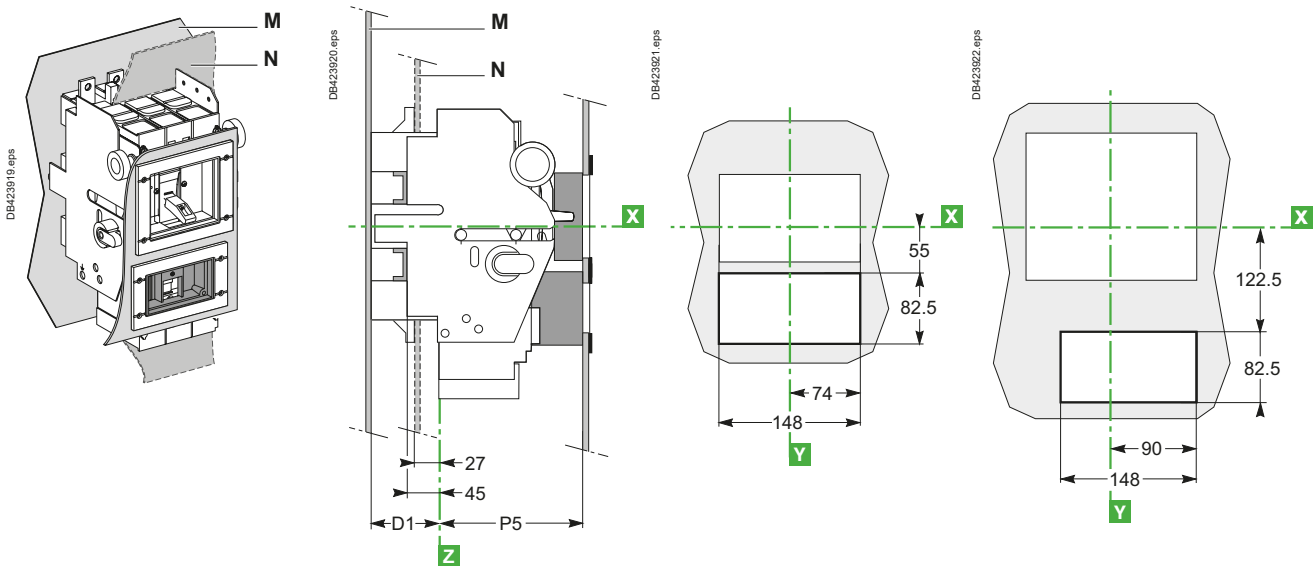

Type	D1	P3	P5
NSX100/160/250	75	88	123
NSX400/630	100	112	147

**Note:** door cutout dimensions are given for a device position in the enclosure where  $\Delta \geq 100 + (h \times 5)$  with respect to the door hinge.

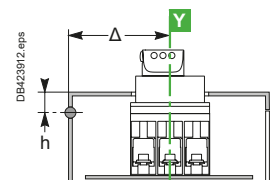

# ComPact NSX front-panel cutouts

## Visu function for ComPact NSX100 to 630 fixed version

### ComPact NSX100 to 250 with ComPact INV100 to 250 Visu function

Bare sheet metal

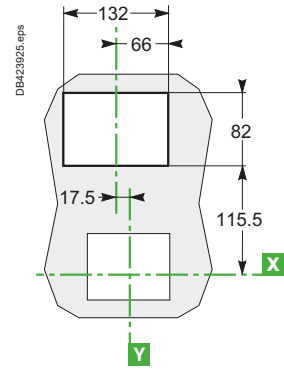
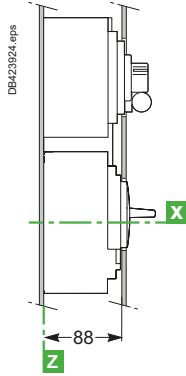
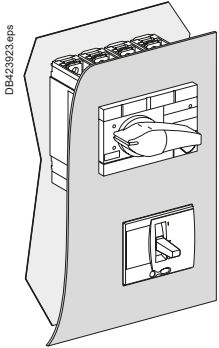

With IP40 front-panel escutcheon

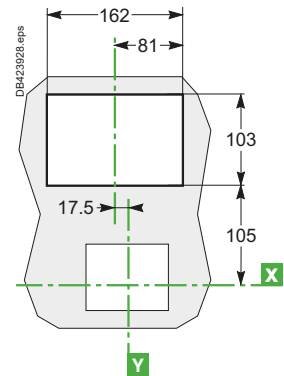
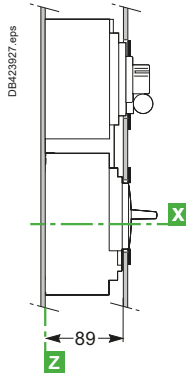
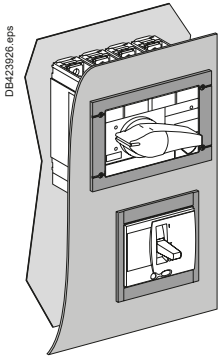

E

### ComPact NSX400/630 with ComPact INV400 to 630 Visu function

Bare sheet metal

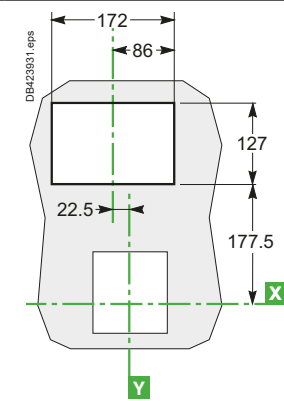
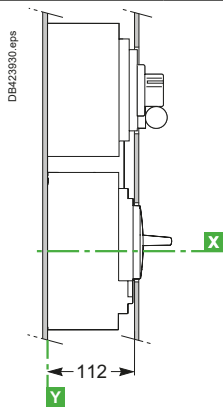
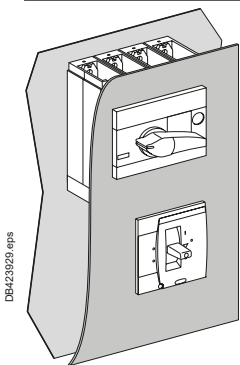

With IP40 front-panel escutcheon

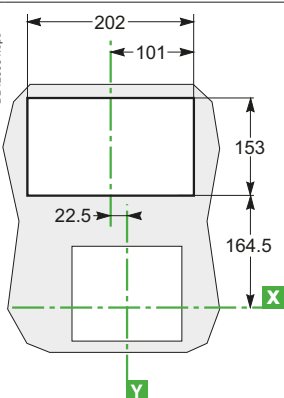
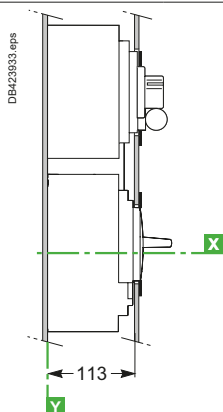
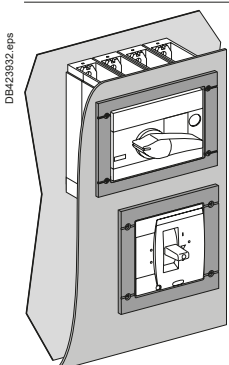

# ComPact NSX front-panel cutouts

Motor mechanism module for ComPact NSX100 to 630 with/without Vigi add-on

## Bare sheet metal

Fixed, plug-in or withdrawable circuit breaker

### NSX100 to 250

### NSX400/630

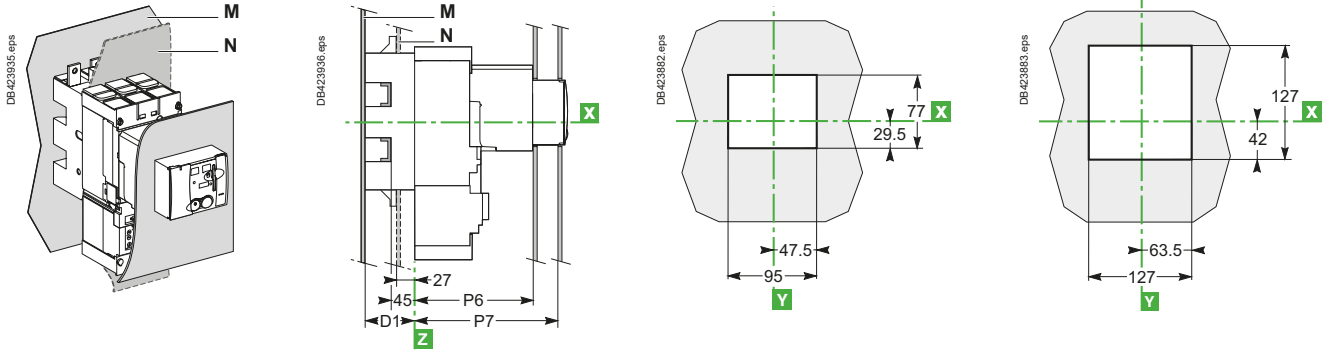

## With IP30 front-panel escutcheon

Fixed, plug-in or withdrawable circuit breaker

### NSX100 to 250

### NSX400/630

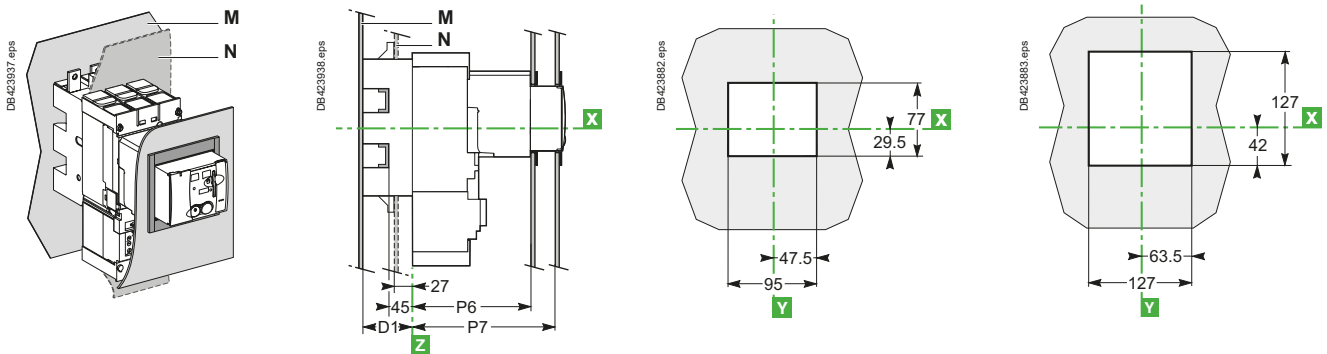

## With IP40 front-panel escutcheon

Fixed, plug-in or withdrawable circuit breaker without access to Vigi add-on

### NSX100 to 250

### NSX400/630

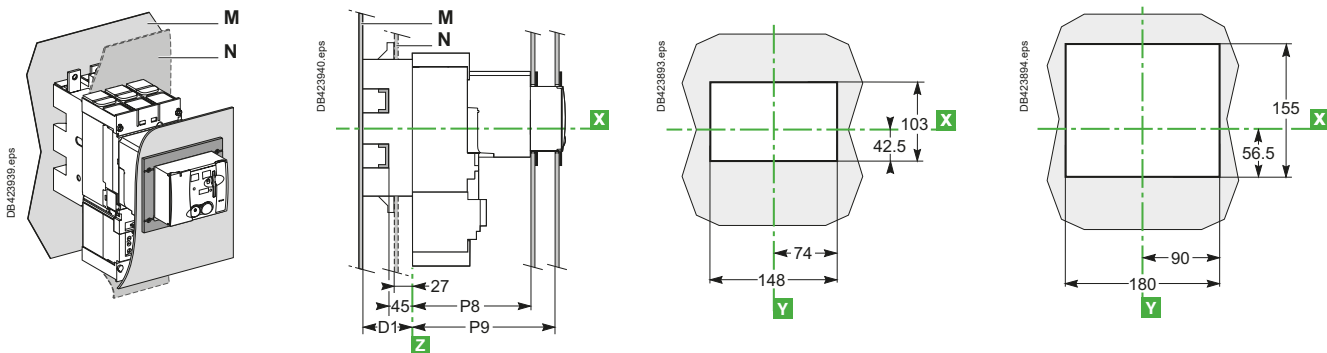

## Fixed or plug-in circuit breaker with access to Vigi add-on

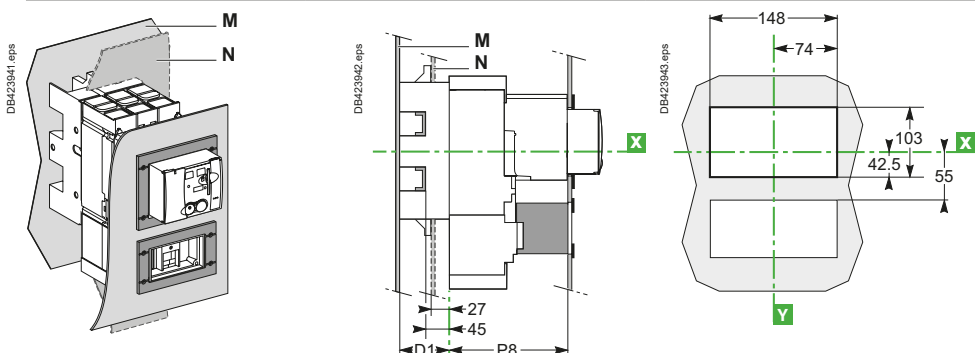

Type	D1	P6 [1]	P7 [2]	P8 [1]	P9 [2]
NSX100/160/250	75	145	177	146	178

[1] Plug-in version.

[2] Withdrawable version.

# Switchboard integration

## ComPact NSX front-panel cutouts

Direct rotary handle for ComPact NSX100 to 630 with/without Vigi add-on

### Fixed or plug-in circuit breakers

### NSX100 to 250

### NSX400/630

Bare sheet metal

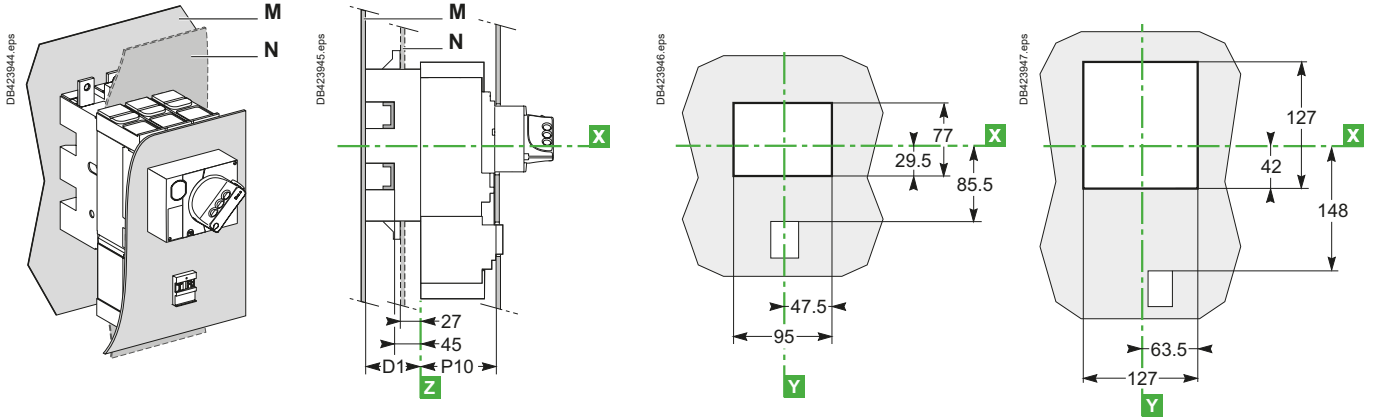

Bare sheet metal with access to the trip unit

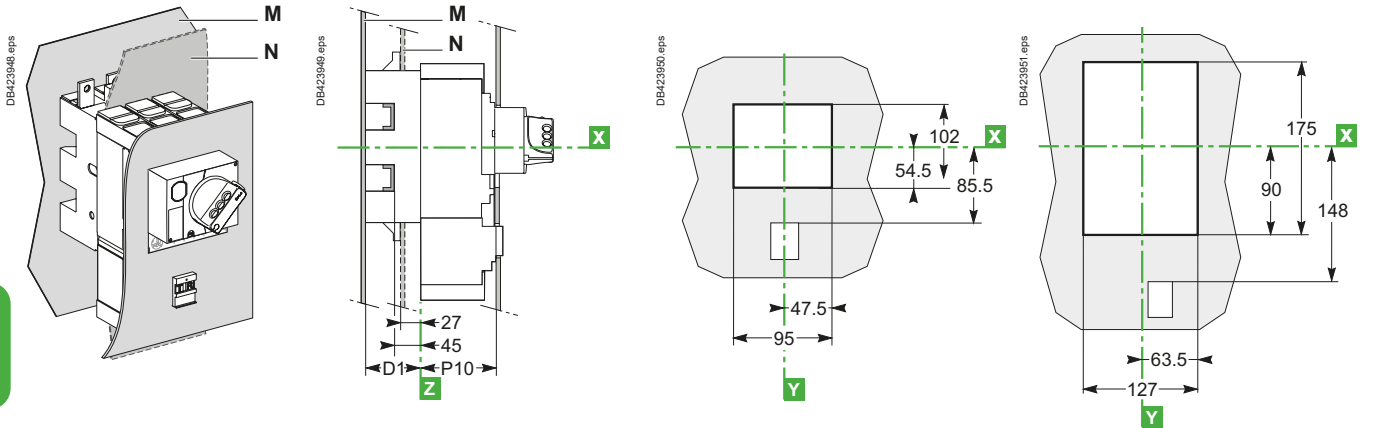

With IP30 front-panel escutcheon

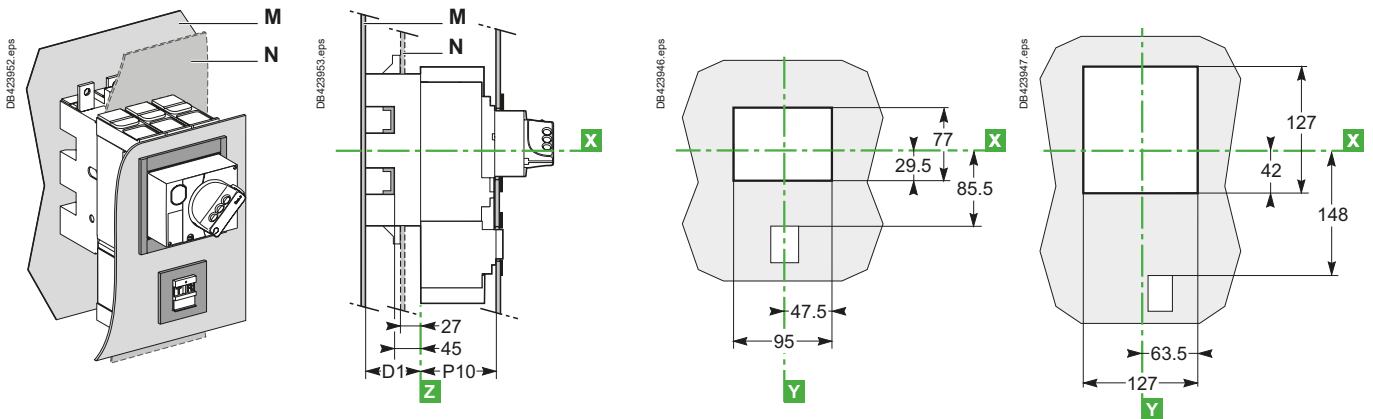

E

# ComPact NSX front-panel cutouts

Direct rotary handle for ComPact NSX100 to 630 with/without Vigi add-on

## Fixed or plug-in circuit breakers

### NSX100 to 250

### NSX400/630

With IP30 front-panel escutcheon with access to the trip unit

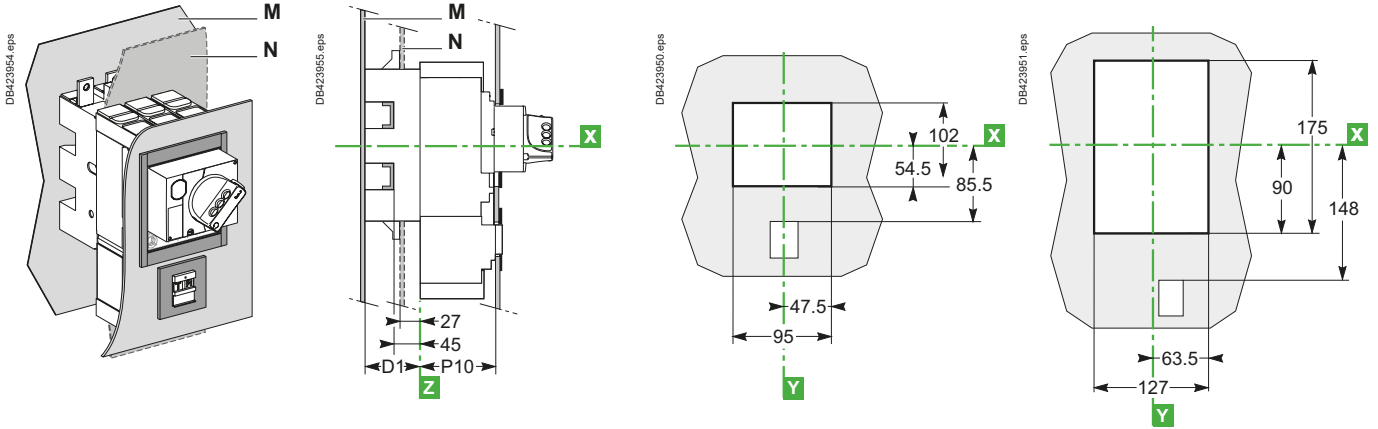

With IP40 front-panel escutcheon

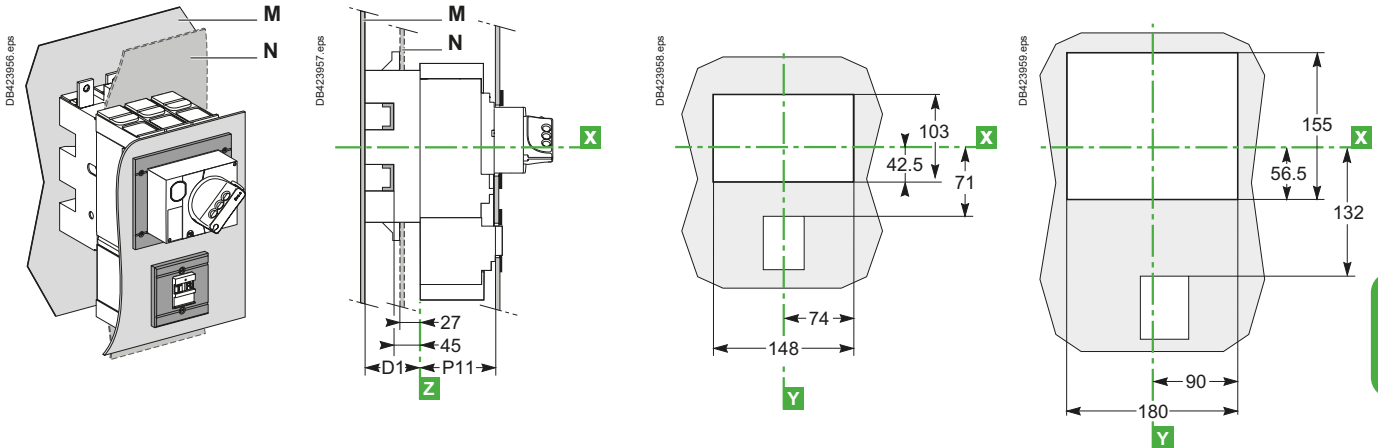

## Fixed or withdrawable circuit breakers

### NSX100 to 250

### NSX400/630

With IP40 front-panel escutcheon

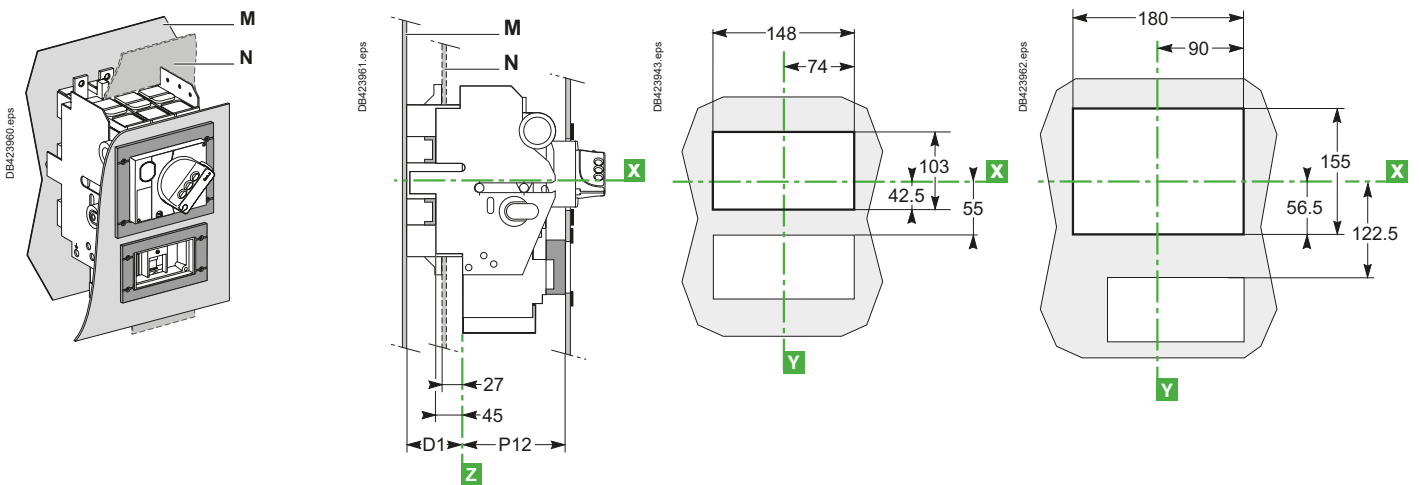

Type	D1	P10	P11	P12
NSX100/160/250	75	89	90	123
NSX400/630	100	112	113	147

# ComPact NSX front-panel cutouts

Indication and measurement modules for ComPact NSX100 to 630

## Fixed or plug-in circuit breakers with ammeter module and voltage-presence indicator

Bare sheet metal

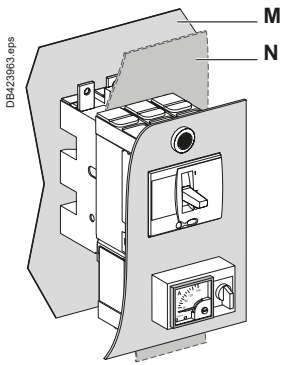

With toggle

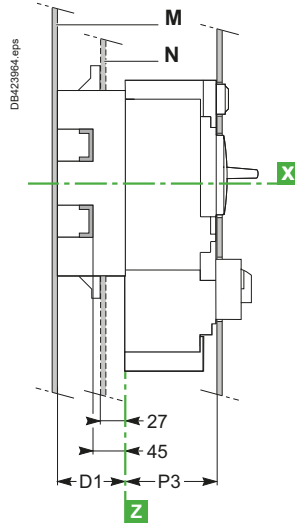

Rotary handle

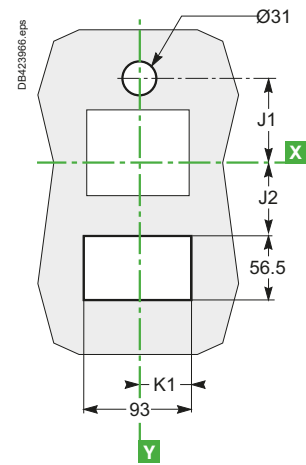
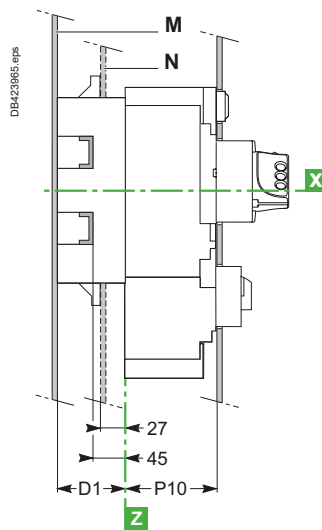

Type	D1	J1	J2	J3	K1	K2	P3	P4	P10	P11
NSX100/160/250	75	78.5	67.5	55	46.5	74	88	89	89	90
NSX400/630	100	122	129	122.5	64.5	90	112	113	112	113

# ComPact NSX front-panel cutouts

Indication and measurement modules for ComPact NSX100 to 630

## Fixed or plug-in circuit breakers with ammeter module and voltage-presence indicator With IP40 front-panel escutcheon

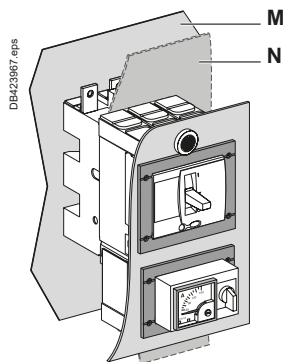

With toggle

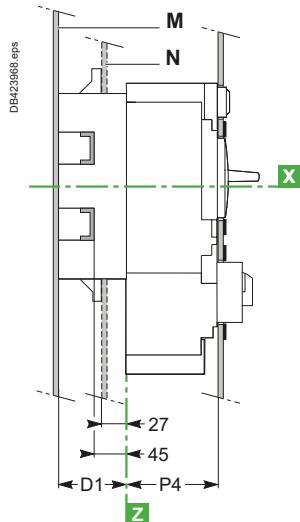

Rotary handle

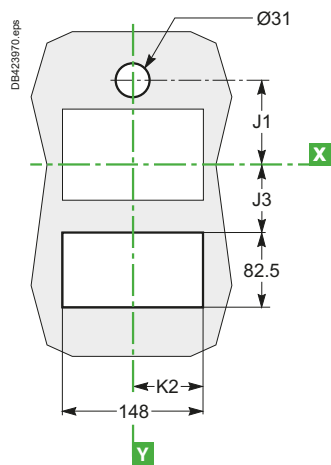
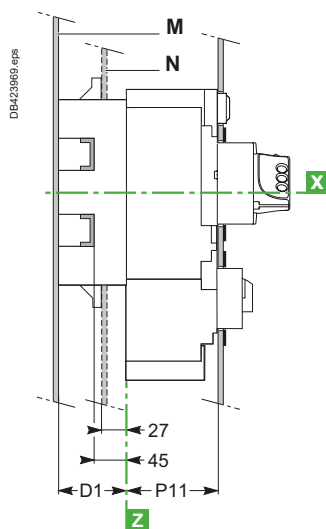

Type	D1	J1	J2	J3	K1	K2	P3	P4	P10	P11
NSX100/160/250	75	78.5	67.5	55	46.5	74	88	89	89	90
NSX400/630	100	122	129	122.5	64.5	90	112	113	112	113

# ComPact NSX power connections

ComPact NSX100 to 630 with/without Vigi add-on fixed version

## Connection locations

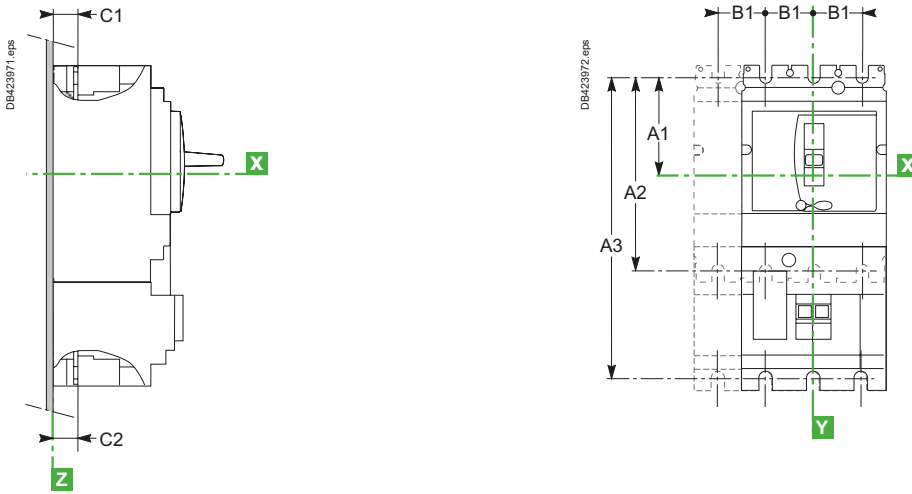

Type	A1	A2	B1	C1	C2
NSX100/160	70	140	35	19.5	19.5
NSX250	70	140	35	21.5	19.5
NSX400/630	113.5	227	45	26	26

Type	A1	A3	B1	C1	C2
NSX100/160 + Vigi	70	215	35	19.5	21.5
NSX250 + Vigi	70	215	35	21.5	21.5
NSX400/630 + Vigi	113.5	327	45	26	26

## Front connection without accessories

### NSX100 to 250

### NSX400/630

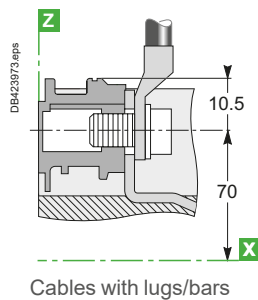
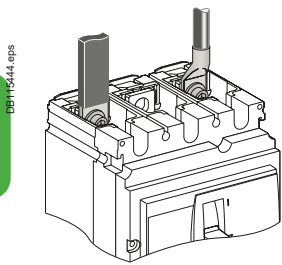

Cables with lugs/bars

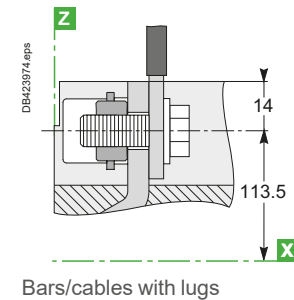

Bars/cables with lugs

## Connection with accessories

### Long and short rear connectors

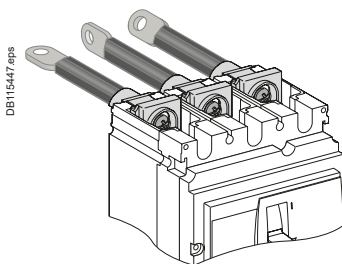

### NSX100 to 250

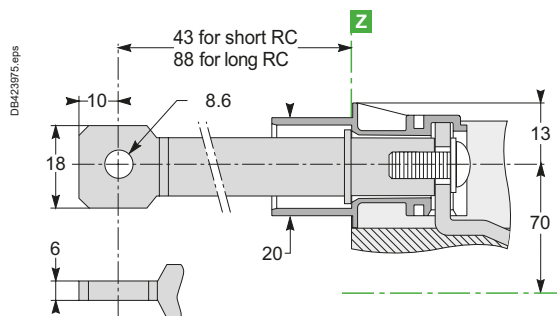

### NSX400/630

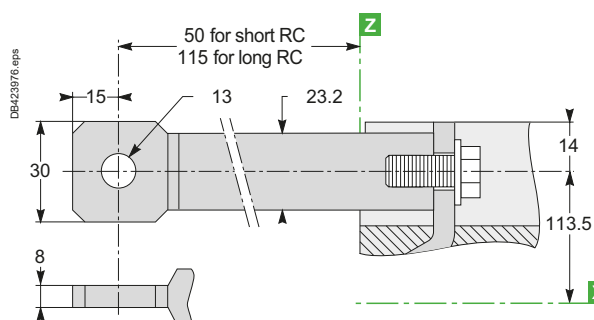



# ComPact NSX power connections

## ComPact NSX100 to 630 with/without Vigi add-on fixed version

### Connection with accessories

#### Bare-cable connectors

#### NSX100 to 250

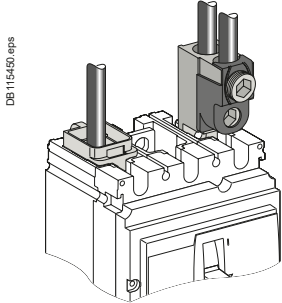

DB115430.eps

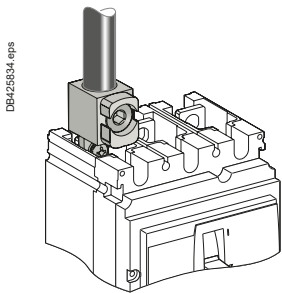
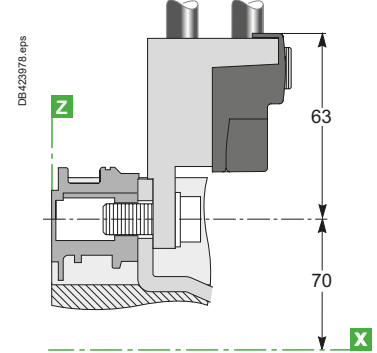
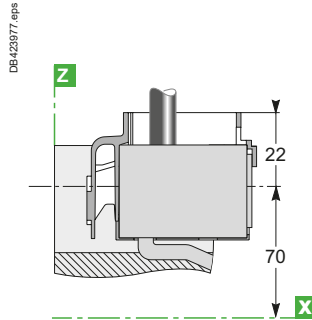

DB423954.eps

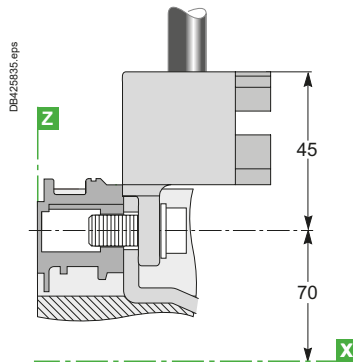

#### NSX400/630

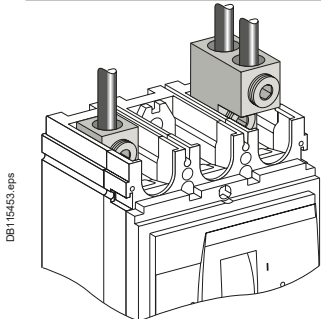

DB115453.eps

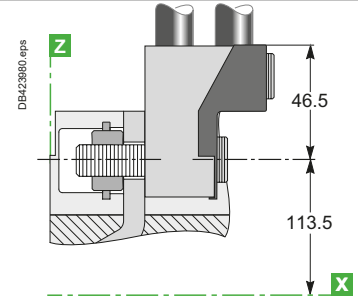
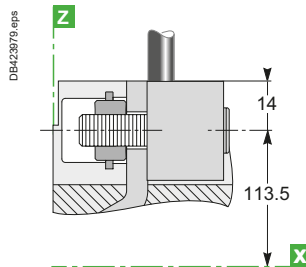

#### Distribution connectors (for NSX100 to 250 only)

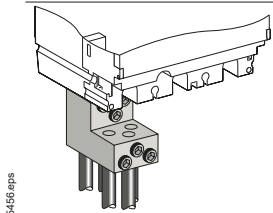

DB115456.eps

[a] Vigi add-on or NSX250.

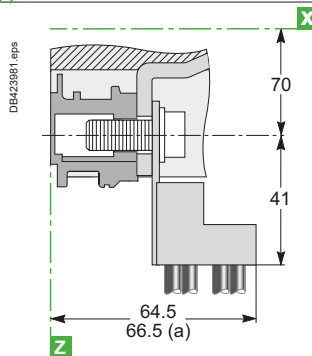

#### Right-angle terminal extensions (upstream only) NSX100 to 250

#### NSX400/630

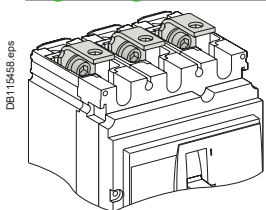

DB115465.eps

[b] NSX250.

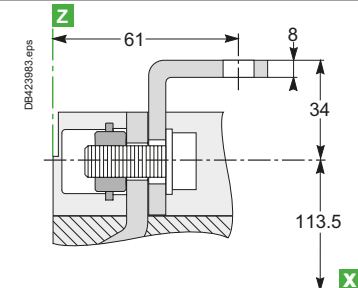
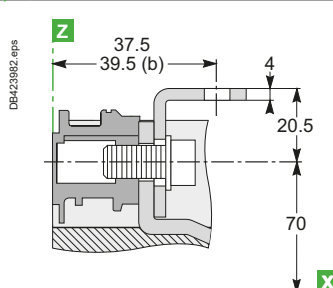

# ComPact NSX power connections

## ComPact NSX100 to 630 with/without Vigi add-on fixed version

### Connection with accessories

Straight terminal extensions (for NSX100 to 250 only)

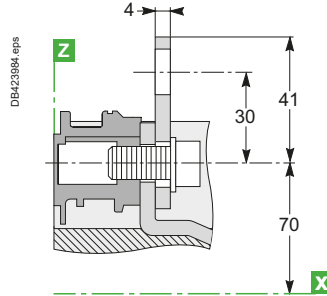
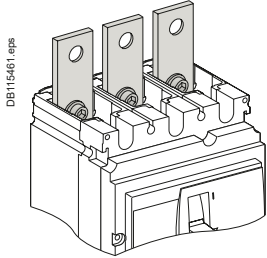

### Edgewise terminal extensions

NSX100 to 250

NSX400/630

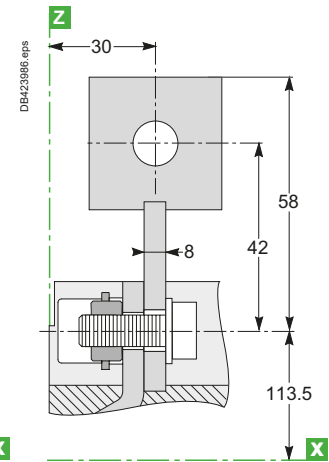
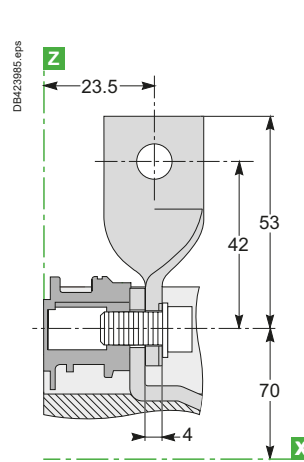
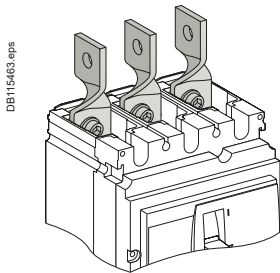

### 45° terminal extensions

NSX100 to 250

NSX400/630

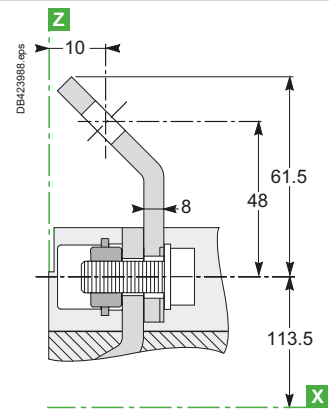
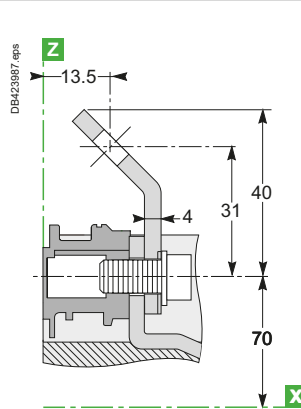
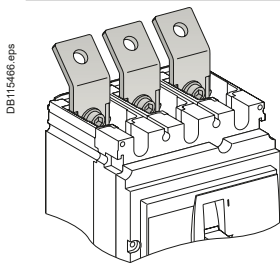

### Double-L terminal extensions

NSX100 to 250

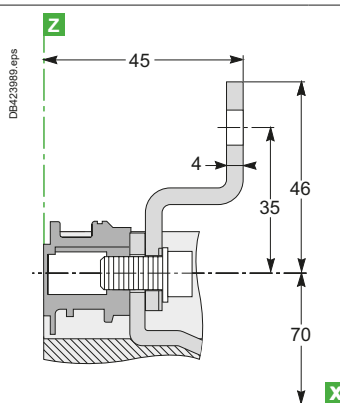
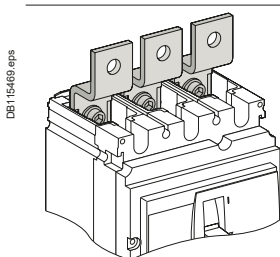

E

# ComPact NSX power connections

## ComPact NSX100 to 630 with/without Vigi add-on fixed version

### Connection with accessories

Spreaders

3P

4P

NSX100 to 250

NSX400/630

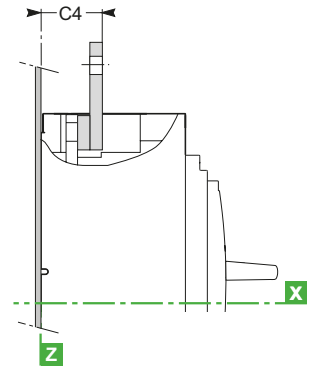
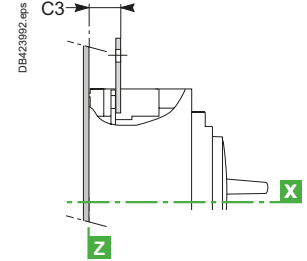
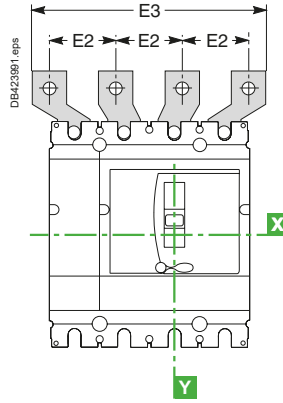
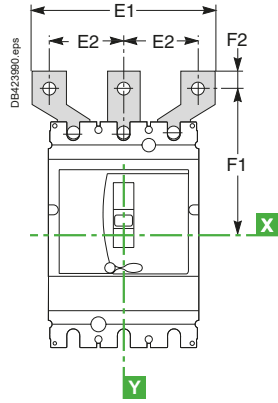
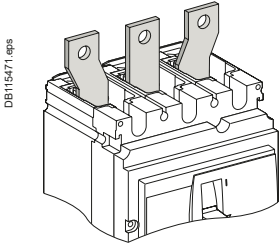

Type	C3	C4	E1	E2	E3	F1	F2
NSX100/160	23.5	-	114	45	159	100	11
NSX250	25.5	-	114	45	159	100	11
NSX400/630	-	44	135	52.5	187.5	152.5	15
			170	70	240	166	15

### One-piece spreader (for NSX100 to 250 only)

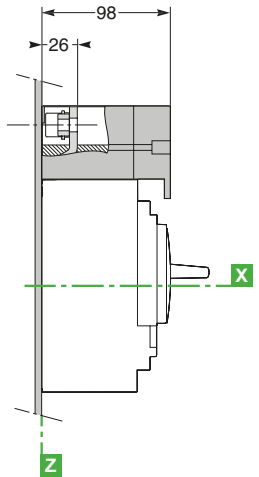
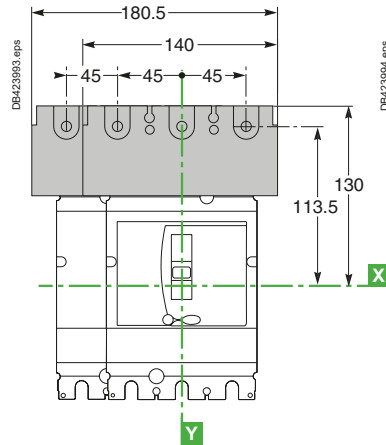
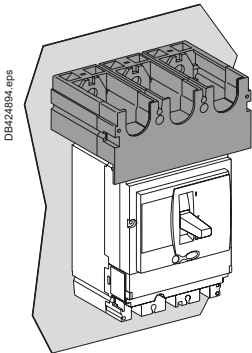

# Switchboard integration

## ComPact NSX power connections

ComPact NSX100 to 630 with/without Vigi add-on plug-in and withdrawable versions

### Connection locations

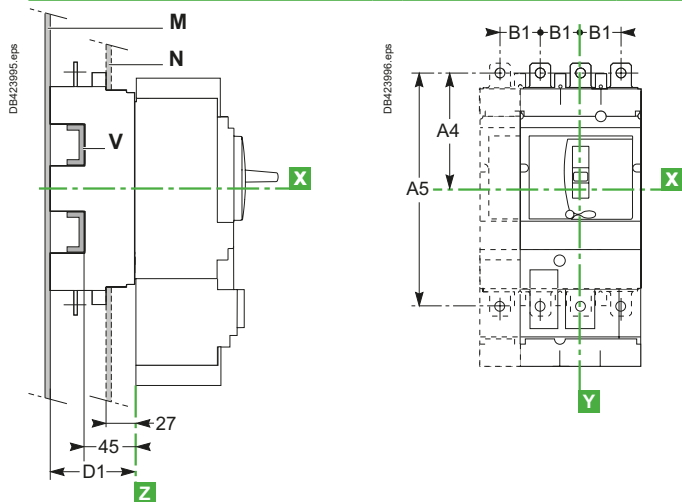

Type	A4	A5	B1	D1
NSX100 to 250	100	200	35	75
NSX400/630	156.5	313	45	100

**Note :**  
 ■ for mounting on a backplate, the insulating screen supplied with the plug-in base must be installed.  
 ■ for withdrawable versions, terminal shields are recommended.

### Connection without accessories

Front connection: mounting on backplate (M) or rails (V)

NSX100 to 250

NSX400/630

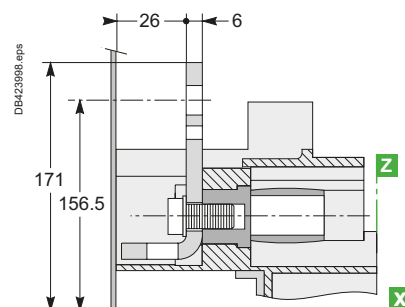
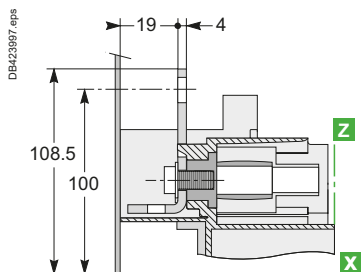
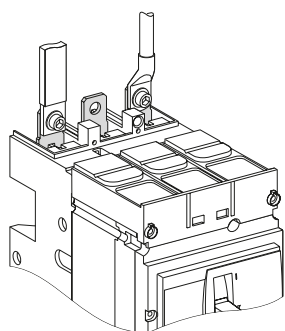

Rear connection: mounting through front panel (N) or on rails (V)

NSX100 to 250

NSX400/630

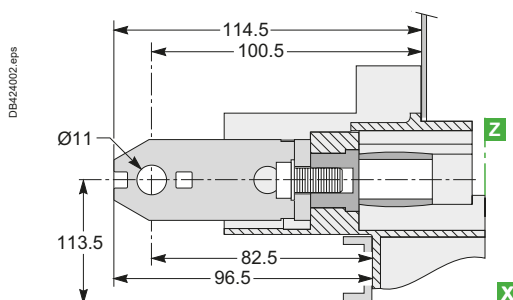
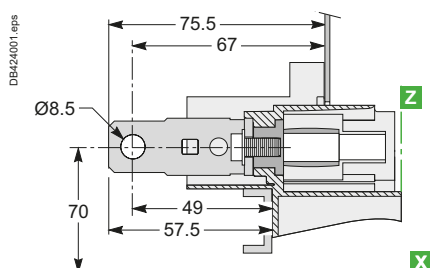
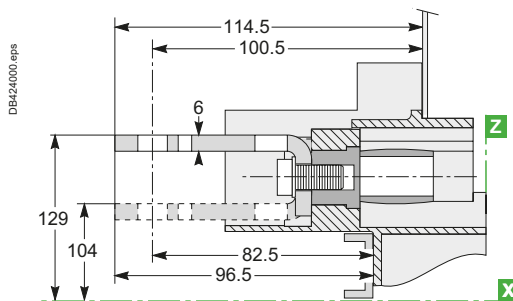
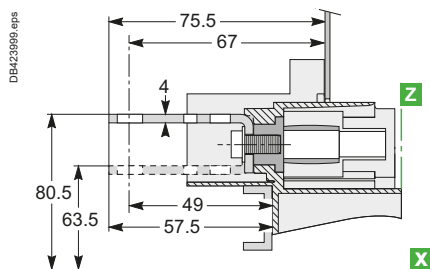
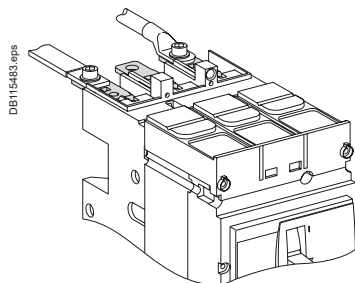

# ComPact NSX power connections

ComPact NSX100 to 630 with/without Vigi add-on plug-in and withdrawable versions

## Connection with accessories

Bare-cable connectors: mounting on backplate (M) or rails (V)

### NSX100 to 250

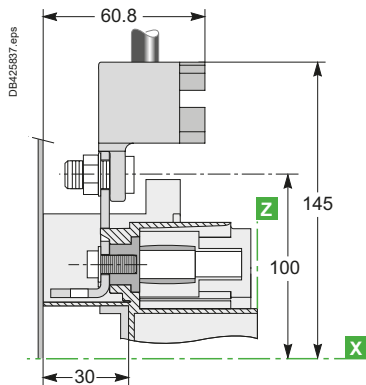
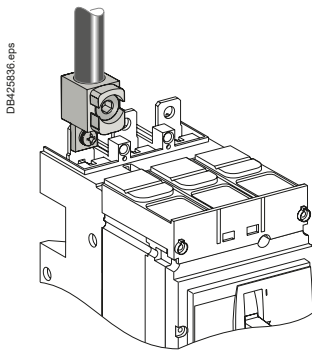
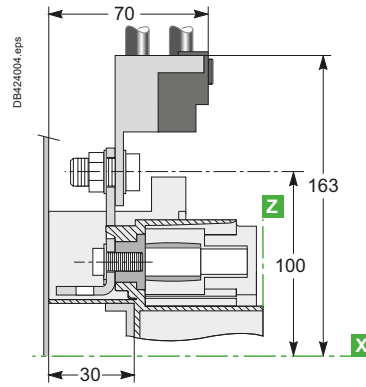
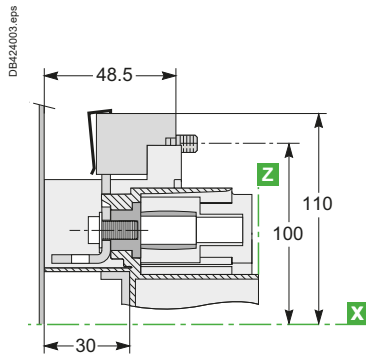
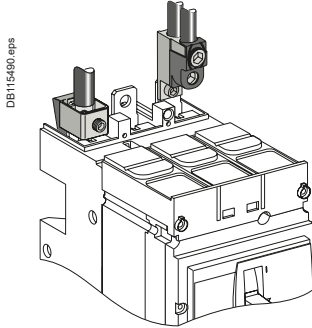

### NSX400/630

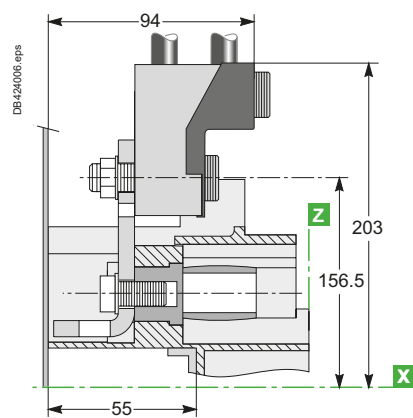
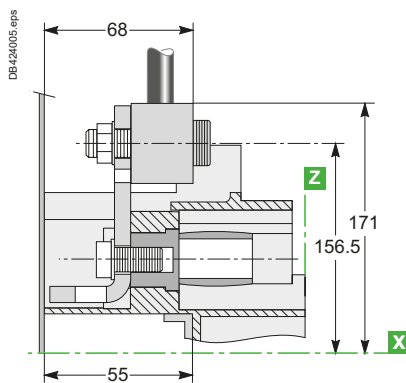
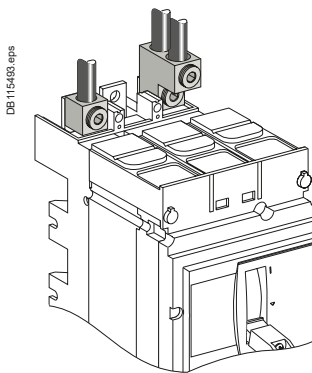

Bare-cable connectors: mounting through front panel (N) or on rails (V)

### NSX100 to 250

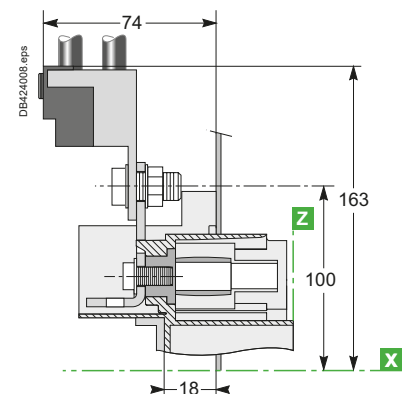
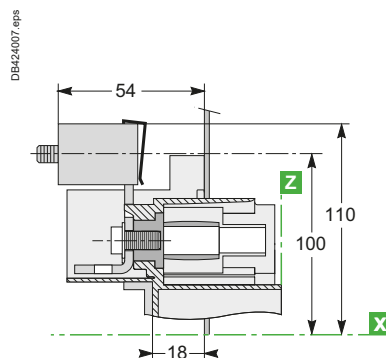
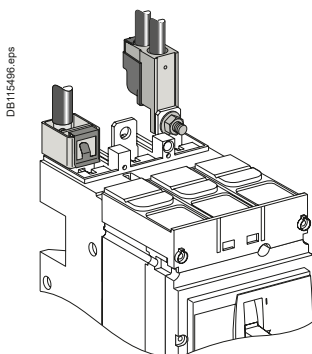

# ComPact NSX power connections

ComPact NSX100 to 630 with/without Vigi add-on plug-in and withdrawable versions

Bare-cable connectors: mounting through front panel (N) or on rails (V)

NSX400/630

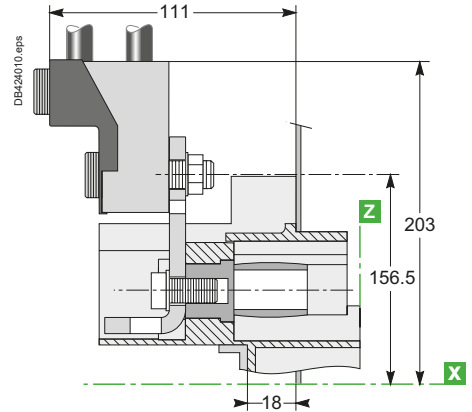
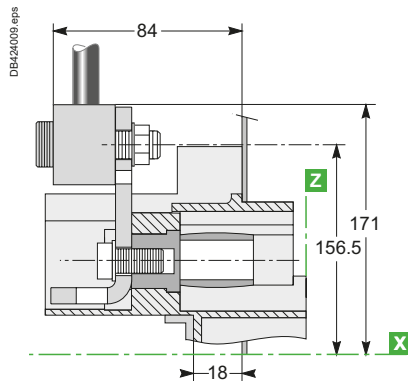
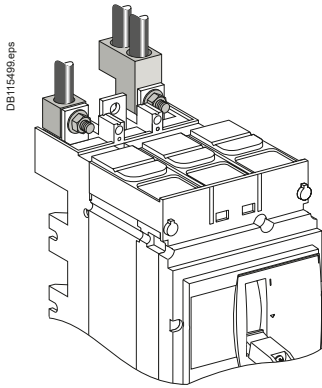

## Connection with accessories

45° extensions: mounting through front panel (N) or on rails (V)

NSX100 to 250

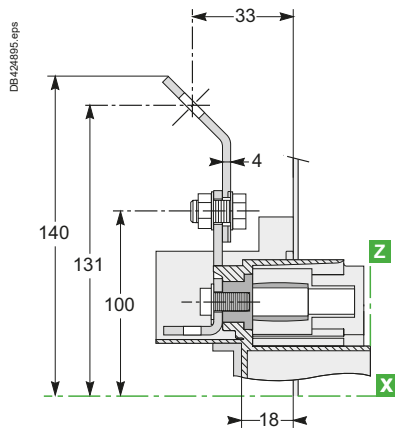
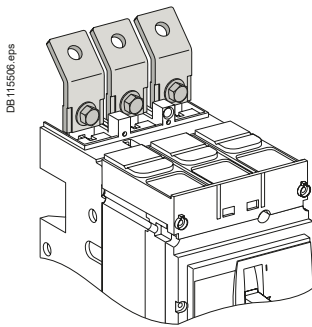

NSX400/630

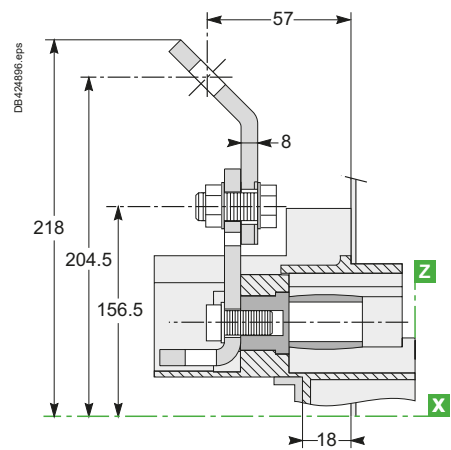

Double-L extensions: mounting on backplate (M) or rails (V)

NSX100 to 250

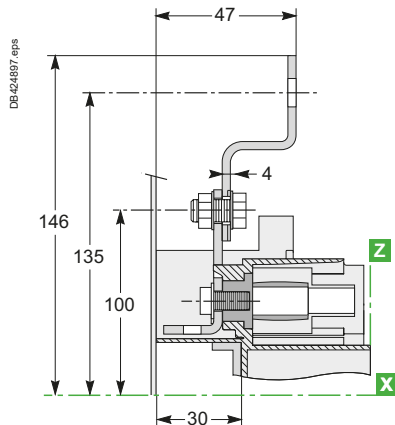
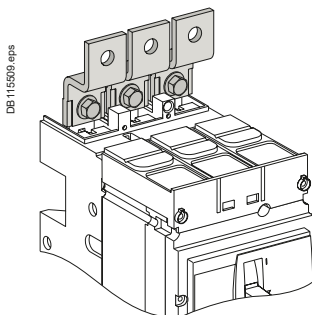

NSX100 to 250

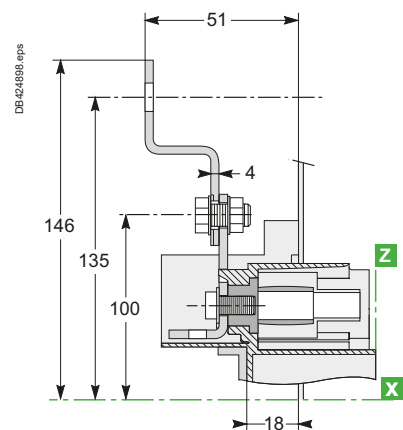

Double-L extensions: mounting through front panel (N) or on rails (V)

E

# ComPact NSX power connections

## ComPact NSX100 to 630 with/without Vigi add-on plug-in and withdrawable versions

### Connection with accessories

Spreaders: mounting on backplate (M) or rails (V)

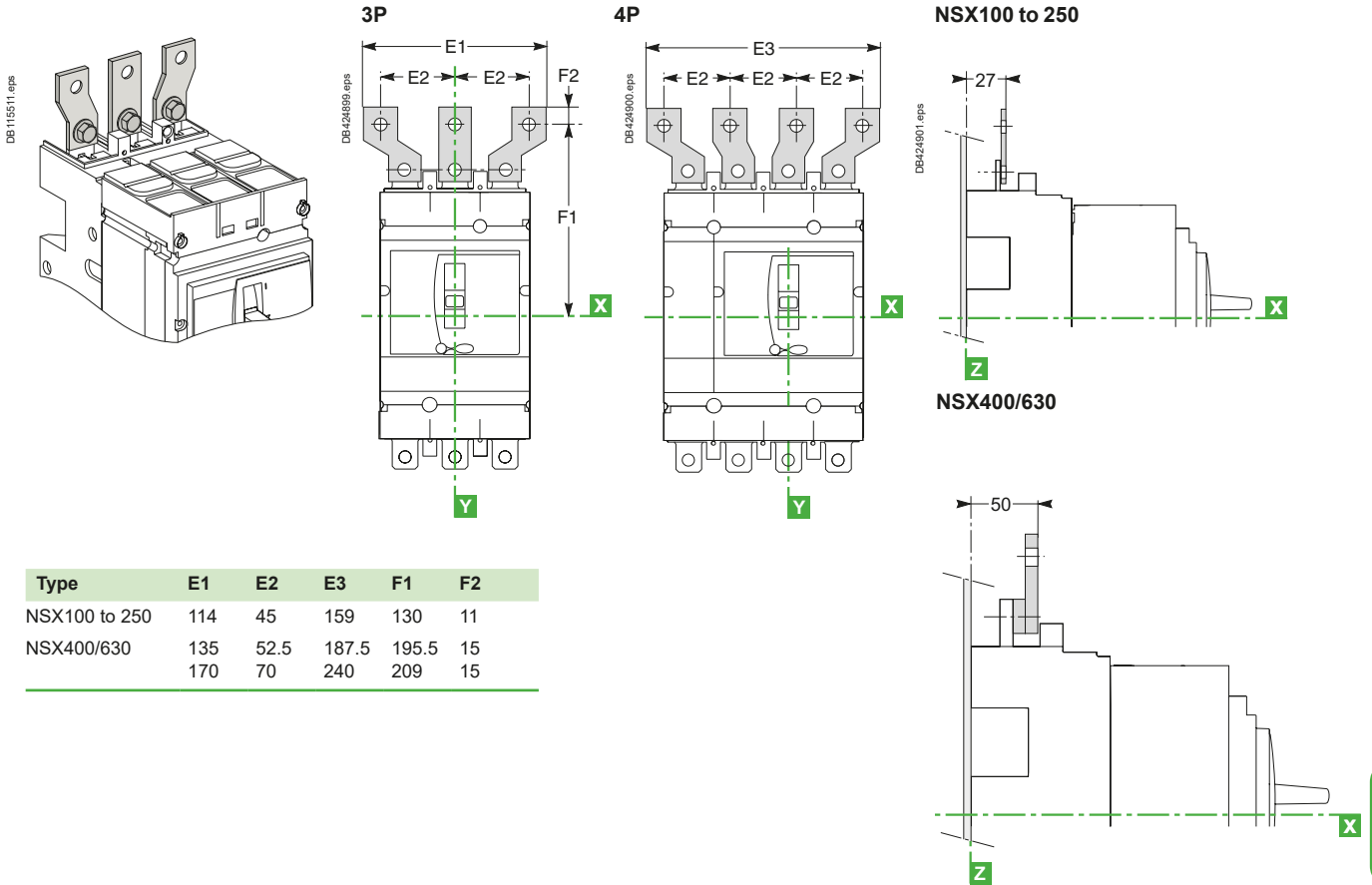

### Long insulated rear connectors: mounting on backplate (M) or rails (V)

Exterior-mounted rear connectors NSX100 to 250

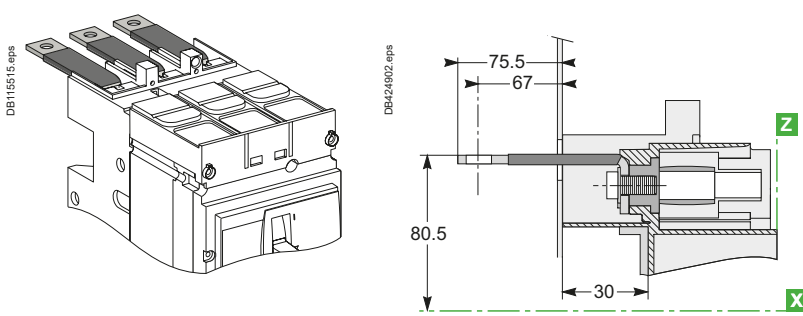

NSX400/630

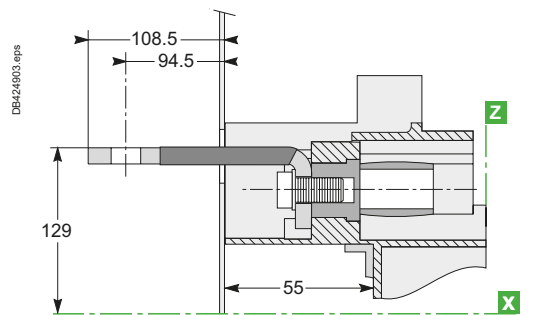

Interior-mounted rear connectors NSX100 to 250

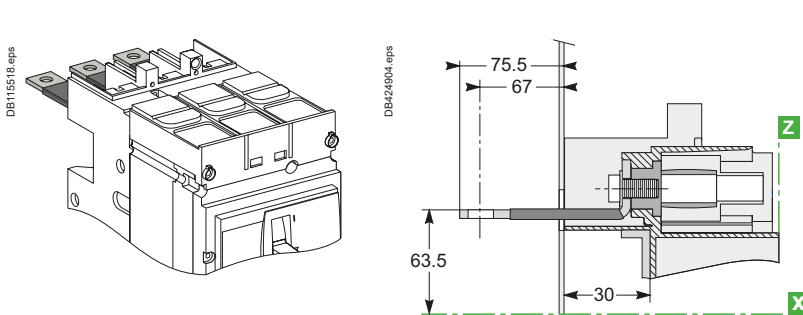

NSX400/630

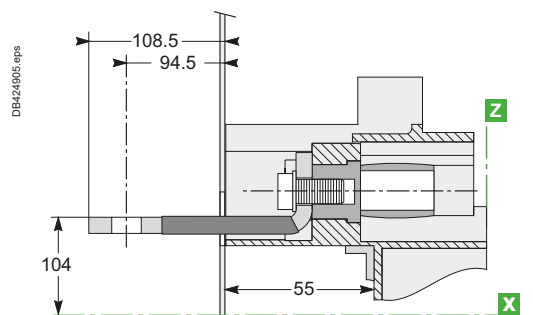

Long, insulated connectors are mandatory.

# Switchboard integration

## ComPact NSX power connections

Connection of insulated bars or cables with lugs to ComPact NSX100 to 630 with/without Vigi add-on

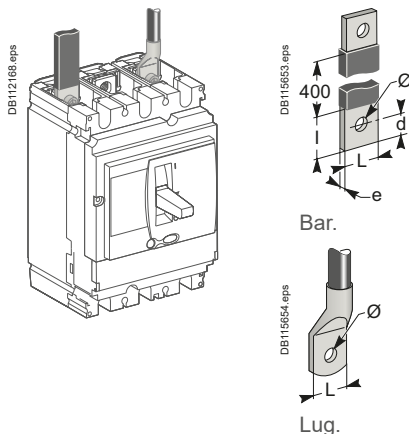

### Direct connection for NSX100 to 630

Dimensions		NSX100	NSX160/250	NSX400/630
<b>Bars</b>	L (mm)	≤ 25	≤ 25	≤ 32
	l (mm)	d + 10	d + 10	d + 15
	d (mm)	≤ 10	≤ 10	≤ 15
	e (mm)	≤ 6	≤ 6	3 ≤ e ≤ 10
	Ø (mm)	6.5	8.5	10.5
<b>Lugs</b>	L (mm)	≤ 25	≤ 25	≤ 32
	Ø (mm)	6.5	8.5	10.5
<b>Torque (Nm) [1]</b>		10	15	50
<b>Torque (Nm) [2]</b>		5/5	5/5	20/11
<b>Torque (Nm) [3]</b>		8	8	20

- [1] Tightening torque on the circuit breaker for lugs or bars.
- [2] Tightening torque on fixed devices for rear connectors//tightening torque on plug-in or withdrawable devices for power connectors.
- [3] Tightening torque on the plug-in base for terminal extensions.

### Accessories for NSX100 to 250

#### Straight terminal extensions

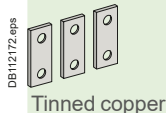

#### Double-L terminal extensions

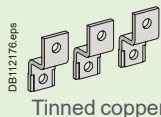

#### Spreaders: separate parts

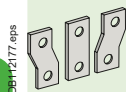

#### one-piece spreader

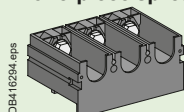

For U > 600 V, the mandatory insulation kit is not compatible with spreaders made up of separate parts. The one-piece spreader must be used.

### Connection with accessories for NSX100 to 250 (60228)

Pole pitch	
Without spreaders	35 mm
With spreaders	45 mm

Dimensions		NSX100	NSX160/250
------------	--	--------	------------

<b>Bars</b>	L (mm)	≤ 25	≤ 25
	l (mm)	20 ≤ l ≤ 25	20 ≤ l ≤ 25
	d (mm)	≤ 10	≤ 10
	e (mm)	≤ 6	≤ 6
	Ø (mm)	6.5	8.5
<b>Lugs</b>	L (mm)	≤ 25	≤ 25
	Ø (mm)	6.5	8.5
<b>Torque (Nm) [1]</b>		10	15
<b>Torque (Nm) [2]</b>		5	5

- [1] Tightening torque on the circuit breaker for spreaders or terminal extensions.
- [2] Tightening torque on the plug-in base for spreaders or terminal extensions.

Spreaders and straight, right-angle, 45°, double-L and edgewise terminal extensions are supplied with flexible interphase barriers.

### Accessories for NSX400 and 630

#### Spreaders made up of separate parts for 52.5 and 70 mm pitch

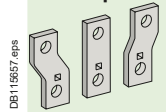

For U > 600 V, use of the 52.5 mm pitch spreaders requires a specific insulation kit. The 70 mm pitch spreaders may not be used.

### Connection with accessories for NSX400 and 630 (60228)

Pole pitch	
Without spreaders	45 mm
With spreaders	52.5 or 70 mm

Dimensions		With spreaders	With terminal extensions
------------	--	----------------	--------------------------

<b>Bars</b>	L (mm)	≤ 40	≤ 32
	l (mm)	d + 15	30 ≤ l ≤ 34
	d (mm)	≤ 20	≤ 15
	e (mm)	3 ≤ e ≤ 10	3 ≤ e ≤ 10
	Ø (mm)	12.5	10.5
<b>Lugs</b>	L (mm)	≤ 40	≤ 32
	Ø (mm)	12.5	10.5
<b>Torque (Nm) [1]</b>		50	50
<b>Torque (Nm) [2]</b>		20	20

- [1] Tightening torque on the circuit breaker for spreaders or terminal extensions.
- [2] Tightening torque on the plug-in base for spreaders or terminal extensions.

Spreaders and right-angle, 45° and edgewise terminal extensions are supplied with flexible interphase barriers.

### Accessories for NSX100 to 630

#### Right-angle terminal extensions

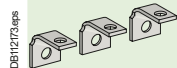

Tinned copper  
To be mounted on upstream side.

#### Edgewise terminal extensions



Tinned copper

#### 45° terminal extensions



Tinned copper

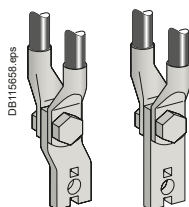

Mounting detail: 2 cables with lugs.



# ComPact NSX power connections

Connection of bare cables to ComPact NSX100 to 630 with/without Vigi add-on

## Connection for NSX100 to 250

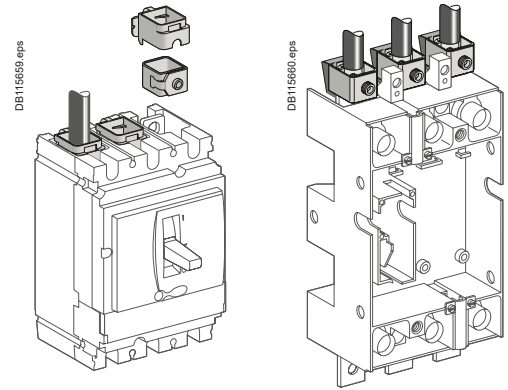
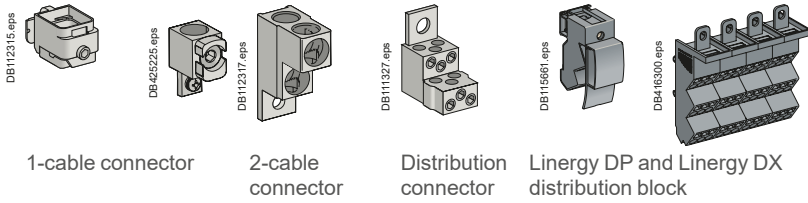

	1-cable connector	Steel ≤ 160 A	Aluminium ≤ 250 A		
L (mm)	25	25			
S (mm <sup>2</sup> ) Cu / Al	1.5 to 95 [1]	25 to 50	70 to 95	120 to 240	150 max. flex.
Torque (Nm)	12	20	26	31	
<b>2-cable connector</b>					
L (mm)	25 or 50				
S (mm <sup>2</sup> ) Cu / Al	2 x 50 to 2 x 120				
Torque (Nm)	22				
<b>6-cable distribution connector (copper or aluminium)</b>					
L (mm)	15 or 30				
S (mm <sup>2</sup> ) Cu / Al	1.5 to 6 [1]	8 to 35			
Torque (Nm)	4	6			
<b>Linergy DX and Linergy DP distribution block (6 or 9 cables)</b>					
L (mm)	12	16			
S (mm <sup>2</sup> ) Cu / Al	6 x 4 to 10	3 x 6 to 16			

[1] For flexible cables from 1.5 to 4 mm<sup>2</sup>, connection with crimped or self-crimping ferrules.

## Connection for NSX400 and 630

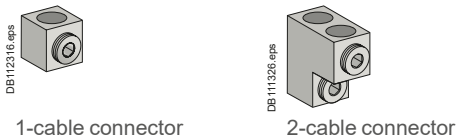

	1-cable connector	2-cable connector
L (mm)	30	30 or 60
S (mm <sup>2</sup> ) Cu / Al	35 to 300 rigid 240 max. flex.	2 x 35 to 2 x 240 rigid 240 max. flex.
Torque (Nm)	31	31

## Conductor materials and electrodynamic stresses

ComPact NSX circuit breakers can be connected indifferently with bare-copper, tinned-copper and tinned-aluminium conductors (flexible or rigid bars, cables). In the event of a short-circuit, thermal and electrodynamic stresses will be exerted on the conductors. They must therefore be correctly sized and held in place by supports.

Electrical connection points on switchgear devices (switch-disconnectors, contactors, circuit breakers, etc.) should not be used for mechanical support. Any partition between upstream and downstream connections of the device must be made of non-magnetic material.



# Switchboard integration

## ComPact NSXm

### Auxiliaries

The diagram is shown with circuits de-energized, relays in normal position, and all devices open, connected, and charged. Terminal connections shown as **O** must be connected by the customer.

#### Indication contacts

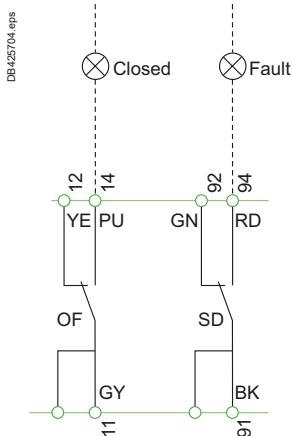

#### Indication contacts

- OF** Device ON/OFF indication contacts
- SD** Trip indication contact

#### Color code for auxiliary wiring

- BK:** Black
- GN:** Green
- GY:** Grey
- RD:** Red
- PU:** Purple
- YE:** Yellow

#### Remote operation

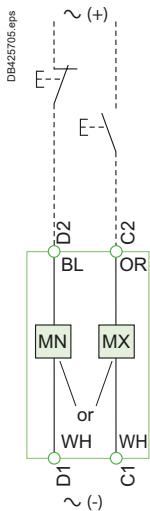

#### Remote operation

- MN** Undervoltage Release
- or
- MX** Shunt trip Release

#### Color code for auxiliary wiring

- BL:** Blue
- OR:** Orange
- WH:** White

E

# Switchboard integration ComPact NSXm SDx module for MicroLogic Vigi 4.1 (ELCB)

The diagram is shown with circuits de-energised, all devices open, connected and charged and relays in normal position.

## Connection

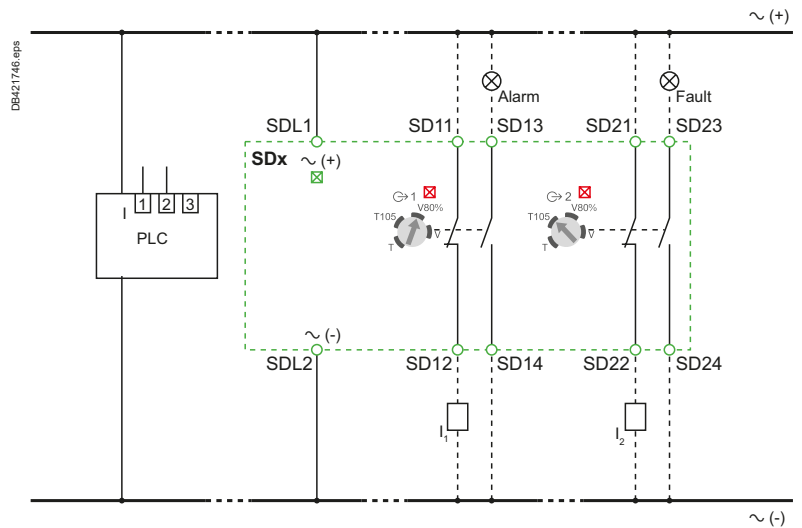

## Operation

- I: charge current
- SDT105: overload alarm
- SDT: overload trip indication
- $I_{\Delta n}$ : earth leakage current
- SDV80: earth leakage alarm
- SDV: earth leakage trip indication
- Q: circuit breaker

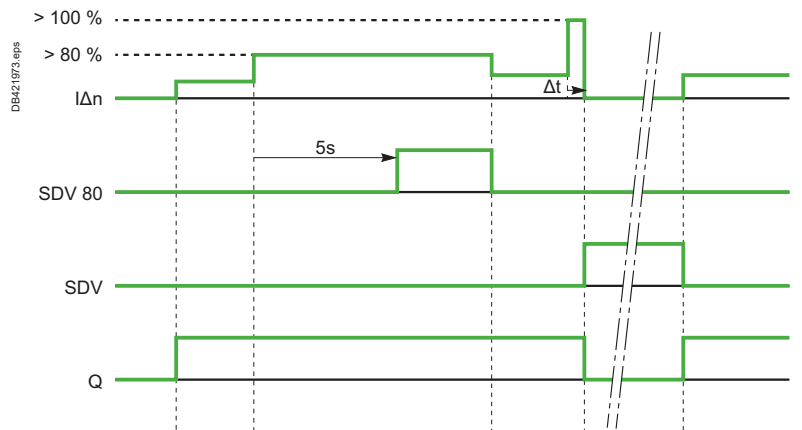
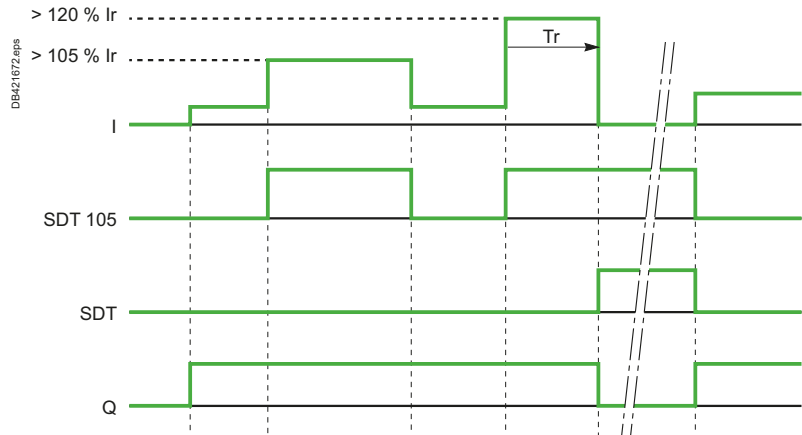

# Switchboard integration

## ComPact NSXm

### Communication

#### Connection of circuit breakers to the Modbus communication network

DB452551 eps

E

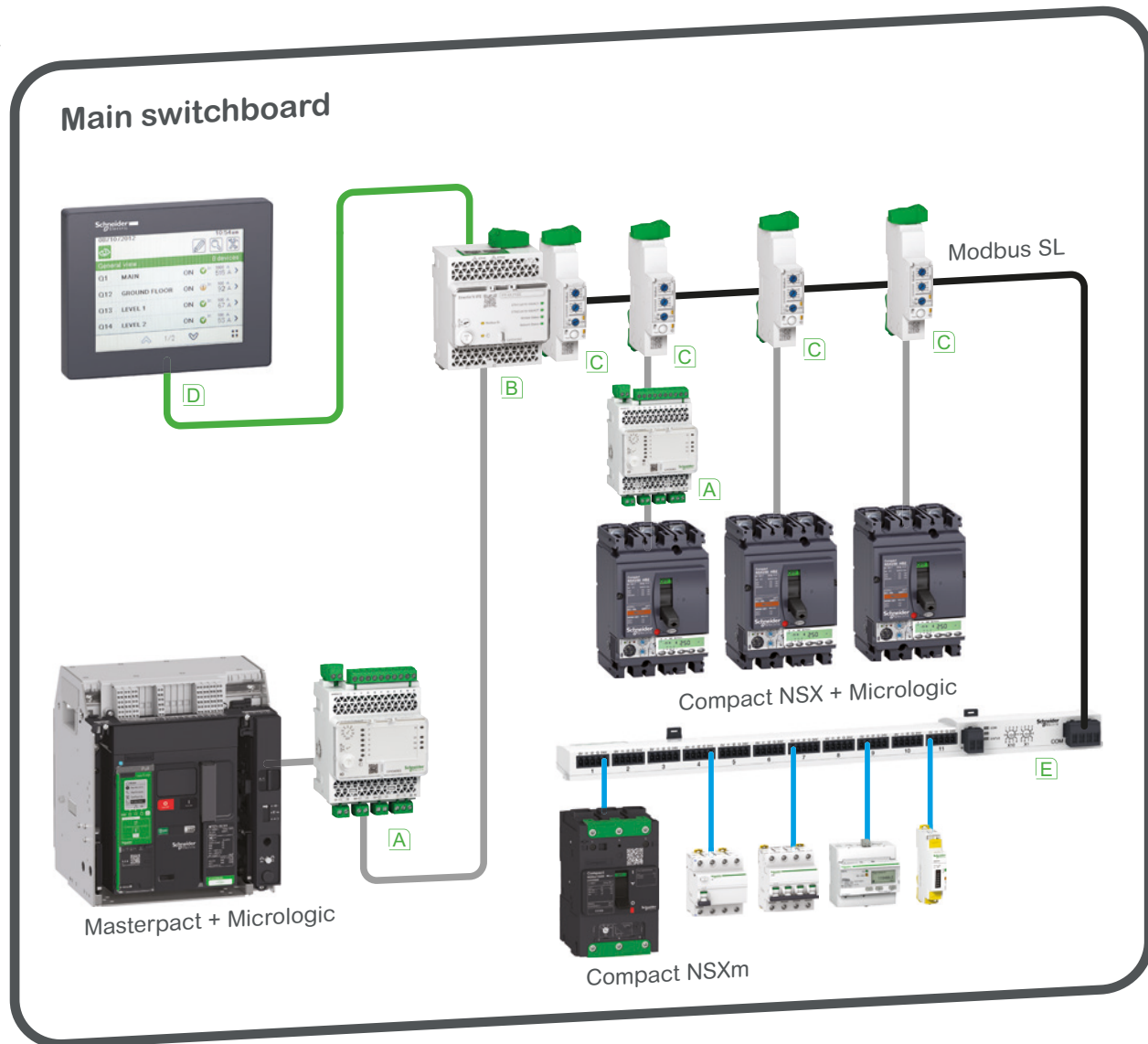

**A** I/O

**B** IFE interface + gateway

**C** IFM

**D** FDM128

**E** Acti9 Smartlink Modbus

— Ethernet

— Modbus SL

— ULP

— Hard wired

# Switchboard integration

## ComPact NSX

### Fixed circuit breakers

#### Power

#### MicroLogic

#### Remote operation

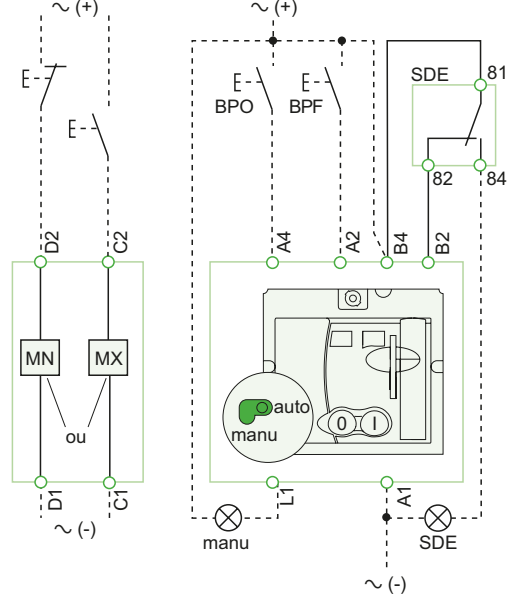
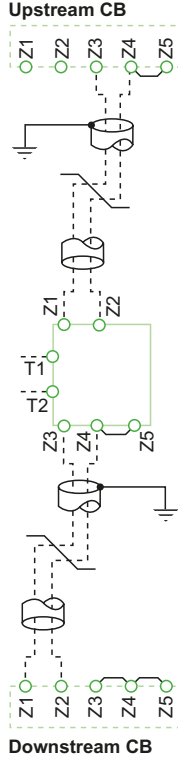
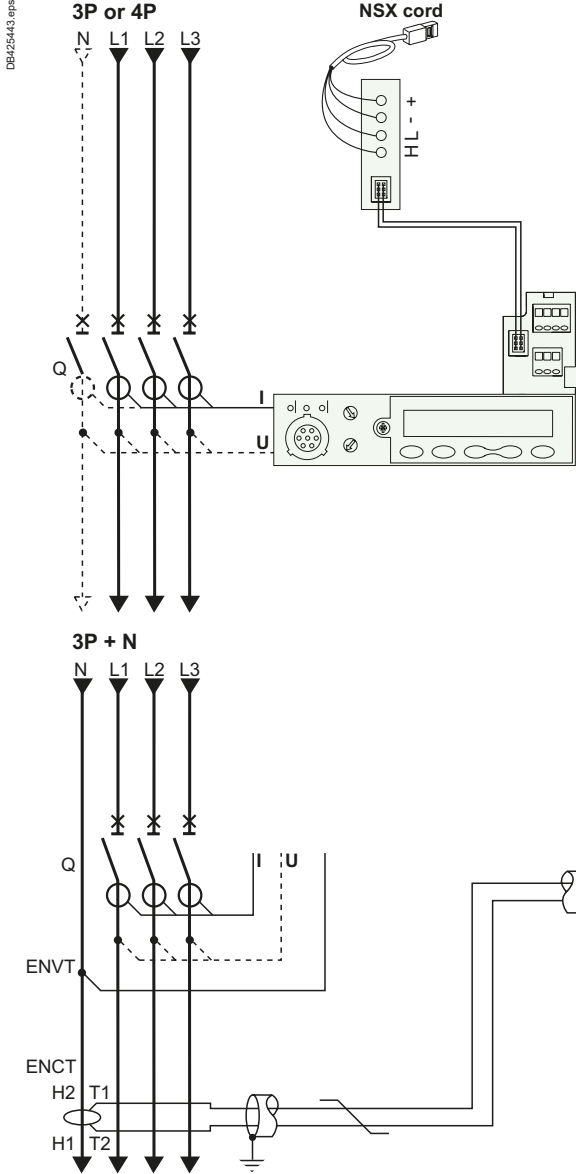

#### Motor mechanism (MT)

#### NSX cord

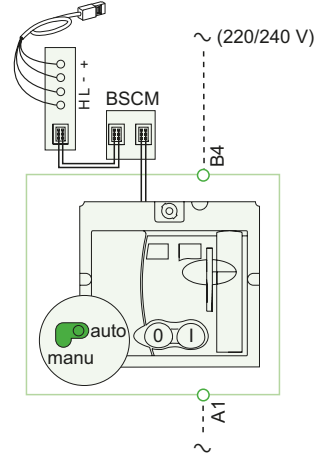

#### Communicating motor mechanism (MTC)

#### MicroLogic A or E

**A/E Communication**  
 H(WH), L(BL): data  
 - (BK), + (RD): 24 V DC power supply

**A/E ZSI (Zone Selective Interlocking)**  
 Z1: ZSI OUT SOURCE  
 Z2: ZSI OUT  
 Z3: ZSI IN SOURCE  
 Z4: ZSI IN ST (short time)  
 Z5: ZSI IN GF (ground fault)  
**Note:** Z3, Z4, Z5 for NSX400/630 only.

**A/E ENCT:** external neutral current transformer:  
 - shielded cable with 1 twisted pair (T1, T2)  
 - shielding earthed at one end only (CT end).  
 Connection L = 30 cm max.  
 - maximum length of 10 metres  
 - cable size 0.4 to 1.5 mm<sup>2</sup>  
 - recommended cable: Belden 8441 or equivalent.

**E ENVT:** external neutral voltage tap for connection to the neutral via a 3P circuit breaker.

#### Remote operation

**MN:** undervoltage release  
**or**  
**MX:** shunt release

#### Motor mechanism (MT)

**A4:** opening order  
**A2:** closing order  
**B4, A1:** power supply to motor mechanism  
**L1:** manual position (manu)  
**B2:** SDE interlocking (mandatory for correct operation)

**BPO:** opening pushbutton  
**BPF:** closing pushbutton

#### Communicating motor mechanism (MTC)

**B4, A1:** motor mechanism power supply  
**BSCM:** breaker status and control module



# Switchboard integration

## ComPact NSX

### Fixed circuit breakers

#### Indication contacts

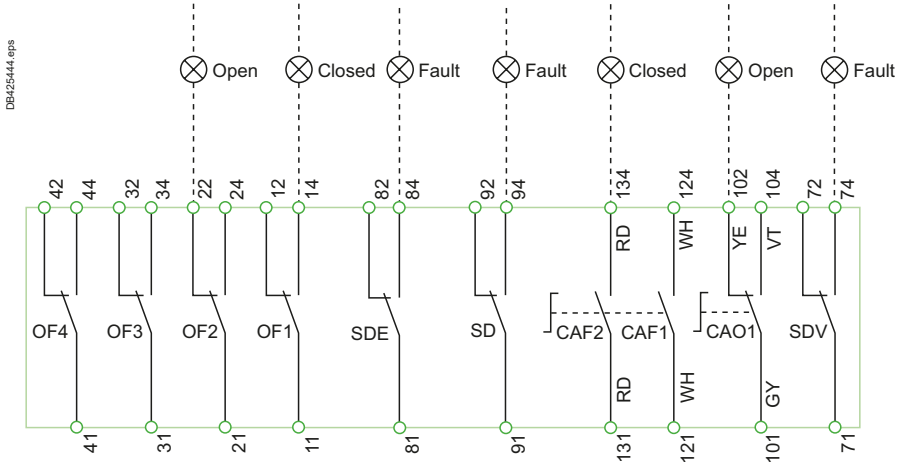

E

The diagram is shown with circuits de-energised, all devices open, connected and charged and relays in normal position. Terminals shown in green ● must be connected by the customer.

#### Indication contacts

- OF2 / OF1:** device ON/OFF indication contacts
- OF4 / OF3:** device ON/OFF indication contacts (NSX400/630)
- SDE:** fault-trip indication contact (short-circuit, overload, ground fault, earth leakage)
- SD:** trip-indication contact
- CAF2/CAF1:** early-make contact (rotary handle only)
- CAO1:** early-break contact (rotary handle only)
- SDV:** earth leakage fault trip indication contact (Vigi add-on)

#### Colour code for auxiliary wiring

- |                   |                   |
|-------------------|-------------------|
| <b>RD:</b> red    | <b>VT:</b> violet |
| <b>WH:</b> white  | <b>GY:</b> grey   |
| <b>YE:</b> yellow | <b>OR:</b> orange |
| <b>BK:</b> black  | <b>BL:</b> blue   |
| <b>GN:</b> green  |                   |

#### Power

#### MicroLogic

#### Remote operation

DB425445.eps

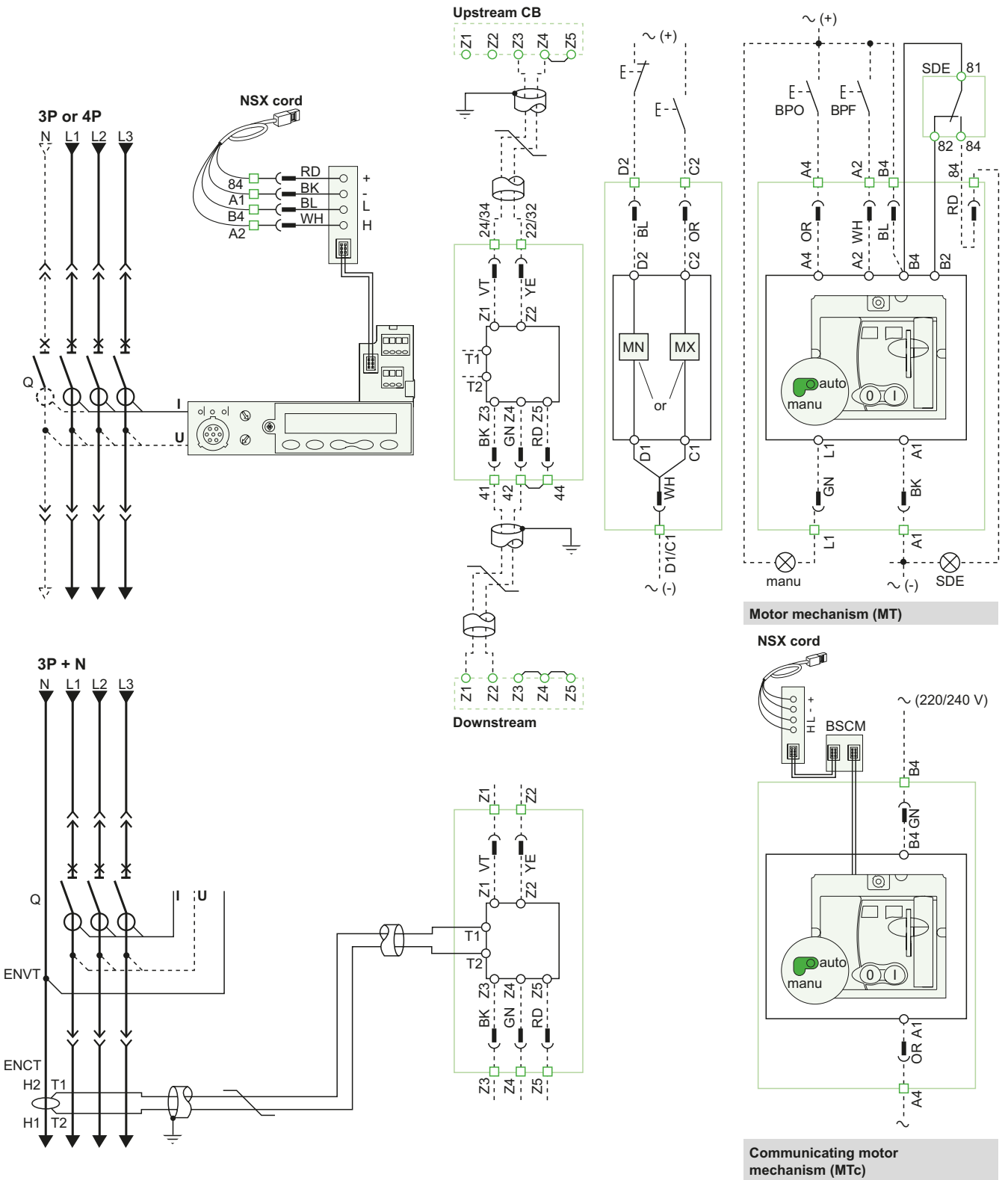

The diagram is shown with circuits de-energised, all devices open, connected and charged and relays in normal position.

# ComPact NSX

## Plug-in / withdrawable circuit breakers

### Indication contacts

### Carriage switches

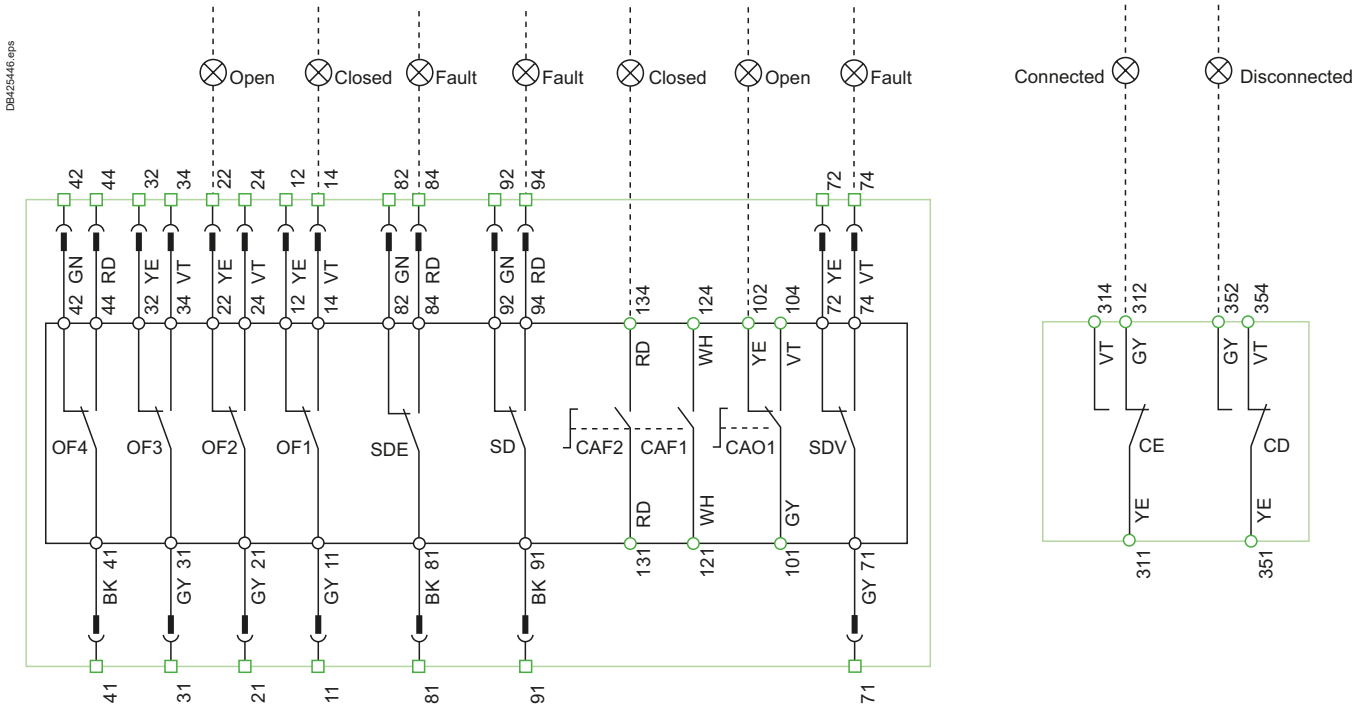

E

#### MicroLogic A or E

##### A/E Communication

H(WH), L(BL): data  
- (BK), + (RD): 24 V DC power supply

##### A/E ZSI (Zone Selective Interlocking)

Z1: ZSI OUT SOURCE  
Z2: ZSI OUT  
Z3: ZSI IN SOURCE  
Z4: ZSI IN ST (short time)  
Z5: ZSI IN GF (ground fault)

**Note:** Z3, Z4, Z5 for NSX400/630 only.

##### A/E ENCT: external neutral current transformer:

- shielded cable with 1 twisted pair (T1, T2)
- shielding earthed at one end only (CT end).

Connection L = 30 cm max.  
- maximum length of 10 metres  
- cable size 0.4 to 1.5 mm<sup>2</sup>  
- recommended cable: Belden 8441 or equivalent.

##### E ENVT: external neutral voltage tap for connection to the neutral via a 3P circuit breaker.

#### Colour code for auxiliary wiring

<b>RD:</b> red	<b>VT:</b> violet
<b>WH:</b> white	<b>GY:</b> grey
<b>YE:</b> yellow	<b>OR:</b> orange
<b>BK:</b> black	<b>BL:</b> blue
<b>GN:</b> green	

Terminals shown in green □ / ○ must be connected by the customer.

#### Remote operation

**MN:** undervoltage release

or

**MX:** shunt release

#### Motor mechanism (MT)

**A4:** opening order

**A2:** closing order

**B4, A1:** motor mechanism power supply

**L1:** manual position (manu)

**B2:** SDE interlocking (mandatory for automatic or remote recharging)

**BPO:** opening pushbutton

**BPF:** closing pushbutton

#### Communicating motor mechanism (MTc)

**B4, A1:** motor mechanism power supply

**BSCM:** breaker status and control module

#### Indication contacts

**OF2 / OF1:** device ON/OFF indication contacts

**OF4 / OF3:** device ON/OFF indication contacts (NSX400/630)

**SDE:** fault-trip indication contact

(short-circuit, overload, ground fault, earth leakage)

**SD:** trip-indication contact

**CAF2/CAF1:** early-make contact (rotary handle only)

**CAO1:** early-break contact (rotary handle only)

**SDV:** earth leakage fault trip indication contact (Vigi add-on)



The diagram is shown with circuits de-energised, all devices open, connected and charged and relays in normal position.

After tripping initiated by the "Push to trip" button or by the undervoltage (MN) release or the shunt (MX) release, device reset can be automatic, remote or manual.

Following tripping due to an electrical fault (with an SDE contact), reset must be carried out manually.

#### Motor mechanism (MT) with automatic reset

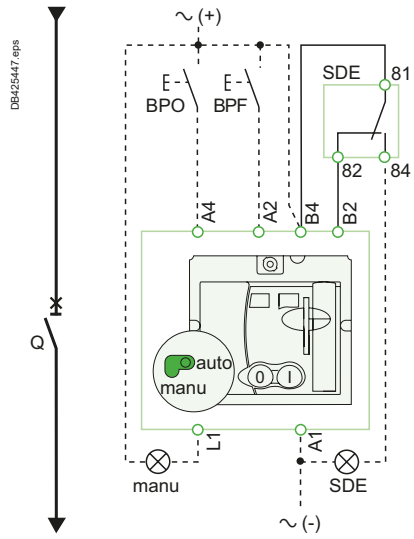

#### Motor mechanism (MT) with remote reset

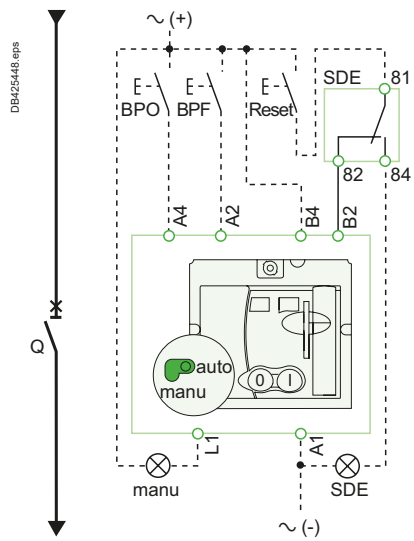

#### Motor mechanism (MT) with manual reset

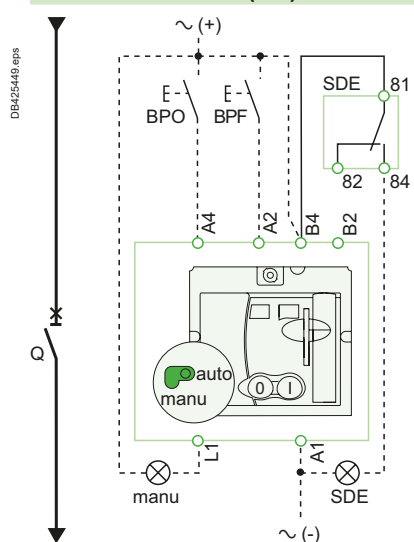

#### Symbols

- Q:** circuit breaker
- A4 :** opening order
- A2:** closing order
- B4, A1:** motor mechanism power supply
- L1:** manual position (manu)
- B2:** SDE interlocking (mandatory for correct operation)
- BPO:** opening pushbutton
- BPF:** closing pushbutton
- SDE:** fault-trip indication contact (short-circuit, overload, ground fault, earth leakage)



**Communicating motor mechanism (MTc)**

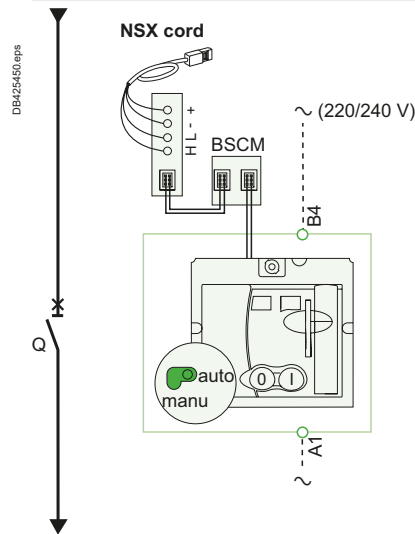

Schematic representation of the communicating motor mechanism (MT).

**Single-line diagram of communicating motor mechanism**

Opening, closing and reset orders are transmitted via the communication network. The "Enable automatic reset" and "Enable reset even if SDE" parameters must be set using the EcoStruxure Power Commission software via the screen by clicking the blue text.

"Auto/manu" is a switch on the front of the motor mechanism.

**Symbols**

- Q:** circuit breaker
- B4, A1:** motor mechanism power supply
- BSCM:** breaker status and control module

Terminals shown in green ○ must be connected by the customer.

# Switchboard integration ComPact NSX SDx module with MicroLogic

The diagram is shown with circuits de-energised, all devices open, connected and charged and relays in normal position.

### Connection

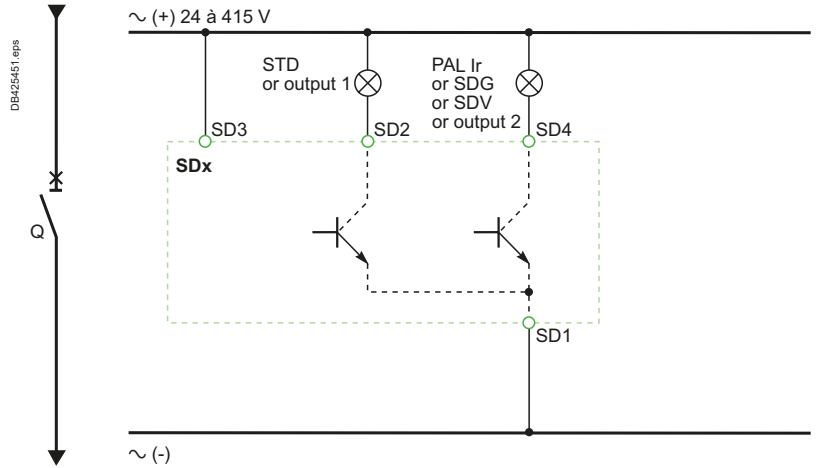

### Symbols

- SD1, SD3:** SDx-module power supply
- SD2:** output 1 (80 mA max.)
- SD4:** output 2 (80 mA max.)

	SD2	SD4
<b>MicroLogic 2</b>	SDT	-
<b>MicroLogic Vigi 4</b>	SDT	SDV
<b>MicroLogic 5</b>	SDT or output 1	PAL Ir or output 2
<b>MicroLogic 6</b>	SDT or output 1	SDG or output 2
<b>MicroLogic Vigi 7</b>	SDT or output 1	SDV or output 2

Terminals shown in green **O** must be connected by the customer.

### Operation

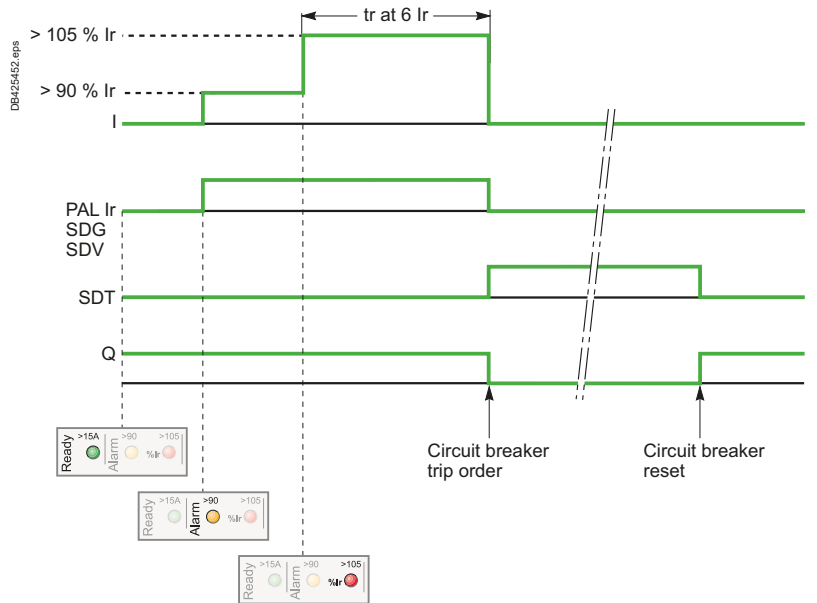

- I:** charge current
- PAL Ir:** thermal overload pre-alarm
- SDG:** ground-fault signal
- SDT:** thermal-fault signal
- SDV:** residual current trip signal
- Q:** circuit breaker



# ComPact NSX

## SDTAM module with MicroLogic M

The diagram is shown with circuits de-energised, all devices open, connected and charged and relays in normal position.

### Symbols

- SD1, SD3:** SDTAM-module power supply
- SD2:** thermal-fault signal output (80 mA max.)
- SD4:** contactor-control output (80 mA max.)

	SD2	SD4
<b>MicroLogic 2-M</b>	SDT	KA1
<b>MicroLogic 6 E-M</b>	SDT	KA1

Terminals shown in green ○ must be connected by the customer.

### Connection

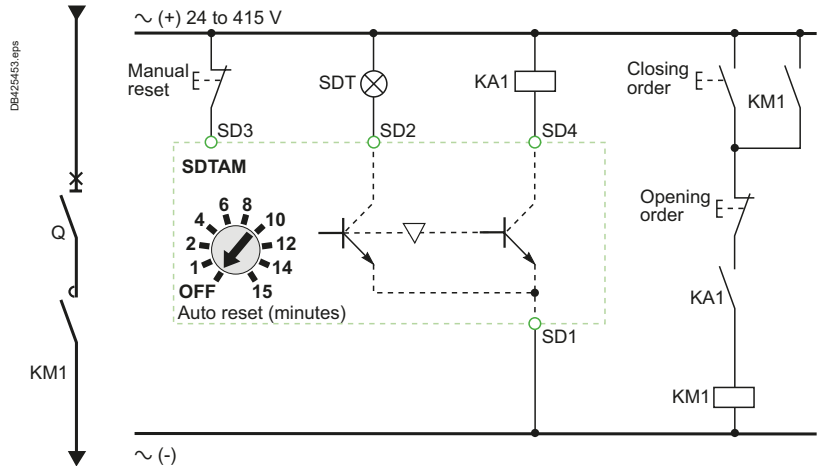

### Operation

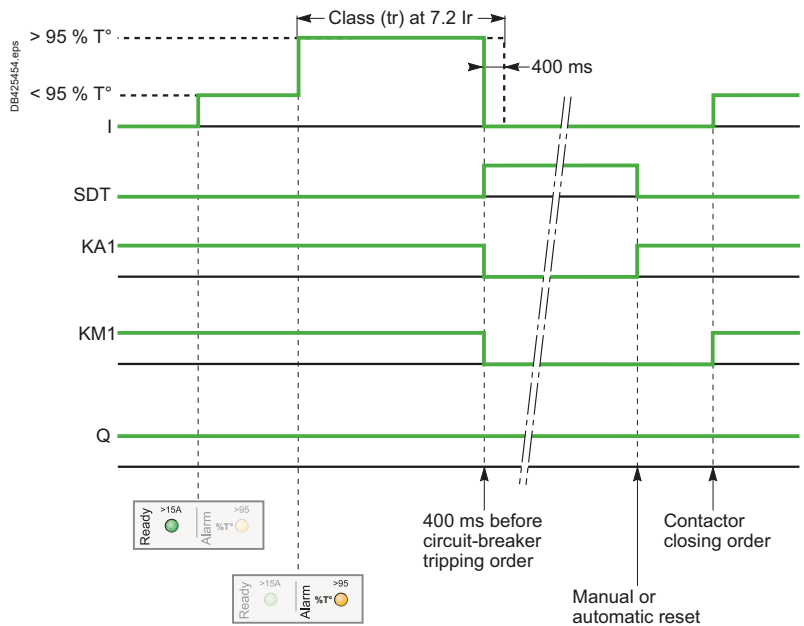

- I:** charge current
- SDT:** thermal-fault signal
- KA1:** auxiliary relay (e.g. RBN or RTBT relay)
- KM1:** motor contactor
- Q:** circuit breaker

# Switchboard integration ComPact NSX Communication

## Connection of circuit breakers to the Modbus communication network

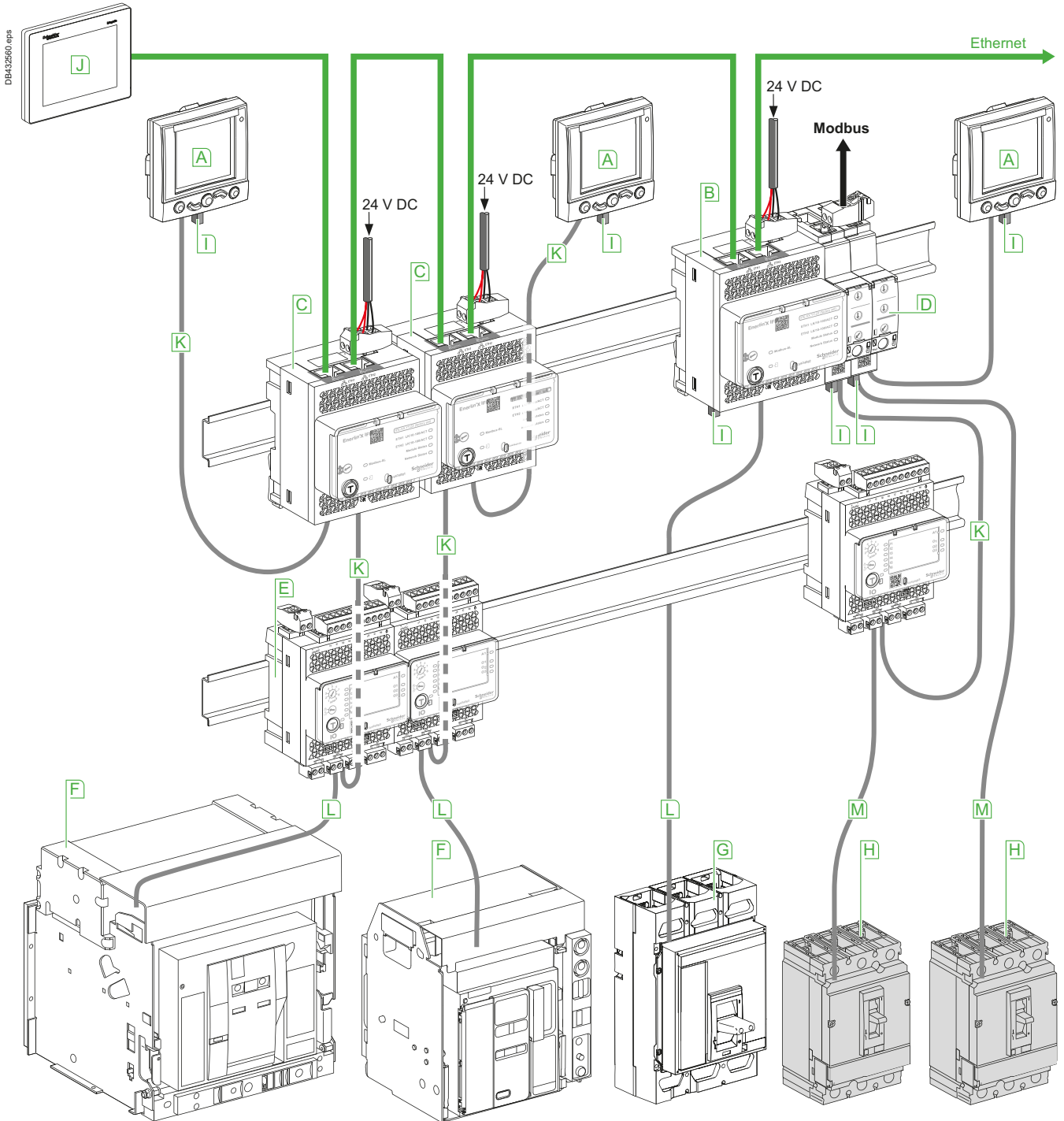

- A** FDM121 (TRV00121)
- B** IFE interface (LV434002)
- C** IFE switchboard server (LV434001)
- D** IFM (LV484000)
- E** I/O application module (LV434063)
- F** MasterPact MTZ
- G** ComPact NS630b-3200
- H** ComPact NSX
- I** ULP termination (TRV00880)
- J** FDM128 (LV434128)

- K** ULP cable
- L** Breaker ULP cord
- M** NSX cord
- Ethernet
- Modbus



# Switchboard integration

## ComPact NSX

### Communication

DE43262.eps

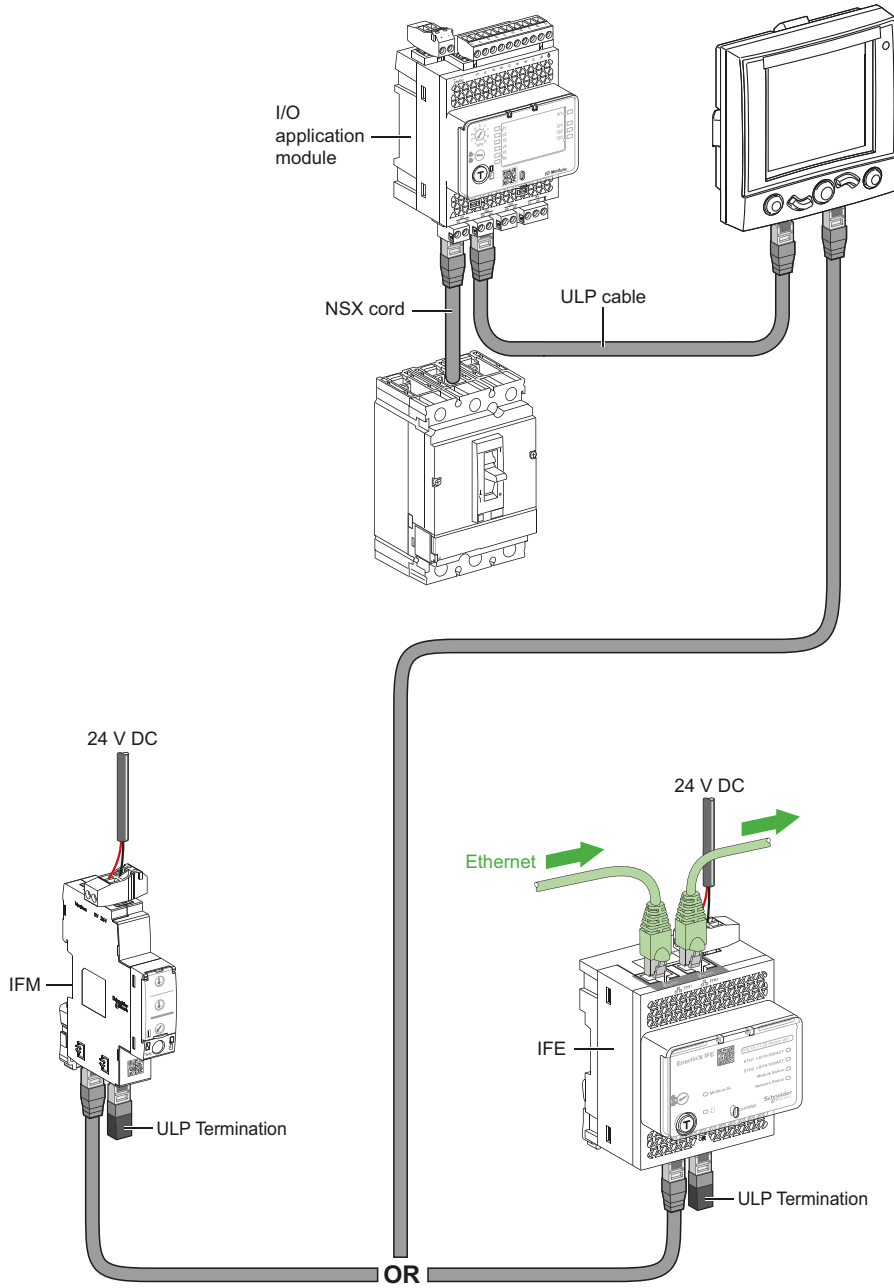

E

# Switchboard integration

## Order your ComPact NSX and NSXm through digital tools

### Product selector

Go on the range page on [www.se.com](http://www.se.com)

The screenshot shows the Schneider Electric website interface. At the top, there is a navigation bar with the logo and menu items: PRODUCTS, SOLUTIONS, SERVICES, SUPPORT, and ABOUT US. A search bar is also present. Below the navigation, a breadcrumb trail reads: Home > Low Voltage Products and Systems > Circuit Breakers and Switches > Molded Case Circuit Breakers > Compact NSXm. The main content area features the title "Compact NSXm" and the subtitle "Molded case circuit breakers up to 160 A". A descriptive paragraph states: "Compact NSXm is the smallest size molded case circuit breaker (MCCB) in the Compact NSX range. With its convenient design, it can easily accommodate applications from 16 to 160 A. Available with integrated earth leakage protection." To the right of the text is an image of the Compact NSXm circuit breaker. Below the text is a blue "Product Selector" button. At the bottom of the page, there are links for "Products", "Presentation", and "Documents & Downloads".

Click on "Product selector" and run your selection

The screenshot displays the "Select your Compact NSXm" product selector tool. The interface is divided into two main sections: "Characteristics" on the left and "My solution" on the right. The "Characteristics" section includes a "Reset" button and a progress indicator "2 / 7". It lists various selection criteria with radio buttons and dropdown menus: "Protection type" (Thermal magnetic (TM-E)), "rated current" (16 A, 25 A, 32 A, 40 A, 50 A, 63 A, 80 A, 100 A, 125 A, 160 A), "poles description" (3P, 4P), "protected poles description" (3d), "rating code" (F), "breaking capacity" (IEC 220-240 V 05 kA, IEC 380-415 V 36 kA, IEC 440 V 35 kA, IEC 500 V 15 kA, IEC 525 V 10 kA), and "connections - terminals" (Evident / Evident, compres lug, ibrcmpres lug bb, other solution). The "Available options" section shows progress indicators: "Rotary handle" (3 / 6), "Tripping release" (2 / 2), "Auxiliary contact", "Locking/Sealing" (3 / 3), and "Upstream connection accessories". The "My solution" section shows the "Selection Name" as "Compact NSXm" and lists "Parts" including "LV426930" (rotary handle black) and "LV426303" (circuit breaker Compact NSXm 40A 3P 36kA at 300A IEC VDE OverLink lug), each with a "Datasheet" link and a quantity of 1. An "Add to cart" button with a quantity of 2 is visible at the bottom right.



# Order your ComPact NSX and NSXm through digital tools

## Product selector

Go on the range page on [www.schneider-electric.com](http://www.schneider-electric.com)

The screenshot shows the Schneider Electric website's product selector for Compact NSX. At the top, there is a navigation bar with the Schneider Electric logo and a search bar. Below the navigation bar, the breadcrumb trail reads: Home > Low Voltage Products and Systems > Circuit Breakers and Switches > Molded Case Circuit Breakers > Compact NSX. The main heading is "Compact NSX" with a sub-heading "Molded case circuit breakers up to 630A". A descriptive paragraph states: "Compact NSX is a full range of high performance molded case circuit breakers (MCCB) in 2 frame sizes designed to meet your needs from thermal-magnetic to advanced Micrologic trip units. This range will soon feature integrated earth leakage protection." To the right of the text is an image of a Compact NSX circuit breaker. Below the text is a blue "Product Selector" button. At the bottom of the page, there are links for "Products", "Presentation", and "Documents & Downloads".

Clic on "Product selector" and run your selection

The screenshot shows the Schneider Electric product selector tool. The main heading is "Select your Compact NSX". The tool is divided into two main sections: "Characteristics" and "My solution". The "Characteristics" section includes several configuration options:
 

- general**: in rated current (400 A, 630 A), rating code (F).
- breaking capacity**: A grid of options including 90 kA 480 V AC, 50 kA 600 V AC, 40 kA 240 V AC, 25 kA 500 V AC (selected), 22 kA 525 V AC, 20 kA 600 V AC, 20 kA 525 V AC, 150 kA 380/415 V AC, and 100 kA 240 V AC.
- operational voltage**: 500 V AC.
- combined reference**: yes (selected), no.
- poles description**: 3P, 4P.
- protected poles description**: 3S.
- circuit breaker application**: distribution (selected).
- trip unit technology**: electronic (selected).

 The "My solution" section on the right lists recommended parts:
 

- LV432591: unit terminal shield - 45mm - 3 poles - Compact NSX400/630 (2 units).
- LV432518: stud for advanced installation - for NS 400, 630 - set of 2 (3 units).
- LV432516: plug-in base - 3 poles - for NSX400, 630 (1 unit).
- LV432533: chassis side plates - 3 poles - 4 poles - for NSX400, 630 (1 unit).
- LV432532: chassis side plates - 3 poles - 4 poles - for NSX400, 630 (1 unit).
- LV432520: safety trip for advanced opening - for compact NSX (1 unit).

 At the bottom right, there is an "Add to cart" button with a shopping cart icon.

F



## Catalog numbers

ComPact NSXm.....	F-3
ComPact NSX100-250.....	F-15
ComPact NSX400-630.....	F-51
Source-changeover systems for 2 devices	
ComPact NSX100 to NSX630 .....	F-76
NSX100/400 for utilities, "tarif jaune" public distribution .....	F-78
Order form .....	F-82

### Other chapters

Select your circuit breakers and switch-disconnectors .....	A-1
Select your protection .....	B-1
Customize your circuit breaker with accessories.....	C-1
Smart Panel integration.....	D-1
Switchboard integration .....	E-1
Glossary .....	G-1
Additional characteristics .....	H-1



## Catalog numbers: ComPact NSXm

### Complete fixed device

ComPact NSXm E/B (16/25 kA at 380/415 V) .....	F-4
ComPact NSXm F/N (36/50 kA at 380/415 V) .....	F-5
ComPact NSXm H (70 kA at 380/415 V) .....	F-6
ComPact NSXm MicroLogic Vigi 4.1 E/B/F (16/25/36 kA at 380/415 V) .....	F-7
ComPact NSXm MicroLogic Vigi 4.1 N/H (50/70kA at 380/415 V) .	F-8
ComPact NSXm NA .....	F-9

### Accessories

Connection and insulation .....	F-10
Electrical auxiliaries.....	F-11
Rotary handles, locks and seals.....	F-12
Spare parts, test tool and software.....	F-13

<b>Other chapters</b>	
Select your circuit breakers and switch-disconnectors .....	A-1
Select your protection .....	B-1
Customize your circuit breaker with accessories.....	C-1
Smart Panel integration.....	D-1
Switchboard integration.....	E-1
Glossary .....	G-1
Additional characteristics .....	H-1

# Complete fixed device

## ComPact NSXm E/B (16/25 kA at 380/415 V)

### ComPact NSXm E (16 kA at 380/415 V)

With thermal-magnetic trip unit TM-D

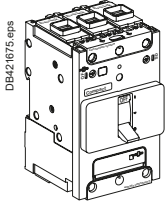

EverLink™ connectors

Rating	3P	4P 3d	4P 4d
TM16D	LV426100	LV426110	LV426120
TM25D	LV426101	LV426111	LV426121
TM32D	LV426102	LV426112	LV426122
TM40D	LV426103	LV426113	LV426123
TM50D	LV426104	LV426114	LV426124
TM63D	LV426105	LV426115	LV426125
TM80D	LV426106	LV426116	LV426126
TM100D	LV426107	LV426117	LV426127
TM125D	LV426108	LV426118	LV426128
TM160D	LV426109	LV426119	LV426129

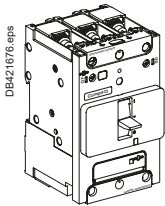

Compression lug/busbar connectors

Rating	3P	4P 3d	4P 4d
TM16D	LV426150	LV426160	LV426170
TM25D	LV426151	LV426161	LV426171
TM32D	LV426152	LV426162	LV426172
TM40D	LV426153	LV426163	LV426173
TM50D	LV426154	LV426164	LV426174
TM63D	LV426155	LV426165	LV426175
TM80D	LV426156	LV426166	LV426176
TM100D	LV426157	LV426167	LV426177
TM125D	LV426158	LV426168	LV426178
TM160D	LV426159	LV426169	LV426179

### ComPact NSXm B (25 kA at 380/415 V)

With thermal-magnetic trip unit TM-D

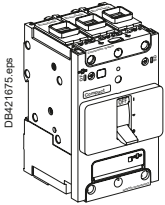

EverLink™ connectors

Rating	3P	4P 3d	4P 4d
TM16D	LV426200	LV426210	LV426220
TM25D	LV426201	LV426211	LV426221
TM32D	LV426202	LV426212	LV426222
TM40D	LV426203	LV426213	LV426223
TM50D	LV426204	LV426214	LV426224
TM63D	LV426205	LV426215	LV426225
TM80D	LV426206	LV426216	LV426226
TM100D	LV426207	LV426217	LV426227
TM125D	LV426208	LV426218	LV426228
TM160D	LV426209	LV426219	LV426229

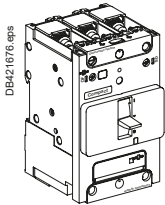

Compression lug/busbar connectors

Rating	3P	4P 3d	4P 4d
TM16D	LV426250	LV426260	LV426270
TM25D	LV426251	LV426261	LV426271
TM32D	LV426252	LV426262	LV426272
TM40D	LV426253	LV426263	LV426273
TM50D	LV426254	LV426264	LV426274
TM63D	LV426255	LV426265	LV426275
TM80D	LV426256	LV426266	LV426276
TM100D	LV426257	LV426267	LV426277
TM125D	LV426258	LV426268	LV426278
TM160D	LV426259	LV426269	LV426279

F

# Complete fixed device

## ComPact NSXm F/N (36/50 kA at 380/415 V)

### ComPact NSXm F (36 kA at 380/415 V)

With thermal-magnetic trip unit TM-D

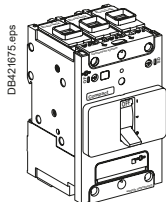

#### EverLink™ connectors

Rating	3P	4P 3d	4P 4d
TM16D	LV426300	LV426310	LV426320
TM25D	LV426301	LV426311	LV426321
TM32D	LV426302	LV426312	LV426322
TM40D	LV426303	LV426313	LV426323
TM50D	LV426304	LV426314	LV426324
TM63D	LV426305	LV426315	LV426325
TM80D	LV426306	LV426316	LV426326
TM100D	LV426307	LV426317	LV426327
TM125D	LV426308	LV426318	LV426328
TM160D	LV426309	LV426319	LV426329

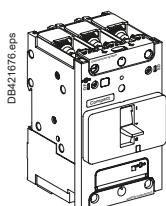

#### Compression lug/busbar connectors

Rating	3P	4P 3d	4P 4d
TM16D	LV426350	LV426360	LV426370
TM25D	LV426351	LV426361	LV426371
TM32D	LV426352	LV426362	LV426372
TM40D	LV426353	LV426363	LV426373
TM50D	LV426354	LV426364	LV426374
TM63D	LV426355	LV426365	LV426375
TM80D	LV426356	LV426366	LV426376
TM100D	LV426357	LV426367	LV426377
TM125D	LV426358	LV426368	LV426378
TM160D	LV426359	LV426369	LV426379

### ComPact NSXm N (50 kA at 380/415 V)

With thermal-magnetic trip unit TM-D

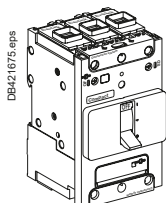

#### EverLink™ connectors

Rating	3P	4P 3d	4P 4d
TM16D	LV426400	LV426410	LV426420
TM25D	LV426401	LV426411	LV426421
TM32D	LV426402	LV426412	LV426422
TM40D	LV426403	LV426413	LV426423
TM50D	LV426404	LV426414	LV426424
TM63D	LV426405	LV426415	LV426425
TM80D	LV426406	LV426416	LV426426
TM100D	LV426407	LV426417	LV426427
TM125D	LV426408	LV426418	LV426428
TM160D	LV426409	LV426419	LV426429

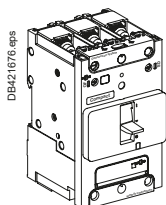

#### Compression lug/busbar connectors

Rating	3P	4P 3d	4P 4d
TM16D	LV426450	LV426460	LV426470
TM25D	LV426451	LV426461	LV426471
TM32D	LV426452	LV426462	LV426472
TM40D	LV426453	LV426463	LV426473
TM50D	LV426454	LV426464	LV426474
TM63D	LV426455	LV426465	LV426475
TM80D	LV426456	LV426466	LV426476
TM100D	LV426457	LV426467	LV426477
TM125D	LV426458	LV426468	LV426478
TM160D	LV426459	LV426469	LV426479

F

# Complete fixed device

## ComPact NSXm H (70 kA at 380/415 V)

### ComPact NSXm H (70 kA at 380/415 V)

With thermal-magnetic trip unit TM-D

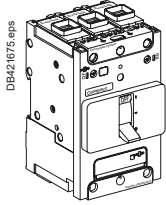

#### EverLink™ connectors

Rating	3P	4P 3d	4P 4d
TM16D	LV426500	LV426510	LV426520
TM25D	LV426501	LV426511	LV426521
TM32D	LV426502	LV426512	LV426522
TM40D	LV426503	LV426513	LV426523
TM50D	LV426504	LV426514	LV426524
TM63D	LV426505	LV426515	LV426525
TM80D	LV426506	LV426516	LV426526
TM100D	LV426507	LV426517	LV426527
TM125D	LV426508	LV426518	LV426528
TM160D	LV426509	LV426519	LV426529

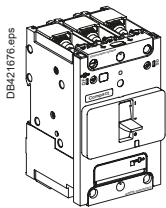

#### Compression lug/busbar connectors

Rating	3P	4P 3d	4P 4d
TM16D	LV426550	LV426560	LV426570
TM25D	LV426551	LV426561	LV426571
TM32D	LV426552	LV426562	LV426572
TM40D	LV426553	LV426563	LV426573
TM50D	LV426554	LV426564	LV426574
TM63D	LV426555	LV426565	LV426575
TM80D	LV426556	LV426566	LV426576
TM100D	LV426557	LV426567	LV426577
TM125D	LV426558	LV426568	LV426578
TM160D	LV426559	LV426569	LV426579

# Complete fixed device

## ComPact NSXm MicroLogic Vigi 4.1 E/B/F

(16/25/36 kA at 380/415 V)

### ComPact NSXm MicroLogic Vigi 4.1 E (16 kA at 380/415 V)

With MicroLogic Vigi 4.1

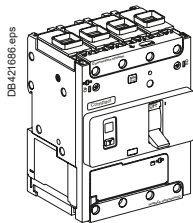

#### EverLink™ connectors

Rating	3P	4P
25 A	LV426700	LV426705
50 A	LV426701	LV426706
100 A	LV426702	LV426707
160 A	LV426703	LV426708

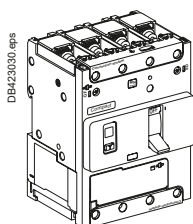

#### Compression lug/busbar connectors

Rating	3P	4P
25 A	LV426750	LV426755
50 A	LV426751	LV426756
100 A	LV426752	LV426757
160 A	LV426753	LV426758

### ComPact NSXm MicroLogic Vigi 4.1 B (25 kA at 380/415 V)

With MicroLogic Vigi 4.1

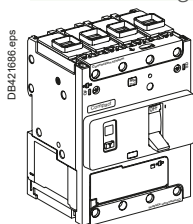

#### EverLink™ connectors

Rating	3P	4P
25 A	LV426710	LV426715
50 A	LV426711	LV426716
100 A	LV426712	LV426717
160 A	LV426713	LV426718

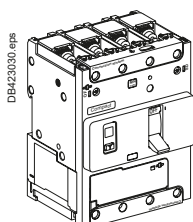

#### Compression lug/busbar connectors

Rating	3P	4P
25 A	LV426760	LV426765
50 A	LV426761	LV426766
100 A	LV426762	LV426767
160 A	LV426763	LV426768

### ComPact NSXm MicroLogic Vigi 4.1 F (36 kA at 380/415 V)

With MicroLogic Vigi 4.1

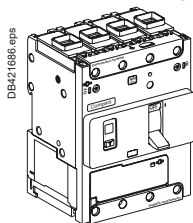

#### EverLink™ connectors

Rating	3P	4P
25 A	LV426720	LV426725
50 A	LV426721	LV426726
100 A	LV426722	LV426727
160 A	LV426723	LV426728

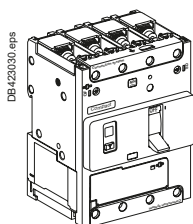

#### Compression lug/busbar connectors

Rating	3P	4P
25 A	LV426770	LV426775
50 A	LV426771	LV426776
100 A	LV426772	LV426777
160 A	LV426773	LV426778

F

# Complete fixed device

## ComPact NSXm MicroLogic Vigi 4.1 N/H (50/70kA at 380/415 V)

### ComPact NSXm MicroLogic Vigi 4.1 N (50 kA at 380/415 V)

With MicroLogic Vigi 4.1

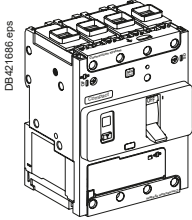

EverLink™ connectors

Rating	3P	4P
25 A	LV426730	LV426735
50 A	LV426731	LV426736
100 A	LV426732	LV426737
160 A	LV426733	LV426738

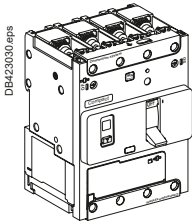

Compression lug/busbar connectors

Rating	3P	4P
25 A	LV426780	LV426785
50 A	LV426781	LV426786
100 A	LV426782	LV426787
160 A	LV426783	LV426788

### ComPact NSXm MicroLogic Vigi 4.1 H (70 kA at 380/415 V)

With MicroLogic Vigi 4.1

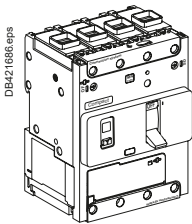

EverLink™ connectors

Rating	3P	4P
25 A	LV426740	LV426745
50 A	LV426741	LV426746
100 A	LV426742	LV426747
160 A	LV426743	LV426748

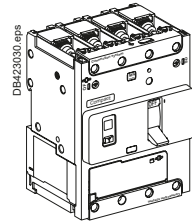

Compression lug/busbar connectors

Rating	3P	4P
25 A	LV426790	LV426795
50 A	LV426791	LV426796
100 A	LV426792	LV426797
160 A	LV426793	LV426798

F



Com**Pact** NSXm NA switch-disconnector

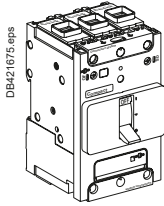

EverLink™ connectors		
Rating	3P	4P
50NA	LV426600	LV426610
100NA	LV426601	LV426611
160NA	LV426602	LV426612

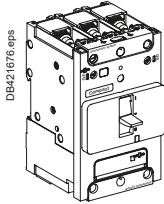

Compression lug/busbar connectors		
Rating	3P	4P
50NA	LV426650	LV426660
100NA	LV426651	LV426661
160NA	LV426652	LV426662

# Accessories

## Connection and insulation

### Connection accessories (Cu or Al)

#### Bare cable connectors

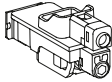
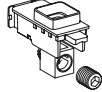
 DB421533.eps	Everlink connector with control wire terminal	1x (2.5 to 95 mm <sup>2</sup> ); ≤ 160 A Cu or ≤ 100 A Al	Set of 3	LV426970
			Set of 4	LV426971
 DB419793.eps	Aluminium connector	1x (2.5 to 70 mm <sup>2</sup> ); ≤ 125 A Cu or Al	Set of 2	LV426966
			Set of 3	LV426967

#### Compression lugs / busbar connectors

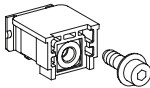
 DB421537.eps	Terminal with nuts and screws M6	≤ 160 A	Set of 3	LV426960
			Set of 4	LV426961

#### Terminal extensions

 DB421538.eps	Spreaders from 27 to 35 mm pitch <sup>[1]</sup>	3P	LV426940
		4P	LV426941

#### Crimp lugs for copper cable <sup>[1]</sup>

 DB421539.eps	For cable 50 mm <sup>2</sup>	Set of 3	LV426978
		Set of 4	LV426979
	For cable 70 mm <sup>2</sup>	Set of 3	LV426980
		Set of 4	LV426981
	For cable 95 mm <sup>2</sup>	Set of 3	LV426982
		Set of 4	LV426983

#### Crimp lugs for aluminium cable <sup>[1]</sup>

 DB421540.eps	For cable 95 mm <sup>2</sup> rigid	Set of 3	LV426984
		Set of 4	LV426985
	For cable 120 mm <sup>2</sup> rigid	Set of 3	LV426976
		Set of 4	LV426977

#### Torque limiting breakaway bits

 DB421541.eps	9 N.m	Set of 6	LV426990
		Set of 8	LV426991
	5 N.m	Set of 6	LV426992
		Set of 8	LV426993

### Insulation accessories

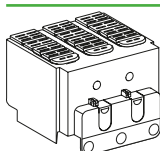
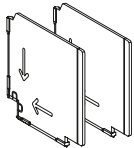
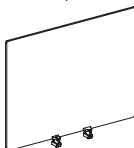
 DB421542.eps	1 long terminal shield	3P	LV426912
		4P	LV426913
 DB421543.eps	Interphase barriers	Set of 6	LV426920
 DB21544eps	2 rear insulation screens	3P	LV426922
		4P	LV426923

[1] Supplied with 2 or 3 interphase barriers.

**Electrical auxiliaries**

**Auxiliary contacts (changeover)**

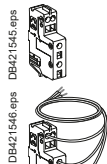

Standard OF or SD	LV426950
Pre-wired OF <sup>[1]</sup>	LV426951
Pre-wired SD <sup>[1]</sup>	LV426952

**SDx for MicroLogic Vigi 4.1**

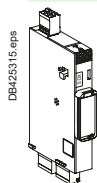

SDx module 24-250 V AC/DC	LV426900
---------------------------	----------

**Voltage releases**



	Standard	Voltage	MX	MN				
AC		24 V 50/60 Hz	LV426841	LV426801				
		48 V 50/60 Hz	LV426842	LV426802				
		110...130 V 50/60 Hz	LV426843	LV426803				
		220...240 V 50 Hz	LV426844	LV426804				
		208...240 V 60 Hz						
		277 V 60 Hz	LV426844	LV426805				
		380...415 V 50 Hz	LV426846	LV426806				
		440...480 V 60 Hz	LV426846	LV426807				
DC		12 V DC	LV426850	-				
		24 V DC	LV426841	LV426801				
		48 V DC	LV426842	LV426802				
		125 V DC	LV426843	LV426803				
		250 V DC	LV426844	LV426815				
Pre-wired <sup>[1]</sup>	AC	Voltage	MX	MN				
					24 V 50/60 Hz	LV426861	LV426821	
					48 V 50/60 Hz	LV426862	LV426822	
					110...130 V 50/60 Hz	LV426863	LV426823	
					220...240 V 50 Hz	LV426864	LV426824	
					208...240 V 60 Hz			
					277 V 60 Hz	LV426864	LV426825	
					380...415 V 50 Hz	LV426866	LV426826	
	440...480 V 60 Hz	LV426866	LV426827					
	DC		Voltage	MX	MN			
						12 V DC	LV426870	-
						24 V DC	LV426861	LV426821
						48 V DC	LV426862	LV426822
						125 V DC	LV426863	LV426823
						250 V DC	LV426864	LV426835



**Time delay unit for undervoltage release (MN)**

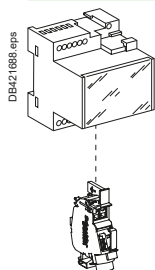

<b>MN 48 V 50/60 Hz with fixed time delay</b>		
Composed of:	MN 48 V DC	LV426802
	Delay unit 48 V 50/60 Hz	LV429426
<b>MN 220-240 V 50/60 Hz with fixed time delay</b>		
Composed of:	MN 250 V DC	LV426815
	Delay unit 220-240 V 50/60 Hz	LV429427
<b>MN 48 V DC/AC 50/60 Hz with adjustable time delay</b>		
Composed of:	MN 48 V DC	LV426802
	Delay unit 48 V DC/AC 50/60 Hz	33680
<b>MN 110-130 V DC/AC 50/60 Hz with adjustable time delay</b>		
Composed of:	MN 125 V DC	LV426803
	Delay unit 100-130 V DC/AC 50/60 Hz	33681
<b>MN 220-250 V DC/AC 50/60 Hz with adjustable time delay</b>		
Composed of:	MN 250 V DC	LV426815
	Delay unit 200-250 V DC/AC 50-60 Hz	33682

[1] Cable: 1 meter long - AWG 18 - 480 V UL certified.



# Accessories



## Rotary handles, locks and seals

### Rotary handle

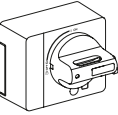
#### Direct rotary handle

	With black handle	LV426930
	With red handle on yellow front	LV426931

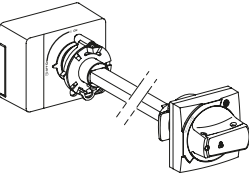
#### Extended rotary handle

	With black handle IP54	LV426932
	With red handle on yellow front IP54	LV426933
	With red handle on yellow front IP65	LV426934
	Open door shaft operator	LV426937
	Laser tool	GVAPL01

#### Side rotary handle

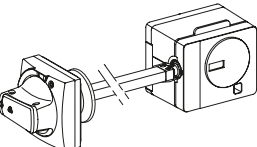
	With black handle IP54	LV426935
	With red handle on yellow front IP54	LV426936

#### Universal handle

	Black handle IP54 (spare part for replacement of front, ext. or side rotary handle)	LV426997
	Red handle on yellow front IP54	LV426998
	Red handle on yellow front IP65	LV426999

### Locks

#### Toggle locking device for 1 to 3 padlocks

	By removable device	29370
	By fixed device (OFF or ON)	LV426905
	By fixed device (OFF only)	LV426906

#### Lead - Sealing accessories

	Bag of accessories	LV429375
---	--------------------	----------

F

# Accessories



## Spare parts, test tool and software

### Spare parts

 DB421557.eps	Front cover	3P	LV426946
	 DB421558.eps	4P	LV426947
		ELCB <sup>[1]</sup>	LV426948

### Test tool, software, demo

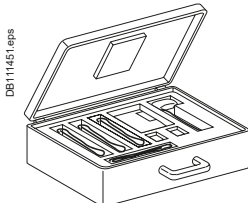
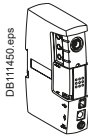
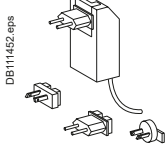
#### Test tool

 DB111449.eps	Pocket battery for MicroLogic		LV434206
 DB111451.eps	Maintenance case		TRV00910
	Comprising: <ul style="list-style-type: none"> <li>■ USB maintenance interface</li> <li>■ Power supply</li> <li>■ MicroLogic cord</li> <li>■ USB cord</li> <li>■ RJ45/RJ45 male cord</li> </ul>		
 DB111450.eps	Spare USB maintenance interface		TRV00911
 DB111452.eps	Spare power supply 110-240 V AC		TRV00915
 DB111453.eps	Spare MicroLogic cord for USB maintenance interface		TRV00917

#### Software

 DB117159.eps	Configuration and setting EcoStruxure Power Commission software		LV4ST100
	Test software LTU		LV4ST121 <sup>[2]</sup>
	Monitoring EcoStruxure Power Commission software		LV4SM100 <sup>[2]</sup>

#### Demo tool

	Demo case for ComPact		LV434207
--	-----------------------	--	----------

[1] ELCB: Earth Leakage Circuit Breaker.

[2] Downloadable from <http://schneider-electric.com>.





F

# Catalog numbers: ComPact NSX100-250

## Complete fixed device

ComPact NSX100/160 1P-2P NSX250N 1P .....	F-16
ComPact NSX100/160/250B (25 kA 380/415 V) .....	F-17
ComPact NSX100/160/250B Vigi add-on (25 kA 380/415 V).....	F-18
ComPact NSX100/160/250F (36 kA 380/415 V).....	F-19
ComPact NSX100/160/250F Vigi add-on (36 kA 380/415 V).....	F-21
ComPact NSX100/160/250N (50 kA 380/415 V) .....	F-22
ComPact NSX100/160/250H (70 kA 380/415 V) .....	F-24
ComPact NSX100/250R (200 kA 380/415 V - 45 kA 690 V).....	F-26
ComPact NSX100/250HB1 (85 kA 500 V - 75 kA 690 V).....	F-28
ComPact NSX100/250HB2 (100 kA 500 V - 100 kA 690 V).....	F-30
ComPact NSX100/160/250NA.....	F-32

## Based on separate components

ComPact NSX100/160/250 .....	F-33
------------------------------	------

## Trip unit accessories

ComPact NSX100/160/250 with/without Vigi add-on .....	F-36
---	------

## Installation and connection

ComPact NSX100/160/250 with/without Vigi add-on .....	F-37
---	------

## Accessories and auxiliaries

ComPact NSX100/160/250 with/without Vigi add-on .....	F-38
---	------



### Other chapters

Select your circuit breakers and switch-disconnectors .....	A-1
Select your protection .....	B-1
Customize your circuit breaker with accessories.....	C-1
Smart Panel integration.....	D-1
Switchboard integration.....	E-1
Glossary .....	G-1
Additional characteristics .....	H-1

# Complete fixed device

## ComPact NSX100/160 1P-2P NSX250N 1P

### ComPact NSX100/160 F/N/M/S 1P/2P

With thermal-magnetic trip unit TM-D

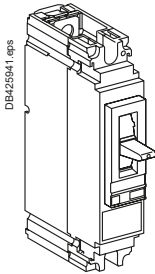

#### ComPact NSX100F AC/DC

Rating	1P 1d (Icu = 18 kA 220/240 V AC)	2P 2d (Icu = 18 kA 380/415 V AC)
TM16D	LV438562	LV438592
TM20D	LV438563	LV438593
TM25D	LV438564	LV438594
TM30D	LV438565	LV438595
TM40D	LV438566	LV438596
TM50D	LV438567	LV438597
TM63D	LV438568	LV438598
TM80D	LV438569	LV438599
TM100D	LV438570	LV438600

#### ComPact NSX100F AC/DC

#### ComPact NSX160F AC/DC

Rating	1P 1d (Icu = 18 kA 220/240 V AC)	2P 2d (Icu = 18 kA 380/415 V AC)
TM125D	LV438669	LV438699
TM160D	LV438670	LV438700

#### ComPact NSX160F AC/DC

#### ComPact NSX100N AC/DC

Rating	1P 1d (Icu = 25 kA 220/240 V AC)	2P 2d (Icu = 25 kA 380/415 V AC)
TM16D	LV438572	LV438602
TM20D	LV438573	LV438603
TM25D	LV438574	LV438604
TM30D	LV438575	LV438605
TM40D	LV438576	LV438606
TM50D	LV438577	LV438607
TM63D	LV438578	LV438608
TM80D	LV438579	LV438609
TM100D	LV438580	LV438610

#### ComPact NSX100M AC/DC

#### ComPact NSX160N AC/DC

Rating	1P 1d (Icu = 25 kA 220/240 V AC)	2P 2d (Icu = 40 kA 380/415 V AC)
TM125D	LV438679	LV438709
TM160D	LV438680	LV438710

#### ComPact NSX160M AC/DC

#### ComPact NSX100M AC/DC

Rating	1P 1d (Icu = 40 kA 220/240 V AC)	2P 2d (Icu = 70 kA 380/415 V AC)
TM16D	LV438582	LV438612
TM20D	LV438583	LV438613
TM25D	LV438584	LV438614
TM30D	LV438585	LV438615
TM40D	LV438586	LV438616
TM50D	LV438587	LV438617
TM63D	LV438588	LV438618
TM80D	LV438589	LV438619
TM100D	LV438590	LV438620

#### ComPact NSX100S AC/DC

#### ComPact NSX160M AC/DC

Rating	1P 1d (Icu = 40 kA 220/240 V AC)	2P 2d (Icu = 70 kA 380/415 V AC)
TM125D	LV438689	LV438719
TM160D	LV438690	LV438720

#### ComPact NSX160S AC/DC

### ComPact NSX250 N 1P

With thermal-magnetic trip unit TM-D

#### ComPact NSX250N AC

Rating	1P 1d (Icu = 25 kA 220/240 V AC)
TM160D	LV438693
TM200D	LV438694
TM250D	LV438695

F



# Complete fixed device

## ComPact NSX100/160/250B (25 kA 380/415 V)

### ComPact NSX100/160/250B

With thermal-magnetic trip unit TM-D

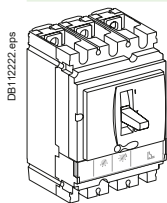

#### ComPact NSX100B (25 kA at 380/415 V)

Rating	3P 2d	3P 3d	4P 3d	4P 4d
TM16D	LV429547	LV429557	LV429567	LV429577
TM25D	LV429546	LV429556	LV429566	LV429576
TM32D	LV429545	LV429555	LV429565	LV429575
TM40D	LV429544	LV429554	LV429564	LV429574
TM50D	LV429543	LV429553	LV429563	LV429573
TM63D	LV429542	LV429552	LV429562	LV429572
TM80D	LV429541	LV429551	LV429561	LV429571
TM100D	LV429540	LV429550	LV429560	LV429570

#### ComPact NSX160B (25 kA at 380/415 V)

Rating	3P 2d	3P 3d	4P 3d	4P 4d
TM80D	LV430303	LV430313	LV430323	LV430333
TM100D	LV430302	LV430312	LV430322	LV430332
TM125D	LV430301	LV430311	LV430321	LV430331
TM160D	LV430300	LV430310	LV430320	LV430330

#### ComPact NSX250B (25 kA at 380/415 V)

Rating	3P 2d	3P 3d	4P 3d	4P 4d
TM125D	LV431103	LV431113	LV431123	LV431133
TM160D	LV431102	LV431112	LV431122	LV431132
TM200D	LV431101	LV431111	LV431121	LV431131
TM250D	LV431100	LV431110	LV431120	LV431130

With electronic trip unit MicroLogic 2.2 (LS<sub>o</sub>I protection)

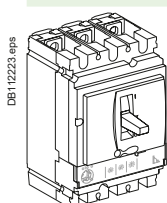

#### ComPact NSX100B (25 kA at 380/415 V)

Rating	3P 3d	4P 3d, 4d, 3d + N/2
40	LV429777	LV429787
100	LV429775	LV429785

#### ComPact NSX160B (25 kA at 380/415 V)

Rating	3P 3d	4P 3d, 4d, 3d + N/2
100	LV430746	LV430751
160	LV430745	LV430750

#### ComPact NSX250B (25 kA at 380/415 V)

Rating	3P 3d	4P 3d, 4d, 3d + N/2
100	LV431142	LV431152
160	LV431141	LV431151
250	LV431140	LV431150

With electronic trip unit MicroLogic Vigi 4.2 (LS<sub>o</sub>IR protection)

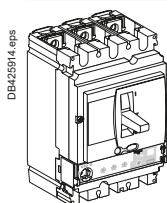

#### ComPact NSX100B (25 kA 380/415V)

Rating	3P 3d	4P 4d, 3d + N/2
40 A	LV433810	LV433818
100 A	LV433811	LV433819

#### ComPact NSX160B (25 kA 380/415V)

Rating	3P 3d	4P 4d, 3d + N/2
100 A	LV433812	LV433820
160 A	LV433813	LV433821

#### ComPact NSX250B (25 kA 380/415V)

Rating	3P 3d	4P 4d, 3d + N/2
100 A	LV433814	LV433822
160 A	LV433815	LV433823
250 A	LV433816	LV433824

With electronic trip unit MicroLogic 5.2 A (LSI protection, ammeter)

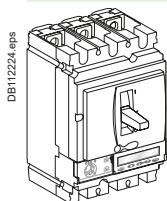

#### ComPact NSX100B (25 kA at 380/415 V)

Rating	3P 3d	4P 3d, 4d, 3d + N/2, 3d + OSN
40	LV429872	LV429877
100	LV429870	LV429875

#### ComPact NSX160B (25 kA at 380/415 V)

Rating	3P 3d	4P 3d, 4d, 3d + N/2, 3d + OSN
100	LV430871	LV430876
160	LV430870	LV430875

#### ComPact NSX250B (25 kA at 380/415 V)

Rating	3P 3d	4P 3d, 4d, 3d + N/2, 3d + OSN
100	LV431147	LV431157
160	LV431146	LV431156
250	LV431145	LV431155

With electronic trip unit MicroLogic 5.2 E (LSI protection, energy meter)

To be ordered with 2 catalog numbers: 1 basic frame + 1 trip unit

With electronic trip unit MicroLogic 6.2 A (LSIG protection, ammeter)

To be ordered with 2 catalog numbers: 1 basic frame + 1 trip unit

With electronic trip unit MicroLogic 6.2 E (LSIG protection, energy meter)

To be ordered with 2 catalog numbers: 1 basic frame + 1 trip unit

F

# Complete fixed device

## ComPact NSX100/160/250B Vigi add-on (25 kA 380/415 V)

### ComPact NSX100/160/250B Vigi add-on

With thermal-magnetic trip unit TM-D

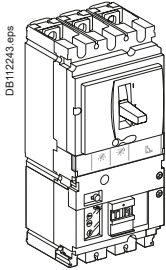

#### ComPact NSX100B (25 kA at 380/415 V) MH Vigi add-on (200 to 440 V)

Rating	3P 3d	4P 3d	4P 4d
TM16D	LV429667	LV429707	LV429967
TM25D	LV429666	LV429706	LV429966
TM32D	LV429665	LV429705	LV429965
TM40D	LV429664	LV429704	LV429964
TM50D	LV429663	LV429703	LV429963
TM63D	LV429662	LV429702	LV429962
TM80D	LV429661	LV429701	LV429961
TM100D	LV429660	LV429700	LV429960

#### ComPact NSX160B (25 kA at 380/415 V) MH Vigi add-on (200 to 440 V)

Rating	3P 3d	4P 3d	4P 4d
TM80D	LV430343	LV430353	LV430363
TM100D	LV430342	LV430352	LV430362
TM125D	LV430341	LV430351	LV430361
TM160D	LV430340	LV430350	LV430360

#### ComPact NSX250B (25 kA at 380/415 V) MH Vigi add-on (200 to 440 V)

Rating	3P 3d	4P 3d	4P 4d
TM125D	LV431903	LV431913	LV431963
TM160D	LV431902	LV431912	LV431962
TM200D	LV431901	LV431911	LV431961
TM250D	LV431900	LV431910	LV431960

With electronic trip unit MicroLogic 2.2 (LS<sub>01</sub> protection)

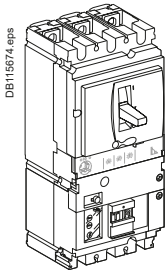

#### ComPact NSX100B (25 kA at 380/415 V) MH Vigi add-on (200 to 440 V)

Rating	3P 3d	4P 3d, 4d, 3d + N/2
40	LV429975	LV429985
100	LV429974	LV429984

#### ComPact NSX160B (25 kA at 380/415 V) MH Vigi add-on (200 to 440 V)

Rating	3P 3d	4P 3d, 4d, 3d + N/2
40	LV430962	LV430997
100	LV430961	LV430996
160	LV430960	LV430995

#### ComPact NSX250B (25 kA at 380/415 V) MH Vigi add-on (200 to 440 V)

Rating	3P 3d	4P 3d, 4d, 3d + N/2
100	LV431977	LV431987
160	LV431976	LV431986
250	LV431975	LV431985

With electronic trip unit MicroLogic 5.2 A or 5.2 E (LSI protection, ammeter or energy meter)

To be ordered with 2 catalog numbers: 1 basic frame + 1 trip unit

# Complete fixed device

## ComPact NSX100/160/250F (36 kA 380/415 V)

### ComPact NSX100/160/250F

With thermal-magnetic trip unit TM-D

DB112222.eps

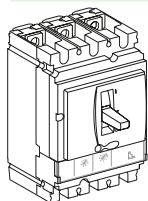

#### ComPact NSX100F (36 kA at 380/415 V)

Rating	3P 2d	3P 3d	4P 3d	4P 4d
TM16D	LV429627	LV429637	LV429647	LV429657
TM25D	LV429626	LV429636	LV429646	LV429656
TM32D	LV429625	LV429635	LV429645	LV429655
TM40D	LV429624	LV429634	LV429644	LV429654
TM50D	LV429623	LV429633	LV429643	LV429653
TM63D	LV429622	LV429632	LV429642	LV429652
TM80D	LV429621	LV429631	LV429641	LV429651
TM100D	LV429620	LV429630	LV429640	LV429650

#### ComPact NSX160F (36 kA at 380/415 V)

Rating	3P 2d	3P 3d	4P 3d	4P 4d
TM80D	LV430623	LV430633	LV430643	LV430653
TM100D	LV430622	LV430632	LV430642	LV430652
TM125D	LV430621	LV430631	LV430641	LV430651
TM160D	LV430620	LV430630	LV430640	LV430650

#### ComPact NSX250F (36 kA at 380/415 V)

Rating	3P 2d	3P 3d	4P 3d	4P 4d
TM125D	LV431623	LV431633	LV431643	LV431653
TM160D	LV431622	LV431632	LV431642	LV431652
TM200D	LV431621	LV431631	LV431641	LV431651
TM250D	LV431620	LV431630	LV431640	LV431650

With electronic trip unit MicroLogic 2.2 (LS<sub>o</sub>I protection)

DB112223.eps

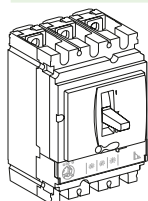

#### ComPact NSX100F (36 kA at 380/415 V)

Rating	3P 3d	4P 3d, 4d, 3d + N/2
40	LV429772	LV429782
100	LV429770	LV429780

#### ComPact NSX160F (36 kA at 380/415 V)

Rating	3P 3d	4P 3d, 4d, 3d + N/2
100	LV430771	LV430781
160	LV430770	LV430780

#### ComPact NSX250F (36 kA at 380/415 V)

Rating	3P 3d	4P 3d, 4d, 3d + N/2
100	LV431772	LV431782
160	LV431771	LV431781
250	LV431770	LV431780

With electronic trip unit MicroLogic Vigi 4.2 (LS<sub>o</sub>IR protection)

DB425914.eps

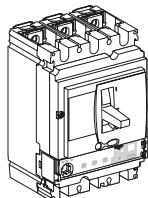

#### ComPact NSX100F (36 kA 380/415V)

Rating	3P 3d	4P 4d, 3d + N/2
40 A	LV433826	LV433834
100 A	LV433827	LV433835

#### ComPact NSX160F (36 kA 380/415V)

Rating	3P 3d	4P 4d, 3d + N/2
100 A	LV433828	LV433836
160 A	LV433829	LV433837

#### ComPact NSX250F (36 kA 380/415V)

Rating	3P 3d	4P 4d, 3d + N/2
100 A	LV433830	LV433838
160 A	LV433831	LV433839
250 A	LV433832	LV433840

With electronic trip unit MicroLogic 5.2 A (LSI protection, ammeter)

DB112224.eps

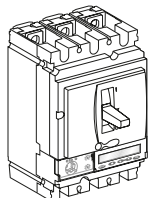

#### ComPact NSX100F (36 kA at 380/415 V)

Rating	3P 3d	4P 3d, 4d, 3d + N/2, 3d + OSN
40	LV429882	LV429887
100	LV429880	LV429885

#### ComPact NSX160F (36 kA at 380/415 V)

Rating	3P 3d	4P 3d, 4d, 3d + N/2, 3d + OSN
100	LV430881	LV430886
160	LV430880	LV430885

#### ComPact NSX250F (36 kA at 380/415 V)

Rating	3P 3d	4P 3d, 4d, 3d + N/2, 3d + OSN
100	LV431862	LV431867
160	LV431861	LV431866
250	LV431860	LV431865

With electronic trip unit MicroLogic 5.2 E (LSI protection, energy meter)

To be ordered with 2 catalog numbers: 1 basic frame + 1 trip unit

With electronic trip unit MicroLogic 6.2 A (LSIG protection, ammeter)

To be ordered with 2 catalog numbers: 1 basic frame + 1 trip unit

With electronic trip unit MicroLogic 6.2 E (LSIG protection, energy meter)

To be ordered with 2 catalog numbers: 1 basic frame + 1 trip unit

# Complete fixed device

## ComPact NSX100/160/250F (36 kA 380/415 V)

### ComPact NSX100/160/250F

#### With magnetic trip unit MA

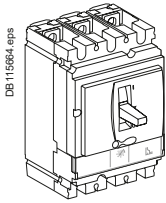

#### ComPact NSX100F (36 kA at 380/415 V)

Rating	3P 3d
MA2.5	LV429745
MA6.3	LV429744
MA12.5	LV429743
MA25	LV429742
MA50	LV429741
MA100	LV429740

#### ComPact NSX160F (36 kA at 380/415 V)

Rating	3P 3d
MA100	LV430831
MA150	LV430830

#### ComPact NSX250F (36 kA at 380/415 V)

Rating	3P 3d
MA150	LV431749
MA220	LV431748

#### With electronic trip unit MicroLogic 2.2 M (LS<sub>o</sub> motor protection)

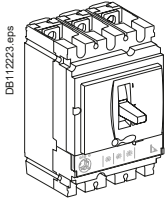

#### ComPact NSX100F (36 kA at 380/415 V)

Rating	3P 3d
25 A	LV429828
50 A	LV429827
100 A	LV429825

#### ComPact NSX160F (36 kA at 380/415 V)

Rating	3P 3d
100 A	LV430986
150 A	LV430985

#### ComPact NSX250F (36 kA at 380/415 V)

Rating	3P 3d
150 A	LV431161
220 A	LV431160

#### With electronic trip unit MicroLogic 6.2 E-M (LSIG motor protection, energy meter)

To be ordered with 2 catalog numbers: 1 basic frame + 1 trip unit

# Complete fixed device

## ComPact NSX100/160/250F Vigi add-on (36 kA 380/415 V)

### ComPact NSX100/160/250F Vigi add-on

With thermal-magnetic trip unit TM-D

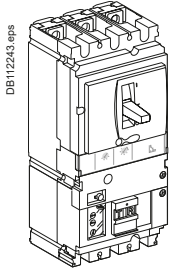

ComPact NSX100F (36 kA at 380/415 V) MH Vigi add-on (200 to 440 V)

Rating	3P 3d	4P 3d	4P 4d
TM16D	LV429937	LV429947	LV429957
TM25D	LV429936	LV429946	LV429956
TM32D	LV429935	LV429945	LV429955
TM40D	LV429934	LV429944	LV429954
TM50D	LV429933	LV429943	LV429953
TM63D	LV429932	LV429942	LV429952
TM80D	LV429931	LV429941	LV429951
TM100D	LV429930	LV429940	LV429950

ComPact NSX160F (36 kA at 380/415 V) MH Vigi add-on (200 to 440 V)

Rating	3P 3d	4P 3d	4P 4d
TM80D	LV430933	LV430943	LV430953
TM100D	LV430932	LV430942	LV430952
TM125D	LV430931	LV430941	LV430951
TM160D	LV430930	LV430940	LV430950

ComPact NSX250F (36 kA at 380/415 V) MH Vigi add-on (200 to 440 V)

Rating	3P 3d	4P 3d	4P 4d
TM125D	LV431933	LV431943	LV431953
TM160D	LV431932	LV431942	LV431952
TM200D	LV431931	LV431941	LV431951
TM250D	LV431930	LV431940	LV431950

With electronic trip unit MicroLogic 2.2 (LS<sub>0</sub>I protection)

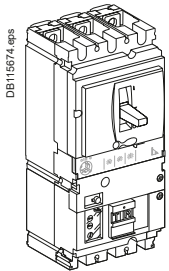

ComPact NSX100F (36 kA at 380/415 V) MH Vigi add-on (200 to 440 V)

Rating	3P 3d	4P 3d, 4d, 3d + N/2
40 A	LV429972	LV429982
100 A	LV429970	LV429980

ComPact NSX160F (36 kA at 380/415 V) MH Vigi add-on (200 to 440 V)

Rating	3P 3d	4P 3d, 4d, 3d + N/2
40 A	LV430973	LV430983
100 A	LV430971	LV430981
160 A	LV430970	LV430980

ComPact NSX250F (36 kA at 380/415 V) MH Vigi add-on (200 to 440 V)

Rating	3P 3d	4P 3d, 4d, 3d + N/2
100 A	LV431972	LV431982
160 A	LV431971	LV431981
250 A	LV431970	LV431980

With electronic trip unit MicroLogic 5.2 A or 5.2 E (LSI protection, energy meter)

To be ordered with 2 catalog numbers: 1 basic frame + 1 trip unit

# Complete fixed device

## ComPact NSX100/160/250N (50 kA 380/415 V)

### ComPact NSX100/160/250N

With thermal-magnetic trip unit TM-D

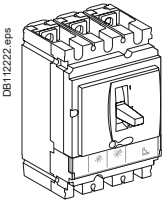

#### ComPact NSX100N (50 kA at 380/415 V)

Rating	3P 3d	4P 3d	4P 4d
TM16D	LV429847	LV429857	LV429867
TM25D	LV429846	LV429856	LV429866
TM32D	LV429845	LV429855	LV429865
TM40D	LV429844	LV429854	LV429864
TM50D	LV429843	LV429853	LV429863
TM63D	LV429842	LV429852	LV429862
TM80D	LV429841	LV429851	LV429861
TM100D	LV429840	LV429850	LV429860

#### ComPact NSX160N (50 kA at 380/415 V)

Rating	3P 3d	4P 3d	4P 4d
TM80D	LV430843	LV430853	LV430863
TM100D	LV430842	LV430852	LV430862
TM125D	LV430841	LV430851	LV430861
TM160D	LV430840	LV430850	LV430860

#### ComPact NSX250N (50 kA at 380/415 V)

Rating	3P 3d	4P 3d	4P 4d
TM125D	LV431833	LV431843	LV431853
TM160D	LV431832	LV431842	LV431852
TM200D	LV431831	LV431841	LV431851
TM250D	LV431830	LV431840	LV431850

With electronic trip unit MicroLogic 2.2 (LS<sub>o</sub>I protection)

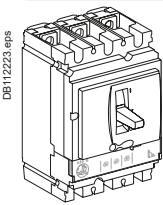

#### ComPact NSX100N (50 kA at 380/415 V)

Rating	3P 3d	4P 3d, 4d, 3d + N/2
40 A	LV429797	LV429807
100 A	LV429795	LV429805

#### ComPact NSX160N (50 kA at 380/415 V)

Rating	3P 3d	4P 3d, 4d, 3d + N/2
100 A	LV430776	LV430786
160 A	LV430775	LV430785

#### ComPact NSX250N (50 kA at 380/415 V)

Rating	3P 3d	4P 3d, 4d, 3d + N/2
100 A	LV431872	LV431877
160 A	LV431871	LV431876
250 A	LV431870	LV431875

With electronic trip unit MicroLogic Vigi 4.2 (LS<sub>o</sub>IR protection)

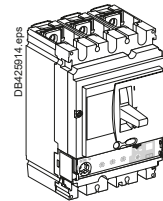

#### ComPact NSX100N (50 kA 380/415V)

Rating	3P 3d	4P 4d, 3d + N/2
40 A	LV433842	LV433850
100 A	LV433843	LV433851

#### ComPact NSX160N (50 kA 380/415V)

Rating	3P 3d	4P 4d, 3d + N/2
100 A	LV433844	LV433852
160 A	LV433845	LV433853

#### ComPact NSX250N (50 kA 380/415V)

Rating	3P 3d	4P 4d, 3d + N/2
100 A	LV433846	LV433854
160 A	LV433847	LV433855
250 A	LV433848	LV433856

With electronic trip unit MicroLogic 5.2 A (LSI protection, ammeter)

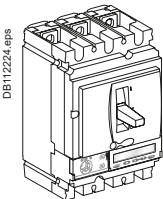

#### ComPact NSX100N (50 kA at 380/415 V)

Rating	3P 3d	4P 3d, 4d, 3d + N/2, OSN
40 A	LV429892	LV429897
100 A	LV429890	LV429895

#### ComPact NSX160N (50 kA at 380/415 V)

Rating	3P 3d	4P 3d, 4d, 3d + N/2, OSN
100 A	LV430891	LV430896
160 A	LV430890	LV430895

#### ComPact NSX250N (50 kA at 380/415 V)

Rating	3P 3d	4P 3d, 4d, 3d + N/2, OSN
100 A	LV431882	LV431887
160 A	LV431881	LV431886
250 A	LV431880	LV431885

With electronic trip unit MicroLogic 5.2 E (LSI protection, energy meter)

To be ordered with 2 catalog numbers: 1 basic frame + 1 trip unit

With electronic trip unit MicroLogic 6.2 A (LSIG protection, ammeter)

To be ordered with 2 catalog numbers: 1 basic frame + 1 trip unit

With electronic trip unit MicroLogic 6.2 E (LSIG protection, energy meter)

To be ordered with 2 catalog numbers: 1 basic frame + 1 trip unit

# Complete fixed device

## ComPact NSX100/160/250N (50 kA 380/415 V)

### ComPact NSX100/160/250N

With magnetic trip unit MA

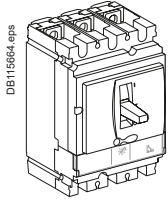

#### ComPact NSX100N (50 kA at 380/415 V)

Rating	3P 3d
MA2.5	LV429755
MA6.3	LV429754
MA12.5	LV429753
MA25	LV429752
MA50	LV429751
MA100	LV429750

#### ComPact NSX160N (50 kA at 380/415 V)

Rating	3P 3d
MA100	LV430833
MA150	LV430832

#### ComPact NSX250N (50 kA at 380/415 V)

Rating	3P 3d
MA150	LV431753
MA220	LV431752

With electronic trip unit MicroLogic 2.2 M (LS<sub>0</sub>I motor protection)

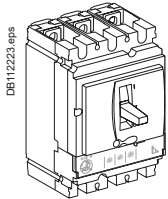

#### ComPact NSX100N (50 kA at 380/415 V)

Rating	3P 3d
25 A	LV429833
50 A	LV429832
100 A	LV429830

#### ComPact NSX160N (50 kA at 380/415 V)

Rating	3P 3d
100 A	LV430989
150 A	LV430988

#### ComPact NSX250N (50 kA at 380/415 V)

Rating	3P 3d
150 A	LV431166
220 A	LV431165

With electronic trip unit MicroLogic 6.2 E-M (LSIG motor protection, energy meter)

To be ordered with 2 catalog numbers: 1 basic frame + 1 trip unit

# Complete fixed device

## ComPact NSX100/160/250H (70 kA 380/415 V)

### ComPact NSX100/160/250H

With thermal-magnetic trip unit TM-D

DB112222.eps

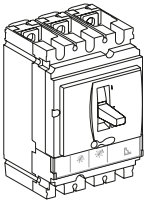

#### ComPact NSX100H (70 kA at 380/415 V)

Rating	3P 3d	4P 3d	4P 4d
TM16D	LV429677	LV429687	LV429697
TM25D	LV429676	LV429686	LV429696
TM32D	LV429675	LV429685	LV429695
TM40D	LV429674	LV429684	LV429694
TM50D	LV429673	LV429683	LV429693
TM63D	LV429672	LV429682	LV429692
TM80D	LV429671	LV429681	LV429691
TM100D	LV429670	LV429680	LV429690

#### ComPact NSX160H (70 kA at 380/415 V)

Rating	3P 3d	4P 3d	4P 4d
TM80D	LV430673	LV430683	LV430693
TM100D	LV430672	LV430682	LV430692
TM125D	LV430671	LV430681	LV430691
TM160D	LV430670	LV430680	LV430690

#### ComPact NSX250H (70 kA at 380/415 V)

Rating	3P 3d	4P 3d	4P 4d
TM125D	LV431673	LV431683	LV431693
TM160D	LV431672	LV431682	LV431692
TM200D	LV431671	LV431681	LV431691
TM250D	LV431670	LV431680	LV431690

With electronic trip unit MicroLogic 2.2 (LS<sub>o</sub>I protection)

DB112223.eps

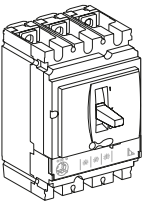

#### ComPact NSX100H (70 kA at 380/415 V)

Rating	3P 3d	4P 3d, 4d, 3d + N/2
40 A	LV429792	LV429802
100 A	LV429790	LV429800

#### ComPact NSX160H (70 kA at 380/415 V)

Rating	3P 3d	4P 3d, 4d, 3d + N/2
100 A	LV430791	LV430801
160 A	LV430790	LV430800

#### ComPact NSX250H (70 kA at 380/415 V)

Rating	3P 3d	4P 3d, 4d, 3d + N/2
100 A	LV431792	LV431802
160 A	LV431791	LV431801
250 A	LV431790	LV431800

With electronic trip unit MicroLogic Vigi 4.2 (LS<sub>o</sub>IR protection)

DB425914.eps

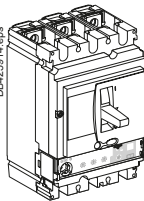

#### ComPact NSX100H (70 kA 380/415V)

Rating	3P 3d	4P 4d, 3d + N/2
40 A	LV433858	LV433866
100 A	LV433859	LV433867

#### ComPact NSX160H (70 kA 380/415V)

Rating	3P 3d	4P 4d, 3d + N/2
100 A	LV433860	LV433868
160 A	LV433861	LV433869

#### ComPact NSX250H (70 kA 380/415V)

Rating	3P 3d	4P 4d, 3d + N/2
100 A	LV433862	LV433870
160 A	LV433863	LV433871
250 A	LV433864	LV433872

With electronic trip unit MicroLogic 5.2 A (LSI protection, ammeter)

DB112224.eps

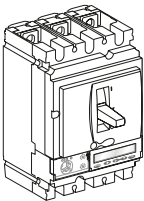

#### ComPact NSX100H (70 kA at 380/415 V)

Rating	3P 3d	4P 3d, 4d, 3d + N/2, OSN
40 A	LV429794	LV429804
100 A	LV429793	LV429803

#### ComPact NSX160H (70 kA at 380/415 V)

Rating	3P 3d	4P 3d, 4d, 3d + N/2, OSN
100 A	LV430795	LV430805
160 A	LV430794	LV430804

#### ComPact NSX250H (70 kA at 380/415 V)

Rating	3P 3d	4P 3d, 4d, 3d + N/2, OSN
100 A	LV431797	LV431807
160 A	LV431796	LV431806
250 A	LV431795	LV431805

With electronic trip unit MicroLogic 5.2 E (LSI protection, energy meter)

To be ordered with 2 catalog numbers: 1 basic frame + 1 trip unit

With electronic trip unit MicroLogic 6.2 A (LSIG protection, ammeter)

To be ordered with 2 catalog numbers: 1 basic frame + 1 trip unit

With electronic trip unit MicroLogic 6.2 E (LSIG protection, energy meter)

To be ordered with 2 catalog numbers: 1 basic frame + 1 trip unit



# Complete fixed device

## ComPact NSX100/160/250H (70 kA 380/415 V)

### ComPact NSX100/160/250H

With magnetic trip unit MA

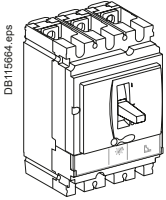

#### ComPact NSX100H (70 kA at 380/415 V)

Rating	3P 3d
MA2.5	LV429765
MA6.3	LV429764
MA12.5	LV429763
MA25	LV429762
MA50	LV429761
MA100	LV429760

#### ComPact NSX160H (70 kA at 380/415 V)

Rating	3P 3d
MA100	LV430835
MA150	LV430834

#### ComPact NSX250H (70 kA at 380/415 V)

Rating	3P 3d
MA150	LV431757
MA220	LV431756

With electronic trip unit MicroLogic 2.2 M (LS<sub>o</sub>I motor protection)

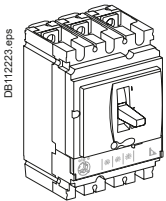

#### ComPact NSX100H (70 kA at 380/415 V)

Rating	3P 3d
25 A	LV429838
50 A	LV429837
100 A	LV429835

#### ComPact NSX160H (70 kA at 380/415 V)

Rating	3P 3d
100 A	LV430992
150 A	LV430991

#### ComPact NSX250H (70 kA at 380/415 V)

Rating	3P 3d
150 A	LV431171
220 A	LV431170

With electronic trip unit MicroLogic 6.2 E-M (LSIG motor protection, energy meter)

To be ordered with 2 catalog numbers: 1 basic frame + 1 trip unit

# Complete fixed device

## ComPact NSX100/250R (200 kA 380/415 V - 45 kA 690 V)

### ComPact NSX100/250R

With thermal-magnetic trip unit TM-D

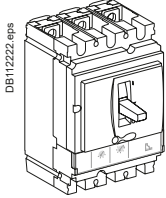

ComPact NSX100R (200 kA at 380/415 V - 45 kA at 690 V)

Rating	3P 3d	4P 4d
TM40D	LV433200	LV433201
TM50D	LV433202	LV433203
TM63D	LV433204	LV433205
TM80D	LV433206	LV433207
TM100D	LV433208	LV433209

ComPact NSX250R (200 kA at 380/415 V - 45 kA at 690 V)

Rating	3P 3d	4P 4d
TM125D	LV433470	LV433471
TM160D	LV433472	LV433473
TM200D	LV433474	LV433475
TM250D	LV433476	LV433477

With electronic trip unit MicroLogic 2.2 (LS<sub>0</sub>I protection)

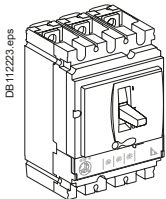

ComPact NSX100R (200 kA at 380/415 V - 45 kA at 690 V)

Rating	3P 3d	4P 3d, 4d, 3d + N/2
40 A	LV433270	LV433271
100 A	LV433272	LV433273

ComPact NSX250R (200 kA at 380/415 V - 45 kA at 690 V)

Rating	3P 3d	4P 3d, 4d, 3d + N/2
100 A	LV433510	LV433511
160 A	LV433512	LV433513
250 A	LV433514	LV433515

With electronic trip unit MicroLogic 5.2 E (LSI protection, energy meter)

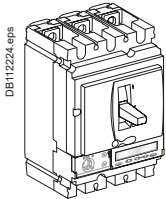

ComPact NSX100R (200 kA at 380/415 V - 45 kA at 690 V)

Rating	3P 3d	4P 3d, 4d, 3d + N/2, OSN
40 A	LV433277	LV433278
100 A	LV433279	LV433280

ComPact NSX250R (200 kA at 380/415 V - 45 kA at 690 V)

Rating	3P 3d	4P 3d, 4d, 3d + N/2, OSN
100 A	LV433518	LV433519
160 A	LV433520	LV433521
250 A	LV433522	LV433523

With electronic trip unit MicroLogic 6.2 E (LSIG protection, energy meter)

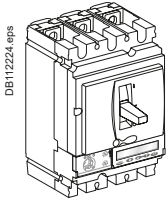

ComPact NSX100R (200 kA at 380/415 V - 45 kA at 690 V)

Rating	3P 3d	4P 3d, 4d, 3d + N/2, OSN
40 A	LV433281	LV433282
100 A	LV433283	LV433284

ComPact NSX250R (200 kA at 380/415 V - 45 kA at 690 V)

Rating	3P 3d	4P 3d, 4d, 3d + N/2, OSN
100 A	LV433524	LV433525
160 A	LV433526	LV433527
250 A	LV433528	LV433529

# Complete fixed device

## ComPact NSX100/250R (200 kA 380/415 V - 45 kA 690 V)

### ComPact NSX100/250R

With magnetic trip unit MA

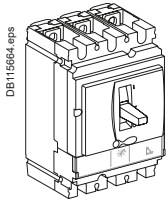

ComPact NSX100R (200 kA at 380/415 V - 45 kA at 690 V)

Rating	3P 3d
MA12.5	LV433242
MA25	LV433243
MA50	LV433244
MA100	LV433245

ComPact NSX250R (200 kA at 380/415 V - 45 kA at 690 V)

Rating	3P 3d
MA150	LV433500
MA220	LV433501

With electronic trip unit MicroLogic 2.2 M (LS<sub>o</sub>I motor protection)

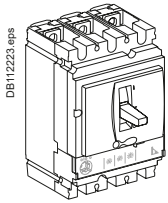

ComPact NSX100R (200 kA at 380/415 V - 45 kA at 690 V)

Rating	3P 3d
25 A	LV433274
50 A	LV433275
100 A	LV433276

ComPact NSX250R (200 kA at 380/415 V - 45 kA at 690 V)

Rating	3P 3d
150 A	LV433516
220 A	LV433517

With electronic trip unit MicroLogic 6.2 E-M (LSIG motor protection, energy meter)

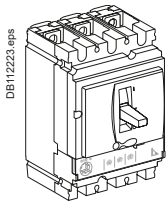

ComPact NSX100R (200 kA at 380/415 V - 45 kA at 690 V)

Rating	3P 3d
25 A	LV433285
50 A	LV433286
80 A	LV433287

ComPact NSX250R (200 kA at 380/415 V - 45 kA at 690 V)

Rating	3P 3d
150 A	LV433530
220 A	LV433531



# Complete fixed device

## ComPact NSX100/250HB1 (85 kA 500 V - 75 kA 690 V)

### ComPact NSX100/250HB1

With thermal-magnetic trip unit TM-D

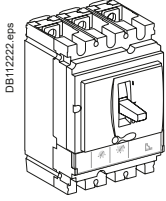

ComPact NSX100HB1 (85 kA at 500 V - 75 kA at 690 V)

Rating	3P 3d	4P 4d
TM40D	LV433210	LV433211
TM50D	LV433212	LV433213
TM63D	LV433214	LV433215
TM80D	LV433216	LV433217
TM100D	LV433218	LV433219

ComPact NSX250HB1 (85 kA at 500 V - 75 kA at 690 V)

Rating	3P 3d	4P 4d
TM125D	LV433478	LV433479
TM160D	LV433480	LV433481
TM200D	LV433482	LV433483
TM250D	LV433484	LV433485

With electronic trip unit MicroLogic 2.2 (LS<sub>0</sub>I protection)

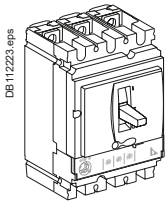

ComPact NSX100HB1 (85 kA at 500 V - 75 kA at 690 V)

Rating	3P 3d	4P 3d, 4d, 3d + N/2
40 A	LV433300	LV433301
100 A	LV433302	LV433303

ComPact NSX250HB1 (85 kA at 500 V - 75 kA at 690 V)

Rating	3P 3d	4P 3d, 4d, 3d + N/2
100 A	LV433540	LV433541
160 A	LV433542	LV433543
250 A	LV433544	LV433545

With electronic trip unit MicroLogic 5.2 E (LSI protection, energy meter)

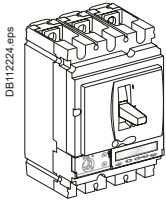

ComPact NSX100HB1 (85 kA at 500 V - 75 kA at 690 V)

Rating	3P 3d	4P 3d, 4d, 3d + N/2, OSN
40 A	LV433307	LV433308
100 A	LV433309	LV433310

ComPact NSX250HB1 (85 kA at 500 V - 75 kA at 690 V)

Rating	3P 3d	4P 3d, 4d, 3d + N/2, OSN
100 A	LV433548	LV433549
160 A	LV433550	LV433551
250 A	LV433552	LV433553

With electronic trip unit MicroLogic 6.2 E (LSIG protection, energy meter)

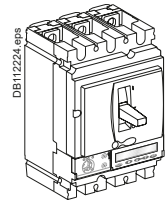

ComPact NSX100HB1 (85 kA at 500 V - 75 kA at 690 V)

Rating	3P 3d	4P 3d, 4d, 3d + N/2, OSN
40 A	LV433311	LV433312
100 A	LV433313	LV433314

ComPact NSX250HB1 (85 kA at 500 V - 75 kA at 690 V)

Rating	3P 3d	4P 3d, 4d, 3d + N/2, OSN
100 A	LV433554	LV433555
160 A	LV433556	LV433557
250 A	LV433558	LV433559

# Complete fixed device

## ComPact NSX100/250HB1 (85 kA 500 V - 75 kA 690 V)

### ComPact NSX100/250HB1

With magnetic trip unit MA

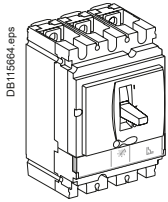

ComPact NSX100HB1 (85 kA at 500 V - 75 kA at 690 V)

Rating	3P 3d
MA12.5	LV433248
MA25	LV433249
MA50	LV433250
MA100	LV433251

ComPact NSX250HB1 (85 kA at 500 V - 75 kA at 690 V)

Rating	3P 3d
MA150	LV433502
MA220	LV433503

With electronic trip unit MicroLogic 2.2 M (LS<sub>o</sub>I motor protection)

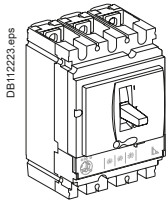

ComPact NSX100HB1 (85 kA at 500 V - 75 kA at 690 V)

Rating	3P 3d
25 A	LV433304
50 A	LV433305
100 A	LV433306

ComPact NSX250HB1 (85 kA at 500 V - 75 kA at 690 V)

Rating	3P 3d
150 A	LV433546
220 A	LV433547

With electronic trip unit MicroLogic 6.2 E-M (LSIG motor protection, energy meter)

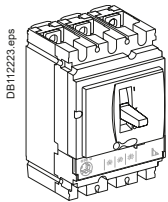

ComPact NSX100HB1 (85 kA at 500 V - 75 kA at 690 V)

Rating	3P 3d
25 A	LV433315
50 A	LV433316
80 A	LV433317

ComPact NSX250HB1 (85 kA at 500 V - 75 kA at 690 V)

Rating	3P 3d
150 A	LV433560
220 A	LV433561



# Complete fixed device

## ComPact NSX100/250HB2 (100 kA 500 V - 100 kA 690 V)

### ComPact NSX100/250HB2

With thermal-magnetic trip unit TM-D

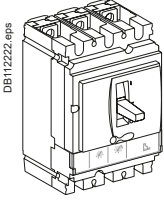

ComPact NSX100HB2 (100 kA at 500 V - 100 kA at 690 V)

Rating	3P 3d	4P 4d
TM63D	LV433224	LV433225
TM80D	LV433226	LV433227
TM100D	LV433228	LV433229

ComPact NSX250HB2 (100 kA at 500 V - 100 kA at 690 V)

Rating	3P 3d	4P 4d
TM125D	LV433486	LV433487
TM160D	LV433488	LV433489
TM200D	LV433490	LV433491
TM250D	LV433492	LV433493

With electronic trip unit MicroLogic 2.2 (LS<sub>0</sub>I protection)

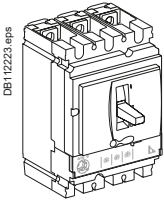

ComPact NSX100HB2 (100 kA at 500 V - 100 kA at 690 V)

Rating	3P 3d	4P 3d, 4d, 3d + N/2
40 A	LV433330	LV433331
100 A	LV433332	LV433333

ComPact NSX250HB2 (100 kA at 500 V - 100 kA at 690 V)

Rating	3P 3d	4P 3d, 4d, 3d + N/2
100 A	LV433570	LV433571
160 A	LV433572	LV433573
250 A	LV433574	LV433575

With electronic trip unit MicroLogic 5.2 E (LSI protection, energy meter)

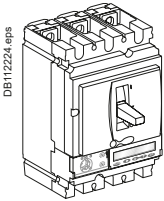

ComPact NSX100HB2 (100 kA at 500 V - 100 kA at 690 V)

Rating	3P 3d	4P 3d, 4d, 3d + N/2, OSN
40 A	LV433337	LV433338
100 A	LV433339	LV433340

ComPact NSX250HB2 (100 kA at 500 V - 100 kA at 690 V)

Rating	3P 3d	4P 3d, 4d, 3d + N/2, OSN
100 A	LV433578	LV433579
160 A	LV433580	LV433581
250 A	LV433582	LV433583

With electronic trip unit MicroLogic 6.2 E (LSIG protection, energy meter)

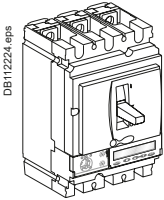

ComPact NSX100HB2 (100 kA at 500 V - 100 kA at 690 V)

Rating	3P 3d	4P 3d, 4d, 3d + N/2, OSN
40 A	LV433341	LV433342
100 A	LV433343	LV433344

ComPact NSX250HB2 (100 kA at 500 V - 100 kA at 690 V)

Rating	3P 3d	4P 3d, 4d, 3d + N/2, OSN
100 A	LV433584	LV433585
160 A	LV433586	LV433587
250 A	LV433588	LV433589

# Complete fixed device

## ComPact NSX100/250HB2 (100 kA 500 V - 100 kA 690 V)

### ComPact NSX100/250HB2

With magnetic trip unit MA

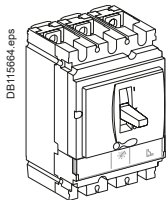

ComPact NSX100HB2 (100 kA at 500 V - 100 kA at 690 V)

Rating	3P 3d
MA12.5	LV433254
MA25	LV433255
MA50	LV433256
MA100	LV433257

ComPact NSX250HB2 (100 kA at 500 V - 100 kA at 690 V)

Rating	3P 3d
MA150	LV433504
MA220	LV433505

With electronic trip unit MicroLogic 2.2 M (LS<sub>o</sub>I motor protection)

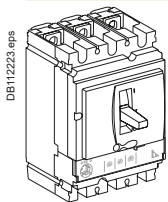

ComPact NSX100HB2 (100 kA at 500 V - 100 kA at 690 V)

Rating	3P 3d
25 A	LV433334
50 A	LV433335
100 A	LV433336

ComPact NSX250HB2 (100 kA at 500 V - 100 kA at 690 V)

Rating	3P 3d
150 A	LV433576
220 A	LV433577

With electronic trip unit MicroLogic 6.2 E-M (LSIG motor protection, energy meter)

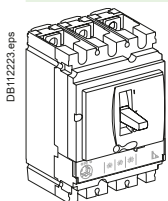

ComPact NSX100HB2 (100 kA at 500 V - 100 kA at 690 V)

Rating	3P 3d
25 A	LV433345
50 A	LV433346
80 A	LV433347

ComPact NSX250HB2 (100 kA at 500 V - 100 kA at 690 V)

Rating	3P 3d
150 A	LV433590
220 A	LV433591



# Complete fixed device

## ComPact NSX100/160/250NA

### ComPact NSX100/160/250NA switch-disconnector

With NA switch-disconnector unit

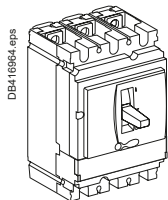

#### ComPact NSX100NA

Rating	<b>2P</b>	<b>3P</b>	<b>4P</b>
100 A	<b>LV429619</b>	<b>LV429629</b>	<b>LV429639</b>

#### ComPact NSX160NA

Rating	<b>2P</b>	<b>3P</b>	<b>4P</b>
160 A	<b>LV430619</b>	<b>LV430629</b>	<b>LV430639</b>

#### ComPact NSX250NA

Rating	<b>2P</b>	<b>3P</b>	<b>4P</b>
250 A	<b>LV431619</b>	<b>LV431629</b>	<b>LV431639</b>



## Based on separate components

## ComPact NSX100/160/250

## Basic frame

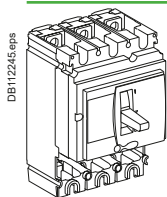

DB112245.eps

## ComPact NSX100

	3P	4P
NSX100B (25 kA 380/415 V)	LV429014	LV429015
NSX100F (36 kA 380/415 V)	LV429003	LV429008
NSX100N (50 kA 380/415 V)	LV429006	LV429011
NSX100H (70 kA 380/415 V)	LV429004	LV429009
NSX100S (100 kA 380/415 V)	LV429018	LV429019
NSX100L (150 kA 380/415 V)	LV429005	LV429010

## ComPact NSX160

	3P	4P
NSX160B (25 kA 380/415 V)	LV430390	LV430395
NSX160F (36 kA 380/415 V)	LV430403	LV430408
NSX160N (50 kA 380/415 V)	LV430406	LV430411
NSX160H (70 kA 380/415 V)	LV430404	LV430409
NSX160S (100 kA 380/415 V)	LV430391	LV430396
NSX160L (150 kA 380/415 V)	LV430405	LV430410

## ComPact NSX250

	3P	4P
NSX250B (25 kA 380/415 V)	LV431390	LV431395
NSX250F (36 kA 380/415 V)	LV431403	LV431408
NSX250N (50 kA 380/415 V)	LV431406	LV431411
NSX250H (70 kA 380/415 V)	LV431404	LV431409
NSX250S (100 kA 380/415 V)	LV431391	LV431396
NSX250L (150 kA 380/415 V)	LV431405	LV431410

## + Trip unit

## Distribution protection

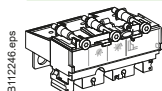

DB112246.eps

## Thermal-magnetic TM-D

Rating	3P 3d	4P 3d	4P 4d
TM16D	LV429037	LV429047	LV429057
TM25D	LV429036	LV429046	LV429056
TM32D	LV429035	LV429045	LV429055
TM40D	LV429034	LV429044	LV429054
TM50D	LV429033	LV429043	LV429053
TM63D	LV429032	LV429042	LV429052
TM80D	LV429031	LV429041	LV429051
TM100D	LV429030	LV429040	LV429050
TM125D	LV430431	LV430441	LV430451
TM160D <sup>[1]</sup>	LV430430	LV430440	LV430450
TM160D <sup>[2]</sup>	LV431432	LV431442	LV431452
TM200D	LV431431	LV431441	LV431451
TM250D	LV431430	LV431440	LV431450

MicroLogic 2.2 (LS<sub>o</sub>I protection)

Rating	3P 3d	4P 3d, 4d, 3d + N/2
40 A	LV429072	LV429082
100 A	LV429070	LV429080
160 A	LV430470	LV430480
250 A	LV431470	LV431480

## MicroLogic 5.2 A (LSI protection, ammeter)

Rating	3P 3d	4P 3d, 4d, 3d + N/2, 3d + OSN
40 A	LV429091	LV429101
100 A	LV429090	LV429100
160 A	LV430490	LV430495
250 A	LV431490	LV431495

## MicroLogic 5.2 E (LSI protection, energy meter)

Rating	3P 3d	4P 3d, 4d, 3d + N/2, 3d + OSN
40 A	LV429096	LV429106
100 A	LV429095	LV429105
160 A	LV430491	LV430496
250 A	LV431491	LV431496

## MicroLogic 6.2 A (LSIG protection, ammeter)

Rating	3P 3d	4P 3d, 4d, 3d + N/2, 3d + OSN
40 A	LV429111	LV429136
100 A	LV429110	LV429135
160 A	LV430505	LV430515
250 A	LV431505	LV431515

## MicroLogic 6.2 E (LSIG protection, energy meter)

Rating	3P 3d	4P 3d, 4d, 3d + N/2, 3d + OSN
40 A	LV429116	LV429141
100 A	LV429115	LV429140
160 A	LV430506	LV430516
250 A	LV431506	LV431516

[1] For NSX160.

[2] For NSX250.

# Based on separate components

## ComPact NSX100/160/250

### + Trip unit (cont.)

#### Distribution protection with embedded earth leakage protection

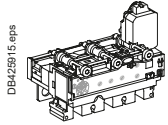

##### MicroLogic Vigi 4.2 (LS<sub>o</sub>IR protection)

Rating	3P 3d	4P 4d 3d + N/2
40 A	LV433800	LV433805
100 A	LV433801	LV433806
160 A	LV433802	LV433807
250 A	LV433803	LV433808

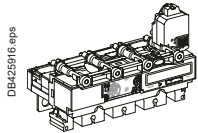

##### MicroLogic Vigi 7.2 E (LSIR protection)

Rating	3P 3d	4P 4d 3d + N/2
40 A	-	LV433879
100 A	-	LV433880
160 A	-	LV433881
250 A	-	LV433882

#### Distribution protection with embedded earth leakage alarm

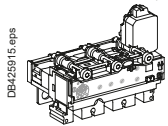

##### MicroLogic Vigi 4.2 AL (LS<sub>o</sub>I protection + earth leakage alarm)

Rating	3P 3d	4P 4d 3d + N/2
40 A	LV433884	LV433889
100 A	LV433885	LV433890
160 A	LV433886	LV433891
250 A	LV433887	LV433892

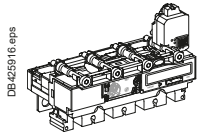

##### MicroLogic Vigi 7.2 E AL (LSI protection + earth leakage alarm)

Rating	3P 3d	4P 4d 3d + N/2
40 A	-	LV433898
100 A	-	LV433899
160 A	-	LV433900
250 A	-	LV433901

#### Motor protection

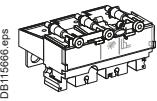

##### Magnetic MA (I protection)

Rating	3P 3d	4P 3d
MA2.5	LV429125	
MA6.3	LV429124	
MA12.5	LV429123	
MA25	LV429122	
MA50	LV429121	
MA100	LV429120	LV429130
MA150	LV430500	LV430510
MA220	LV431500	LV431510

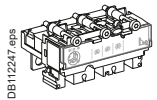

##### MicroLogic 2.2 M (LS<sub>o</sub>I protection)

Rating	3P 3d
25 A	LV429174
50 A	LV429172
100 A	LV429170
150 A	LV430520
220 A	LV431520

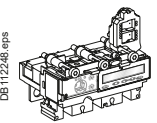

##### MicroLogic 6.2 E-M (LSIG protection, energy meter)

Rating	3P 3d
25 A	LV429184
50 A	LV429182
80 A	LV429180
150 A	LV430521
220 A	LV431521

#### Generator protection

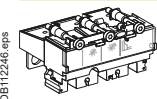

##### Thermal-magnetic TM-G

Rating	3P 3d	4P 4d
TM16G	LV429155	LV429165
TM25G	LV429154	LV429164
TM40G	LV429153	LV429163
TM63G	LV429152	LV429162
TM80G	LV430080	LV430092
TM100G	LV430081	LV430093
TM125G	LV430082	LV430094
TM160G	LV430083	LV430095
TM200G	LV430084	LV430096
TM250G	LV430085	LV430097

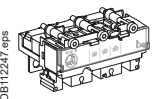

##### MicroLogic 2.2 G (LS<sub>o</sub>I protection)

Rating	3P 3d	4P 3d, 4d, 3d + N/2
40 A	LV429076	LV429086
100 A	LV429075	LV429085
160 A	LV430475	LV430485
250 A	LV431475	LV431485

F

# Based on separate components

## ComPact NSX100/160/250

### + Trip unit (cont.)

#### Protection of public distribution systems

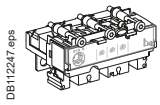

##### MicroLogic 2.2 AB (LS<sub>0</sub>I protection)

Rating	4P 3d, 4d, 3d + N/2
100 A	LV434550
160 A	LV434551
240 A	LV434554

#### Earth Leakage protection of public distribution systems

##### MicroLogic Vigi 4.2 AB distribution protections

Rating	4P 3d, 4d, 3d + N/2
100 A	LV433804
160 A	LV433809
250 A	LV433817

#### 16 Hz 2/3 network protection

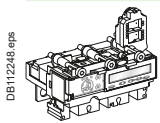

##### MicroLogic 5.2 A-Z (LSI protection, ammeter)

Rating	3P 3d
100 A	LV429089
250 A	LV431489

### + Vigi add-on or Vigi add-on Alarm

#### Vigi add-on

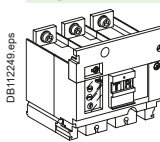

	3P	4P
ME type for NSX100/160 (200 to 440 V)	LV429212	LV429213
MH type for NSX100/160 (200 to 440 V)	LV429210	LV429211
MH type for NSX250 (200 to 440 V)	LV431535	LV431536
MH type for NSX100/160 (440 to 550 V)	LV429215	LV429216
MH type for NSX250 (440 to 550 V)	LV431533	LV431534
Connection for a 4P Vigi on a 3P breaker		LV429214

#### Vigi add-on Alarm

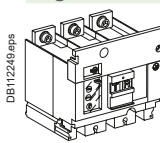

	3P	4P
200 to 440 V AC	LV429459	LV429460
Connection for a 4P insulation monitoring module on a 3P breaker		LV429214



## Catalog numbers

## Trip unit accessories

## ComPact NSX100/160/250 with/without Vigi add-on

## Trip unit accessories

## External neutral CT for 3 pole breaker with MicroLogic 5/6

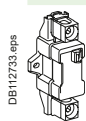

25-100 A	LV429521
150-250 A	LV430563

## 24 V DC wiring accessory for MicroLogic 5/6



24 V DC power supply connector	LV434210
--------------------------------	----------

## ZSI wiring accessory for NS630b NW with NSX

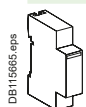

ZSI module	LV434212
------------	----------

## External power supply module (24 V DC - 1 A), class 4

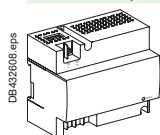

24-30 V DC	LV454440
48-60 V DC	LV454441
100-125 V DC	LV454442
110-130 V AC	LV454443
200-240 V AC	LV454444

## Battery module

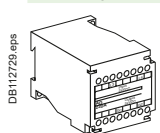

24 V DC battery module	54446
------------------------	-------

# Installation and connection

## ComPact NSX100/160/250 with/without Vigi add-on

### Fixed/RC device = fixed/FC device + rear connection kit



Short RC kit			
Kit 3P		3 x	<b>LV429235</b>
Kit 4P		4 x	<b>LV429235</b>
Mixed RC kit			
Kit 3P	Short RCs	2 x	<b>LV429235</b>
	Long RCs	1 x	<b>LV429236</b>
Kit 4P	Short RCs	2 x	<b>LV429235</b>
	Long RCs	2 x	<b>LV429236</b>

### Plug-in version = fixed/FC device + plug-in kit

#### Kit for ComPact NSX

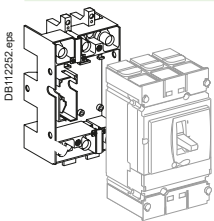

Plug-in kit	2P (3P) LV429288	3P LV429289	4P LV429290
Comprising:			
Base	= 1 x LV429265	= 1 x LV429266	= 1 x LV429267
Power connections	+ 2 x LV429268	+ 3 x LV429268	+ 4 x LV429268
Short terminal shields	+ 2 x LV429515	+ 2 x LV429515	+ 2 x LV429516
Safety trip interlock	+ 1 x LV429270	+ 1 x LV429270	+ 1 x LV429270

#### Kit for ComPact NSX Vigi add-on

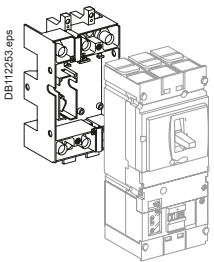

ComPact NSX Vigi add-on plug-in kit	3P LV429291	4P LV429292
Comprising:		
Base	= 1 x LV429266	= 1 x LV429267
Power connections	+ 3 x LV429269	+ 4 x LV429269
Short terminal shields	+ 2 x LV429515	+ 2 x LV429516
Safety trip interlock	+ 1 x LV429270	+ 1 x LV429270

### Withdrawable version = fixed/FC device + withdrawable kit

#### Kit for ComPact NSX

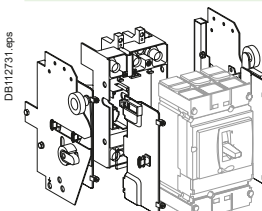

	2P (3P) Kit for ComPact NSX	3P Kit for ComPact NSX	4P Kit for ComPact NSX
Plug-in kit	= 1 x LV429288	= 1 x LV429289	= 1 x LV429290
Chassis side plates for base	+ 1 x LV429282	+ 1 x LV429282	+ 1 x LV429282
Chassis side plates for breaker	+ 1 x LV429283	+ 1 x LV429283	+ 1 x LV429283

#### Kit for ComPact NSX Vigi add-on

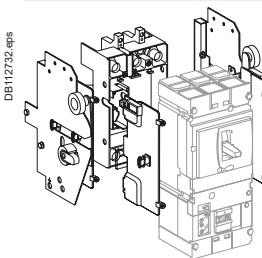

	3P Kit for Vigi add-on	4P Kit for Vigi add-on
Plug-in kit	= 1 x LV429291	= 1 x LV429292
Chassis side plates for base	+ 1 x LV429282	+ 1 x LV429282
Chassis side plates for breaker	+ 1 x LV429283	+ 1 x LV429283



# Accessories and auxiliaries



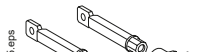

## ComPact NSX100/160/250 with/without Vigi add-on

### Connection accessories (Cu or Al)

#### Rear connections

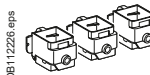
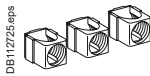
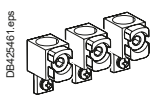
	2 short	LV429235
	2 long	LV429236

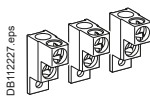
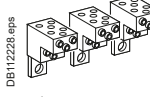
#### Bare cable connectors

	Steel connectors	1 x (1.5 to 95 mm <sup>2</sup> ) ; ≤ 160 A	Set of 2	LV429246
			Set of 3	LV429242
			Set of 4	LV429243
	Aluminium connectors	1 x (25 to 95 mm <sup>2</sup> ) ; ≤ 250 A	Set of 2	LV429255
			Set of 3	LV429227
			Set of 4	LV429228
		1 x (120 to 185 mm <sup>2</sup> ) ; ≤ 250 A	Set of 2	LV429247
			Set of 3	LV429259
			Set of 4	LV429260
		1 x (120 to 240 mm <sup>2</sup> ) ; ≤ 250 A	Set of 3	LV429244
		Set of 4	LV429245	
	Clips for connectors		Set of 10	LV429241
	Aluminium connectors for 2 cables <sup>[1]</sup>	2 x (50 to 120 mm <sup>2</sup> ) ; ≤ 250 A	Set of 3	LV429218
			Set of 4	LV429219
	Aluminium connectors <sup>[1]</sup> for 6 cables	6 x (1.5 to 35 mm <sup>2</sup> ) ; ≤ 250 A	Set of 3	LV429248
			Set of 4	LV429249
	6.35 mm voltage tap for aluminium connectors for 1 or 2 cables		Set of 10	LV429348

#### Lineryg DX and Lineryg DP distribution block (for bare cable)

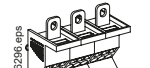
	160 A (40 °C) 6 cables S ≤ 10 mm <sup>2</sup>	1P	04031
	250 A (40 °C) 9 cables S ≤ 10 mm <sup>2</sup>	3P	04033
		4P	04034

#### Terminal extensions

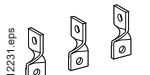
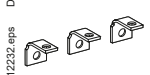
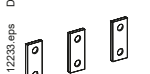
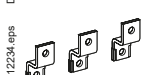
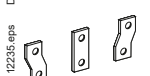
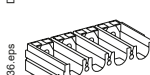
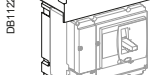
	45° terminal extension <sup>[1]</sup>	Set of 3	LV429223
		Set of 4	LV429224
	Edgewise terminal extensions <sup>[1]</sup>	Set of 3	LV429308
		Set of 4	LV429309
	Right-angle terminal extensions <sup>[1]</sup>	Set of 2	LV429250
		Set of 3	LV429261
		Set of 4	LV429262
	Straight terminal extensions <sup>[1]</sup>	Set of 2	LV429251
		Set of 3	LV429263
		Set of 4	LV429264
	Double-L terminal extensions <sup>[1]</sup>	Set of 3	LV429221
		Set of 4	LV429222
	Spreaders from 35 to 45 mm pitch <sup>[1]</sup>	3P	LV431563
		4P	LV431564
	One-piece spreader from 35 to 45 mm pitch	3P	LV431060
		4P	LV431061
	Front alignment base (for one-piece spreader)	3P/4P	LV431064

[1] Supplied with 2 or 3 interphase barriers.

# Accessories and auxiliaries

## ComPact NSX100/160/250 with/without Vigi add-on

### Crimp lugs for copper cable<sup>[1]</sup>

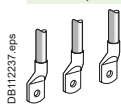

For cable 120 mm <sup>2</sup>	Set of 3	LV429252
	Set of 4	LV429256
For cable 150 mm <sup>2</sup>	Set of 3	LV429253
	Set of 4	LV429257
For cable 185 mm <sup>2</sup>	Set of 3	LV429254
	Set of 4	LV429258

### Crimp lugs for aluminium cable<sup>[1]</sup>

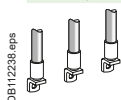

For cable 150 mm <sup>2</sup>	Set of 3	LV429504
	Set of 4	LV429505
For cable 185 mm <sup>2</sup>	Set of 3	LV429506
	Set of 4	LV429507

### Insulation accessories

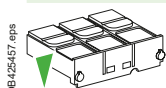

1 short terminal shield for breaker or plug-in base	3P	LV429515
	4P	LV429516

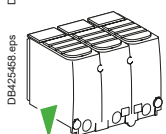

1 long terminal shield for breaker or plug-in base	3P	LV429517
	4P	LV429518

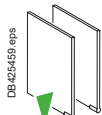

Interphase barriers for breaker or plug-in base	Set of 6	LV429329
---	----------	----------

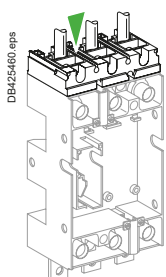

Connection adapter for plug-in base	3P	LV429306
	4P	LV429307

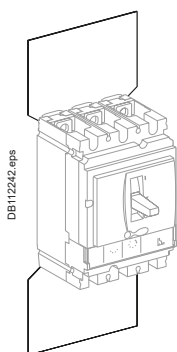

2 insulating screens for breaker (45 mm pitch)	3P	LV429330
	4P	LV429331

[1] Supplied with 2 or 3 interphase barriers.



# Accessories and auxiliaries

## ComPact NSX100/160/250 with/without Vigi add-on

### Electrical auxiliaries

#### Auxiliary contacts (changeover)

DB112254.eps 	OF or SD or SDE or SDV	<b>29450</b>
	OF or SD or SDE or SDV low level	<b>29452</b>
	SDE adapter, mandatory for trip unit TM, MA or MicroLogic 2	<b>LV429451</b>

#### SDx output module for MicroLogic

DB112275.eps 	SDx module 24/415 V AC/DC	<b>LV429532</b>
---	---------------------------	-----------------

#### SDTAM contactor tripping module (early-break thermal fault signal) for MicroLogic 2.2 M/6.2 E-M

DB112276.eps 	SDTAM 24/415 V AC/DC overload fault indication	<b>LV429424</b>
---	--	-----------------

#### Voltage releases

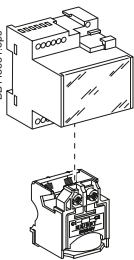
	Voltage	MX	MN	
DB111454.eps 	AC			
		24 V 50/60 Hz	<b>LV429384</b>	<b>LV429404</b>
		48 V 50/60 Hz	<b>LV429385</b>	<b>LV429405</b>
		110-130 V 50/60 Hz	<b>LV429386</b>	<b>LV429406</b>
		220-240 V 50/60 Hz and 208-277 V 60 Hz	<b>LV429387</b>	<b>LV429407</b>
		380-415 V 50 Hz and 440-480 V 60 Hz	<b>LV429388</b>	<b>LV429408</b>
	525 V 50 Hz and 600 V 60 Hz	<b>LV429389</b>	<b>LV429409</b>	
DB111454.eps 	DC			
		12 V	<b>LV429382</b>	<b>LV429402</b>
		24 V	<b>LV429390</b>	<b>LV429410</b>
		30 V	<b>LV429391</b>	<b>LV429411</b>
		48 V	<b>LV429392</b>	<b>LV429412</b>
		60 V	<b>LV429383</b>	<b>LV429403</b>
		125 V	<b>LV429393</b>	<b>LV429413</b>
		250 V	<b>LV429394</b>	<b>LV429414</b>
		<b>MN 48 V 50/60 Hz with fixed time delay</b>		
	Composed of:	MN 48 V DC		<b>LV429412</b>
	Delay unit 48 V 50/60 Hz		<b>LV429426</b>	
	<b>MN 220-240 V 50/60 Hz with fixed time delay</b>			
Composed of:	MN 250 V DC		<b>LV429414</b>	
	Delay unit 220-240 V 50/60 Hz		<b>LV429427</b>	
	<b>MN 48 V DC/AC 50/60 Hz with adjustable time delay</b>			
Composed of:	MN 48 V DC		<b>LV429412</b>	
	Delay unit 48 V DC/AC 50/60 Hz		<b>33680</b>	
	<b>MN 110-130 V DC/AC 50/60 Hz with adjustable time delay</b>			
Composed of:	MN 125 V DC		<b>LV429413</b>	
	Delay unit 100-130 V DC/AC 50/60 Hz		<b>33681</b>	
	<b>MN 220-250 V DC/AC 50/60 Hz with adjustable time delay</b>			
Composed of:	MN 250 V DC		<b>LV429414</b>	
	Delay unit 200-250 V DC/AC 50-60 Hz		<b>33682</b>	

F



# Accessories and auxiliaries

## ComPact NSX100/160/250 with/without Vigi add-on

### Motor mechanism

#### Motor mechanism module supplied with SDE adapter

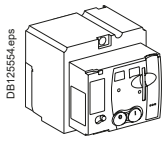
	AC	Voltage	MT100/160	MT250
		48-60 V 50/60 Hz	LV429440	LV431548
		110-130 V 50/60 Hz	LV429433	LV431540
		220-240 V 50/60 Hz and 208-277 V 60 Hz	LV429434	LV431541
		380-415 V 50/60 Hz and 440-480 V 60 Hz	LV429435	LV431542
	DC	24-30 V	LV429436	LV431543
		48-60 V	LV429437	LV431544
		110-130 V	LV429438	LV431545
		250 V	LV429439	LV431546

#### Communicating motor mechanism module supplied with SDE adapter

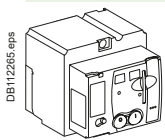
	Motor mechanism module	MTc 100/160	220-240 V 50/60 Hz	LV429441	
		MTc 250	220-240 V 50/60 Hz	LV431549	
	+	Breaker and Status Communication Module	BSCM		LV434205
	+	NSX cord	Wire length L = 0.35 m	LV434200	
			Wire length L = 1.3 m	LV434201	
			Wire length L = 3 m	LV434202	
			U > 480 V AC wire length L = 0.35 m	LV434204	



# Accessories and auxiliaries

## ComPact NSX100/160/250 with/without Vigi add-on

### Indication and measurement modules

#### PowerLogic PowerTag NSX

DB43062.eps

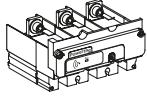

Rating (A)			250
3P			<b>LV434020</b>
3P+N			<b>LV434021</b>

#### Ammeter module

DB11256.eps

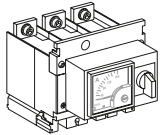

Rating (A)	100	160	250
3P	<b>LV429455</b>	<b>LV430555</b>	<b>LV431565</b>
4P	<b>LV429456</b>	<b>LV430556</b>	<b>LV431566</b>

#### I max. ammeter module

DB11256.eps

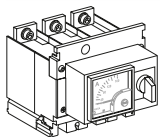

Rating (A)	100	160	250
3P	<b>LV434849</b>	<b>LV434850</b>	<b>LV434851</b>

#### Current transformer module

DB11257.eps

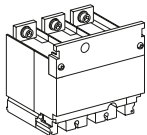

Rating (A)	100	150	250
3P	<b>LV429457</b>	<b>LV430557</b>	<b>LV431567</b>
4P	<b>LV429458</b>	<b>LV430558</b>	<b>LV431568</b>

#### Current transformer module and voltage output

DB11257.eps

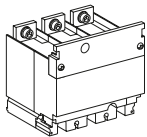

Rating (A)	125	150	250
3P	<b>LV429461</b>	<b>LV430561</b>	<b>LV431569</b>
4P	<b>LV429462</b>	<b>LV430562</b>	<b>LV431570</b>

#### Voltage presence indicator

DB11258.eps

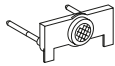

3P/4P		<b>LV429325</b>
-------	--	-----------------

### Rotary handles

#### Direct rotary handle

DB11259.eps

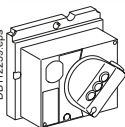

With black handle	<b>LV429337</b>
With red handle on yellow front	<b>LV429339</b>
MCC conversion accessory	<b>LV429341</b>
CNOMO conversion accessory	<b>LV429342</b>

#### Extended rotary handle

DB11260.eps

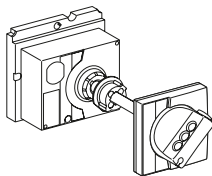

With black handle	<b>LV429338</b>
With red handle on yellow front	<b>LV429340</b>
With telescopic handle for withdrawable device	<b>LV429343</b>

DB421689.eps

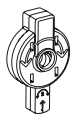

Open door shaft operator	<b>LV426937</b>
--------------------------	-----------------

#### Accessories for direct or extended rotary handle

Indication auxiliary	1 early-break contact	<b>LV429345</b>
	2 early-make contacts	<b>LV429346</b>

F

# Accessories and auxiliaries

## ComPact NSX100/160/250 with/without Vigi add-on

### Locks

#### Toggle locking device for 1 to 3 padlocks

DB425402.eps

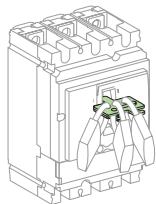

By removable device | 29370

DB425403.eps

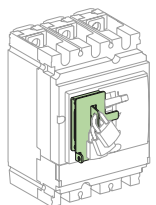

By fixed device for 3P-4P (open or close position) | LV429371

By fixed device for 3P-4P (open position only) | LV429370

#### Locking of rotary handle

DB425404.eps

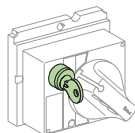

Keylock adapter (keylock not included) | LV429344

Keylock (keylock adapter not included) | 41940

Ronis 1351B.500

Profalux KS5 B24 D4Z | 42888

#### Locking of motor mechanism module

DB425405.eps

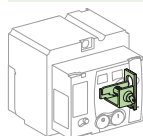

Keylock adapter + Ronis keylock (special) | LV429449



# Accessories and auxiliaries

## ComPact NSX100/160/250 with/without Vigi add-on

### Interlocking

#### Mechanical interlocking for circuit breakers

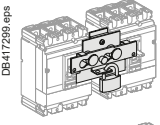
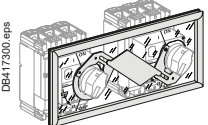

 <p>DB417299.eps</p>	With toggles	LV429354
	With rotary handles	LV429369
 <p>DB417300.eps</p>		

#### Interlocking with key (2 keylocks / 1 key) for rotary handles

 <p>DB425686.eps</p>	Keylock kit (keylock not included) <sup>[1]</sup>	LV429344	
	1 set of 2 keylocks	Ronis 1351B.500	41950
	(1 key only, keylock kit not included)	Profalux KS5 B24 D4Z	42878

### Installation accessories

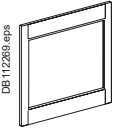
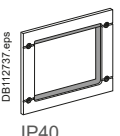
#### Front-panel escutcheons

 <p>DB112269.eps</p> <p>IP30</p>	IP30 escutcheon for all control types	LV429525
	IP30 trip unit access escutcheon for toggle	LV429526
	IP30 escutcheon for Vigi add-on	LV429527
 <p>DB112737.eps</p> <p>IP40</p>	IP40 escutcheon for all control types	LV429317
	IP40 escutcheon for Vigi add-on	LV429316
	IP40 escutcheon for Vigi add-on or ammeter module	LV429318
<h4>IP43 rubber toggle cover</h4>		
 <p>DB112738.eps</p>	1 toggle cover	LV429319

#### Lead-sealing accessories

 <p>DB115615.eps</p>	Bag of accessories	LV429375
--	--------------------	----------

#### Din rail adapter

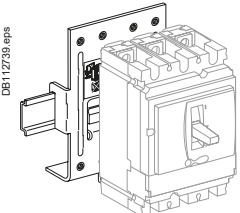
 <p>DB112739.eps</p>	1 adapter	LV429305
--	-----------	----------

#### 60 mm plate

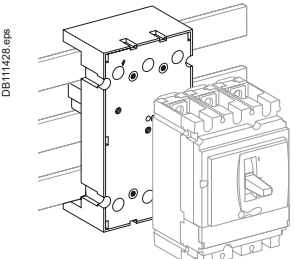
 <p>DB111428.eps</p>	Plate 3P ComPact NSX100/250 IEC	LV429372
	Plate 4P ComPact NSX100/250 IEC	LV429373

[1] For only 1 device.

# Accessories and auxiliaries

## ComPact NSX100/160/250 with/without Vigi add-on

### Plug-in/withdrawable version accessories

#### Insulation accessories

DB117159.eps 	1 connection adapter for plug-in base	3P	LV429306
		4P	LV429307

#### Auxiliary connections

DB117160.eps 	1 9-wire fixed connector (for base)		LV429273
---	-------------------------------------	--	----------

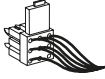
DB117161.eps 	1 9-wire moving connector (for circuit breaker)		LV429274
---	---	--	----------

DB117162.eps 	1 support for 2 moving connectors		LV429275
---	-----------------------------------	--	----------

DB115855.eps 	9-wire manual auxiliary connector (fixed + moving)		LV429272
---	--	--	----------

#### Plug-in base accessories

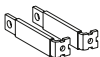
DB43265.eps 	2 long insulated right angle terminal extensions	Set of 2	LV429276
--	--	----------	----------

DB117165.eps 	2 IP40 shutters for base		LV429271
---	--------------------------	--	----------

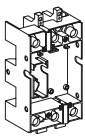
DB117166.eps 	Base	2P (3P base)	LV429265
		3P	LV429266

DB117167.eps 	Base	4P	LV429267
---	------	----	----------

DB117168.eps 	2 power connections	2/3/4P	LV429268
---	---------------------	--------	----------

DB117169.eps 	1 short terminal shield	2/3P	LV429515
---	-------------------------	------	----------

DB117170.eps 	1 short terminal shield	4P	LV429516
---	-------------------------	----	----------

DB117171.eps 	1 safety trip interlock	2/3/4P	LV429270
---	-------------------------	--------	----------

#### Chassis accessories

DB117172.eps 	Escutcheon collar	Toggle	LV429284
---	-------------------	--------	----------

DB117173.eps 	Escutcheon collar	Vigi add-on	LV429285
---	-------------------	-------------	----------

DB117163.eps 	Locking kit (keylock not included)		LV429286
---	------------------------------------	--	----------





DB11426.eps 	Keylock (keylock adapter not included)	Ronis 1351B.500	41940
		Profalux KS5 B24 D4Z	42888

DB11426.eps 	2 carriage switches (connected/disconnected position indication)		LV429287
--	--	--	----------

# Accessories and auxiliaries

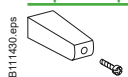
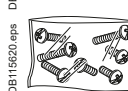
## ComPact NSX100/160/250 with/without Vigi add-on

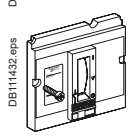
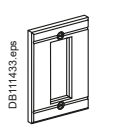
### Spare parts

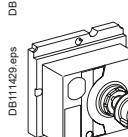
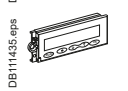
	5 spare toggle extensions (NSX250)		<b>LV429313</b>
	Bag of screws		<b>LV429312</b>
	12 snap-in nuts (fixed/FC)	M6 for NSX100N/H/L M8 for NSX160/250N/H/L	<b>LV429234</b> <b>LV430554</b>
	NS retrofit escutcheon	Small cut-out	<b>LV429528</b>
	IP40 toggle escutcheon	ComPact NS type/small cut-out	<b>29315</b>
	1 set of 10 identification labels		<b>LV429226</b>
	1 base for extended rotary handle		<b>LV429502</b>
	Torque limiting screws (set of 12)	3P/4P ComPact NSX100-250	<b>LV429513</b>
	LCD display for electronic trip unit	MicroLogic 5 MicroLogic 6 MicroLogic 6 E-M	<b>LV429483</b> <b>LV429484</b> <b>LV429486</b>
	5 transparent covers for trip unit	TM, MA, NA MicroLogic 2 MicroLogic 5/6	<b>LV429481</b> <b>LV429481</b> <b>LV429478</b>

### Individual enclosures

#### IP55 steel enclosure

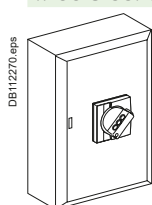
	ComPact NSX100/160 with black extended rotary handle	<b>LV431215</b>
	ComPact NSX100/160 with red and yellow extended rotary handle	<b>LV431216</b>
	ComPact NSX250 or ComPact NSX100-250 Vigi add-on with black extended rotary handle	<b>LV431217</b>
	ComPact NSX250 or ComPact NSX100-250 Vigi add-on with red and yellow extended rotary handle	<b>LV431218</b>

#### IP55 insulating enclosure

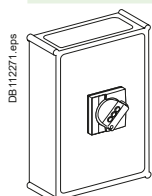
	ComPact NSX100/160 with black extended rotary handle	<b>LV429465</b>
	ComPact NSX100/160 Vigi add-on with black extended rotary handle	<b>LV429466</b>
	ComPact NSX250 with black extended rotary handle	<b>LV431573</b>
	ComPact NSX250 Vigi add-on with black extended rotary handle	<b>LV431574</b>

### Visible break disconnect function

See catalog dealing with "ComPact INV products (visible break)" and the associated accessories.  
The visible break disconnection function is compatible with fixed front-connected/rear-connected ComPact NSX devices.

# Accessories and auxiliaries

## ComPact NSX100/160/250 with/without Vigi add-on

### Communication option

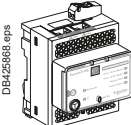
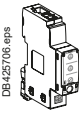
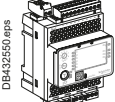
 DB426888 eps	IFE	Ethernet interface for LV breaker	LV434001
		Ethernet interface for LV breakers and gateway	LV434002
 DB425706 eps	IFM Modbus-SL interface module		LV434000
 DB432550 eps	I/O application module		LV434063
	User guide IFE		DOCA0084EN
	User guide I/O application module		DOCA0055EN

### Monitoring and control (remote operation)

#### Circuit breaker accessories

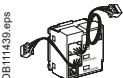
 DB111439 eps	Breaker Status Control Module	BSCM <sup>[1]</sup>	LV434205
--	-------------------------------	---------------------	----------



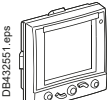



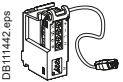

#### ULP display module<sup>[2]</sup>

 DB433551 eps	Switchboard front display module FDM121		TRV00121
	FDM mounting accessory (diameter 22 mm)		TRV00128

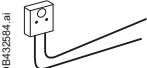
#### Ethernet display module

 DB417489 eps	Switchboard front display module FDM128		LV434128
--	---	--	----------

#### ULP wiring accessories

 DB111442 eps	NSX cord L = 0.35 m		LV434200
	NSX cord L = 1.3 m		LV434201
	NSX cord L = 3 m		LV434202
	NSX cord for U > 480 V AC L = 1.3 m		LV434204
 DB113621 eps	10 stacking connectors for communication interface modules		TRV00217
 DB432684 al	2 Modbus line terminators		VW3A8306DRC <sup>[3]</sup>
 LV434211 al	Connector Modbus adaptor		LV434211
 DB417490 eps	RS 485 roll cable (4 wires, length 60 m)		50965
 DB115823 eps	5 RJ45 connectors female/female		TRV00870
 DB111444 eps	10 ULP line terminators		TRV00880
 DB111445 eps	10 RJ45/RJ45 male cord L = 0.3 m		TRV00803
	10 RJ45/RJ45 male cord L = 0.6 m		TRV00806
	5 RJ45/RJ45 male cord L = 1 m		TRV00810
	5 RJ45/RJ45 male cord L = 2 m		TRV00820
	5 RJ45/RJ45 male cord L = 3 m		TRV00830
	1 RJ45/RJ45 male cord L = 5 m		TRV00850

[1] SDE adapter mandatory for trip unit TM, MA or MicroLogic 2 (LV429451).





[2] For measurement display with MicroLogic A and E or status display with BSCM.

[3] www.schneider-electric.com.

# Accessories and auxiliaries

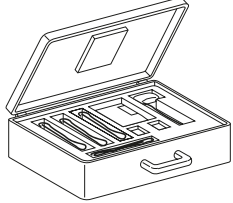
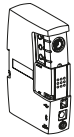
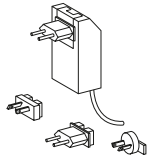
## ComPact NSX100/160/250 with/without Vigi add-on

### Test tool, software, demo

Test tool		
	Pocket battery for MicroLogic NSX100-630	LV434206
	Maintenance case Comprising: - USB maintenance interface - Power supply - MicroLogic cord - USB cord - RJ45/RJ45 male cord	TRV00910
	Spare USB maintenance interface	TRV00911
	Spare power supply 110-240 V AC	TRV00915
	Spare MicroLogic cord for USB maintenance interface	TRV00917
	Bluetooth/Modbus option for USB maintenance interface	VW3A8114 <sup>[1]</sup>
Software		
	Configuration and setting EcoStruxure Power Commission software	LV4ST100 <sup>[2]</sup>
	Test software LTU	LV4ST121 <sup>[2]</sup>
	Monitoring EcoStruxure Power Commission software	LV4SM100 <sup>[2]</sup>
Demo tool		
	Demo case for ComPact NSX	LV434207

[1] See Telemecanique catalog.

[2] Downloadable from <http://schneider-electric.com>.



# Accessories and auxiliaries

## ComPact NSX100/160/250 with/without Vigi add-on

### Accessories

#### Power supply modules

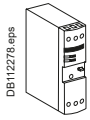

External power supply module 100-240 V AC 110-230 V DC / 24 V DC-3 A class 2	<b>ABL8RPS24030</b>	[1]
--	---------------------	-----

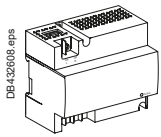

External power supply module 24 V DC-1 A OVC IV		
24-30 V DC	<b>LV454440</b>	
48-60 V DC	<b>LV454441</b>	
100-125 V DC	<b>LV454442</b>	
110-130 V AC	<b>LV454443</b>	
200-240 V AC	<b>LV454444</b>	

#### Battery module

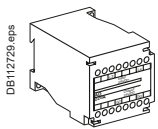

24 V DC battery module	<b>54446</b>	
------------------------	--------------	--

[1] See Telemecanique catalog.





F

# Catalog numbers: ComPact NSX400-630

## Complete fixed device

ComPact NSX400/630F (36 kA 380/415 V).....	F-52
ComPact NSX400/630F Vigi add-on (36 kA 380/415 V) .....	F-53
ComPact NSX400/630N (50 kA 380/415 V) .....	F-54
ComPact NSX400/630N Vigi add-on (50 kA 380/415 V) .....	F-55
ComPact NSX400/630H (70 kA 380/415 V) .....	F-56
ComPact NSX400/630R (200 kA 380/415 V - 45 kA 690 V).....	F-57
ComPact NSX400/630HB1 (85 kA 500 V - 75 kA 690 V) .....	F-58
ComPact NSX400/630HB2 (85 kA 500 V - 100 kA 690 V) .....	F-59
ComPact NSX400/630NA .....	F-60

## Based on separate components

ComPact NSX and ComPact NSX Vigi add-on .....	F-61
---	------

## Trip unit accessories

ComPact NSX400/630 with/without Vigi add-on .....	F-63
---	------

## Installation and connection

ComPact NSX and ComPact NSX400/630 Vigi add-on .....	F-64
ComPact NSX400/630 with/without Vigi add-on .....	F-66

## Communication, monitoring and control

ComPact NSX400/630 with/without Vigi add-on .....	F-74
---	------

## Monitoring and control, accessories

ComPact NSX400/630 with/without Vigi add-on .....	F-75
---	------

## Source-changeover systems for 2 devices

ComPact NSX100 to NSX630 .....	F-76
--------------------------------	------

## NSX100/400 for utilities,

"tarif jaune" public distribution .....	F-78
---	------

ComPact NSX100 to NSX630 order form.....	F-82
--	------



### Other chapters

Select your circuit breakers and switch-disconnectors .....	A-1
Select your protection .....	B-1
Customize your circuit breaker with accessories .....	C-1
Smart Panel integration .....	D-1
Switchboard integration .....	E-1
Glossary .....	G-1
Additional characteristics .....	H-1

# Complete fixed device

## ComPact NSX400/630F (36 kA 380/415 V)

### ComPact NSX400/630F

#### Electronic trip unit MicroLogic 2.3 (LS<sub>o</sub>I protection)

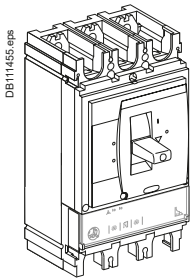

		3P 3d	4P 3d, 4d, 3d + N/2
ComPact NSX400F (36 kA at 380/415 V)	250 A	LV432682	LV432683
	400 A	LV432676	LV432677
ComPact NSX630F (36 kA at 380/415 V)	630 A	LV432876	LV432877

#### Electronic trip unit MicroLogic Vigi 4.3 (LS<sub>o</sub>IR protection)

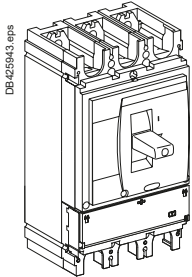

		3P 3d	4P 4d 3d + N/2
ComPact NSX400F (36 kA at 380/415 V)	400 A	LV433934	LV433936
ComPact NSX400F (36 kA at 380/415 V)	570 A	LV433935	LV433937

#### Electronic trip unit MicroLogic 5.3 A (LSI protection, ammeter)

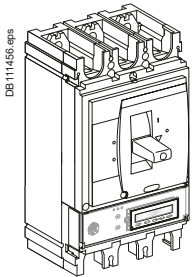

		3P 3d	4P 3d, 4d, 3d + N/2, 3d + OSN
ComPact NSX400F (36 kA at 380/415 V)	400 A	LV432678	LV432679
ComPact NSX630F (36 kA at 380/415 V)	630 A	LV432878	LV432879

#### Electronic trip unit MicroLogic 1.3 M (I motor protection)

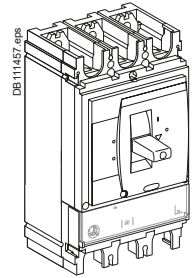

		3P 3d
ComPact NSX400F 1.3 M (36 kA at 380/415V)	320 A	LV432748
ComPact NSX630F 1.3 M (36 kA at 380/415V)	500 A	LV432948

#### Electronic trip unit MicroLogic 2.3 M (LS<sub>o</sub>I motor protection)

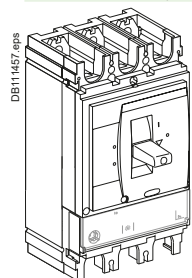

		3P 3d
ComPact NSX400F 2.3 M (36 kA at 380/415V)	320 A	LV432775
ComPact NSX630F 2.3 M (36 kA at 380/415V)	500 A	LV432975

With electronic trip unit MicroLogic 5.3 E (LSI protection, energy meter)

To be ordered with 2 catalog numbers: 1 basic frame + 1 trip unit

With electronic trip unit MicroLogic 6.3 A (LSIG protection, ammeter)

To be ordered with 2 catalog numbers: 1 basic frame + 1 trip unit

With electronic trip unit MicroLogic 6.3 E (LSIG protection, energy meter)

To be ordered with 2 catalog numbers: 1 basic frame + 1 trip unit

With electronic trip unit MicroLogic 6.3 E-M (LSIG motor protection, energy meter)

To be ordered with 2 catalog numbers: 1 basic frame + 1 trip unit

F

# Complete fixed device

## ComPact NSX400/630F Vigi add-on (36 kA 380/415 V)

### ComPact NSX400/630F Vigi add-on

Electronic trip unit MicroLogic 2.3 (LS<sub>0</sub>I protection)

DB111458.eps

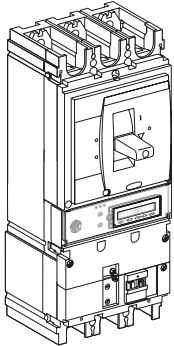

		<b>3P 3d</b>	<b>4P 3d, 4d, 3d + N/2</b>
ComPact NSX400F Vigi add-on (36 kA at 380/415 V)	400 A	<b>LV432731</b>	<b>LV432732</b>
ComPact NSX630F Vigi add-on (36 kA at 380/415 V)	630 A	<b>LV432931</b>	<b>LV432932</b>

With electronic trip unit MicroLogic 5.3 E (LSI protection, energy meter)

To be ordered with 2 catalog numbers: 1 basic frame + 1 trip unit

With electronic trip unit MicroLogic 6.3 A (LSIG protection, ammeter)

To be ordered with 2 catalog numbers: 1 basic frame + 1 trip unit

With electronic trip unit MicroLogic 6.3 E (LSIG protection, energy meter)

To be ordered with 2 catalog numbers: 1 basic frame + 1 trip unit

With electronic trip unit MicroLogic 6.3 E-M (LSIG motor protection, energy meter)

To be ordered with 2 catalog numbers: 1 basic frame + 1 trip unit

# Complete fixed device

## ComPact NSX400/630N (50 kA 380/415 V)

### ComPact NSX400/630N

#### Electronic trip unit MicroLogic 2.3 (LS<sub>o</sub>I protection)

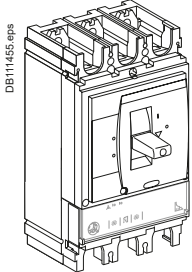

		3P 3d	4P 3d, 4d, 3d + N/2
ComPact NSX400N (50 kA at 380/415 V)	250 A	LV432707	LV432708
	400 A	LV432693	LV432694
ComPact NSX630N (50 kA at 380/415 V)	630 A	LV432893	LV432894

#### Electronic trip unit MicroLogic Vigi 4.3 (LS<sub>o</sub>IR protection)

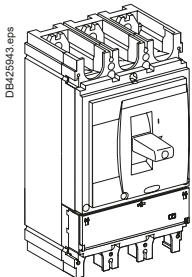

		3P 3d	4P 4d 3d + N/2
ComPact NSX400N (50 kA at 380/415 V)	400 A	LV433938	LV433940
ComPact NSX630N (50 kA at 380/415 V)	570 A	LV433939	LV433941

#### Electronic trip unit MicroLogic 5.3 A (LSI protection, ammeter)

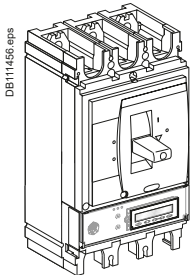

		3P 3d	4P 3d, 4d, 3d + N/2, 3d + OSN
ComPact NSX400N (50 kA at 380/415 V)	400 A	LV432699	LV432700
ComPact NSX630N (50 kA at 380/415 V)	630 A	LV432899	LV432900

#### Electronic trip unit MicroLogic 1.3 M A (I motor protection)

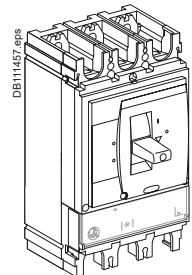

		3P 3d
ComPact NSX400N 1.3 M (50 kA at 380/415V)	320 A	LV432749
ComPact NSX630N 1.3 M (50 kA at 380/415V)	500 A	LV432949

#### Electronic trip unit MicroLogic 2.3 M (LS<sub>o</sub>I motor protection)

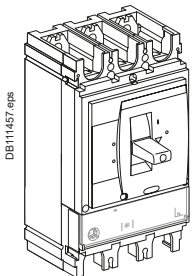

		3P 3d
ComPact NSX400N 2.3 M (50 kA at 380/415V)	320 A	LV432776
ComPact NSX630N 2.3 M (50 kA at 380/415V)	500 A	LV432976

F

# Complete fixed device

## ComPact NSX400/630N Vigi add-on (50 kA 380/415 V)

### ComPact NSX400/630N Vigi add-on

Electronic trip unit MicroLogic 2.3 (LS<sub>0</sub>I protection)

DB111458.eps

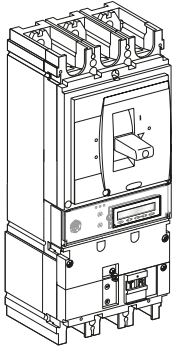

		<b>3P 3d</b>	<b>4P 3d, 4d, 3d + N/2</b>
ComPact NSX400N Vigi add-on (50 kA at 380/415 V) 400 A		<b>LV432733</b>	<b>LV432734</b>
ComPact NSX630N Vigi add-on (50 kA at 380/415 V) 630 A		<b>LV432933</b>	<b>LV432934</b>

With electronic trip unit MicroLogic 5.3 E (LSI protection, energy meter)

To be ordered with 2 catalog numbers: 1 basic frame + 1 trip unit



# Complete fixed device

## ComPact NSX400/630H (70 kA 380/415 V)

### ComPact NSX400/630H

Electronic trip unit MicroLogic 2.3 (LS<sub>o</sub>I protection)

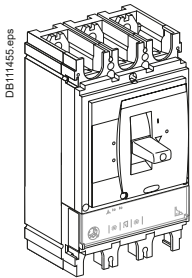

		3P 3d	4P 3d, 4d, 3d + N/2
ComPact NSX400H (70 kA at 380/415 V)	250 A	LV432709	LV432710
	400 A	LV432695	LV432696
ComPact NSX630H (70 kA at 380/415 V)	630 A	LV432895	LV432896

Electronic trip unit MicroLogic Vigi 4.3 (LS<sub>o</sub>IR protection)

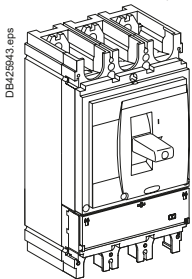

		3P 3d	4P 4d 3d + N/2
ComPact NSX400H (70 kA at 380/415 V)	400 A	LV433942	LV433944
ComPact NSX630H (70 kA at 380/415 V)	570 A	LV433943	LV433945

Electronic trip unit MicroLogic 5.3 A (LSI protection, ammeter)

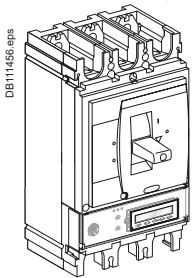

		3P 3d	4P 3d, 4d, 3d + N/2, 3d + OSN
ComPact NSX400H (70 kA at 380/415 V)	400 A	LV432701	LV432702
ComPact NSX630H (70 kA at 380/415 V)	630 A	LV432901	LV432902

Electronic trip unit MicroLogic 1.3 M (I motor protection)

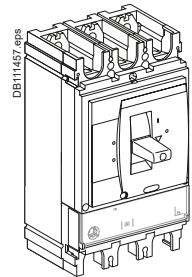

		3P 3d
ComPact NSX400H 1.3 M (70 kA at 380/415V)	320 A	LV432750
ComPact NSX630H 1.3 M (70 kA at 380/415V)	500 A	LV432950

Electronic trip unit MicroLogic 2.3 M (LS<sub>o</sub>I motor protection)

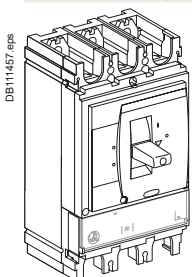

		3P 3d
ComPact NSX400H 2.3 M (70 kA at 380/415V)	320 A	LV432777
ComPact NSX630H 2.3 M (70 kA at 380/415V)	500 A	LV432977

With electronic trip unit MicroLogic 6.3 E (LSIG protection, energy meter)

Only available as separate components.

With electronic trip unit MicroLogic 6.3 E-M (LSIG motor protection, energy meter)

Only available as separate components.



# Complete fixed device

## ComPact NSX400/630R (200 kA 380/415 V - 45 kA 690 V)

### ComPact NSX400/630R

#### Electronic trip unit MicroLogic 2.3 (LS<sub>0</sub>I protection)

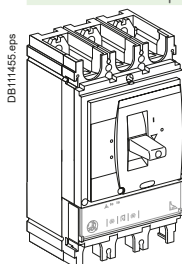

DB11455.eps		NSX400R (200 kA at 380/415 V - 45 kA at 690 V)	250 A	<b>3P 3d</b>	<b>4P 3d, 4d, 3d + N/2</b>
			400 A	<b>LV433600</b>	<b>LV433601</b>
		NSX630R (200 kA at 380/415 V - 45 kA at 690 V)	630 A	<b>LV433602</b>	<b>LV433603</b>
				<b>LV433700</b>	<b>LV433701</b>

#### Electronic trip unit MicroLogic 5.3 E (LSI protection, energy meter)

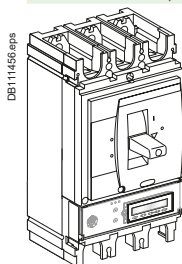

DB11456.eps		NSX400R (200 kA at 380/415 V - 45 kA at 690 V)	400 A	<b>3P 3d</b>	<b>4P 3d, 4d, 3d + N/2, 3d + OSN</b>
			630 A	<b>LV433606</b>	<b>LV433607</b>
		NSX630R (200 kA at 380/415 V - 45 kA at 690 V)	630 A	<b>LV433704</b>	<b>LV433705</b>

#### Electronic trip unit MicroLogic 6.3 E (LSIG protection, energy meter)

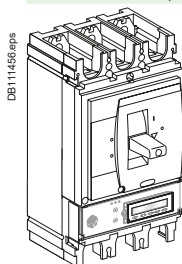

DB11456.eps		NSX400R (200 kA at 380/415 V - 45 kA at 690 V)	400 A	<b>3P 3d</b>	<b>4P 3d, 4d, 3d + N/2, 3d + OSN</b>
			630 A	<b>LV433608</b>	<b>LV433609</b>
		NSX630R (200 kA at 380/415 V - 45 kA at 690 V)	630 A	<b>LV433706</b>	<b>LV433707</b>

#### Electronic trip unit MicroLogic 1.3 M (I motor protection)

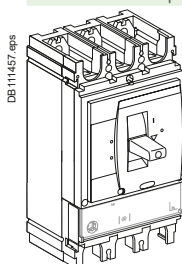

DB11457.eps		NSX400R (200 kA at 380/415 V - 45 kA at 690 V)	320 A	<b>3P 3d</b>	
			500 A	<b>LV433604</b>	
		NSX630R (200 kA at 380/415 V - 45 kA at 690 V)	500 A	<b>LV433702</b>	

#### Electronic trip unit MicroLogic 2.3 M (LS<sub>0</sub>I motor protection)

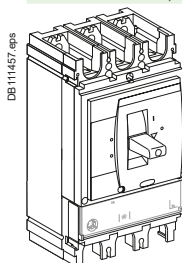

DB11457.eps		NSX400R (200 kA at 380/415 V - 45 kA at 690 V)	320 A	<b>3P 3d</b>	
			500 A	<b>LV433605</b>	
		NSX630R (200 kA at 380/415 V - 45 kA at 690 V)	500 A	<b>LV433703</b>	

#### With electronic trip unit MicroLogic 6.3 E-M (LSIG motor protection, energy meter)

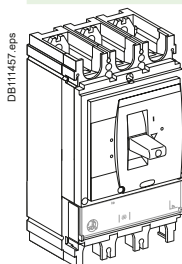

DB11457.eps		NSX400R (200 kA at 380/415 V - 45 kA at 690 V)	320 A	<b>3P 3d</b>	
			500 A	<b>LV433610</b>	
		NSX630R (200 kA at 380/415 V - 45 kA at 690 V)	500 A	<b>LV433703</b>	



# Complete fixed device

## ComPact NSX400/630HB1 (85 kA 500 V - 75 kA 690 V)

### ComPact NSX400/630HB1

#### Electronic trip unit MicroLogic 2.3 (LS<sub>0</sub>I protection)

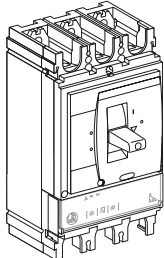
	NSX400HB1 (85 kA at 500 V - 75 kA at 690 V)	250 A	<b>3P 3d</b>	<b>4P 3d, 4d, 3d + N/2</b>
		400 A	<b>LV433620</b>	<b>LV433621</b>
	NSX630HB1 (85 kA at 500 V - 75 kA at 690 V)	400 A	<b>LV433622</b>	<b>LV433623</b>
		630 A	<b>LV433720</b>	<b>LV433721</b>

#### Electronic trip unit MicroLogic 5.3 E (LSI protection, energy meter)

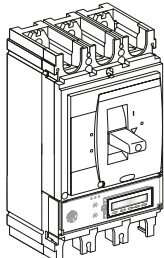
	NSX400HB1 (85 kA at 500 V - 75 kA at 690 V)	400 A	<b>3P 3d</b>	<b>4P 3d, 4d, 3d + N/2, 3d + OSN</b>
		630 A	<b>LV433626</b>	<b>LV433627</b>
	NSX630HB1 (85 kA at 500 V - 75 kA at 690 V)	630 A	<b>LV433724</b>	<b>LV433725</b>

#### Electronic trip unit MicroLogic 6.3 E (LSIG protection, energy meter)

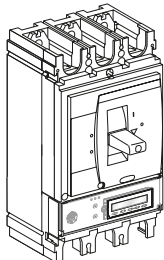
	NSX400HB1 (85 kA at 500 V - 75 kA at 690 V)	400 A	<b>3P 3d</b>	<b>4P 3d, 4d, 3d + N/2, 3d + OSN</b>
		630 A	<b>LV433628</b>	<b>LV433629</b>
	NSX630HB1 (85 kA at 500 V - 75 kA at 690 V)	630 A	<b>LV433726</b>	<b>LV433727</b>

#### Electronic trip unit MicroLogic 1.3 M (I motor protection)

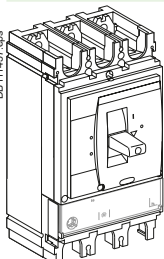
	NSX400HB1 (85 kA at 500 V - 75 kA at 690 V)	320 A	<b>3P 3d</b>
		500 A	<b>LV433624</b>
	NSX630HB1 (85 kA at 500 V - 75 kA at 690 V)	500 A	<b>LV433722</b>

#### Electronic trip unit MicroLogic 2.3 M (LS<sub>0</sub>I motor protection)

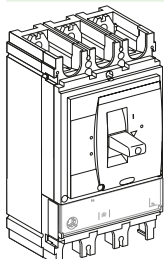
	NSX400HB1 (85 kA at 500 V - 75 kA at 690 V)	320 A	<b>3P 3d</b>
		500 A	<b>LV433625</b>
	NSX630HB1 (85 kA at 500 V - 75 kA at 690 V)	500 A	<b>LV433723</b>

#### With electronic trip unit MicroLogic 6.3 E-M (LSIG motor protection, energy meter)

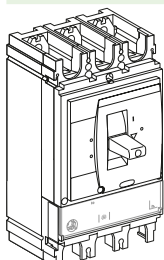
	NSX400HB1 (85 kA at 500 V - 75 kA at 690 V)	320 A	<b>3P 3d</b>
		500 A	<b>LV433630</b>
	NSX630HB1 (85 kA at 500 V - 75 kA at 690 V)	500 A	<b>LV433728</b>

F

# Complete fixed device

## ComPact NSX400/630HB2 (85 kA 500 V - 100 kA 690 V)

### ComPact NSX400/630HB2

#### Electronic trip unit MicroLogic 2.3 (LS<sub>0</sub>I protection)

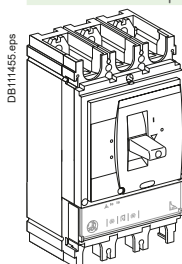

NSX400HB2 (85 kA at 500 V - 100 kA at 690 V)	250 A	<b>3P 3d</b>	<b>4P 3d, 4d, 3d + N/2</b>
	400 A	<b>LV433640</b>	<b>LV433641</b>
NSX630HB2 (85 kA at 500 V - 100 kA at 690 V)	630 A	<b>LV433642</b>	<b>LV433643</b>
		<b>LV433740</b>	<b>LV433741</b>

#### Electronic trip unit MicroLogic 5.3 E (LSI protection, energy meter)

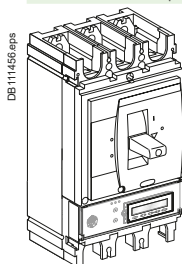

NSX400HB2 (85 kA at 500 V - 100 kA at 690 V)	400 A	<b>3P 3d</b>	<b>4P 3d, 4d, 3d + N/2, 3d + OSN</b>
		<b>LV433646</b>	<b>LV433647</b>
NSX630HB2 (85 kA at 500 V - 100 kA at 690 V)	630 A	<b>LV433744</b>	<b>LV433745</b>

#### Electronic trip unit MicroLogic 6.3 E (LSIG protection, energy meter)

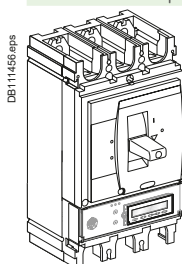

NSX400HB2 (85 kA at 500 V - 100 kA at 690 V)	400 A	<b>3P 3d</b>	<b>4P 3d, 4d, 3d + N/2, 3d + OSN</b>
		<b>LV433648</b>	<b>LV433649</b>
NSX630HB2 (85 kA at 500 V - 100 kA at 690 V)	630 A	<b>LV433746</b>	<b>LV433747</b>

#### Electronic trip unit MicroLogic 1.3 M (I motor protection)

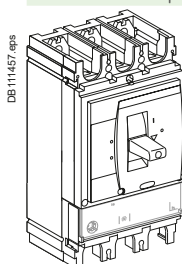

NSX400HB2 (85 kA at 500 V - 100 kA at 690 V)	320 A	<b>3P 3d</b>	
		<b>LV433644</b>	
NSX630HB2 (85 kA at 500 V - 100 kA at 690 V)	500 A	<b>LV433742</b>	

#### Electronic trip unit MicroLogic 2.3 M (LS<sub>0</sub>I motor protection)

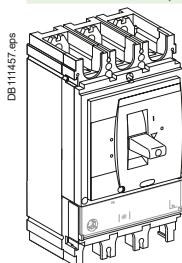

NSX400HB2 (85 kA at 500 V - 100 kA at 690 V)	320 A	<b>3P 3d</b>	
		<b>LV433645</b>	
NSX630HB2 (85 kA at 500 V - 100 kA at 690 V)	500 A	<b>LV433743</b>	

#### With electronic trip unit MicroLogic 6.3 E-M (LSIG motor protection, energy meter)

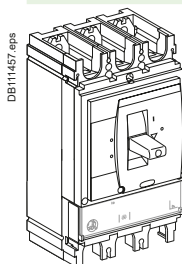

NSX400HB2 (85 kA at 500 V - 100 kA at 690 V)	320 A	<b>3P 3d</b>	
		<b>LV433650</b>	
NSX630HB2 (85 kA at 500 V - 100 kA at 690 V)	500 A	<b>LV433748</b>	



# Complete fixed device ComPact NSX400/630NA

## ComPact NSX400/630 NA switch-disconnector

With NA switch-disconnector unit

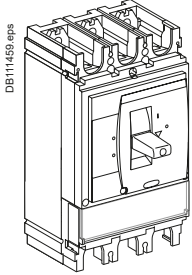

	3P	4P
ComPact NSX400 NA	LV432756	LV432757
ComPact NSX630 NA, 45 mm pitch	LV432956	LV432957

# Based on separate components

## ComPact NSX and ComPact NSX Vigi add-on

### Basic frame

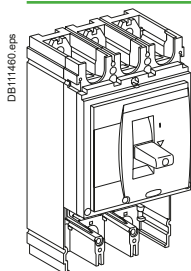

DB11460.eps

#### ComPact NSX400

	3P	4P
NSX400F (36 kA 380/415 V)	LV432413	LV432415
NSX400N (50 kA 380/415 V)	LV432403	LV432408
NSX400H (70 kA 380/415 V)	LV432404	LV432409
NSX400S (100 kA 380/415 V)	LV432414	LV432416
NSX400L (150 kA 380/415 V)	LV432405	LV432410

#### ComPact NSX630

	3P	4P
NSX630F (36 kA 380/415 V)	LV432813	LV432815
NSX630N (50 kA 380/415 V)	LV432803	LV432808
NSX630H (70 kA 380/415 V)	LV432804	LV432809
NSX630S (100 kA 380/415 V)	LV432814	LV432816
NSX630L (150 kA 380/415 V)	LV432805	LV432810

### + Trip unit

#### Distribution protection

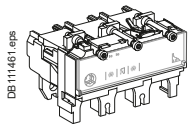

DB11461.eps

#### MicroLogic 2.3 (LS<sub>0</sub>I protection)

Rating	3P 3d	4P 3d, 4d, 3d + N/2
MicroLogic 2.3 250 A	LV432082	LV432086
MicroLogic 2.3 400 A	LV432081	LV432085
MicroLogic 2.3 630 A	LV432080	LV432084

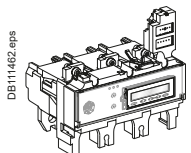

DB11462.eps

#### MicroLogic 5.3 A (LSI protection, ammeter)

Rating	3P 3d	4P 3d, 4d, 3d + N/2, 3d + OSN
MicroLogic 5.3 A 400 A	LV432091	LV432094
MicroLogic 5.3 A 630 A	LV432090	LV432093

#### MicroLogic 5.3 E (LSI protection, energy meter)

Rating	3P 3d	4P 3d, 4d, 3d + N/2, 3d + OSN
MicroLogic 5.3 E 400 A	LV432097	LV432100
MicroLogic 5.3 E 630 A	LV432096	LV432099

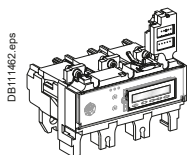

DB11462.eps

#### MicroLogic 6.3 A (LSIG protection, ammeter)

Rating	3P 3d	4P 3d, 4d, 3d + N/2, 3d + OSN
MicroLogic 6.3 A 400 A	LV432103	LV432106
MicroLogic 6.3 A 630 A	LV432102	LV432105

#### MicroLogic 6.3 E (LSIG protection, energy meter)

Rating	3P 3d	4P 3d, 4d, 3d + N/2, 3d + OSN
MicroLogic 6.3 E 400 A	LV432109	LV432112
MicroLogic 6.3 E 630 A	LV432108	LV432111

#### Distribution protection with embedded earth leakage protection

#### With electronic trip unit MicroLogic Vigi 4.3 (LS<sub>0</sub>IR protection)

Rating	3P 3d	4P 4d 3d + N/2
400 A	LV433930	LV433932
570 A	LV433931	LV433933

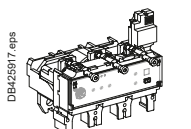

DB425917.eps

#### With electronic trip unit MicroLogic Vigi 7.3 E (LSIR protection)

Rating	3P 3d	4P 4d 3d + N/2
400 A	LV433950	LV433952
570 A	LV433951	LV433953

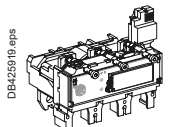

DB425918.eps

#### Distribution protection with embedded earth leakage protection alarm

#### With electronic trip unit MicroLogic Vigi 4.3 AL (LS<sub>0</sub>I protection + earth leakage alarm)

Rating	3P 3d	4P 4d 3d + N/2
400 A	LV433960	LV433962
570 A	LV433961	LV433963

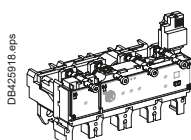

DB425919.eps

#### With electronic trip unit MicroLogic Vigi 7.3 E AL (LSI protection + earth leakage alarm)

Rating	3P 3d	4P 4d 3d + N/2
400 A	LV433965	LV433967
570 A	LV433966	LV433968

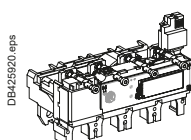

DB425920.eps

F

# Based on separate components

## ComPact NSX400/630

### + Trip unit

#### Motor protection

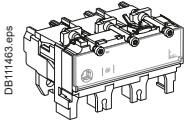

#### MicroLogic 1.3 M (I protection)

Rating	<b>3P 3d</b>	<b>4P 3d</b>
MicroLogic 1.3 M 320 A	<b>LV432069</b>	<b>LV432078</b>
MicroLogic 1.3 M 500 A	<b>LV432068</b>	<b>LV432077</b>

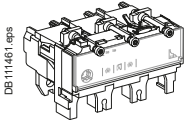

#### MicroLogic 2.3 M (LS<sub>0</sub>I protection)

Rating	<b>3P 3d</b>	
MicroLogic 2.3 M 320 A	<b>LV432072</b>	
MicroLogic 2.3 M 500 A	<b>LV432071</b>	

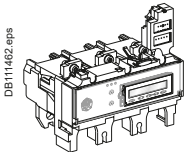

#### MicroLogic 6.3 E-M (LSIG protection, energy meter)

Rating	<b>3P 3d</b>	
MicroLogic 6.3 E-M 320 A	<b>LV432075</b>	
MicroLogic 6.3 E-M 500 A	<b>LV432074</b>	

#### Protection of public distribution systems

#### MicroLogic 2.3 AB (LS<sub>0</sub>I protection)

Rating		<b>4P 3d, 4d, 3d + N/2</b>
MicroLogic 2.3 400 A		<b>LV434557</b>

#### 16 Hz 2/3 network protection

#### MicroLogic 5.3 A-Z (LSI protection, ammeter)

Rating	<b>3P 3d</b>	
MicroLogic 5.3 A-Z 630 A	<b>LV432089</b>	

#### Earth Leakage protection of public distribution systems

#### MicroLogic Vigi 4.3 AB distribution protections

Rating		<b>4P 4d 3d + N/2</b>
400 A		<b>LV433948</b>

### + Vigi add-on or Vigi add-on Alarm

#### Vigi add-on

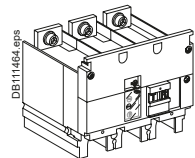

Type MB	200 to 440 V	<b>3P</b>	<b>4P</b>
	440 to 550 V	<b>LV432455</b>	<b>LV432456</b>
Connection for a 4P Vigi add-on on a 3P breaker		<b>LV432453</b>	<b>LV432454</b>
			<b>LV432457</b>

#### Vigi add-on Alarm

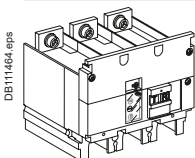

200 to 440 V AC	<b>3P</b>	<b>4P</b>
Connection for a 4P insulation monitoring module on a 3P breaker	<b>LV432659</b>	<b>LV432660</b>
		<b>LV432457</b>

F

# Trip unit accessories

## ComPact NSX400/630 with/without Vigi add-on

### Trip unit accessories

External neutral CT for 3 pole breaker with MicroLogic 5/6

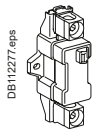

400-630 A LV432575

24 V DC wiring accessory for MicroLogic 5/6



24 V DC power supply connector LV434210

ZSI accessory for NS630b-NW with NSX

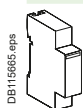

ZSI module LV434212

External power supply module (24 V DC - 1 A), class 4

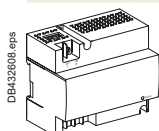

24-30 V DC	LV454440
48-60 V DC	LV454441
100-125 V DC	LV454442
110-130 V AC	LV454443
200-240 V AC	LV454444

Battery module

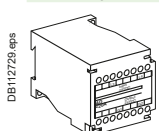

24 V DC battery module 54446



# Installation and connection

## ComPact NSX and ComPact NSX400/630 Vigi add-on

### Fixed/RC device = fixed/FC device + rear connection kit

#### Mixed RC kit

DB111465.eps

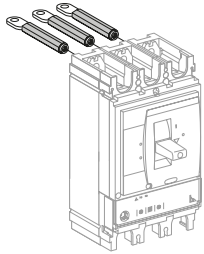

Kit 3P	Short RCs	2 x	<b>LV432475</b>
	Long RCs	1 x	<b>LV432476</b>
Kit 4P	Short RCs	2 x	<b>LV432475</b>
	Long RCs	2 x	<b>LV432476</b>

### Plug-in version = fixed/FC device + plug-in kit

#### Kit for ComPact NSX

DB111467.eps

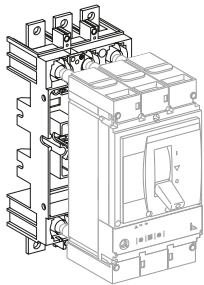

	3P	4P
<b>Plug-in kit</b>	<b>LV432538</b>	<b>LV432539</b>
Comprising:		
Base	= 1 x LV432516	= 1 x LV432517
Power connections	+ 3 x LV432518	+ 4 x LV432518
Short terminal shields	+ 2 x LV432591	+ 2 x LV432592
Safety trip interlock	+ 1 x LV432520	+ 1 x LV432520

#### Kit for ComPact NSX Vigi add-on

DB111469.eps

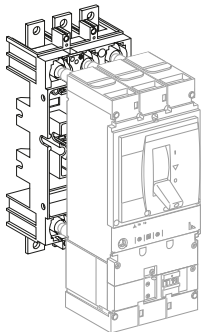

	3P	4P
<b>ComPact NSX Vigi add-on plug-in kit</b>	<b>LV432540</b>	<b>LV432541</b>
Comprising:		
Base	= 1 x LV432516	= 1 x LV432517
Power connections	+ 3 x LV432519	+ 4 x LV432519
Short terminal shields	+ 2 x LV432591	+ 2 x LV432592
Safety trip interlock	+ 1 x LV432520	+ 1 x LV432520

[1] Supplied with 2 or 3 interphase barriers.



# Installation and connection

## ComPact NSX and ComPact NSX400/630 Vigi add-on

Withdrawable version = fixed/FC device + withdrawable kit

### Kit for ComPact NSX

DB111468.eps

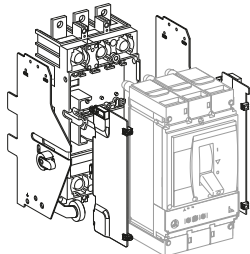

	3P	4P
	<b>Kit for ComPact NSX</b>	<b>Kit for ComPact NSX</b>
	=	=
Plug-in kit:	1 x LV432538	1 x LV432539
	+	+
Chassis side plates for base	1 x LV432532	1 x LV432532
	+	+
Chassis side plates for breaker	1 x LV432533	1 x LV432533

### Kit for ComPact NSX Vigi add-on

DB111714.eps

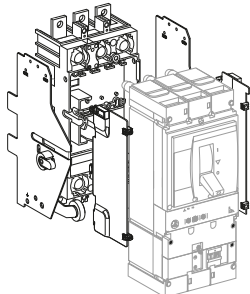





	3P	4P
	<b>Kit for ComPact NSX Vigi add-on</b>	<b>Kit for ComPact NSX Vigi add-on</b>
	=	=
Plug-in kit:	1 x LV432540	1 x LV432541
	+	+
Chassis side plates for base	1 x LV432532	1 x LV432532
	+	+
Chassis side plates for breaker	1 x LV432533	1 x LV432533

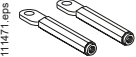
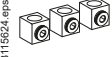
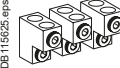

# Accessories and auxiliaries

## ComPact NSX400/630 with/without Vigi add-on

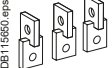
### Connection accessories (Cu or Al)

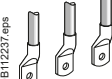
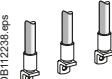
Rear connections				
	2 short			<b>LV432475</b>
	2 long			<b>LV432476</b>
Bare cable connectors <sup>[1]</sup>				
	Aluminium connectors	1 x (35 to 300 mm <sup>2</sup> )	Set of 3	<b>LV432479</b>
			Set of 4	<b>LV432480</b>
	Aluminium connectors for 2 cables	2 x (35 to 240 mm <sup>2</sup> )	Set of 3	<b>LV432481</b>
			Set of 4	<b>LV432482</b>
	6.35 mm voltage tap for aluminium connectors for 1 or 2 cables		Set of 10	<b>LV429348</b>
Terminal extensions <sup>[1]</sup>				
	45° terminal extensions		Set of 3	<b>LV432586</b>
			Set of 4	<b>LV432587</b>
	Edgewise terminal extensions		Set of 3	<b>LV432486</b>
			Set of 4	<b>LV432487</b>
	Right-angle terminal extensions		Set of 3	<b>LV432484</b>
			Set of 4	<b>LV432485</b>
	Spreaders	52.5 mm	3P	<b>LV432490</b>
			4P	<b>LV432491</b>
		70 mm	3P	<b>LV432492</b>
			4P	<b>LV432493</b>
Crimp lugs for copper cable <sup>[1]</sup>				
	For cable 240 mm <sup>2</sup>		Set of 3	<b>LV432500</b>
			Set of 4	<b>LV432501</b>
	For cable 300 mm <sup>2</sup>		Set of 3	<b>LV432502</b>
			Set of 4	<b>LV432503</b>
Crimp lugs for aluminium cable <sup>[1]</sup>				
	For cable 240 mm <sup>2</sup>		Set of 3	<b>LV432504</b>
			Set of 4	<b>LV432505</b>
	For cable 300 mm <sup>2</sup>		Set of 3	<b>LV432506</b>
			Set of 4	<b>LV432507</b>
Supplied with 2 or 3 interphase barriers				

[1] Supplied with 2 or 3 interphase barriers.

# Accessories and auxiliaries

## ComPact NSX400/630 with/without Vigi add-on

### Insulation accessories

<p>DB425487.eps</p>	Short terminal shield, 45 mm (1 piece)	3P	LV432591
		4P	LV432592
<p>DB117163.eps</p> <p>DB117164.eps</p>	Short terminal shield > 500 V (1 piece)	3P	LV433693
		4P	LV433694
<p>DB425468.eps</p>	Long terminal shield, 45 mm (1 piece)	3P	LV432593
		4P	LV432594
<p>DB425469.eps</p>	Long terminal shield for spreaders, 52.5 mm (1 piece) (supplied with insulating plate)	3P	LV432595
		4P	LV432596
<p>DB425470.eps</p>	Interphase barriers	Set of 6	LV432570
<p>DB425471.eps</p>	Connection adapter for plug-in base	3P	LV432584
		4P	LV432585
<p>DB115228.eps</p>	2 insulating screens (70 mm pitch)	3P	LV432578
		4P	LV432579



# Accessories and auxiliaries

## ComPact NSX400/630 with/without Vigi add-on

### Electrical auxiliaries

#### Auxiliary contacts (changeover)

DB11254.eps		OF or SD or SDE or SDV	29450
		OF or SD or SDE or SDV low level	29452

#### SDx output module for MicroLogic electronic trip unit

DB11275.eps		SDx module 24/415 V AC/DC	LV429532
-------------	---	---------------------------	----------

#### SDTAM contactor tripping module (early-break thermal fault signal) for MicroLogic 2.3 M/6.3 E-M

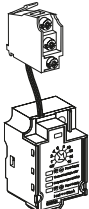
DB11276.eps		SDTAM 24/415 V AC/DC overload fault indication	LV429424
-------------	---	--	----------

#### Voltage releases

	Voltage	MX	MN	
AC	24 V 50/60 Hz	LV429384	LV429404	
	48 V 50/60 Hz	LV429385	LV429405	
	110-130 V 50/60 Hz	LV429386	LV429406	
	220-240 V 50/60 Hz and 208-277 V 60 Hz	LV429387	LV429407	
	380-415 V 50 Hz and 440-480 V 60 Hz	LV429388	LV429408	
	525 V 50 Hz and 600 V 60 Hz	LV429389	LV429409	
DC	12 V	LV429382	LV429402	
	24 V	LV429390	LV429410	
	30 V	LV429391	LV429411	
	48 V	LV429392	LV429412	
	60 V	LV429383	LV429403	
	125 V	LV429393	LV429413	
	250 V	LV429394	LV429414	
	MN 48 V 50/60 Hz with fixed time delay			
	Composed of:	MN 48 V DC	LV429412	
		Delay unit 48 V 50/60 Hz	LV429426	
MN 220-240 V 50/60 Hz with fixed time delay				
Composed of:	MN 250 V DC	LV429414		
	Delay unit 220-240 V 50/60 Hz	LV429427		
MN 48 V DC/AC 50/60 Hz with adjustable time delay				
Composed of:	MN 48 V DC	LV429412		
	Delay unit 48 V DC/AC 50/60 Hz	33680		
MN 110-130 V DC/AC 50/60 Hz with adjustable time delay				
Composed of:	MN 125 V DC	LV429413		
	Delay unit 100-130 V DC/AC 50/60 Hz	33681		
MN 220-250 V DC/AC 50/60 Hz with adjustable time delay				
Composed of:	MN 250 V DC	LV429414		
	Delay unit 200-250 V DC/AC 50-60 Hz	33682		

F

# Accessories and auxiliaries

## ComPact NSX400/630 with/without Vigi add-on

### Motor mechanism

#### Motor mechanism module

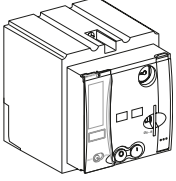
	AC	Voltage	MT400-630
		48-60 V 50/60 Hz	LV432639
		110-130 V 50/60 Hz	LV432640
		220-240 V 50/60 Hz and 208-277 V 60 Hz	LV432641
		380-415 V 50 Hz	LV432642
	DC	440-480 V 60 Hz	LV432647
		24-30 V	LV432643
		48-60 V	LV432644
		110-130 V	LV432645
		250 V	LV432646
Operation counter			LV432648

#### Communicating motor mechanism module

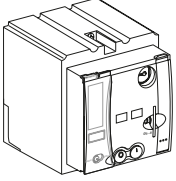
	Motor mechanism module	MTc 400/630	220-240 V 50/60 Hz	LV432652	
	+				
	Breaker status Communication Module	BSCM		LV434205	
	+				
	NSX cord	Wire length L = 0.35 m			LV434200
		Wire length L = 1.3 m			LV434201
		Wire length L = 3 m			LV434202
		U > 480 V AC wire length L = 0.35 m			LV434204

### Indication and measurement modules

#### PowerLogic PowerTag NSX

	Rating (A)	630
	3P	LV434022
	3P+N	LV434023

#### Ammeter module

	Rating (A)	400	630
	3P	LV432655	LV432855
	4P	LV432656	LV432856

#### I max. ammeter module

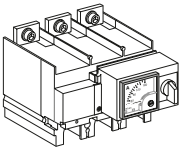
	Rating (A)	400	630
	3P	LV434852	LV434853

#### Current transformer module

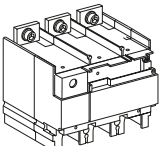
	Rating (A)	400	630
	3P	LV432657	LV432857
	4P	LV432658	LV432858

#### Current transformer module and voltage output

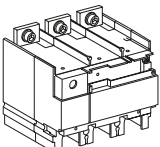
	Rating (A)	400	600
	3P	LV432653	LV432861
	4P	LV432654	LV432862

#### Voltage presence indicator

	3P/4P	LV432566
---	-------	----------

F

# Accessories and auxiliaries

## ComPact NSX400/630 with/without Vigi add-on

### Rotary handles

#### Direct rotary handle

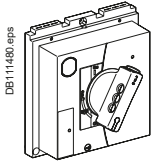

With black handle	LV432597
With red handle on yellow front	LV432599
MCC conversion accessory	LV432606
CNOMO conversion accessory	LV432602

#### Extended rotary handle

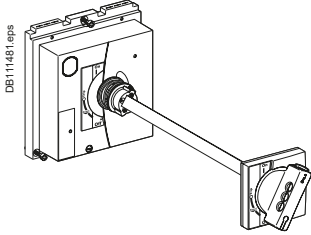

With black handle	LV432598
With red handle on yellow front	LV432600
With telescopic handle for withdrawable device	LV432603

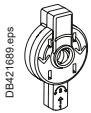

Open door shaft operator	LV426937
--------------------------	----------

#### Accessories for direct or extended rotary handle

Indication auxiliary	1 early-break contact	LV432605
	2 early-make contacts	LV429346

### Locks

#### Toggle locking device for 1 to 3 padlocks

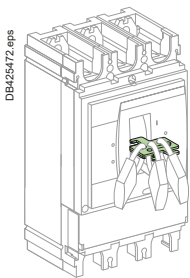

By removable device	29370
---------------------	-------

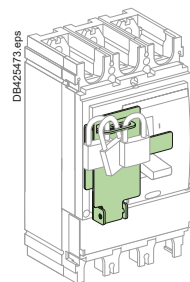

By fixed device for 3P, 4P (open or close position)	LV432631
By fixed device for 3P, 4P (for open position only)	LV432630

#### Locking of rotary handle

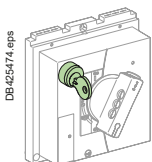

Keylock adapter (keylock not included)	LV432604	
Keylock (keylock adapter not included)	Ronis 1351B.500	41940
	Profalux KS5 B24 D4Z	42888

#### Locking of motor mechanism module

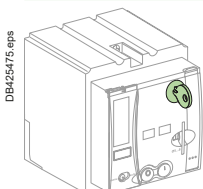

Keylock adapter (keylock not included)	LV432649	
Keylock (keylock adapter not included)	Ronis 1351B.500	41940
	Profalux KS5 B24 D4Z	42888

F

# Accessories and auxiliaries

## ComPact NSX400/630 with/without Vigi add-on

### Interlocking

#### Mechanical interlocking for circuit breakers

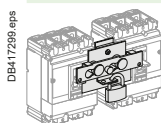
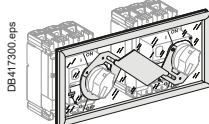
 <p>DB417299 eps</p>	With toggles	LV432614
	With rotary handles	LV432621
 <p>DB417300 eps</p>		

#### Interlocking with key (2 keylocks / 1 key) for rotary handles

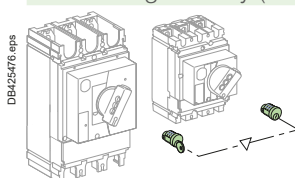
 <p>DB625576 eps</p>	Keylock kit (keylock not included) <sup>[1]</sup>	LV432604	
	1 set of 2 keylocks	Ronis 1351B.500	41950
	(1 key only, keylock kit not included)	Profalux KS5 B24 D4Z	42878

### Installation accessories

#### Front-panel escutcheons

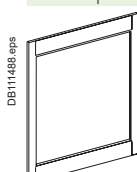
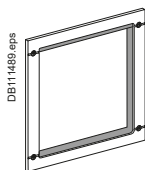
 <p>DB111489 eps</p>	IP30 escutcheon for all control types	LV432557
	IP30 trip unit access escutcheon for toggle	LV432559
	IP30 escutcheon for Vigi add-on	LV429527
IP30		
 <p>DB111488 eps</p>	IP40 escutcheon for all control types	LV432558
	IP40 escutcheon for Vigi add-on	LV429316
	IP40 escutcheon for Vigi add-on or ammeter module	LV429318
IP40		

#### IP43 rubber toggle cover

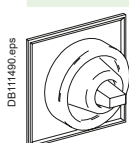
 <p>DB111490 eps</p>	1 toggle cover	LV432560
---	----------------	----------

#### Lead-sealing accessories

 <p>DB1156115 eps</p>	Bag of accessories	LV429375
--	--------------------	----------

#### 60 mm plate

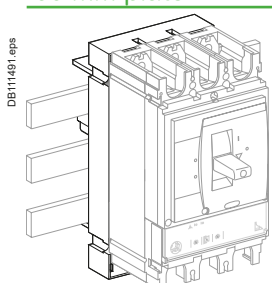
 <p>DB111491 eps</p>	Plate 3P ComPact NSX400/630 IEC	LV432623
	Plate 4P ComPact NSX400/630 IEC	LV432624

[1] For only 1 device.



# Accessories and auxiliaries

## ComPact NSX400/630 with/without Vigi add-on

### Plug-in/withdrawable version accessories

#### Insulation accessories

	Connection adapter for plug-in base	3P	<b>LV432584</b>
		4P	<b>LV432585</b>

#### Auxiliary connections

	1 9-wire fixed connector (for base)		<b>LV429273</b>
---	-------------------------------------	--	-----------------

	1 9-wire moving connector (for circuit breaker)		<b>LV432523</b>
---	---	--	-----------------

	1 support for 3 moving connectors		<b>LV432525</b>
---	-----------------------------------	--	-----------------

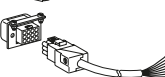
	9-wire manual auxiliary connector (fixed + moving)		<b>LV429272</b>
---	--	--	-----------------

#### Plug-in base accessories

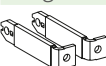
	Long insulated right angle terminal extensions	Set of 2	<b>LV432526</b>
---	--	----------	-----------------

	2 IP40 shutters for base		<b>LV432521</b>
--	--------------------------	--	-----------------

	Base	3P	<b>LV432516</b>
---	------	----	-----------------

	Base	4P	<b>LV432517</b>
---	------	----	-----------------

	Power connections	3/4P	<b>LV432518</b>
---	-------------------	------	-----------------

	Short terminal shields	3P	<b>LV432591</b>
---	------------------------	----	-----------------

	Short terminal shield > 500 V (1 piece)	3P	<b>LV433693</b>
--	---	----	-----------------

	Short terminal shields	4P	<b>LV432592</b>
---	------------------------	----	-----------------

	Short terminal shield > 500 V (1 piece)	4P	<b>LV433694</b>
--	---	----	-----------------

	Safety trip interlock	3/4P	<b>LV432520</b>
---	-----------------------	------	-----------------

#### Chassis accessories

	Escutcheon collar	Toggle	<b>LV432534</b>
---	-------------------	--------	-----------------

	Escutcheon collar	Vigi add-on	<b>LV429285</b>
---	-------------------	-------------	-----------------

	Locking kit (keylock not included)		<b>LV429286</b>
---	------------------------------------	--	-----------------

	Keylock (keylock adapter not included) Ronis 1351B.500		<b>41940</b>
---	--	--	--------------

	Profalux KS5 B24 D4Z		<b>42888</b>
--	----------------------	--	--------------

	2 carriage switches (connected/disconnected position indication)		<b>LV429287</b>
--	--	--	-----------------



F



# Accessories and auxiliaries

## ComPact NSX400/630 with/without Vigi add-on

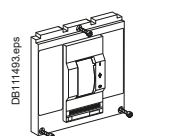
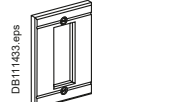
### Spare parts

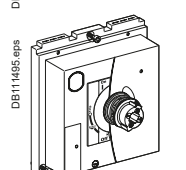
	Additional toggle extension for NSX400/630		<b>32595</b>
	5 spare toggle extensions		<b>LV432553</b>
	Bag of screws		<b>LV432552</b>
	ComPact NS retrofit escutcheon	Small cut-out	<b>LV432571</b>
	IP40 toggle escutcheon	ComPact NS type/small cut-out	<b>32556</b>
	Torque limiting screws (set of 12)	3P/4P ComPact NSX400-630	<b>LV432513</b>
	1 set of 10 identification labels		<b>LV429226</b>
	1 base for extended rotary handle		<b>LV432498</b>
	LCD display for electronic trip unit	MicroLogic 5 MicroLogic 6 MicroLogic E-M	<b>LV429483</b> <b>LV429484</b> <b>LV429486</b>
	5 transparent covers for electronic trip unit	MicroLogic 5/6 MicroLogic 2	<b>LV432459</b> <b>LV432461</b>

### Individual enclosures

#### IP55 steel enclosure

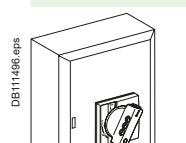
	ComPact NSX400 with black extended rotary handle	<b>LV431219</b>
	ComPact NSX400 with red and yellow extended rotary handle	<b>LV431220</b>
	ComPact NSX630 or ComPact NSX400/630 Vigi add-on with black extended rotary handle	<b>LV431221</b>
	ComPact NSX630 or ComPact NSX400/630 Vigi add-on with red and yellow extended rotary handle	<b>LV431222</b>

#### IP55 insulating enclosure

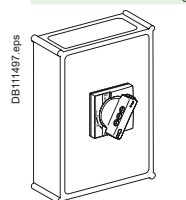
	ComPact NSX400/630 with black extended rotary handle	<b>LV432665</b>
	ComPact NSX400/630 Vigi add-on with black extended rotary handle	<b>LV432666</b>

### Visible break disconnect function

See catalog dealing with "ComPact INV products (visible break)" and the associated accessories.  
The visible break disconnection function is compatible with fixed front-connected/rear-connected ComPact NSX devices.



# Communication, monitoring and control

## ComPact NSX400/630 with/without Vigi add-on

### Communication option

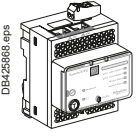
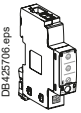
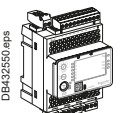
	IFE	Ethernet interface for LV breaker	LV434001
		Ethernet interface for LV breakers and gateway	LV434002
	IFM Modbus-SL interface module		LV434000
	I/O application module		LV434063
	User guide IFE		DOCA0084EN
	User guide I/O application module		DOCA0055EN

### Monitoring and control (remote operation)

#### Circuit breaker accessories

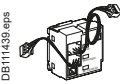
	Breaker Status Control Module	BSCM <sup>[1]</sup>	LV434205
--	-------------------------------	---------------------	----------

#### ULP display module<sup>[2]</sup>

	Switchboard front display module FDM121		TRV00121
	FDM mounting accessory (diameter 22 mm)		TRV00128

#### Ethernet display module

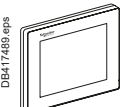
	Switchboard front display module FDM128		LV434128
--	---	--	----------

#### ULP wiring accessories

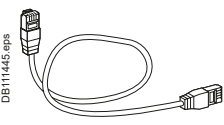
	NSX cord L = 0.35 m		LV434200
	NSX cord L = 1.3 m		LV434201
	NSX cord L = 3 m		LV434202
	NSX cord for U > 480 V AC L = 1.3 m		LV434204
	10 stacking connectors for communication interface modules		TRV00217
	2 Modbus line terminators		VW3A8306DRC <sup>[3]</sup>
	Connector Modbus adaptor		LV434211
	RS 485 roll cable (4 wires, length 60 m)		50965
	5 RJ45 connectors female/female		TRV00870
	10 ULP line terminators		TRV00880
	10 RJ45/RJ45 male cord L = 0.3 m		TRV00803
	10 RJ45/RJ45 male cord L = 0.6 m		TRV00806
	5 RJ45/RJ45 male cord L = 1 m		TRV00810
	5 RJ45/RJ45 male cord L = 2 m		TRV00820
	5 RJ45/RJ45 male cord L = 3 m		TRV00830
	1 RJ45/RJ45 male cord L = 5 m		TRV00850

[1] SDE adapter mandatory for trip unit TM, MA or MicroLogic 2 (LV429451).

[2] For measurement display with MicroLogic A and E or status display with BSCM.

[3] www.schneider-electric.com.

# Monitoring and control, accessories

## ComPact NSX400/630 with/without Vigi add-on

### Accessories

#### Power supply modules

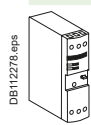
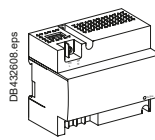

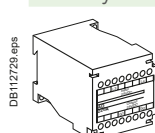

	External power supply module 100-240 V AC 110-230 V DC / 24 V DC-3 A class 2	<b>ABL8RPS24030</b> <sup>[1]</sup>
	External power supply module 24 V DC-1 A OVC IV 24-30 V DC 48-60 V DC 100-125 V DC 110-130 V AC 200-240 V AC	<b>LV454440</b>   <b>LV454441</b>   <b>LV454442</b>   <b>LV454443</b>   <b>LV454444</b>

#### Battery module

	24 V DC battery module	<b>54446</b>
---	------------------------	--------------

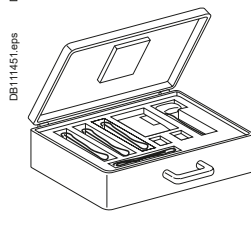
### Test tool, software, demo

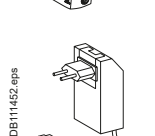
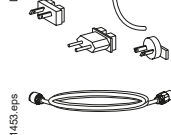
#### Test tool

	Pocket battery for MicroLogic NSX100-630	<b>LV434206</b>
	Maintenance case Comprising: - USB maintenance interface - Power supply - MicroLogic cord - USB cord - RJ45/RJ45 male cord	<b>TRV00910</b>
	Spare USB maintenance interface	<b>TRV00911</b>
	Spare power supply 110-240 V AC	<b>TRV00915</b>
	Spare MicroLogic cord for USB maintenance interface	<b>TRV00917</b>
	Bluetooth/Modbus option for USB maintenance interface	<b>VW3A8114</b> <sup>[1]</sup>

#### Software

	Configuration and setting EcoStruxure Power Commission software	<b>LV4ST100</b> <sup>[2]</sup>
	Test software LTU	<b>LV4ST121</b> <sup>[2]</sup>
	Monitoring EcoStruxure Power Commission software	<b>LV4SM100</b> <sup>[2]</sup>

#### Demo tool

	Demo case for ComPact NSX	<b>LV434207</b>
--	---------------------------	-----------------

[1] See Telemecanique catalog.

[2] Downloadable from <http://schneider-electric.com>.

F

# Source-changeover systems for 2 devices

## ComPact NSX100 to NSX630

### Manual source-changeover

#### Mechanical interlocking

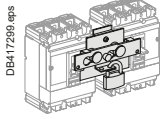

For toggle controlled circuit breakers	NSX100...250	<b>LV429354</b>
	NSX400...630	<b>LV432614</b>

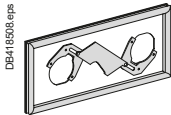

For rotary handled circuit breakers	NSX100...250	<b>LV429369</b>
	NSX400...630	<b>LV432621</b>

#### Interlocking on base plate

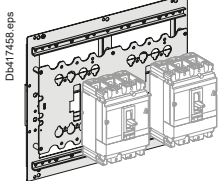

For 2 devices side by side	<b>29349</b>
	<b>32609</b>

#### Keylock interlocking

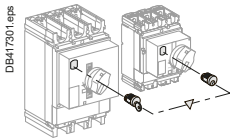

For rotary handled or remote controlled circuit breakers 2 locks, 1 key	Ronis 1351B.500	<b>41950</b>
	Profalux KS5 B24 D4Z	<b>42878</b>

### Connection accessories

#### Downstream coupling accessories

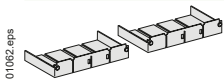

+

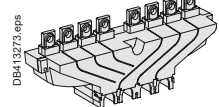

Short terminal shields (1 pair) + "S1" source/"S2" source	3P	4P
NSX100...250/NSX100...250/ 250 A	<b>LV429358</b>	<b>LV429359</b>
NSX400...630/NSX400...630/ 630 A	<b>LV432619</b>	<b>LV432620</b>

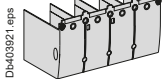

Long terminal shields (1 pair)		
NSX100...250/NSX100...250		<b>LV429518</b>
NSX400...630/NSX400...630		<b>LV432594</b>
Long terminal shield for spreaders, 52.5 mm (1 piece)	<b>LV432596</b>	<b>LV432596</b>

#### Terminal extensions

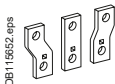

Spreaders	52.5 mm	4P	<b>LV432491</b>
-----------	---------	----	-----------------

# Source-changeover systems for 2 devices

## ComPact NSX100 to NSX630

### Typical composition of source-changeover system

#### Remote source-changeover

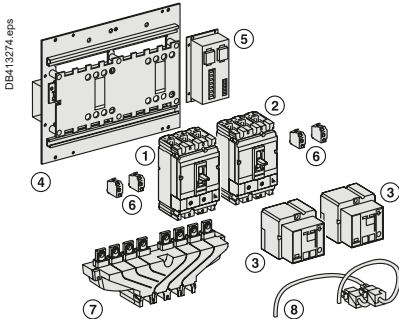

- 1 normal device N (1)
- + 1 replacement device R (2)
- + 2 remote controls (3)
- + 1 plate with interlocking (4) with IVE (5) and its wiring (8)
- + 2 plug-in kits (if plug-in version)
- + 1 adaptor kit for NSX100...250 plug-in (if NSX400...630 with NSX100...250)
- + auxiliary switches (6)
- 2 x (1 OF + 1 SDE) for ComPact NSX100...630
- + 1 downstream coupling accessory (7) for ComPact NSX100...630 (option)
- + long RC (if back connection)

IVE and remote controls must have the same voltage.

#### Associated controller

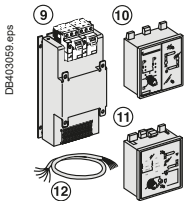

- 1 source changeover without associated controller
- + 1 ACP (9) with BA controller (10)
- Or + 1 ACP (9) with UA controller (11)
- Or + 1 ACP (9) with UA150 controller (11)
- + extension (12) for remote UA/BA connection on front of switchboard

IVE + remote control + ACP + BA or UA must have the same voltage.

### Automatic source-changeover

#### Mechanical and electrical interlocking

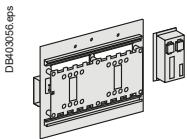

Source "normal"/source "replacement" (identical voltages)	24 to 250 V DC	48 to 415 V AC 50/60 Hz 440 V 60 Hz
<b>NSX100...250/NSX100...250</b>		
Plate + IVE	<b>29351</b>	<b>29350</b>
Plate	<b>29349</b>	<b>29349</b>
IVE	<b>29356</b>	<b>29352</b>
Auxiliary switches 2 OF + 2 SDE	4 x <b>29450</b>	4 x <b>29450</b>
Spare wiring system (device/IVE)	<b>29365</b>	<b>29365</b>
Back sockets option add: Only long RC	[2]	[2]
Plug in base option add: Plug in kit	[2]	[2]
<b>NSX400...630/NSX100...630</b>		
Plate + IVE	<b>32611</b>	<b>32610</b>
Plate	<b>32609</b>	<b>32609</b>
IVE	<b>29356</b>	<b>29352</b>
Auxiliary switches 2 OF + 2 SDE	4 x <b>29450</b>	4 x <b>29450</b>
Spare wiring system (device/IVE)	<b>29365</b>	<b>29365</b>
Back sockets option add: Only long RC	[2]	[2]
Plug in base option add: Plug in kit	[2]	[2]
Adaptator kit for NSX100...250	1 x <b>32618</b>	1 x <b>32618</b>

#### Controller

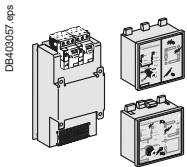

	110/127 V AC 50/60 Hz	220/240 V AC 50/60 Hz	380/415 V AC 50/60 Hz 440 V 60 Hz
ACP + controller BA [1]		<b>29470</b>	<b>29471</b>
Plate ACP		<b>29363</b>	<b>29364</b>
Controller BA		<b>29376</b>	<b>29377</b>
ACP + controller UA [1]	<b>29448</b>	<b>29472</b>	<b>29473</b>
Plate ACP	<b>29447</b>	<b>29363</b>	<b>29364</b>
Controller UA	<b>29446</b>	<b>29378</b>	<b>29380</b>

#### Wiring cable between BA/UA and ACP/IVE

Wiring cable (1.5 meter)	<b>29368</b>	<b>29368</b>
--------------------------	--------------	--------------

[1] The supply voltages BA/UA controller, ACP plate, IVE and the remote control must be identical whatever the source-changeover type.  
 [2] See products pages.

# NSX100/400 for utilities, "tarif jaune" public distribution

## Complete fixed/FC device without accessories

### ComPact NSX with MicroLogic AB

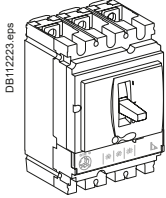

#### ComPact NSX

	Rating	4P
NSX100F MicroLogic AB	100	LV434562
NSX160F MicroLogic AB	160	LV434563
NSX250F MicroLogic AB	240	LV434564
NSX400F MicroLogic AB	400	LV434565

Comprising:	Basic frame	MicroLogic AB
NSX100F + MicroLogic AB 100	LV429008	LV434550
NSX160F + MicroLogic AB 160	LV430408	LV434551
NSX250F + MicroLogic AB 240	LV431408	LV434554
NSX400F + MicroLogic AB 400	LV432415	LV434557

### ComPact NSX Vigi add-on with MicroLogic AB

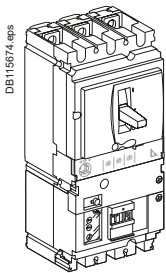

#### ComPact NSX Vigi add-on

	Rating	4P
NSX100F MicroLogic AB	100	LV434572
NSX160F MicroLogic AB	160	LV434573
NSX250F MicroLogic AB	240	LV434574
NSX400F MicroLogic AB	400	LV434575

Comprising:	Basic frame	MicroLogic AB	Vigi add-on MH/MB
NSX100F + MicroLogic AB 100 + MH	LV429008	LV434550	LV429211
NSX160F + MicroLogic AB 160 + MH	LV430408	LV434551	LV429211
NSX250F + MicroLogic AB 240 + MH	LV431408	LV434554	LV431536
NSX400F + MicroLogic AB 400 + MB	LV432415	LV434557	LV432456

# NSX100/400 for utilities, "tarif jaune" public distribution

## Complet fixed/FC device without accessories

### ComPact NSX with normal trip unit

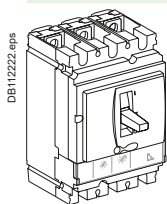

#### ComPact NSX100F

Rating	4P 3d	4P 4d
TM40D	LV429644	LV429654
TM63D	LV429642	LV429652
TM80D	LV429641	LV429651
TM100D	LV429640	LV429650

#### ComPact NSX160F

Rating	4P 3d	4P 4d
TM80D	LV430643	LV430653
TM100D	LV430642	LV430652
TM125D	LV430641	LV430651
TM160D	LV430640	LV430650

#### ComPact NSX250F

Rating	4P 3d	4P 4d
TM125D	LV431643	LV431653
TM160D	LV431642	LV431652
TM200D	LV431641	LV431651
TM250D	LV431640	LV431650

#### ComPact NSX400F

	4P 3d	4P 4d
MicroLogic 2.3	LV432677	LV432677

### ComPact NSX with normal trip unit

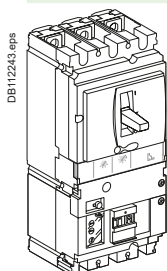

#### ComPact NSX100F Vigi add-on

Rating	4P 3d	4P 4d
TM40D	LV429944	LV429954
TM63D	LV429942	LV429952
TM80D	LV429941	LV429951
TM100D	LV429940	LV429950

#### ComPact NSX160F Vigi add-on

Rating	4P 3d	4P 4d
TM80D	LV430943	LV430953
TM100D	LV430942	LV430952
TM125D	LV430941	LV430951
TM160D	LV430940	LV430950

#### ComPact NSX250F Vigi add-on

Rating	4P 3d	4P 4d
TM125D	LV431943	LV431953
TM160D	LV431942	LV431952
TM200D	LV431941	LV431951
TM250D	LV431940	LV431950

#### ComPact NSX400F Vigi add-on

	4P 3d	4P 4d
MicroLogic 2.3	LV432732	LV432732



## Catalog numbers

# NSX100/400 for utilities, "tarif jaune" public distribution

## Visible break

## ComPact INV100 to INV630 standard version

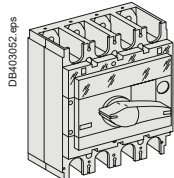
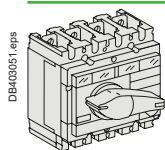

ComPact INV100	For ComPact NSX100	<b>4P</b>
ComPact INV160	For ComPact NSX160	<b>31161</b>
ComPact INV200	For ComPact NSX250	<b>31165</b>
ComPact INV250	For ComPact NSX250	<b>31163</b>
		<b>31167</b>
		<b>4P</b>
ComPact INV320	For ComPact NSX400	<b>31169</b>
ComPact INV400	For ComPact NSX400	<b>31171</b>

## Spare viewport

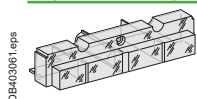

For INV100 to 250	<b>31089</b>
For INV320/400	<b>31090</b>

## Combination with ComPact NSX devices

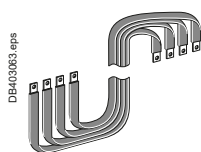
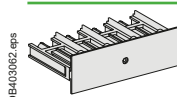

INV100 to 250 - NSX250 combination assembly	<b>31066</b>
INV320/400 - NSX250 combination assembly	<b>31067</b>
Front alignment base for INV320/400 - NSX250 combination assembly	<b>31064</b>
INV320/400 - NSX400 combination assembly	<b>31068</b>
Flexible connection assembly for vertical INV100 to 250 with NSX horizontal N <sup>[1]</sup>	<b>04443</b>
Flexible connection assembly for vertical INV100 to 250 with NSX horizontal V <sup>[1]</sup>	<b>04444</b>
Flexible connection assembly for vertical INV320 to 630 with NSX horizontal N <sup>[1]</sup>	<b>04445</b>
Flexible connection assembly for vertical INV320 to 630 with NSX horizontal V <sup>[1]</sup>	<b>04446</b>
Flexible connection assembly for vertical INV100 to 250 with vertical NSX250 beside	<b>31071</b>
Flexible connection assembly for vertical INV320 to 630 with vertical NSX400/630 beside	<b>31072</b>
Flexible connection assembly for vertical INV320 to 630 with vertical NSX250 beside	<b>31093</b>

[1] Product sold by MGA and valid for new Prisma only.



# NSX100/400 for utilities, "tarif jaune" public distribution

## Installation and connection with or without the visible break function

### Conventional installation

#### Combination assembly

#### Upstream and downstream connection

INV100 to 250 - NSX100/160/250	4 snap-on bare cable connectors for cables:	1.5 to 95 mm <sup>2</sup> ; ≤ 160 A	2x	LV429243
		10 to 185 mm <sup>2</sup> ; ≤ 250 A	2x	LV429260
	10 clips for bare cable connector		1x	LV429241
	4 right-angle terminal extensions		2x	LV429262
	2 long terminal shields		1x	LV429518
INV320/400 - NSX100/160/250	4 bare cable connectors:	For 1 cable, 35 mm <sup>2</sup> to 300 mm <sup>2</sup>	1x	LV432480
		For 2 cables, 35 mm <sup>2</sup> to 240 mm <sup>2</sup>	1x	LV432482
	4 right-angle terminal extensions		1x	LV432485
	1 long terminal shield		1x	LV432594
	4 snap-on bare cable connectors for cables:	1.5 to 95 mm <sup>2</sup> ; ≤ 160 A	1x	LV429243
		10 to 185 mm <sup>2</sup> ; ≤ 250 A	1x	LV429260
	10 clips for bare cable connector		1x	LV429241
	4 right-angle terminal extensions		1x	LV429262
	1 long terminal shield		1x	LV429518
	INV320/400 - NSX400	4 bare cable connectors:	For 1 cable, 35 mm <sup>2</sup> to 300 mm <sup>2</sup>	2x
For 2 cables, 35 mm <sup>2</sup> to 240 mm <sup>2</sup>			2x	LV432482
4 right-angle terminal extensions			2x	LV432485
1 long terminal shield			1x	LV432594

### Installation in cabinet or enclosure

#### Combination assembly (mounting in duct)

#### Flexible connection assembly (mounting in cubicle)

#### Upstream and downstream connection

INV100 to 250 - NSX100/160/250	4 snap-on bare cable connectors for cables:	1.5 to 95 mm <sup>2</sup> ; ≤ 160 A	2x	LV429243	
		10 to 185 mm <sup>2</sup> ; ≤ 250 A	2x	LV429260	
	1 short terminal shield		1x	LV429516	
INV320/400 - NSX100/160/250	4 bare cable connectors:	For 1 cable, 35 mm <sup>2</sup> to 300 mm <sup>2</sup>	1x	LV432480	
		For 2 cables, 35 mm <sup>2</sup> to 240 mm <sup>2</sup>	1x	LV432482	
	1 short terminal shield		1x	LV432592	
	4 snap-on bare cable connectors for cables:	1.5 to 95 mm <sup>2</sup> ; ≤ 160 A	1x	LV429243	
		10 to 185 mm <sup>2</sup> ; ≤ 250 A	1x	LV429260	
INV320/400 - NSX400	4 bare cable connectors:	For 1 cable, 35 mm <sup>2</sup> to 300 mm <sup>2</sup>	2x	LV432480	
		For 2 cables, 35 mm <sup>2</sup> to 240 mm <sup>2</sup>	2x	LV432482	
	1 short terminal shield		1x	LV429516	
	1 short terminal shield		1x	LV432592	

# ComPact NSX100 to NSX630 order form

Name of customer: .....  
 Address for delivery: .....  
 Requested delivery date: .....  
 Customer order no.: .....

To indicate your choices, check the applicable square boxes   
 or note the quantity

and enter the appropriate information in the rectangles

### Circuit breaker or switch-disconnector

ComPact type  **NSX100/160/250 - 160A not available with R, HB1 or HB2**  
**NSX400/630**

Rating **A**

Circuit breaker **B, F, N, H, S, L, R, HB1, HB2**

Switch-disconnector **NA**

Number of poles **1, 2, 3 or 4**

Number of poles protected **2d, 3d or 4d**

Fixed device  Front connections

Plug-in/withdr.  Plug-in  Withdrawable

Earth-leakage protection **ME, MH, MB (not available with R, HB1 or HB2)**

Vigi add-on Voltage < 550 V  V   
 4P option on 3P NSX

### Trip unit

**Thermal-mag.**  **TMD** rating (16 ... 250 A) (40 ... 250 A) with R, HB1 and (63...250 A) with HB2  
 **TMG** rating (16 ... 250 A) - not available with R, HB1 or HB2  
 **MA** rating (2.5 ... 220 A) (12.5 ... 220 A) with R, HB1 and HB2

**Electronic**  **MicroLogic 2.2**  **MicroLogic 2.3**  
 \* Not available with R, HB1 or HB2  **MicroLogic 2.2 G\***  **MicroLogic 2.3 AB\***  
 **MicroLogic 2.2 AB\***  **MicroLogic Vigi 4.3**  
 **MicroLogic Vigi 4.2**  **MicroLogic Vigi 4.3 AL**  
 **MicroLogic Vigi 4.2 AL**  **MicroLogic Vigi 4.3 AB**  
 **MicroLogic Vigi 4.2 AB**  **MicroLogic 5.3 A\***  
 **MicroLogic 5.2 A\***  **MicroLogic 5.3 E**  
 **MicroLogic 5.2 E**  **MicroLogic 5.3 A-Z\***  
 **MicroLogic 5.2 A-Z\***  **MicroLogic 6.3 A\***  
 **MicroLogic 6.2 A\***  **MicroLogic 6.3 E**  
 **MicroLogic 6.2 E**  **MicroLogic Vigi 7.3 E**  
 **MicroLogic Vigi 7.2 E**  **MicroLogic Vigi 7.3 E AL**  
 **MicroLogic Vigi 7.2 AL**  **MicroLogic 1.3 M**  
 **MicroLogic 2.2 M**  **MicroLogic 2.3 M**  
 **MicroLogic 6.2 E-M**  **MicroLogic 6.3 E-M**  
 **SDTAM Module**

External neutral CT

24 V DC power supply connector

ZSI connector accessory for plug-in and withdrawable

ZSI wiring accessory for NS630b / MTZ

External power supply module 24 V DC

24-30 V DC  48-60 V DC   
 100-125 V AC  110-130 V AC   
 200-240 V AC

Battery module

**Connection**

Rear-connection kit Short  Long

NSX100/250 connectors

Snap-on 1.5<sup>□</sup> to 95<sup>□</sup> (< 160 A)  
 Snap-on 25<sup>□</sup> to 95<sup>□</sup> (< 250 A)  
 Snap-on 120<sup>□</sup> to 185<sup>□</sup> (< 250 A)  
 Distribution 6 x 1.5<sup>□</sup> to 35<sup>□</sup>  
 Aluminium 1 cable 25 to 95  
 Aluminium 1 cable 120 to 185  
 Aluminium 1 cable 120 to 250  
 Aluminium 2 cables 50<sup>□</sup> to 120<sup>□</sup>

NSX400/630 connectors

1 cable 35<sup>□</sup> to 300<sup>□</sup>  
 2 cables 35<sup>□</sup> to 240<sup>□</sup>

Right-angle terminal extensions

Straight extensions  NSX100/250

Edgewise extensions 45° terminal extension  Double-L terminal extensions

Spreader  NSX100/250 (one piece)  (45 mm)  
 NSX400/630 (52.5 mm)  (70 mm)

Cu cable lugs  NSX100/250 120<sup>□</sup>  150<sup>□</sup>  185<sup>□</sup>  
 NSX400/630 240<sup>□</sup>  300<sup>□</sup>

Al cable lugs  NSX100/250 150<sup>□</sup>  185<sup>□</sup>  
 NSX400/630 240<sup>□</sup>  300<sup>□</sup>

Voltage measurement input for connector For lugs NSX100/250 ≤ 185<sup>□</sup>  
 For lugs NSX400/630

Terminal shields  NSX100/250 Short  Long   
 NSX400/630 Short  Long   
 Short ≥ 500 V  Long for 52.5 mm spreaders

Interphase barriers  Set of 6

2 insulating screens:  NSX100/250  
 NSX400/630 70 pitch

### Test tool

Pocket battery for MicroLogic  Power supply 110-240 V AC

Maintenance case  Spare MicroLogic cord

USB maintenance interface

### Indication and measurement

PowerLogic PowerTag NSX  3P  4P

Ammeter module standard  3P  4P   
 I max  3P

Current-transformer module  3P  4P

Current-transformer module + TCU  3P  4P

Insulation-monitoring module - not available with HB1 or HB2  3P  4P

Voltage-presence indicator - not available with HB1 or HB2

Auxiliary contact OF, SD, SDE or SDV Standard  Low level

SDE adapter (TM, MA or MicroLogic 2 trip units)

SDX module

### Remote operation

Electrical operation Motor mechanism AC  DC  V

Voltage releases Instantaneous MX AC  DC  V   
 MN AC  DC  V   
 Fixed time delay MN AC  DC  V   
 Adjust. time delay MN AC  DC  V

### Rotary handles

Direct  Black  Red and yellow front   
 MCC conversion access.  CNOMO conversion access.   
 Black  Red and yellow front

Extended  Telescopic handle for withdrawable device   
 Open door shaft operator

Indication auxiliary  1 early-break switch  2 early-make switches

### Locking

Toggle (1 to 3 padlocks) Removable  Fixed

Rotary handle  Keylock adapter (keylock not included)  Profalux KS5 B24 D4Z  
 Keylocks Ronis 1351B.500

Motor mechanism  Keylock adapter + keylock Ronis (special)  NSX100/250  
 Keylock adapter (keylock not included)  NSX400/630  
 Keylocks Ronis 1351B.500  Profalux KS5 B24 D4Z

### Interlocking

Mechanical  Toggle operated  Rotary Handle

By key (2 keylocks, 1 key)  Locking kit without locks

For rotary handle  Keylocks Ronis 1351B.500  Profalux KS5 B24 D4Z

### Installation accessories

IP30 escutcheon for all types (toggle/rotary handle/motor mechanism)

IP30 escutcheon (with access to toggle + trip unit)

IP30 escutcheon for Vigi add-on

IP40 escutcheon for all types (toggle/rotary handle/motor mechanism)

IP40 escutcheon for Vigi add-on

IP40 escutcheon for Vigi add-on or ammeter module

Toggle cover

Sealing accessories

DIN rail adapter  NSX100/250

3P 60 mm busbar adapter

### Plug-in / withdrawable configuration accessories

Auxiliary connections  1 automatic connector fixed part with 9 wires (for base)   
 1 automatic connector moving part with 9 wires (for circuit breaker)   
 1 support for 3 automatic connector moving parts  1 support for 2 automatic connector   
 9-wire manual auxiliary connector (fixed + moving)

Plug-in base accessories  Long insulated terminals  Set of 2   
 2 IP4 shutters for base

Chassis accessories  Escutcheon collar  Toggle  Vigi   
 Locking kit (keylock not included)   
 2 carriage switches (conn./disconnected position indication)

Parts or plug-in  Plug-in base FC/RC 2P  3P  4P

Withdrawable kits  Set of two power connections  Standard  Vigi   
 Safety trip for advanced opening   
 For 3P/4P chassis  Moving part  Fixed part

Adapter for plug-in base (for terminal shield or interphase barriers)

### Communication

NSX Cord L = 0.35 m  NSX Cord L = 1.3 m   
 NSX Cord U > 480 V AC L = 0.35 m  NSX Cord L = 3 m

BSCM

Communicating motor mechanism 220-240 V

Switchboard front display module FDM121

FDM mounting accessory

Ethernet Interface + Gateway

Ethernet Interface

Modbus interface

I/O Application Module  Qty 1   
 Qty 2

Stacking accessory

ULP line termination

RJ45 connectors female/female  Wire length RJ45 L = 0.3 m  Wire length RJ45 L = 0.6 m   
 Wire length RJ45 L = 1 m  Wire length RJ45 L = 2 m   
 Wire length RJ45 L = 3 m  Wire length RJ45 L = 5 m

# Glossary

Accessories.....	G-2
Circuit-breaker characteristics (IEC 60947-2).....	G-2
Communication.....	G-4
Components.....	G-6
Controls.....	G-6
Selectivity / Cascading.....	G-6
Environment.....	G-7
Harmonics.....	G-8
Measurements.....	G-9
Protection.....	G-10
Relays and auxiliary contacts.....	G-10
Switchgear.....	G-11
Three-phase asynchronous motors and their protection.....	G-11
Trip units.....	G-12



<b>Other chapters</b>	
Select your circuit breakers and switch-disconnectors.....	A-1
Select your protection.....	B-1
Customize your circuit breaker with accessories.....	C-1
Smart Panel integration.....	D-1
Switchboard integration.....	E-1
Catalog numbers.....	F-1
Additional characteristics.....	H-1

# Glossary

For each major section (Accessories, Switchgear, etc.) and for each item (Adapter for plug-in base, Connection terminal, etc.), this glossary provides:

- the page number in the concerned catalog
- the reference standard
- the standardised IEC symbol
- the definition.

Text in quotation marks is drawn from the standards.

## Accessories .....

<b>Adapter for plug-in base</b>	The adapter is a plastic component that can be installed upstream and/or downstream of the plug-in base and enables use of all the connection accessories of the fixed device.
<b>Bare-cable connector</b>	Conducting part of the circuit breaker intended for connection to power circuits. On ComPact NSX, it is an aluminium part that screws to the connection terminals of the circuit breaker. There are one or more holes (single or multiple cable connector) for the ends of bare cables.
<b>Connection terminals</b>	Flat copper surface, linked to the conducting parts of the circuit breaker and to which power connections are made using bars, connectors or lugs.
<b>One-piece spreader</b>	The spreader is a plastic component with copper connectors that can be installed upstream and/or downstream of a ComPact NSX100 to 250 circuit breaker with a pole pitch of 35 mm. It increases the pitch of the circuit-breaker terminals to the 45 mm pitch of a NSX400/630 device to facilitate connection of large cables.
<b>Spreaders</b>	Set of three (3P device) or four (4P) flat, conducting parts made of aluminium. They are screwed to the circuit-breaker terminals to increase the pitch between poles.

## Circuit-breaker characteristics (IEC 60947-2) .....

<b>Breaking capacity</b>	Value of prospective current that a switching device is capable of breaking at a stated voltage under prescribed conditions of use and behaviour. Reference is generally made to the ultimate breaking capacity (Icu) and the service breaking capacity (Ics).
<b>Degree of protection (IP) IEC 60529</b>	<p>Defines device protection against the penetration of solid objects and liquids, using two digits specified in standard IEC 60259. Each digit corresponds to a level of protection, where 0 indicates no protection.</p> <ul style="list-style-type: none"> <li>■ First digit (0 to 6): protection against penetration of solid foreign objects. 1 corresponds to protection against objects with a diameter &gt; 50 mm, 6 corresponds to total protection against dust.</li> <li>■ Second digit (0 to 8): protection against penetration of liquids (water). 1 corresponds to protection against falling drops of water (condensation), 8 corresponds to continuous immersion.</li> </ul> <p>The enclosure of ComPact NSX circuit breakers provides a minimum of IP40 (protection against objects &gt; 1 mm) and can reach IP56 (protection against dust and powerful water jets) depending on the installation conditions.</p>
<b>Degree of protection against external mechanical impacts (IK)</b>	<p>Defines the aptitude of an object to resist mechanical impacts on all sides, indicated by a number from 0 to 10 (standard IEC 62262). Each number corresponds to the impact energy (in Joules) that the object can handle according to a standardised procedure.</p> <p>0 corresponds to no protection, 1 to an impact energy of 0.14 Joules, 10 to an impact energy of 20 Joules. ComPact NSX provide IK07 (2 Joules) and can provide IK08 (5 Joules) depending on the installation conditions.</p>
<b>Durability</b>	The term "durability" is used in the standards instead of "endurance" to express the expectancy of the number of operating cycles which can be performed by the equipment before repair or replacement of parts. The term "endurance" is used for specifically defined operational performance.
<b>Electrical durability IEC 60947-1</b>	With respect to its resistance to electrical wear, equipment is characterised by the number of on-load operating cycles, corresponding to the service conditions given in the relevant product standard, which can be made without re replacement.



<b>Frame size</b>	<p>"A term designating a group of circuit breakers, the external physical dimensions of which are common to a range of current ratings. Frame size is expressed in amperes corresponding to the highest current rating of the group. Within a frame size, the width may vary according to the number of poles. This definition does not imply dimensional standardization."</p> <p>ComPact NSX has two frame sizes covering 100 to 250 A and 400 to 630 A.</p>
<b>Insulation class</b>	<p>Defines the type of device insulation in terms of earthing and the corresponding safety for user, in one of three classes.</p> <ul style="list-style-type: none"> <li>■ Class I. The device is earthed. Any electrical faults, internal or external, or caused by the load, are cleared via the earthing circuit, thus ensuring user safety.</li> <li>■ Class II. The device is not connected to a protective conductor. User safety is ensured by reinforced insulation around the live parts (an insulating case and no contact with live parts, i.e. plastic buttons, molded connections, etc.) or double insulation.</li> <li>■ Class III. The device may be connected only to SELV (safety extra-low voltage) circuits. The ComPact NSX are class II devices (front) and may be installed through the door in class II switchboards (standards IEC 61140 and IEC 60664-1), without reducing insulation, even with a rotary handle or motor mechanism module.</li> </ul>
<b>Making capacity</b>	Value of prospective making current that a switching device is capable of making at a stated voltage under prescribed conditions of use and behaviour. Reference is generally made to the short-circuit making capacity I <sub>cm</sub> .
<b>Maximum break time</b>	Maximum time after which breaking is effective, i.e. the contacts separated and the current completely interrupted.
<b>Mechanical durability</b>	With respect to its resistance to mechanical wear, equipment is characterised by the number of no-load operating cycles which can be effected before it becomes necessary to service or replace any mechanical parts.
<b>Non-tripping time</b>	This is the minimum time during which the protective device does not operate in spite of pick-up overrun, if the duration of the overrun does not exceed the corresponding voluntary time delay.
<b>Pollution degree of environment conditions</b> IEC 60947-1 IEC 60664-1	<p>"Conventional number based on the amount of conductive or hygroscopic dust, ionized gas or salt and on the relative humidity and its frequency of occurrence, resulting in hygroscopic absorption or condensation of moisture leading to reduction in dielectric strength and/or surface resistivity". Standard IEC 60947-1 distinguishes four pollution degrees.</p> <ul style="list-style-type: none"> <li>■ Degree 1. No pollution or only dry, non-conductive pollution occurs.</li> <li>■ Degree 2. Normally, only non-conductive pollution occurs. Occasionally, however, a temporary conductivity caused by condensation may be expected.</li> <li>■ Degree 3. Conductive pollution occurs, or dry, non-conductive pollution occurs which becomes conductive due to condensation.</li> <li>■ Degree 4. The pollution generates persistent conductivity caused, for instance, by conductive dust or by rain or snow. ComPact NSX meets degree 3, which corresponds to industrial applications.</li> </ul>
<b>Prospective short-circuit current</b>	Current that would flow through the poles if they remained fully closed during the short-circuit.
<b>Rated current (I<sub>n</sub>)</b>	This is the current that the device can carry continuously with the contacts closed and without abnormal temperature rise.
<b>Rated impulse withstand voltage (U<sub>imp</sub>)</b>	"The peak value of an impulse voltage of prescribed form and polarity which the equipment is capable of withstanding without failure under specified conditions of test and to which the values of the clearances are referred. The rated impulse withstand voltage of an equipment shall be equal to or higher than the values stated for the transient overvoltages occurring in the circuit in which the equipment is fitted".
<b>Rated insulation voltage (U<sub>i</sub>)</b>	"The rated insulation voltage of an equipment is the value of voltage to which dielectric tests and creepage distances are referred. In no case shall the maximum value of the rated operational voltage exceed that of the rated insulation voltage".
<b>Rated operational current (I<sub>e</sub>)</b>	"A rated operational current of an equipment is stated by the manufacturer and takes into account the rated operational voltage, the rated frequency, the rated duty, the utilization category and the type of protective enclosure, if appropriate".
<b>Rated operational voltage (U<sub>e</sub>)</b>	<p>"A value of voltage which, combined with a rated operational current, determines the application of the equipment and to which the relevant tests and the utilisation categories are referred. For multipole equipment, it is generally stated as the voltage between phases".</p> <p>This is the maximum continuous voltage at which the equipment may be used.</p>

# Glossary

<b>Rated short-time withstand current (Icw)</b>	"Value of short-time withstand current, assigned to the equipment by the manufacturer, that the equipment can carry without damage, under the test conditions specified in the relevant product standard". Generally expressed in kA for 0.5, 1 or 3 seconds. This is an essential characteristic for air circuit breakers. It is not significant for molded-case circuit breakers for which the design targets fast opening and high limiting capacity.
<b>Service breaking capacity (Ics)</b>	Expressed as a percentage of Icu, it provides an indication on the robustness of the device under severe conditions. It is confirmed by a test with one opening and one closing/opening at Ics, followed by a check that the device operates correctly at its rated current, i.e. 50 cycles at In, where temperature rise remains within tolerances and the protection system suffers no damage.
<b>Short-circuit making capacity (Icm)</b>	Value indicating the capacity of the device to make and carry a high current without repulsion of the contacts. It is expressed in kA peak.
<b>Suitability for isolation (see also below Positive contact indication)</b>	<p>This capability means that the circuit breaker meets the conditions below.</p> <ul style="list-style-type: none"> <li>■ In the open position, it must withstand, without flashover between the upstream and downstream contacts, the impulse voltage specified by the standard as a function of the Uimp indicated on the device.</li> <li>■ It must indicate contact position by one or more of the following systems: <ul style="list-style-type: none"> <li>□ position of the operating handle</li> <li>□ separate mechanical indicator</li> <li>□ visible break of the moving contacts</li> </ul> </li> <li>■ Leakage current between each pole, with the contacts open, at a test voltage of 1.1 x the rated operating voltage, must not exceed: <ul style="list-style-type: none"> <li>□ 0.5 mA per pole for new devices</li> <li>□ 2 mA per pole for devices already subjected to normal switching operations</li> <li>□ 6 mA, the maximum value that must never be exceeded.</li> </ul> </li> <li>■ It must not be possible to install padlocks unless the contacts are open. Locking in the closed position is permissible for special applications. ComPact NSX complies with this requirement by positive contact indication.</li> </ul>
<b>Suitable for isolation with positive contact indication (see also above Suitability for isolation)</b>	<p>Suitability for isolation is defined here by the mechanical reliability of the position indicator of the operating mechanism, where:</p> <ul style="list-style-type: none"> <li>■ the isolation position corresponds to the O (OFF) position</li> <li>■ the operating handle cannot indicate the "OFF" position unless the contacts are effectively open.</li> </ul> <p>The other conditions for isolation must all be fulfilled:</p> <ul style="list-style-type: none"> <li>■ locking in the open position is possible only if the contacts are effectively open</li> <li>■ leakage currents are below the standardised limits</li> <li>■ overvoltage impulse withstand between upstream and downstream connections.</li> </ul>
<b>Ultimate breaking capacity (Icu)</b>	Expressed in kA, it indicates the maximum breaking capacity of the circuit breaker. It is confirmed by a test with one opening and one closing/opening at Icu, followed by a check that the circuit is properly isolated. This test ensures user safety.

## Communication.....

<b>Acti 9 Smartlink Ethernet</b>	Acti 9 Smartlink Ethernet collects data from Smartlink Modbus and transfers them via the Ethernet network.
<b>Acti 9 Smartlink Modbus</b>	Acti 9 Smartlink Modbus is used to transfer data from Acti 9 devices to a PLC or monitoring system via the communication system: Modbus serial line.
<b>BSCM (Breaker status and control module)</b>	The optional BSCM for ComPact NSX is used to acquire device status indications and control the communicating remote-control function. It includes a memory used to manage the maintenance indicators. It serves as a converter between the analog outputs of the device indication contacts (O/F, SD, SDE) and the digital communicating functions.
<b>Com'X 210 energy server</b>	<p>Com'X 210 energy server is a compact, plug-and-play data logger that merges seamlessly with the Smart Panels energy management solution. It consolidates inputs from analog environmental sensors (e.g. temperature), digital readers (e.g. pulsed signals from smart energy or water meters, load running hours), and energy management equipment running over the Modbus protocol.</p> <p>Designed for ease of implementation, data can be transmitted securely via Ethernet, Wi-Fi, or GPRS to any energy management platforms. The Com'X 210 energy server is scalable and can be easily adaptable to accommodate future upgrades. Com'X 210 is a perfect fit with our energy management services, enabling visualization, tracking, and analysis of energy data to support optimization of energy performance and cost management.</p>

<b>Ethernet TCP/IP (Transmission Control Protocol / Internet Protocol)</b>	Ethernet is a very common network protocol and complies with IEEE standard 802.3. Ethernet TCP/IP is the protocol that brings web functions to Ethernet networks. Most PCs have an Ethernet 10/100 card (10 or 100 Mbit/s) for connection to the internet. Data communicated from ComPact NSX via Modbus are accessible on a PC via a TCP/IP-Modbus gateway such as MPS100 or EGX100.
<b>FDM121 switchboard display</b>	An FDM121 switchboard display unit can be connected to a ULP IMU using a prefabricated cord to display all measurements, alarms, histories and event tables, maintenance indicators, management of installed devices on a screen. The result is a veritable 96 x 96 mm Power Meter. The FMD121 display unit requires a 24 V DC power supply. The FDM121 is a switchboard display unit that can be integrated in the ComPact NSX100 to 630 A, PowerPact H/J/L/P/R, ComPact NS or MasterPact systems.
<b>FDM128 switchboard display</b>	The FDM128 is an intelligent Ethernet display. It collects the data from up to 8 devices via Ethernet network. The FDM128 is a large display, but requires very little depth. The anti-glare graphic screen is backlit for very easy reading even under poor ambient lighting and at sharp angles.
<b>IFE Ethernet interface, IFE Ethernet interface + gateway</b>	The IFE Ethernet interface for LV circuit breaker enables an intelligent modular unit (IMU), for example a MasterPact NT/NW/MTZ or ComPact NSX circuit breaker to be connected to an Ethernet network.
<b>IFM Module interface Modbus</b>	This module required for connection to the network, contains the Modbus address (1 to 99) declared by the user via the two dials in front. It automatically adapts (baud rate, parity) to the Modbus network in which it is installed. It is equipped with a lock-out switch to enable or disable operations involving writing to MicroLogic, i.e. reset, counter reset, setting modifications, device opening and closing commands, etc. There is a built-in test function to check the connections of the Modbus interface module with the MicroLogic and FDM121 display unit.
<b>I/O application module</b>	The I/O (Input/Output) application module for LV breaker is part of an ULP system with built-in functionalities and applications to enhance the application needs. The ULP system architecture can be built without any restrictions using the wide range of circuit breakers. The I/O application module is compliant with the ULP system specifications. Two I/O application modules can be connected in the same ULP network.
<b>Network</b>	Set of communicating devices that are interconnected by communication lines in order to share data and resources.
<b>Open protocol</b>	A protocol for system communication, interconnection or data exchange for which technical specifications are public, i.e. there are no restrictions on access or implementation. An open protocol is the opposite of a proprietary protocol.
<b>Protocol</b>	Standardised specification for dialog between digital components that exchange data. It is an operating mode based on the length and structure of binary words and it must be used by all the components exchanging data between themselves. Communication is not possible without using a protocol.
<b>RJ45 connector</b>	Universal, 8-wire connector that is widely used in digital communication networks. The RJ45 connector is used to interconnect computer equipment (Ethernet, Modbus, etc.), telephones and audiovisual equipment.
<b>RS485 Modbus</b>	Modbus is the most widely used communication protocol in industrial networks. It operates in master-slave mode. An RS485 multipoint link connects the master and slaves via a pair of wires offering throughputs of up to 38400 bits/second over distances up to 1200 m). The master cyclically polls the slaves which send back the requested information. The Modbus protocol uses frames containing the address of the targeted slave, the function (read, write), the datum and the CRC (cyclical redundancy check).
<b>SDTAM</b>	Relay module with two static outputs specifically for the motor-protection MicroLogic trip units 1 M, 2 M and 6 E-M. An output, linked to the contactor controller, opens the contactor when an overload or other motor fault occurs, thus avoiding opening of the circuit breaker. The other output stores the opening event in memory.
<b>SDx</b>	Relay module with two outputs that remotes the trip or alarm conditions of ComPact NSX circuit breakers equipped with a MicroLogic electronic trip unit.
<b>Static output</b>	Output of a relay made up of a thyristor or triac electronic component. The low switching capability means that a power relay is required. This is the case for the SDx and SDTAM outputs.
<b>ULP (Universal Logic Plug)</b> 	Connection system used by ComPact NSX to communicate information to the Modbus interface via a simple RJ45 cable. Compatible modules are indicated by the symbol opposite.

# Glossary

## Components

### ASIC (Application Specific Integrated Circuit)

Integrated circuit designed, built and intended for a specific application. It carries out repetitive sequences of instructions engraved in the silicon chip. For that reason, it is extremely reliable because it cannot be modified and is not affected by environment conditions.

MicroLogic trip units use an ASIC for the protection functions. The ASIC cyclically polls the network status at a high frequency, using the values supplied by captors. Comparison with the settings forms the basis for orders to the electronic trip units.

### Microprocessor

A microprocessor is a more general purpose device than an ASIC. In MicroLogic, a microprocessor is used for measurements and it can be programmed. It is not used for the main protection functions that are carried out by the ASIC.

## Controls

### Communicating motor mechanism

For ComPact NSX remote control via the communication system, a communicating motor mechanism is required. Except for the communication function, it is identical to the standard motor mechanism module and connects to and controlled by the BSCM module.

### CNOMO machine-tool rotary handle

Handle used for machine-tool control enclosures and providing IP54 and IK08.

### Direct rotary handle

This is an optional control handle for the circuit breaker. It has the same three positions I (ON), O (OFF) and TRIPPED as the toggle control. It provides IP40, IK07 and the possibility, due to its extended travel, of using early-make and early-break contacts. It maintains suitability for isolation and offers optional locking using a keylock or a padlock.

### Emergency off

In a circuit equipped with a circuit breaker, this function is carried out by an opening mechanism using an MN undervoltage release or an MX shunt release in conjunction with an emergency off button.

### Extended rotary handle

Rotary handle with an extended shaft to control devices installed at the rear of switchboards. It has the same characteristics as direct rotary handles. It offers multiple locking possibilities using a keylock, a padlock or a door interlock.

### Failsafe remote tripping

Remote tripping is carried out by an opening mechanism using an MN undervoltage release in conjunction with an emergency off button. If power is lost, the protection device opens the circuit breaker.

### Manual toggle control

This is the standard control mechanism for the circuit breaker, with a toggle that can be flipped up or down. In a molded-case circuit breaker (MCCB), there are three positions, I (ON), O (OFF) and TRIPPED. Once in the TRIPPED position, manual reset is required by switching to O (OFF position before reclosing. The TRIPPED position does not offer isolation with positive contact indication. This is guaranteed only by the O (OFF) position.

### MCC rotary handle

Handle used for motor control centres and providing IP43 and IK07.

### Motor mechanism module

The optional motor mechanism module is used to remotely open, close and recharge the circuit breaker.

## Selectivity / Cascading

### Cascading

Cascading implements the current-limiting capacity of a circuit breaker, making it possible to install downstream circuit breakers with lower performance levels. The upstream circuit breaker reduces any high short-circuit currents. This makes it possible to install downstream circuit breakers with breaking capacities less than the prospective short-circuit current at their point of installation. The main advantage of cascading is to reduce the overall cost of switchgear. Because the current is limited throughout the circuit downstream of the limiting circuit breaker, cascading applies to all the devices located downstream.

### Current selectivity

Selectivity based on the difference between the current-protection settings of the circuit breakers. The difference in settings between two successive circuit breakers in a circuit must be sufficient to allow the downstream breaker to clear the fault before the upstream breaker trips.



<b>Selectivity</b>	Selectivity is ensured between upstream and downstream circuit breakers if, when a fault occurs, only the circuit breaker placed immediately upstream of the fault trips. Selectivity is the key to ensuring the continuity of service of an installation.
<b>Energy selectivity</b>	This function is specific to ComPact NSX (see Reflex tripping on page G-7) and supplements the other types of selectivity.
<b>Partial selectivity</b>	Selectivity is partial if the conditions for total selectivity are not met up to the ultimate short-circuit current I <sub>cu</sub> , but only up to a lesser value. This value is called the selectivity limit. If a fault exceeds the selectivity limit, both circuit breakers trip.
<b>Time selectivity</b>	Selectivity based on the difference between the time-delay settings of the circuit breakers. The upstream trip unit is delayed to provide the downstream breaker the time required to clear the fault.
<b>Total selectivity</b>	Total selectivity is ensured between upstream and downstream circuit breakers if, for all fault values, from overloads up to solid short-circuits, only the downstream circuit breaker trips and the upstream circuit breaker remains closed.
<b>Zone selective interlocking (ZSI)</b>	A number of circuit breakers with MicroLogic electronic trip units are interconnected one after another by a pilot wire. In the event of a short-time or ground fault: <ul style="list-style-type: none"> <li>■ in the absence of information from downstream, the circuit breaker directly concerned by the fault (i.e. located just upstream of the fault) shifts to the shortest time delay and sends a signal upstream</li> <li>■ the upstream device, on receiving the signal from the downstream device, maintains its normal time delay.</li> </ul> In this manner, the fault is cleared rapidly by the circuit breaker closest to the fault.

Environment.....

<b>EMC (Electromagnetic compatibility)</b>	EMC is the capacity of a device not to disturb its environment during operation (emitted electromagnetic disturbances) and to operate in a disturbed environment (electromagnetic disturbances affecting the device). The standards define various classes for the types of disturbances. MicroLogic trip units comply with annexes F and J in standard IEC IE60947-2.
<b>Power loss Pole resistance</b>	The flow of current through the circuit-breaker poles produces Joule-effect losses caused by the resistance of the poles.
<b>Product environmental profile (PEP) LCA: Life-cycle assessment ISO 14040</b>	<p>An assessment on the impact of the construction and use of a product on the environment, in compliance with standard ISO 14040, Environmental management, life-cycle assessment (LCA), principles and framework.</p> <p>For ComPact NSX, this assessment is carried out using the standardised EIME (Environmental Impact and Management Explorer) software, which makes possible comparisons between the products of different manufacturers.</p> <p>It includes all stages, i.e. manufacture, distribution, use and end of life, with set usage assumptions:</p> <ul style="list-style-type: none"> <li>■ use over 20 years at a percent load of 80% for 14 hours per day and 20% for ten hours</li> <li>■ according to the European electrical-energy model.</li> </ul> <p>It provides the information presented below.</p> <ul style="list-style-type: none"> <li>■ Materials making up the product: composition and proportions, with a check to make sure no substances forbidden by the RoHS directive are included.</li> <li>■ Manufacture: on Schneider Electric production sites that have set up an environmental management system certified ISO 14001.</li> <li>■ Distribution: packaging in compliance with the 94/62/EC packaging directive (optimised volumes and weights) and optimised distribution flows via local centres.</li> <li>■ Use: no aspects requiring special precautions for use. Power lost through Joule effect in Watts (W) must be &lt; 0.02% of total power flowing through the circuit breaker. Based on the above assumptions, annual consumption from 95 to 200 kWh.</li> <li>■ End of life: products dismantled or crushed. For ComPact NSX, 81% of materials can be recycled using standard recycling techniques. Less than 2% of total weight requires special recycling.</li> </ul>



# Glossary

<p><b>Product environmental profile (PEP)</b> <b>Environmental indicators</b></p>	<p>Environmental indicators are also frequently used for the PEP (sheet available on request for ComPact NSX):</p> <ul style="list-style-type: none"> <li>■ Depletion of natural resources</li> <li>■ Depletion of energy</li> <li>■ Depletion of water</li> <li>■ Potential for atmospheric warming (greenhouse effect)</li> <li>■ Potential for stratospheric ozone depletion</li> <li>■ Creation of atmospheric ozone (ozone layer)</li> <li>■ Acidification of air (acid rain)</li> <li>■ Production of hazardous waste.</li> </ul>
<p><b>RoHS directive (Restriction of Hazardous substances)</b></p>	<p>European directive 2002/95/EC dated 27 January 2003 aimed at reducing or eliminating the use of hazardous substances. The manufacturer must attest to compliance, without third-party certification. Circuit breakers are not included in the list of concerned products, which are essentially consumer products. That notwithstanding, Schneider Electric decided to comply with the RoHS directive. ComPact NSX products are designed in compliance with RoHS and do not contain (above the authorised levels) lead, mercury, cadmium, hexavalent chromium or flame retardants (polybrominated biphenyls PBB and polybrominated diphenyl ether PBDE).</p>
<p><b>Safety clearances</b></p>	<p>When installing a circuit breaker, minimum distances (safety clearances) must be maintained between the device and panels, bars and other protection systems installed nearby. These distances, which depend on the ultimate breaking capacity, are defined by tests carried out in accordance with standard IEC 60947-2.</p>
<p><b>Temperature derating</b></p>	<p>An ambient temperature varying significantly from 40°C can modify operation of magnetic or thermal-magnetic protection functions. It does not affect electronic trip units. However, when electronic trip units are used in high-temperature situations, it is necessary to check the settings to ensure that only the permissible current for the given ambient temperature is let through.</p>
<p><b>Vibration withstand IEC 60068-2-6</b></p>	<p>Circuit breakers are tested in compliance with standard IEC 60068-2-6 for the levels required by merchant-marine inspection organisations (Veritas, Lloyd's, etc.):</p> <ul style="list-style-type: none"> <li>■ 2 to 13.2 Hz: amplitude of ±1 mm</li> <li>■ 13.2 to 100 Hz: constant acceleration of 0.7 g.</li> </ul>
<p><b>WEEE directive (Waste of Electrical and Electronic Equipment)</b></p>	<p>European directive on managing the waste of electrical and electronic equipment. Circuit breakers are not included in the list of concerned products. However, ComPact NSX products respect the WEEE directive.</p>

## Harmonics.....



<p><b>Current harmonics</b></p>	<p>Non-linear loads cause harmonic currents that flow in the 50 Hz (or 60 Hz) distribution system. Total harmonic current is the sum of sinusoidal AC currents for which the rms values can be measured and broken down into:</p> <ul style="list-style-type: none"> <li>■ the fundamental current at the 50/60 Hz frequency of the distribution system, with an rms value of <math>I_{H_1}</math></li> <li>■ harmonic currents with whole, odd multiples (3, 5, 7, etc.) of the 50/60 Hz frequency, called the third-order, fifth-order, etc. harmonics. For example, <math>I_{H_3}</math>, the third-order harmonic at 150/180 Hz, <math>I_{H_5}</math>, the fifth-order harmonic at 250/300 Hz, etc. The presence of harmonics in the system must be monitored and limited because it results in temperature rise, currents in the neutral (caused by the third-order harmonics and multiples), malfunctions of sensitive electronic devices, etc. MicroLogic E trip units take into account harmonics up to order 15 in the THDI and THDU calculations.</li> </ul>
<p><b>Non-linear load</b></p>	<p>Systems producing harmonics are present in all industrial, commercial and residential sectors. Harmonics are caused by non-linear loads. A load is said to be non-linear when the current drawn does not have the same waveform as the supply voltage. Typically, loads using power electronics are non-linear. Examples of non-linear loads include computers, rectifiers, variable-speed drives, arc furnaces and fluorescent lighting.</p>
<p><b>Total harmonic distortion of current (THDI)</b></p>	<p>THDI characterises the distortion of the current wave by harmonics. It indicates the quantity of harmonics in the resulting waveform. It is expressed in percent. The higher the THDI, the more the current is distorted by harmonics. THDI should remain below 10%. Above that level, there is said to be harmonic pollution that is considered severe when it rises above 50%.</p>

<b>Total harmonic distortion of voltage (THDU)</b>	THDU characterises the distortion of the voltage wave by harmonics. It indicates the quantity of harmonics in the resulting waveform. It is expressed in percent. The higher the THDU, the more the system voltage is distorted by harmonics. It is advised not to exceed 5% for low-voltage systems.
<b>Voltage harmonics</b>	For each current harmonic $I_{Hk}$ , there is a voltage harmonic $U_{Hk}$ of the same order $k$ , where the resulting voltage is the sum of the two waves. The voltage wave is therefore distorted with respect to the standard sinusoidal wave.

## Measurements .....

<b>Contact wear</b>	Each time ComPact NSX opens, the MicroLogic 5 / 6 trip unit measures the interrupted current and increments the contact-wear indicator as a function of the interrupted current, according to test results stored in memory.
<b>Current transformer with iron-core toroid</b>	It is made up of a coil wound around an iron frame through which a power busbar runs. The current flowing in the bar, on passing through the sensor, induces a magnetic field that reverses for each half period. This variation in the field in turn creates an induced current in the coil. This current is proportional to the current flowing in the bar. It is sufficient to supply the measurement electronics. The disadvantage of iron-core measurement current transformers (CT) is that they rapidly saturate for currents $> 10 I_n$ .
<b>Current transformer with Rogowski toroid or air-core CT</b>	It is made up of a coil without an iron frame, through which a power busbar runs. The output voltage at the coil terminals is proportional to the current flowing through the bar. The result is a current transformer (CT) with a voltage output. The advantage is that it never saturates whatever the primary current and thus enables measurement of high currents. The output is however a very low current that is too low to supply the measurement electronics. For MicroLogic, Rogowski CTs measure the current and a second CT, with an iron core, provides the electrical supply.
<b>Demand current, demand power and peak values</b>	Average of the instantaneous current or power values over an adjustable fixed or sliding time interval. The highest value observed over the time interval is the peak value. The time interval runs from the last reset.
<b>Instantaneous current</b>	True rms value of the current measured by the current transformers over a sliding time interval. Available on MicroLogic 5/6 A or E.
<b>Instantaneous voltage</b>	True rms value of the voltage measured by the voltage sensors over a sliding time interval. Available on MicroLogic 5/6 A or E.
<b>Maximeters/minimeters</b>	MicroLogic 5 and 6 A or E can record the minimum and maximum values of electrical parameters over set time periods.
<b>Overvoltage category (OVC - Overvoltage category) IEC 60947-1. Annex H</b>	Standard IEC 60664-1 stipulates that it is up to the user to select a measurement device with a sufficient overvoltage category, depending on the network voltage and the transient overvoltages likely to occur. Four overvoltage categories define the field of use for a device. <ul style="list-style-type: none"> <li>■ Cat. I. Devices supplied by a SELV isolating transformer or a battery.</li> <li>■ Cat. II. Residential distribution, handheld or laboratory tools and devices connected to standardised 2P + earth electrical outlets (230 V).</li> <li>■ Cat. III. Industrial distribution, fixed distribution circuits in buildings (main low voltage switchboards, rising mains, elevators, etc.).</li> <li>■ Cat. IV. Utility substations, overhead lines, certain industrial equipment.</li> </ul>
<b>Percent load</b>	Percentage of current flowing through the circuit breaker with respect to its rated current. MicroLogic 6 E-M offers this information and can sum it over the total operating time to provide the load profile for the following ranges, 0 to 49%, 50 to 79%, 80 to 89% and $\geq 90\%$ .
<b>Phase sequence</b>	The order in which the phases are connected (L1, L2, L3 or L1, L3, L2) determines the direction of rotation for three-phase asynchronous motors. MicroLogic 6 E-M trip units provide this information.
<b>Power and energy metering (consumption)</b>	The digital electronics in MicroLogic 5/6 E calculate the instantaneous power levels, apparent (S in kVA), active (P in kW) and (Q in kV), and integrate over a time interval to determine the corresponding energies (kVAh, kWh kvarh). Calculations are for each phase and for the total.

# Glossary

## Time-stamped histories

MicroLogic trip units store information on events (e.g. alarms and their cause) that are time-stamped to within a millisecond.

## Protection .....

### Ground-fault protection G (Ig)

Protection function specific to electronic circuit breakers, symbolised by G (Ground). This protection can calculate high-threshold residual earth-leakage currents (in the order of tens of Amperes) on the basis of phase-current measurements. MicroLogic 5/6 offers this protection function with adjustable pick-up Ig and time delay.

### Instantaneous protection I (Ii)

This protection supplements Isd. It provokes instantaneous opening of the device. The pick-up may be adjustable or fixed (built-in). This value is always lower than the contact-repulsion level.

### Long-time protection L (Ir)

Protection function where the adjustable Ir pick-up determines a protection curve similar to the thermal-protection curve (inverse-time curve  $I^2t$ ). The curve is generally determined on the basis of the Ir setting which corresponds to a theoretically infinite tripping time (asymptote) and of the point at 6 Ir at which the tripping time depends on the rating.

### Magnetic protection (Im)

Short-circuit protection provided by magnetic trip units (see this term). The pick-up setting may be fixed or adjustable.

### Neutral protection (IN)

The neutral is protected because all circuit-breaker poles are interrupted. The setting may be that used for the phases or specific to the neutral, i.e. reduced neutral (0.5 times the phase current) or OSN (oversized neutral) at 1.6 times the phase current. For OSN protection, the maximum device setting is limited to 0.63 In.

### Residual-current earth-leakage protection (IAN)

Protection provided by Vigi add-on, in which the residual-current toroids directly detect low-threshold earth-leakage currents (in the order of tens of mA) caused by insulation faults.

### Short-delay protection S (Isd)

Protection function specific to electronic circuit breakers, symbolised by S (Short delay or short time). This protection supplements thermal protection. The reaction time is very short, but has a slight time delay to enable selectivity with the upstream device. The short-delay pick-up Isd is adjustable from approximately 1.5 to 10 Ir.

### Short-delay protection with fixed time delay So (Isd)

Short-delay protection, but with a fixed time delay. This function is available on MicroLogic 2. It is symbolised by So. It ensures selectivity with downstream devices.

### Thermal protection (Ir)

Overload protection provided by thermal trip units (see this term) using an inverse-time curve ( $I^2t$ ).

## Relays and auxiliary contacts .....

### Auxiliary contact IEC 60947-1

"Contact included in an auxiliary circuit and mechanically operated by the switching device".

### Break contact IEC 60947-1

"Control or auxiliary contact which is open when the main contacts of the mechanical switching device are closed and closed when they are open".

### Make contact IEC 60947-1

"Control or auxiliary contact which is closed when the main contacts of the mechanical switching device are closed and open when they are open".

### Relay (electrical) IEC 60947-1

"Device designed to produce sudden, predetermined changes in one or more electrical output circuits when certain conditions are fulfilled in the electrical input circuits controlling the device".

### Relay module with static output

Output of a relay made up of a thyristor or triac electronic component. The low interrupting capacity means that a power relay is required. This is the case for the SDx and SDTAM outputs.

## Switchgear .....

**Circuit breaker**  
IEC 60947-2



"Mechanical switching device, capable of making, carrying and breaking currents under normal circuit conditions and also making, carrying for a specified time and breaking currents under specified abnormal circuit conditions such as those of short circuit". Circuit breakers are the device of choice for protection against overloads and short-circuits. Circuit breakers may, as is the case for ComPact NSX, be suitable for isolation.

**Circuit-breaker utilisation category**  
IEC 60947-2

The standard defines two utilisation categories, A and B, depending on breaker selectivity with upstream breakers under short-circuit conditions.

- Category A. Circuit breakers not specifically designed for selectivity applications.
- Category B. Circuit breakers specifically designed for selectivity, which requires a short time-delay (which may be adjustable) and a rated short-time withstand current in compliance with the standard.

ComPact NSX100 to 630 circuit breakers are category A, however, by design, they provide selectivity with downstream devices (see the Complementary technical information guide).

**Contactor**  
IEC 60947-1



"Mechanical switching device having only one position of rest, operated otherwise than by hand, capable of making, carrying and breaking currents under normal circuit conditions including operating overload conditions". A contactor is provided for frequent opening and closing of circuits under load or slight overload conditions. It must be combined and coordinated with a protective device against overloads and short-circuits, such as a circuit breaker.

**Contactor utilisation categories**  
IEC 60947-4-1

The standard defines four utilisation categories, AC1, AC2, AC3 and AC4 depending on the load and the control functions provided by the contactor. The class depends on the current, voltage and power factor, as well as contactor withstand capacity in terms of frequency of operation and endurance.

**Current-limiting circuit breaker**  
IEC 60947-2

"A circuit-breaker with a break-time short enough to prevent the short-circuit current reaching its otherwise attainable peak value".

**Disconnecter**  
IEC 60947-3

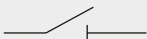

"Mechanical switching device which, in the open position, complies with the requirements specified for the isolating function". A disconnector serves to isolate upstream and downstream circuits. It is used to open or close circuits under no-load conditions or with a negligible current level. It can carry the rated circuit current and, for a specified time, the short-circuit current.

**Switch-disconnector**  
IEC 60947-3



"Switch which, in the open position, satisfies the isolating requirements specified for a disconnector". A switch-disconnector serves for switching and isolation. The switch function breaks the circuit under load conditions and the disconnection function isolates the circuit. Protection is not provided. It may be capable of making short-circuit currents if it has the necessary making capacity, but it cannot break short-circuit currents. ComPact NSX100 to 630 NA switch-disconnectors have a making capacity.

**Switch-disconnector utilisation category**  
IEC 60947-3

The standard defines six utilisation categories, AC-21A or B, AC-22 A or B, AC23 A or B. They depend on the rated operational current and the mechanical durability (A for frequent operation or B for infrequent operation). ComPact NSX NA switch-disconnectors comply with utilisation categories AC22A or AC23A.



## Three-phase asynchronous motors and their protection .....

**Locked-rotor protection (Ijam)**

This function steps in when the motor shaft cannot or can no longer drive the load. The result is a high overcurrent.

**Long-start protection (Ilong)**

An overly long start means the current drawn remains too high or too low for too long, with respect to the starting current. In all cases, the load cannot be driven and the start must be interrupted. The resulting temperature rise must be taken into account before restarting.

**Phase-unbalance or phase- loss protection (Iunbal)**

This protection function steps in if the current values and/or the unbalance in the three phases supplying the motor exceeds tolerances. Currents should be equal and displacement should be one third of a period. Phase loss is a special case of phase unbalance.

# Glossary

<b>Starting current</b>	Start-up of a three-phase, asynchronous motor is characterised by: <ul style="list-style-type: none"> <li>■ a high inrush current, approximately 14 I<sub>n</sub> for 10 to 15 ms</li> <li>■ a starting current, approximately 7.2 I<sub>n</sub> for 5 to 30 seconds</li> <li>■ return to the rated current after the starting time.</li> </ul>
<b>Starting time</b>	Time after which the motor ceases to draw the starting current and falls back to the operating current I <sub>r</sub> (≤ I <sub>n</sub> ).
<b>Thermal image of the rotor and stator</b>	The thermal image models the thermal behaviour of a motor rotor and stator, taking into account temperature rise caused by overloads or successive starts, and the cooling constants. For each motor power rating, the algorithm takes into account a theoretical amount of iron and copper which modifies the cooling constants.
<b>Thermal protection</b>	Protection against overcurrents following an inverse time curve I <sup>2</sup> t = constant, which defines the maximum permissible temperature rise for the motor. Tripping occurs after a time delay that decreases with increasing current.
<b>Trip class IEC 60947-4-1</b>	The trip class determines the trip curve of the thermal protection device for a motor feeder. The standard defines trip classes 5, 10, 20 and 30. These classes are the maximum durations, in seconds, for motor starting with a starting current of 7.2 I <sub>r</sub> , where I <sub>r</sub> is the thermal setting indicated on the motor rating plate.
<b>Under-load protection (Iund)</b>	This function steps in when the driven load is too low. It detects a set minimum phase current which signals incorrect operation of the driven machine. In the example of a pump, under-load protection detects when the pump is no longer primed.

## Trip units

<b>Electronic trip unit (MicroLogic)</b>	Trip unit that continuously measures the current flowing through each phase and the neutral if it exists. For MicroLogic, the measurements are provided by built-in current sensors linked to an analog-digital converter with a high sampling frequency. The measurement values are continuously compared by the ASIC to the protection settings. If a setting is overruled, a Mitop release trips the circuit-breaker operating mechanism. This type of trip unit offers much better pick-up and delay setting accuracy than thermal-magnetic trip units. It also provides a wider range of protection functions.
<b>Magnetic release</b>	Release actuated by a coil or a lever. A major increase in the current (e.g. a short-circuit) produces in the coil or the lever a change in the magnetic field that moves a core. This trips the circuit breaker operating mechanism. Action is instantaneous. The pick-up setting may be adjustable.
<b>Reflex tripping</b>	ComPact NSX circuit breakers have a patented reflex-tripping system based on the energy of the arc and that is independent of the other protection functions. It operates extremely fast, before the other protection functions. It is an additional safety function that operates before the others in the event of a very high short-circuit.
<b>Release IEC 60947-1</b>	Device, mechanically connected to a mechanical switching device (e.g. a circuit breaker), which releases the holding means and permits the opening or the closing of the switching device. For circuit breakers, releases are often integrated in a trip unit.
<b>Shunt release (MX)</b>	This type of release operates when supplied with current. The MX release provokes circuit-breaker opening when it receives a pulse-type or maintained command.
<b>Thermal-magnetic trip unit</b>	Trip unit combining thermal protection for overloads and magnetic protection.
<b>Thermal release</b>	Release in which a bimetal strip is heated by the Joule effect. Above a temperature-rise threshold that is a function of the current and its duration (I <sup>2</sup> t curve = constant, which is representative of temperature rise in cables), the bimetal strip bends and releases the circuit-breaker opening mechanism. The pick-up setting may be adjustable.
<b>Undervoltage release (MN)</b>	This type of release operates when the supply voltage drops below the set minimum.

## Additional characteristics

### ComPact NSXm up to 160 A

TMD magnetic trip units, tripping curves	
Protection of distribution systems .....	H-2
MicroLogic Vigi 4.1, tripping curves	
Protection of distribution systems .....	H-4

### ComPact NSX100 to 250

TMD magnetic trip units, tripping curves	
Protection of distribution systems .....	H-5
MicroLogic 2.2, 4.2 and 2.2 G electronic trip units, tripping curves - Protection of distribution systems .....	H-11
MicroLogic 5.2 and 6.2 A or E and 7.2 E electronic trip units, tripping curves - Protection of distribution systems .....	H-12
MA magnetic trip units, MicroLogic 2.2 M electronic trip units, tripping curves - Motor protection .....	H-13
MicroLogic 6.2 E-M electronic trip units, tripping curves	
Motor protection .....	H-14

### ComPact NSX400 to 630

MicroLogic 2.3, 4.3, 5.3 and 6.3 A or E and 7.3 E electronic trip units, tripping curves - Protection of distribution systems.....	H-15
MicroLogic 6.3 A or E and 7.3 E electronic trip units, tripping curves - Protection of distribution systems .....	H-16
MicroLogic 1.3 M and 2.3 M electronic trip units, tripping curves - Motor protection .....	H-17
MicroLogic 6.3 E-M electronic trip units, tripping curves	
Motor protection .....	H-18

### Tripping curves ComPact NSXm and NSX..... H-19

### Current and energy limiting curves..... H-20

ComPact NSXm .....	H-21
ComPact NSX .....	H-22

#### Other chapters

Select your circuit breakers and switch-disconnectors .....	A-1
Select your protection .....	B-1
Customize your circuit breaker with accessories .....	C-1
Smart Panel integration .....	D-1
Switchboard integration .....	E-1
Catalog numbers .....	F-1
Glossary .....	G-1



# ComPact NSXm up to 160 A

## TMD magnetic trip units, tripping curves

### Protection of distribution systems

TM16D

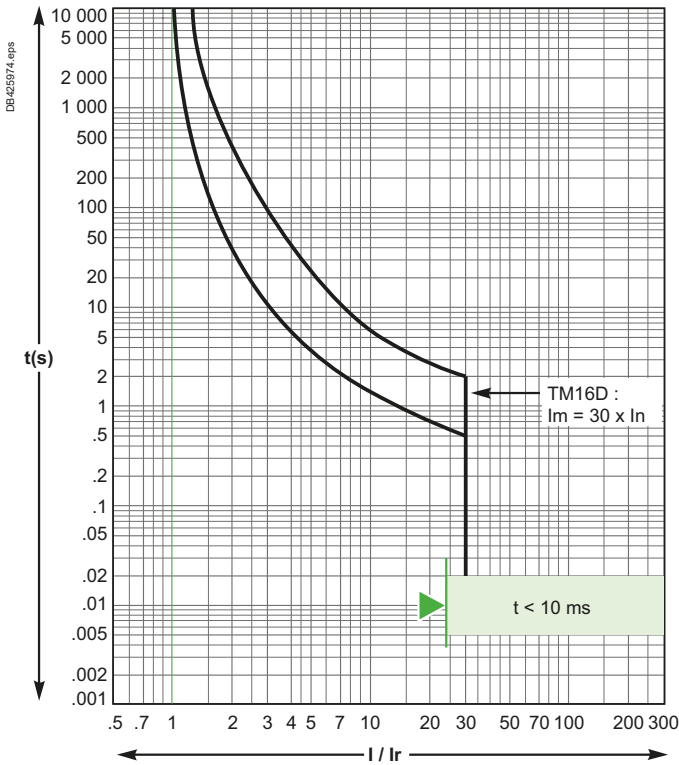

TM25D

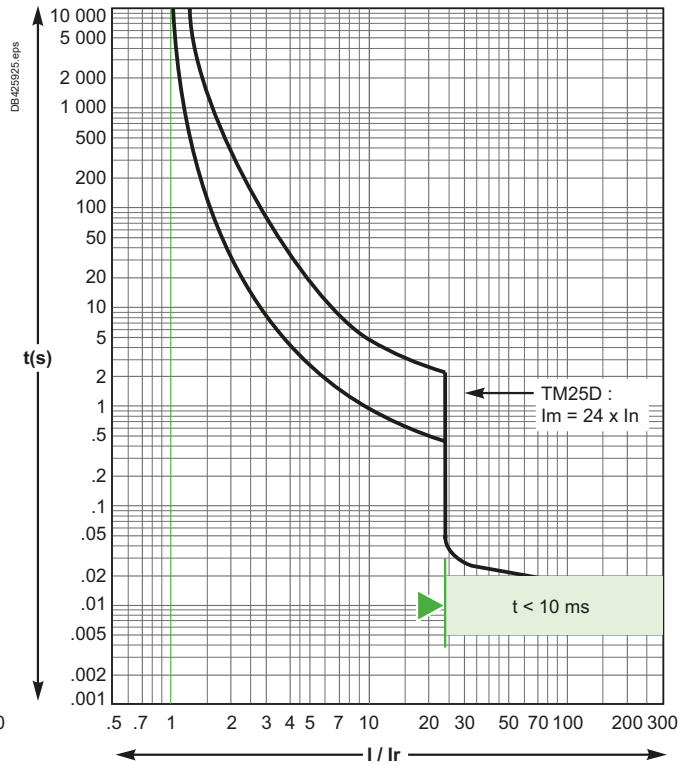

TM32D / TM40D

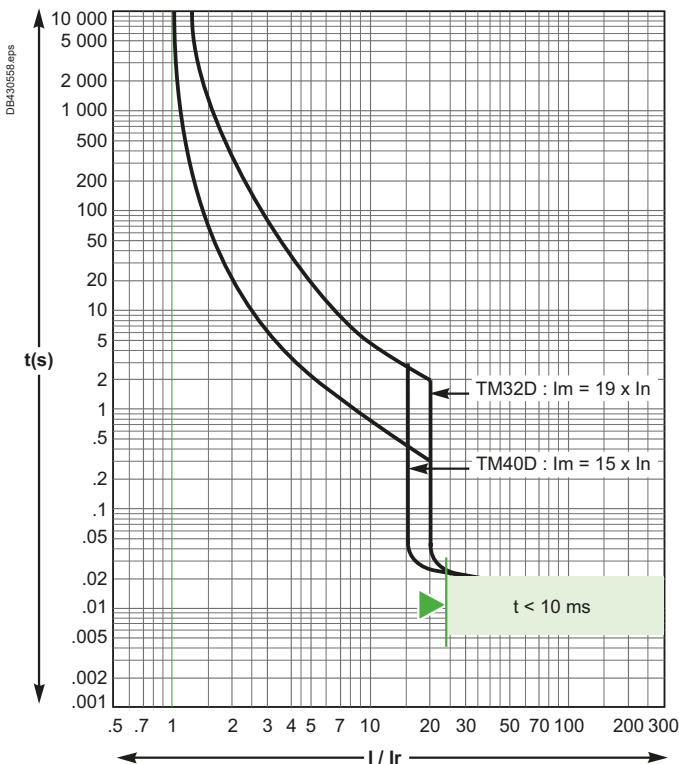

TM50D / TM63D

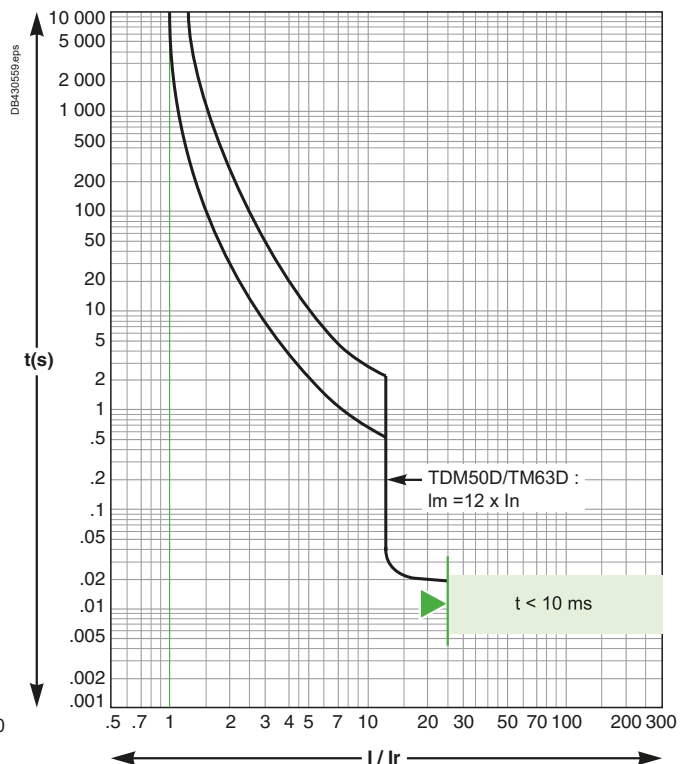

H



# ComPact NSXm up to 160 A

## TMD magnetic trip units, tripping curves

### Protection of distribution systems

TM80D / TM100D

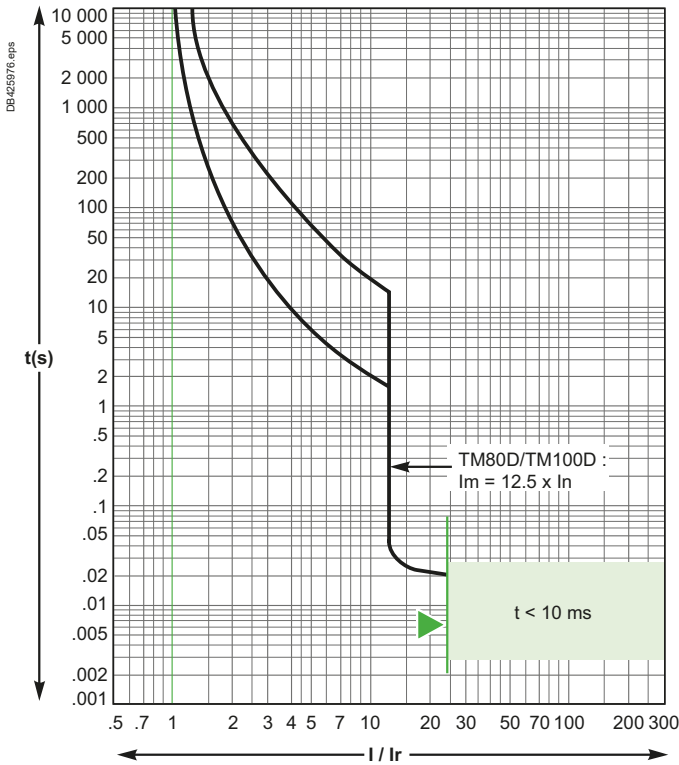

TM125D / TM160D

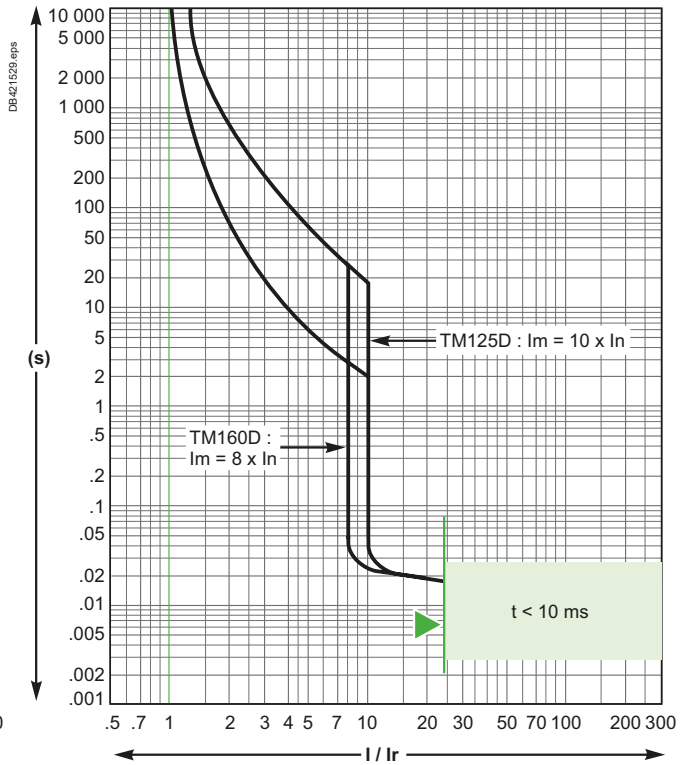

Reflex tripping.

For all TMD curves :  
 Values are given for 40 °C ambient,  $I_r = 1 \times I_n$ , 3 poles loaded, cold start.  
 For  $I_r = k \times I_n$ , read the time corresponding to  $1/k$  times given current.  
 For 1 pole tripping, read the time corresponding to 0.85 times given current.  
 For hot start ( $0.9 \times I_r$ ), divide max. time by 2, min. time by 4.



# ComPact NSXm up to 160 A

## MicroLogic Vigi 4.1, tripping curves

### Protection of distribution systems

25 A

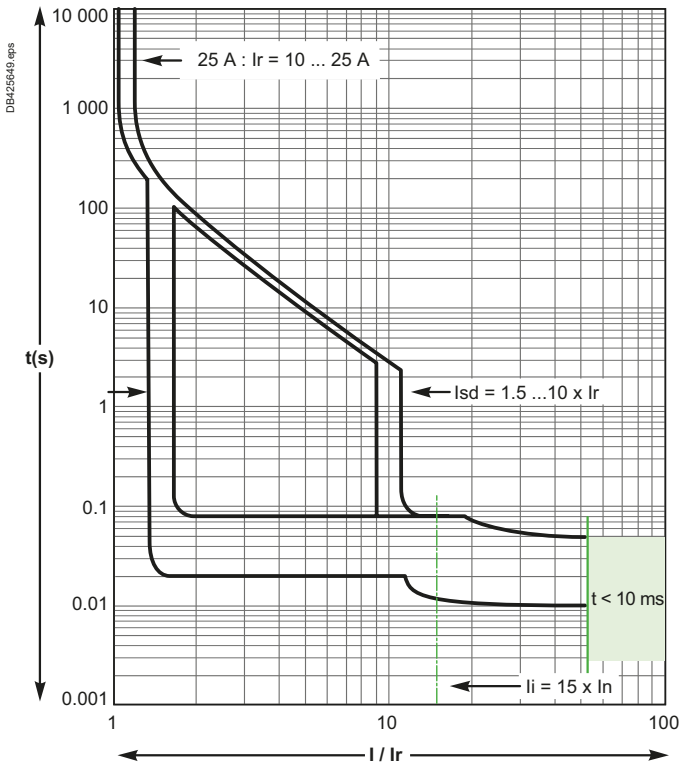

50 A

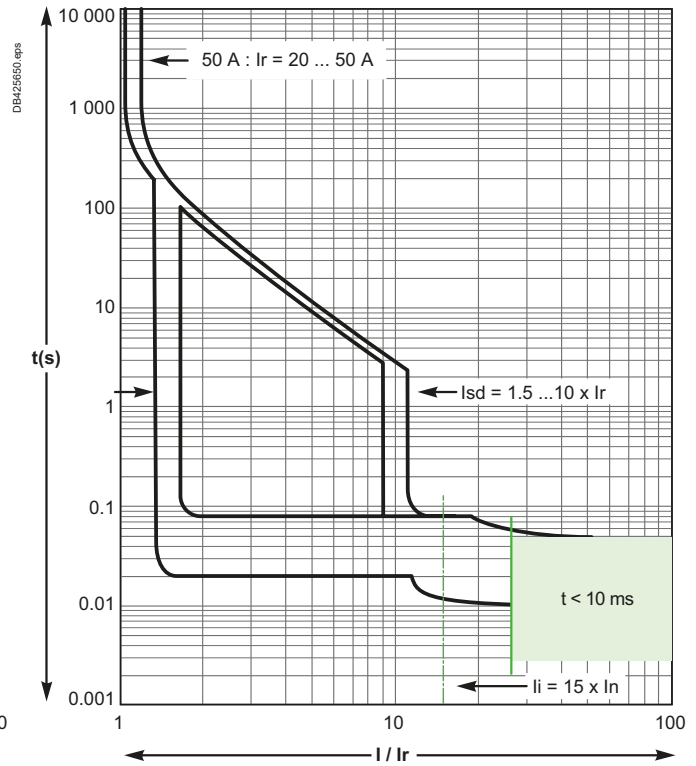

100 A

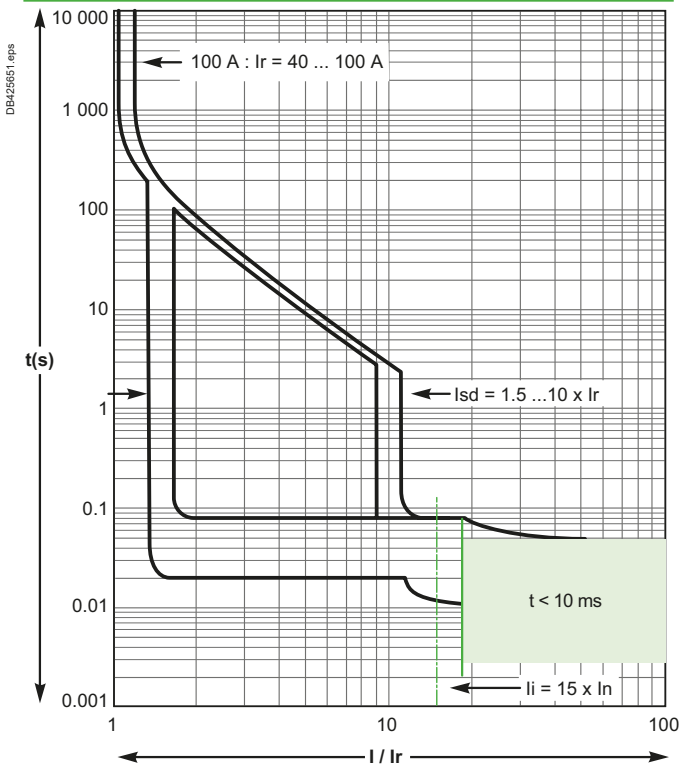

160 A

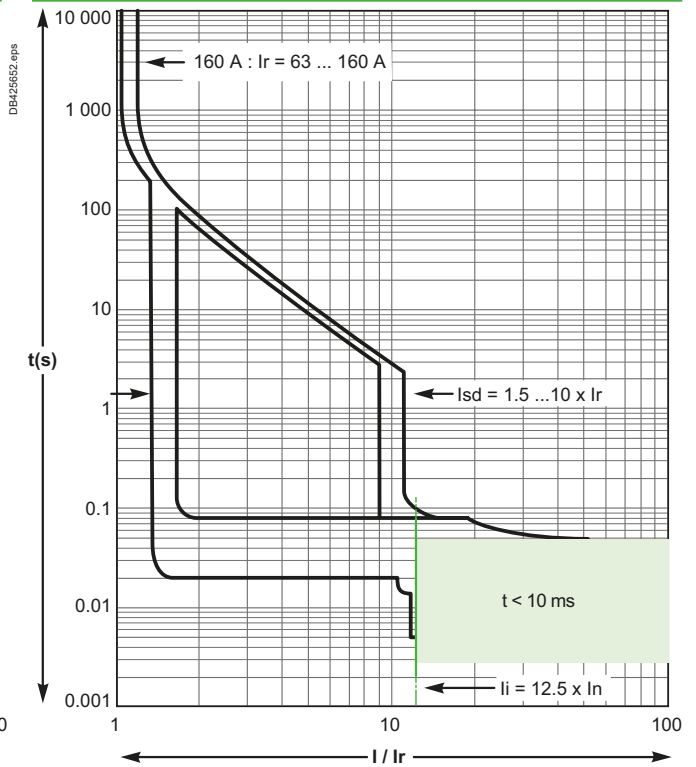

Reflex tripping.

H

# ComPact NSX100 to 250

## TMD magnetic trip units, tripping curves

### Protection of distribution systems

TM16D

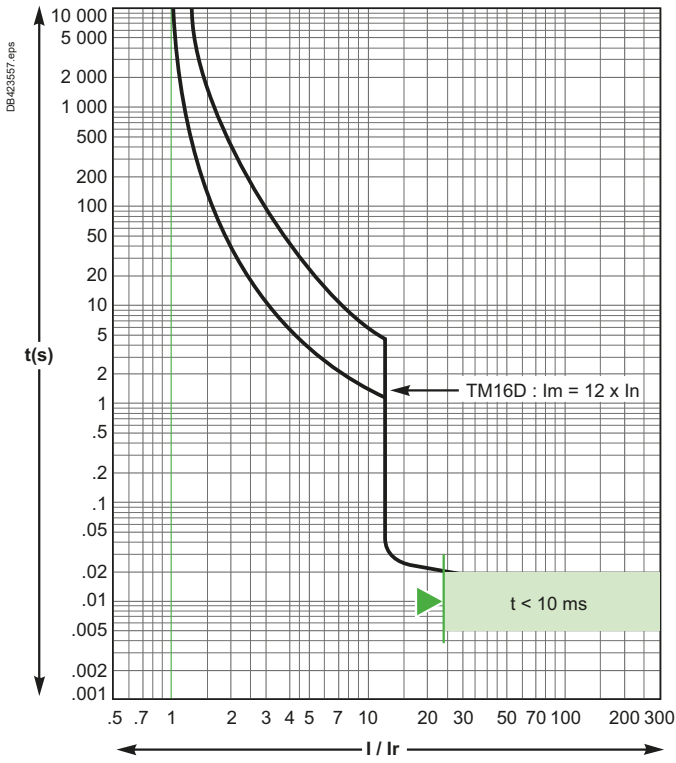

TM25D

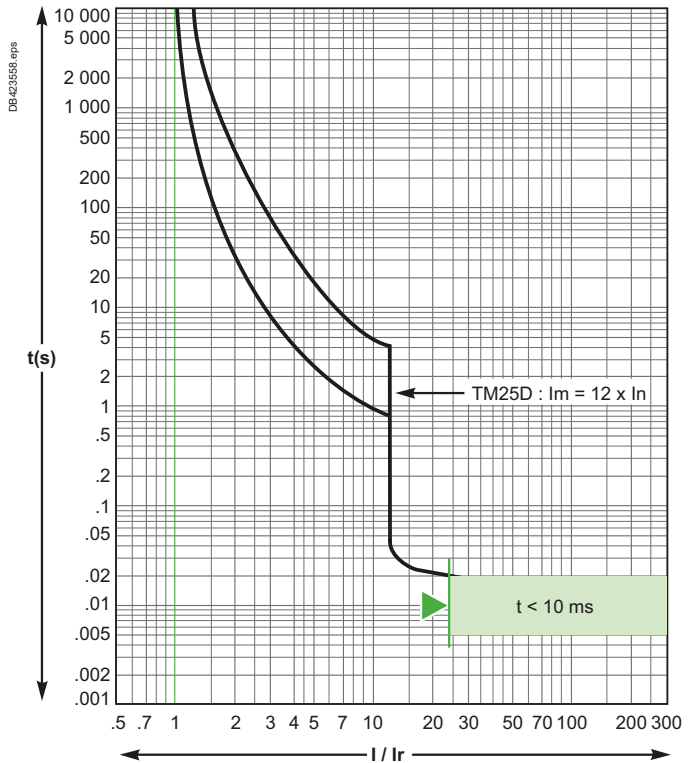

Reflex tripping.

TM30D / TM32D

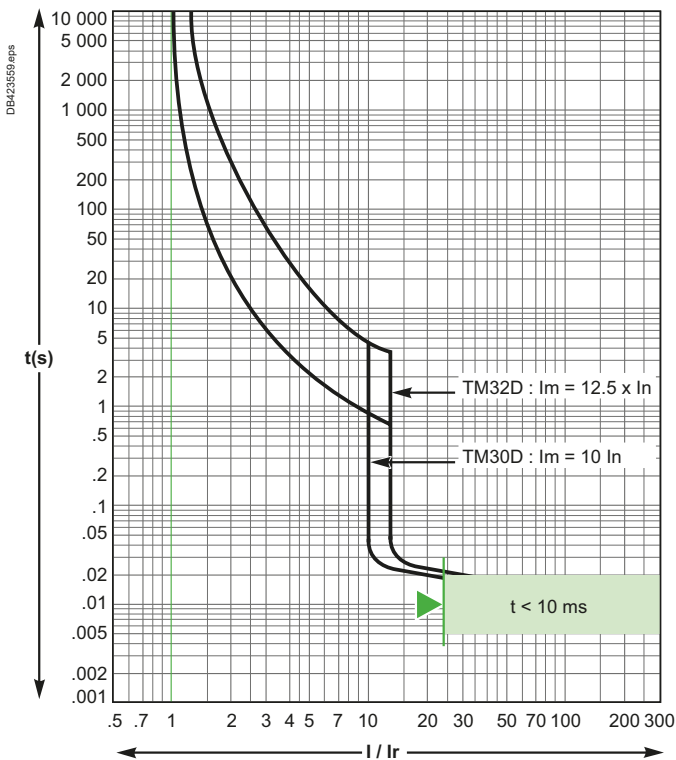

TM40D

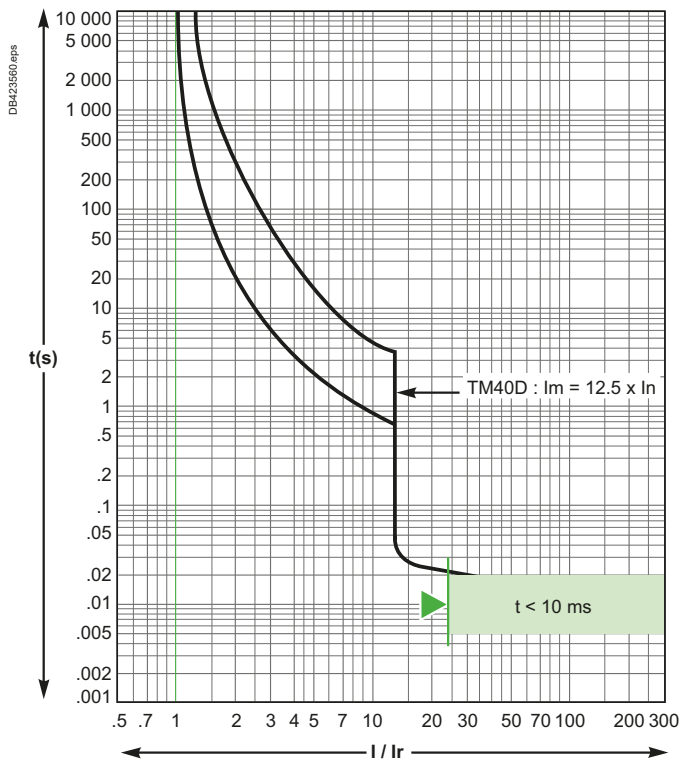

Reflex tripping.



# ComPact NSX100 to 250

## TMD magnetic trip units, tripping curves

### Protection of distribution systems

TM50D

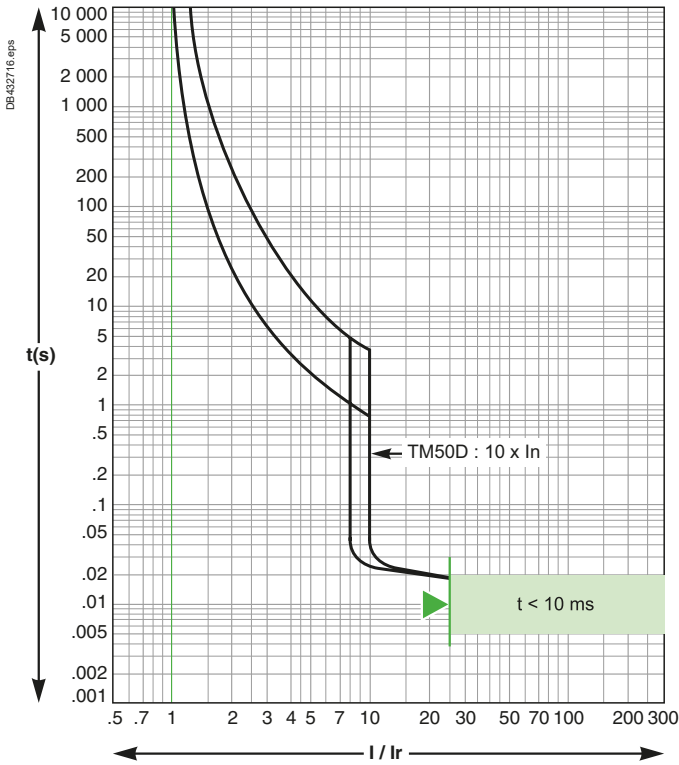

TM63D

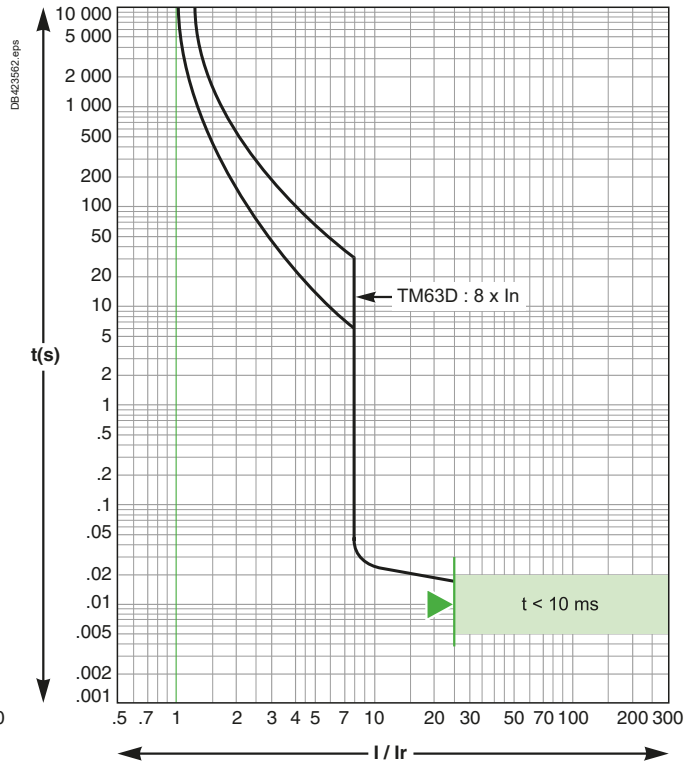

TM80D / TM100D

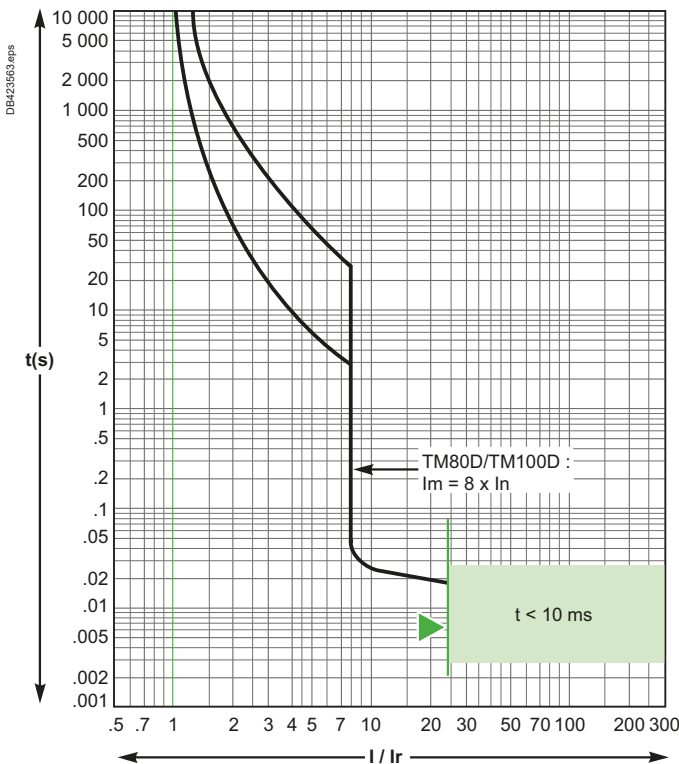

TM125D / TM160D

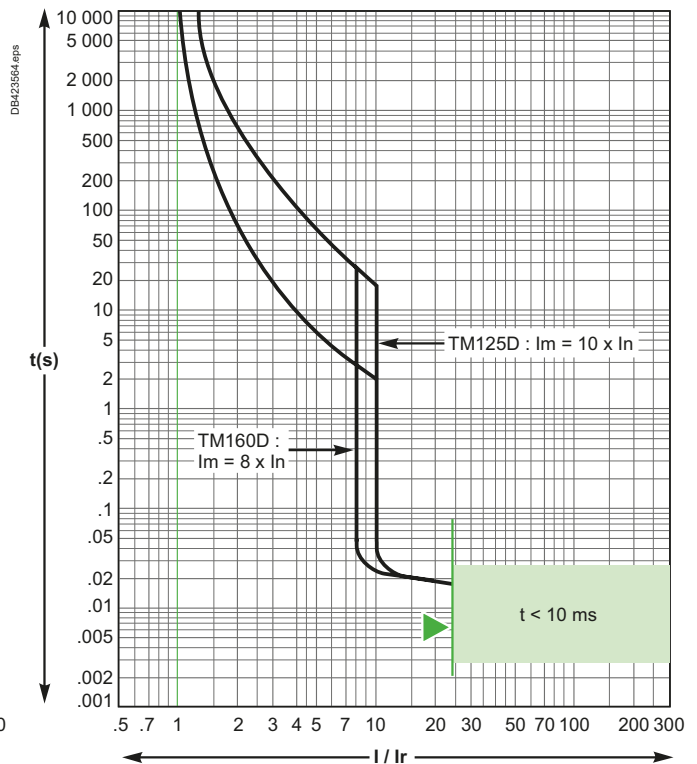

Reflex tripping.

# Additional characteristics

## ComPact NSX100 to 250

### TMD magnetic trip units, tripping curves

#### Protection of distribution systems

#### TM200D / TM250D

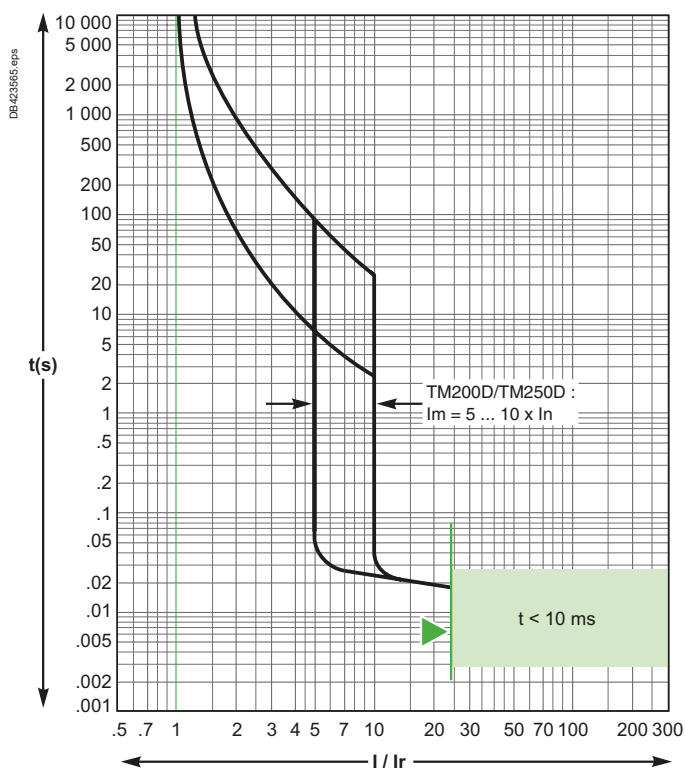

Reflex tripping.

**For all TDM curves :**

Values are given for 40 °C ambient,  $I_r = 1 \times I_n$ , 3 poles loaded, cold start.

For  $I_r = k \times I_n$ , read the time corresponding to  $1/k$  times given current.

For 1 pole tripping, read the time corresponding to 0.85 times given current.

For hot start ( $0.9 \times I_r$ ), divide max. time by 2, min. time by 4.



# ComPact NSX100 to 250

## TMG magnetic trip units, tripping curves

### Protection of distribution systems

TM16G

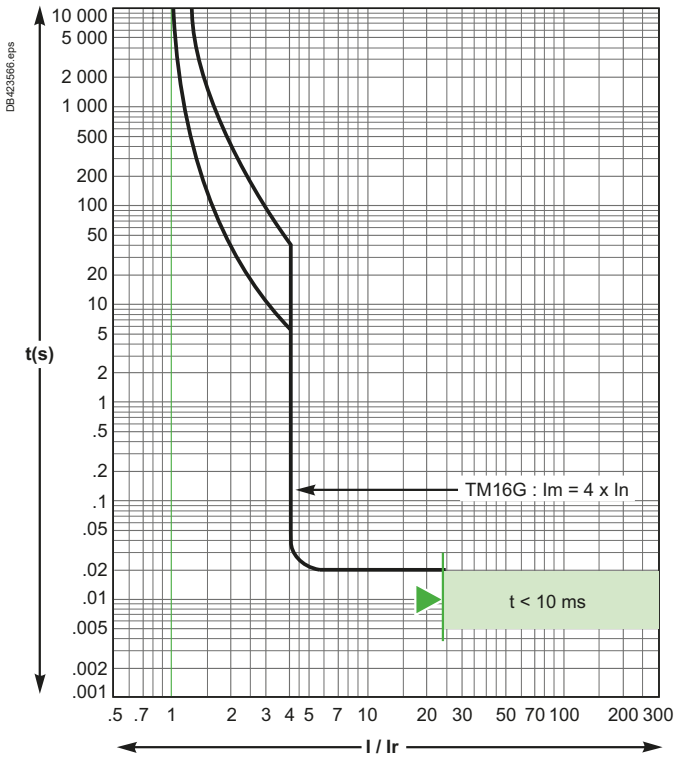

TM25G

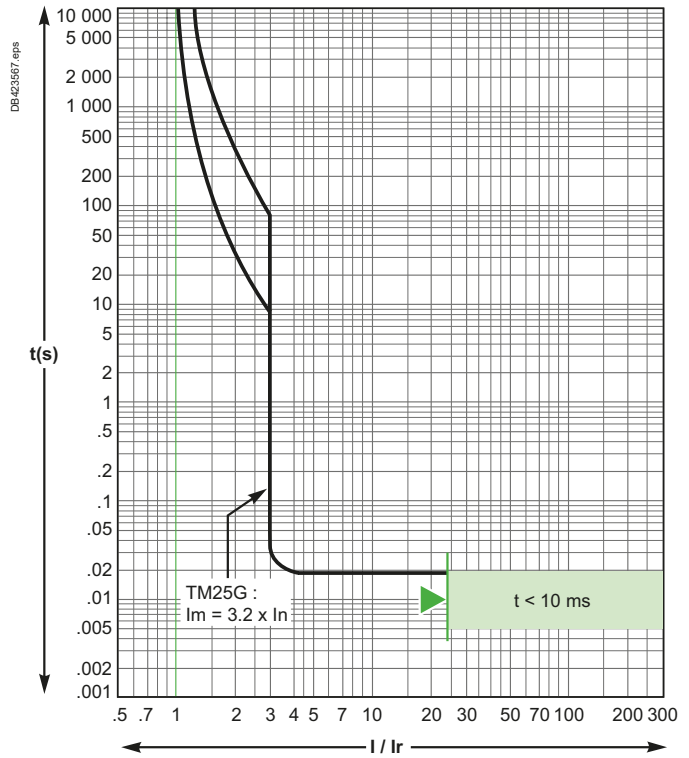

Reflex tripping.

TM40G

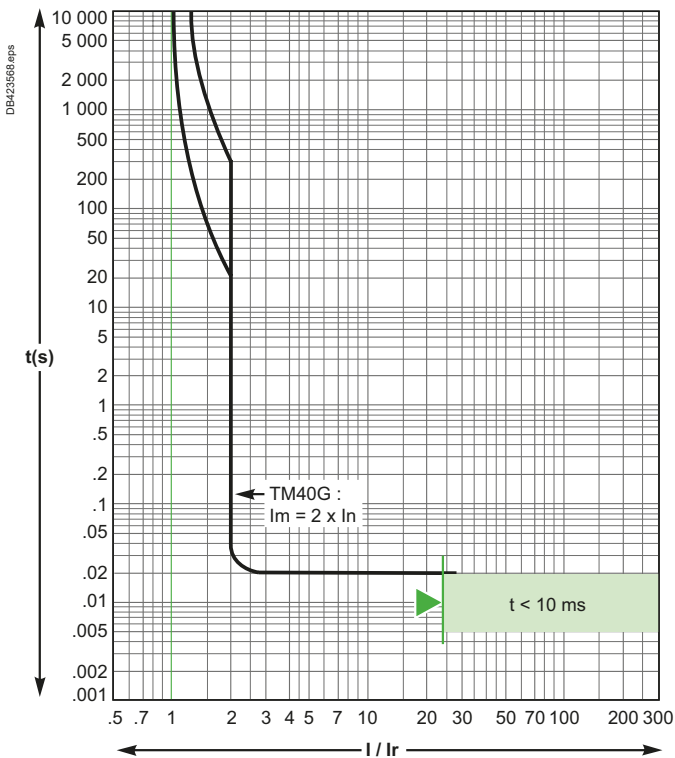

TM63G

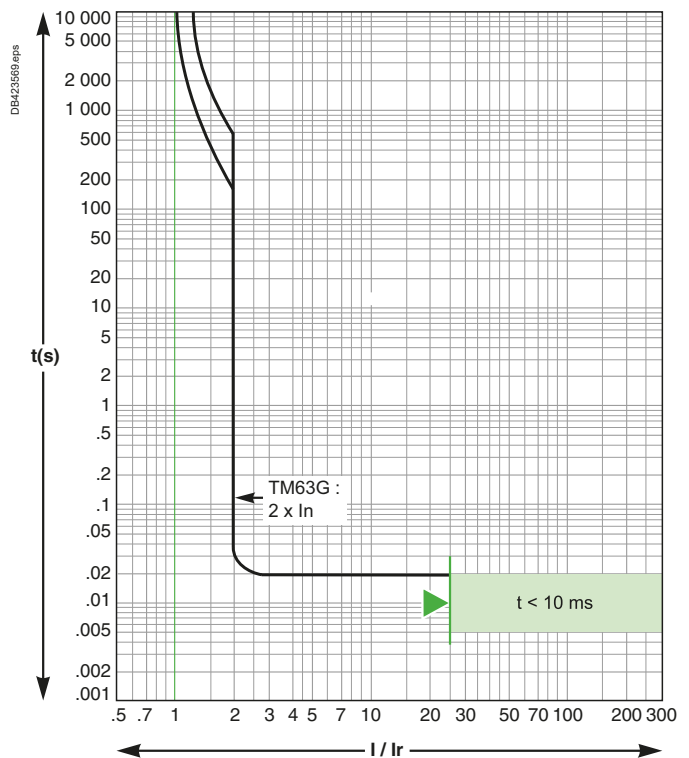

Reflex tripping.



# ComPact NSX100 to 250

## TMG magnetic trip units, tripping curves

### Protection of distribution systems

TM80G

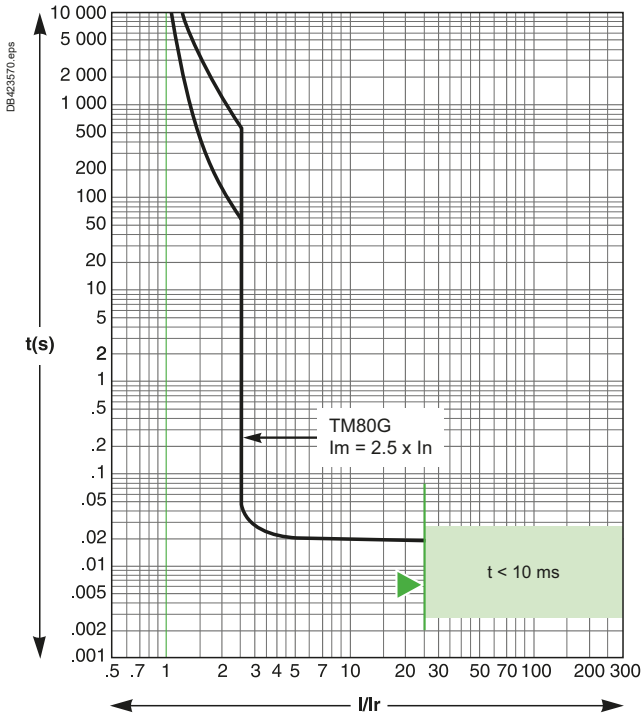

TM100G

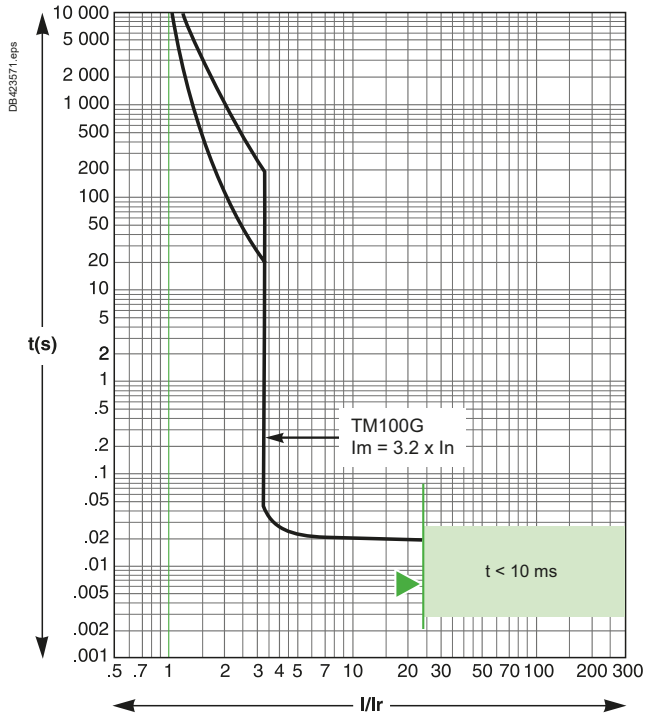

TM125G

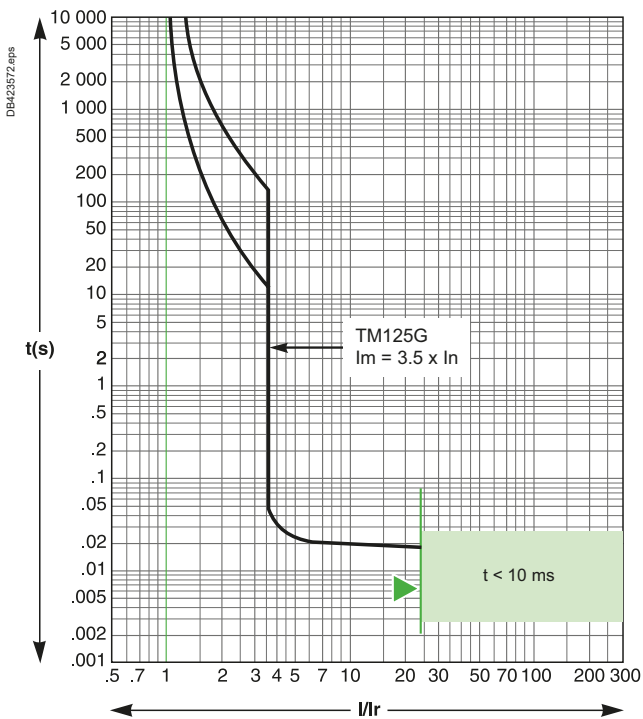

TM160G

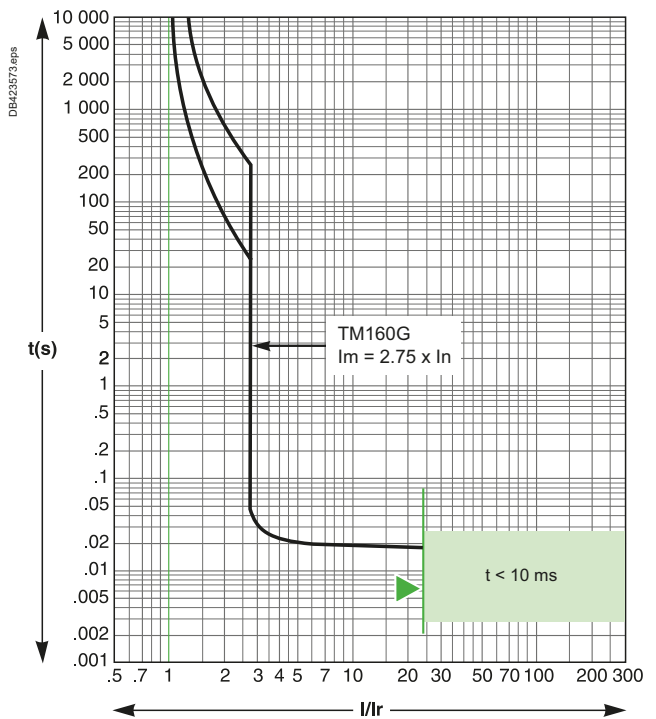

# ComPact NSX100 to 250

TMG magnetic trip units, tripping curves

Protection of distribution systems

TM200G

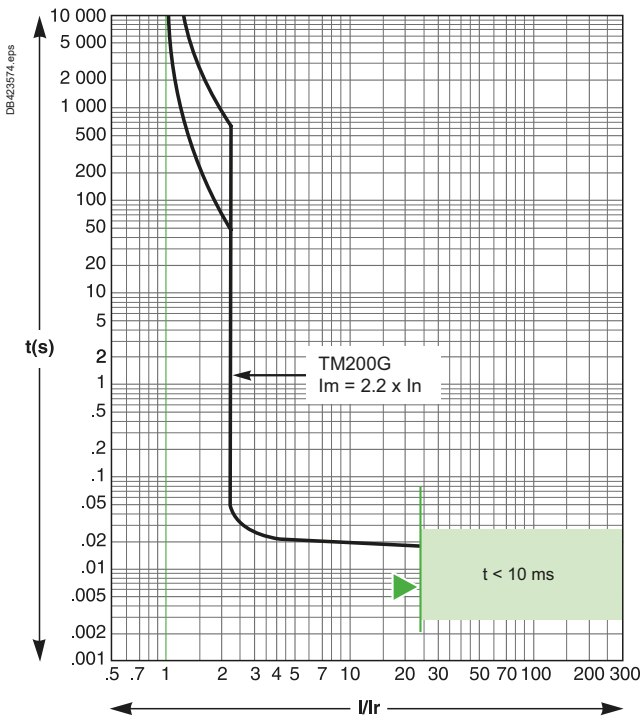

TM250G

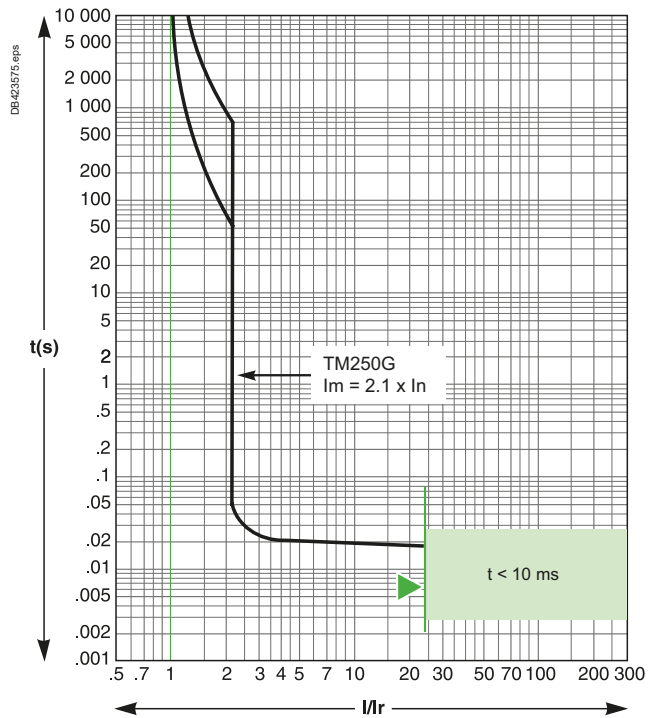

Reflex tripping.





# ComPact NSX100 to 250

## MicroLogic 2.2, 4.2 and 2.2 G electronic trip units, tripping curves Protection of distribution systems

MicroLogic 2.2, 4.2 - 40... 160 A

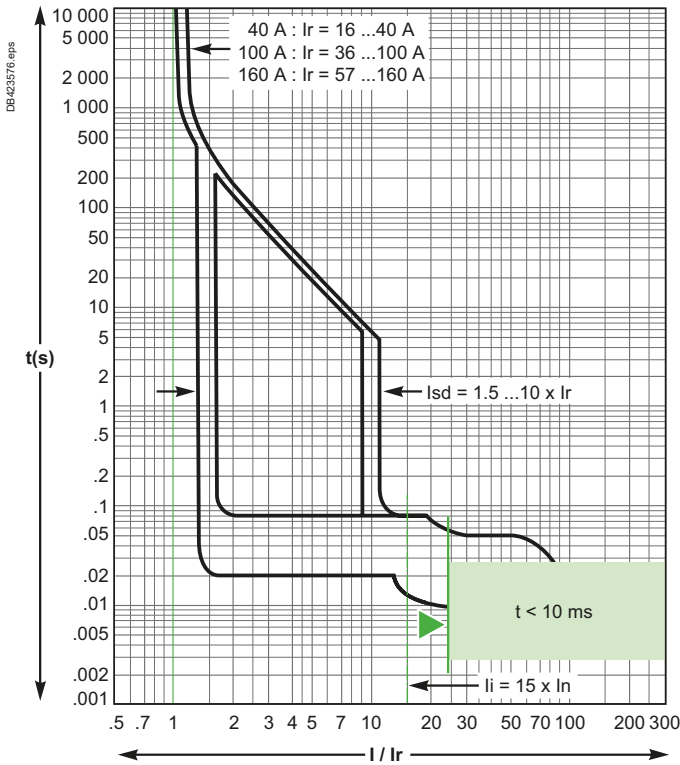

Reflex tripping.

MicroLogic 2.2, 4.2 - 250 A

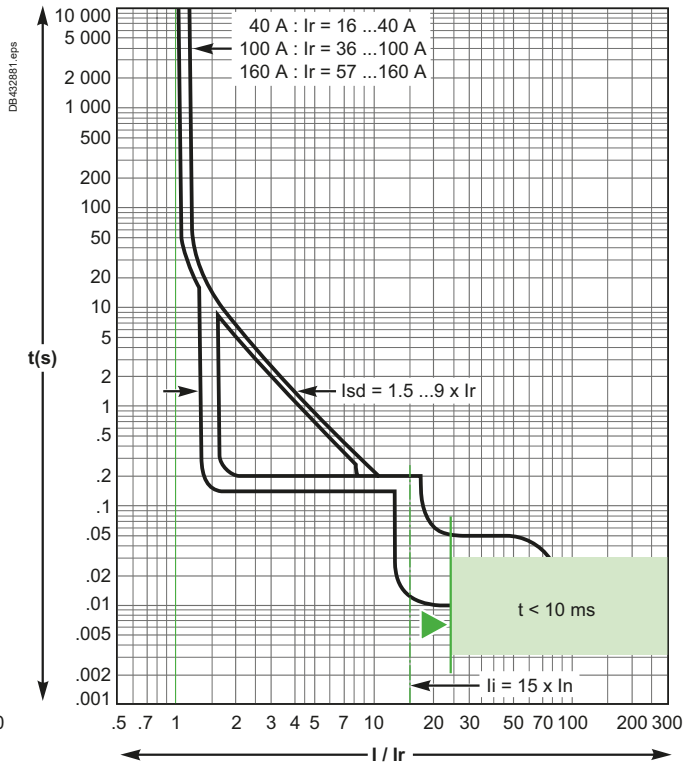

MicroLogic 2.2 G - 40... 160 A

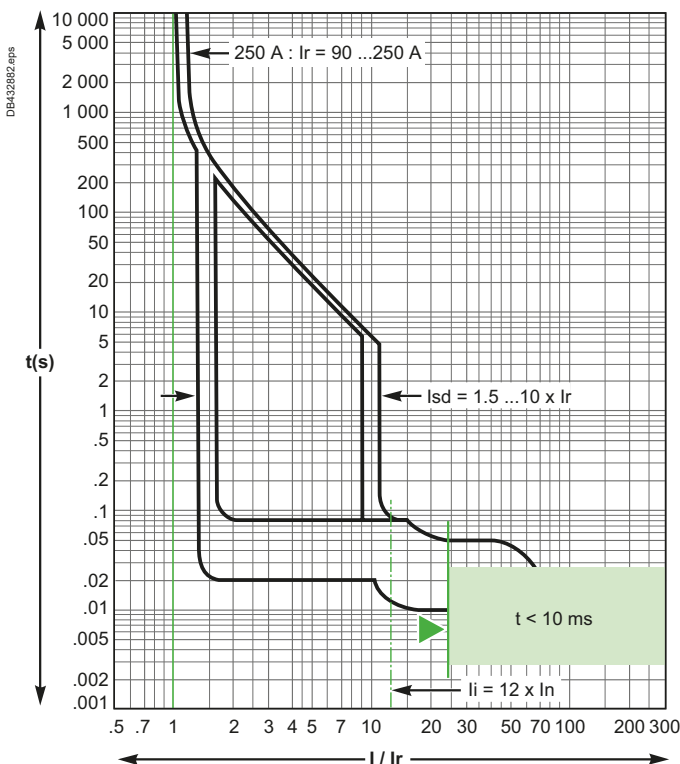

Reflex tripping.

MicroLogic 2.2 G - 250 A

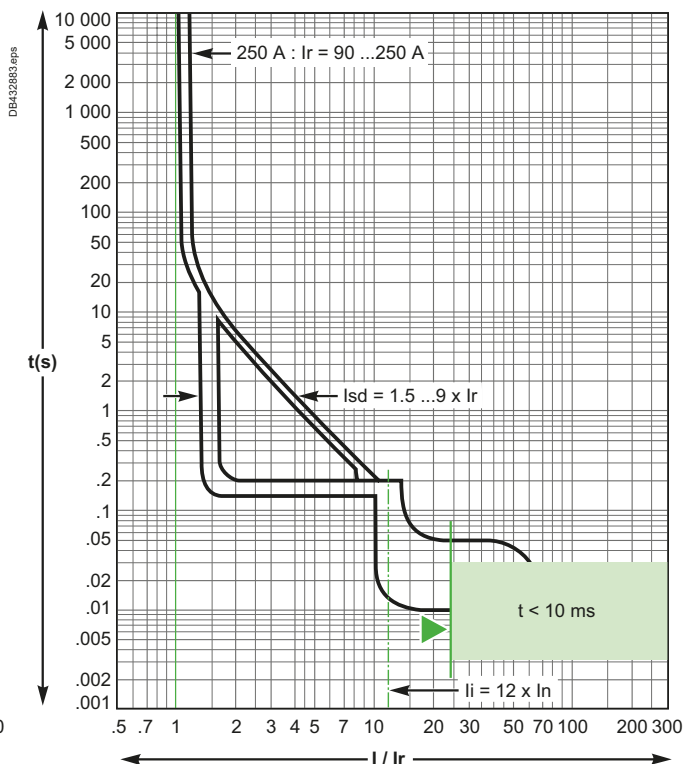

# ComPact NSX100 to 250

MicroLogic 5.2 and 6.2 A or E and 7.2 E electronic trip units, tripping curves - Protection of distribution systems

MicroLogic 5.2 and 6.2 A or E and 7.2 E - 40... 160 A

MicroLogic 5.2 and 6.2 A or E and 7.2 E - 250 A

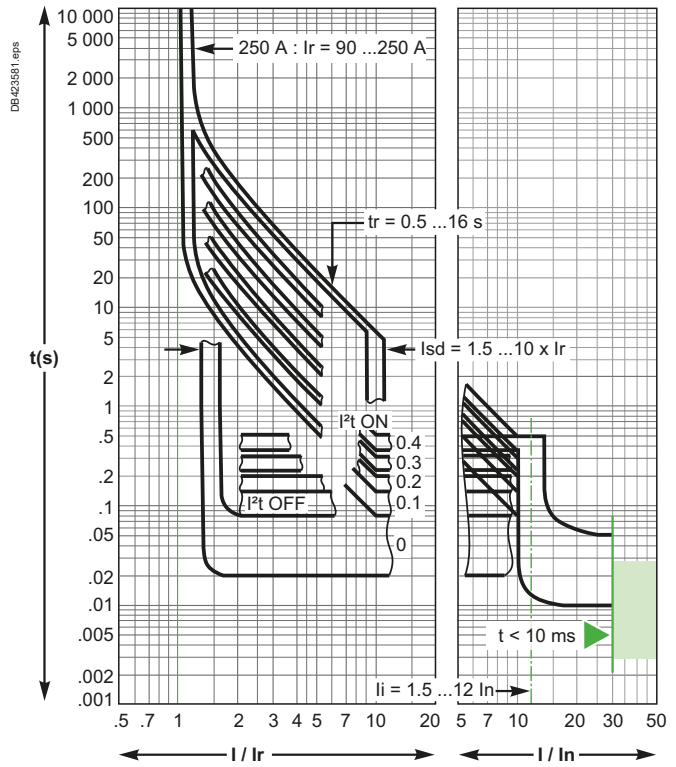
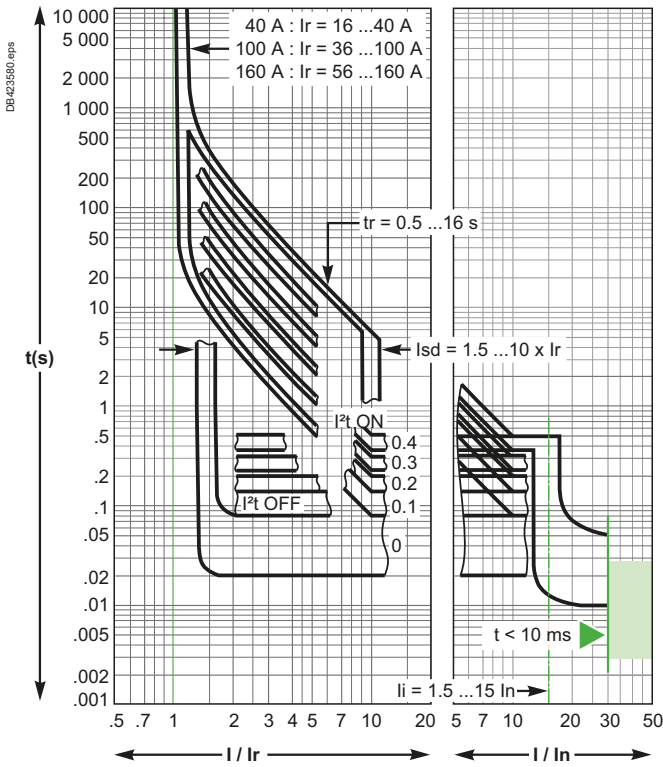

Reflex tripping.

MicroLogic 6.2 A or E (ground-fault protection)

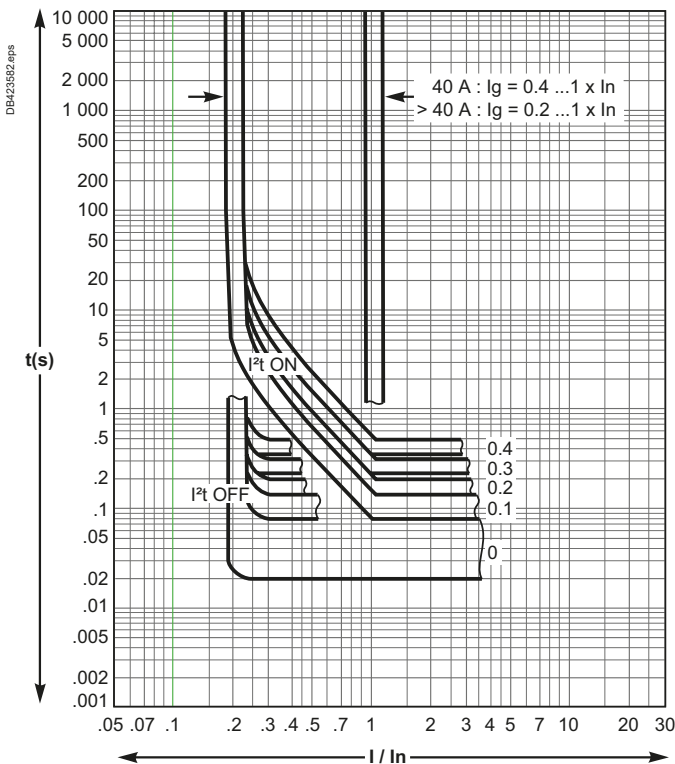

Reflex tripping.



# ComPact NSX100 to 250

## MA magnetic trip units, MicroLogic 2.2 M electronic trip units, tripping curves - Motor protection

MA2.5... MA100

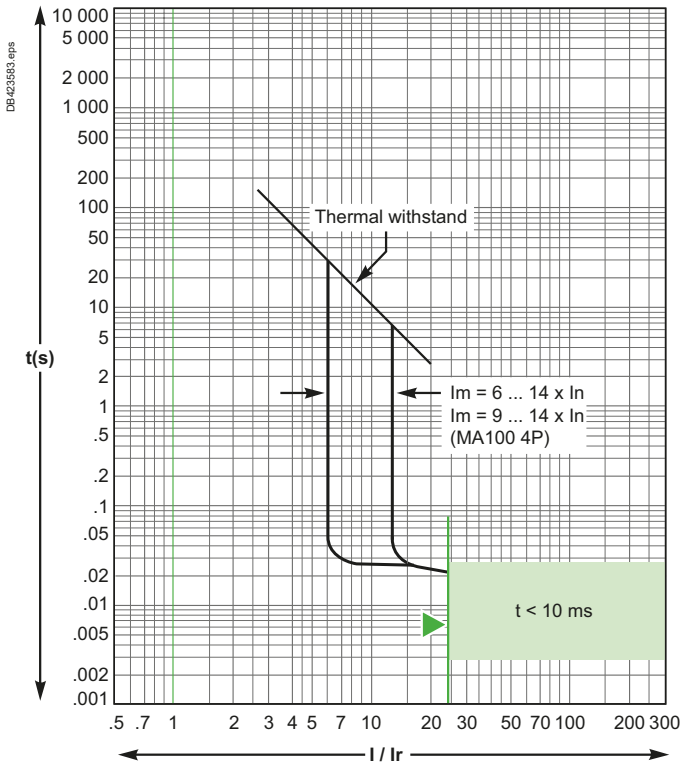

MA150 and MA220

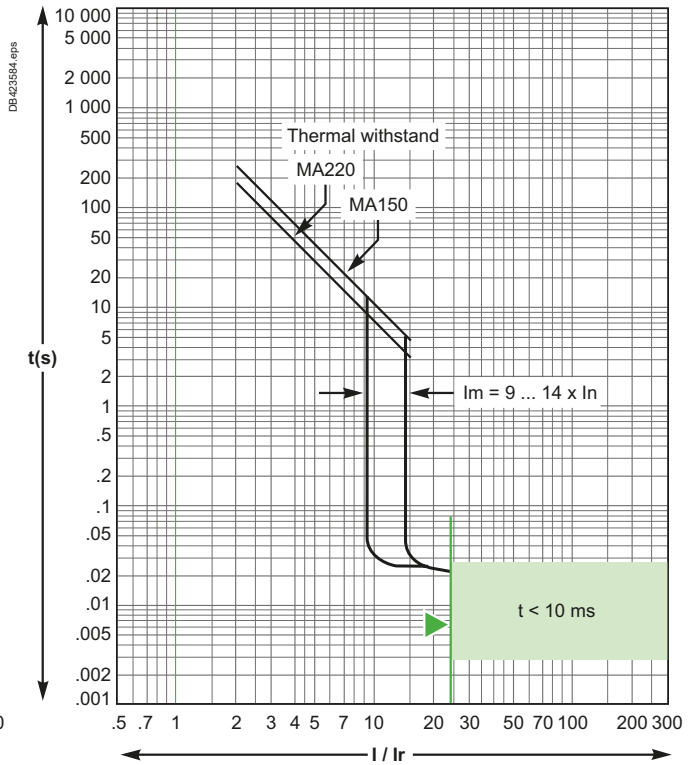

Reflex tripping.

MicroLogic 2.2 M - 25 A

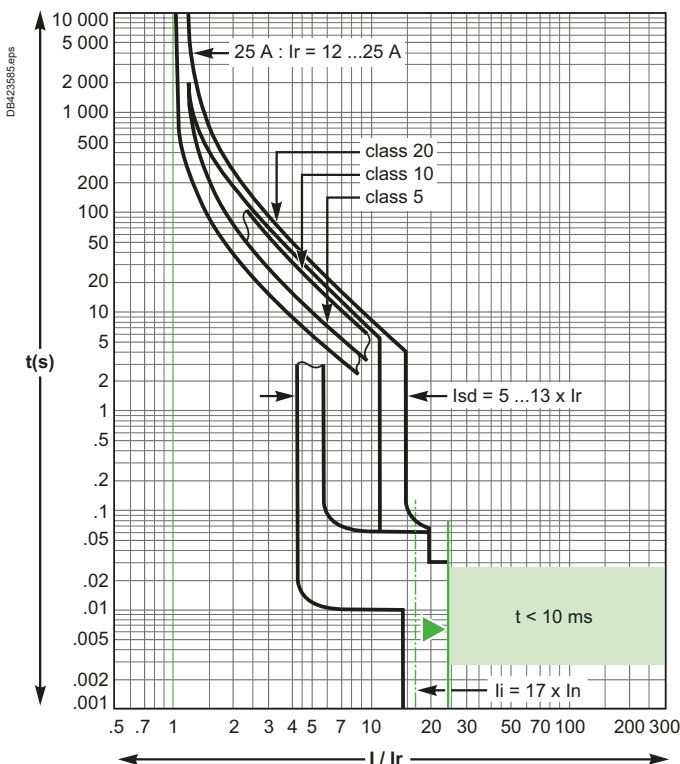

MicroLogic 2.2 M - 50... 220 A

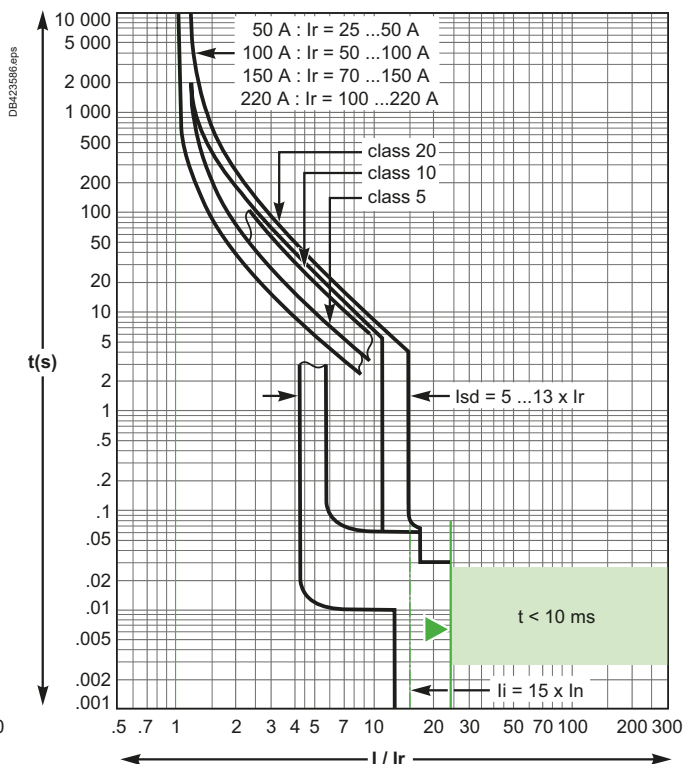

Reflex tripping.



# ComPact NSX100 to 250

## MicroLogic 6.2 E-M electronic trip units, tripping curves

### Motor protection

MicroLogic 6.2 E-M - 25 A

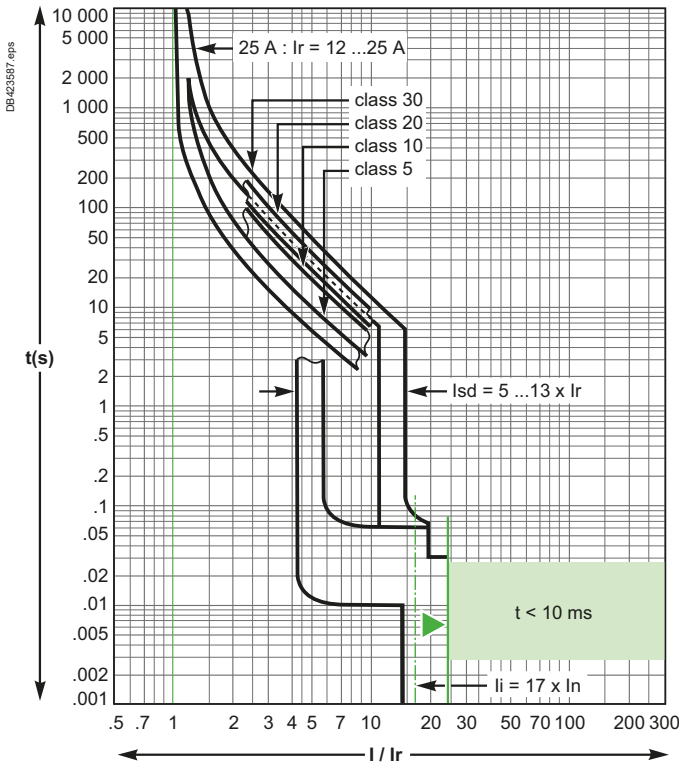

MicroLogic 6.2 E-M - 50... 220 A

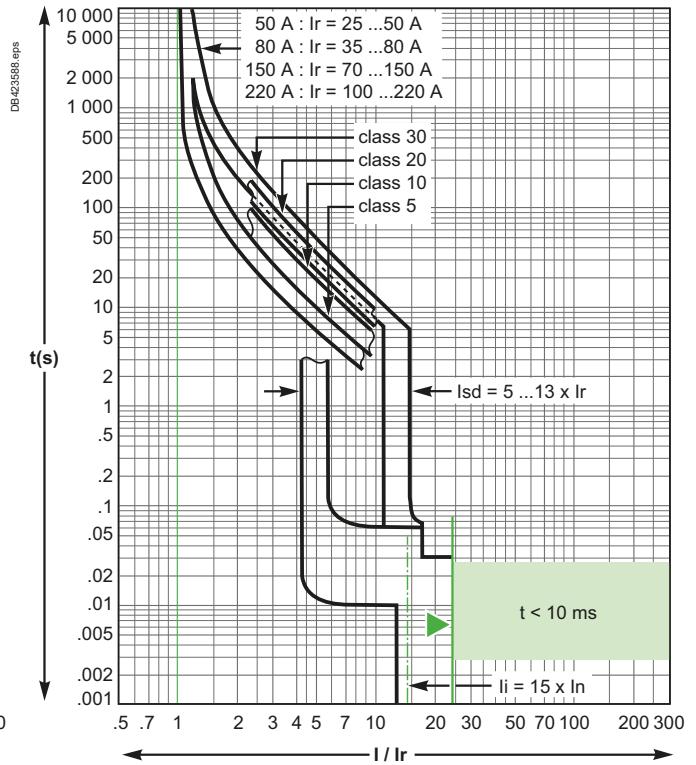

Reflex tripping.

MicroLogic 6.2 E-M (ground-fault protection)

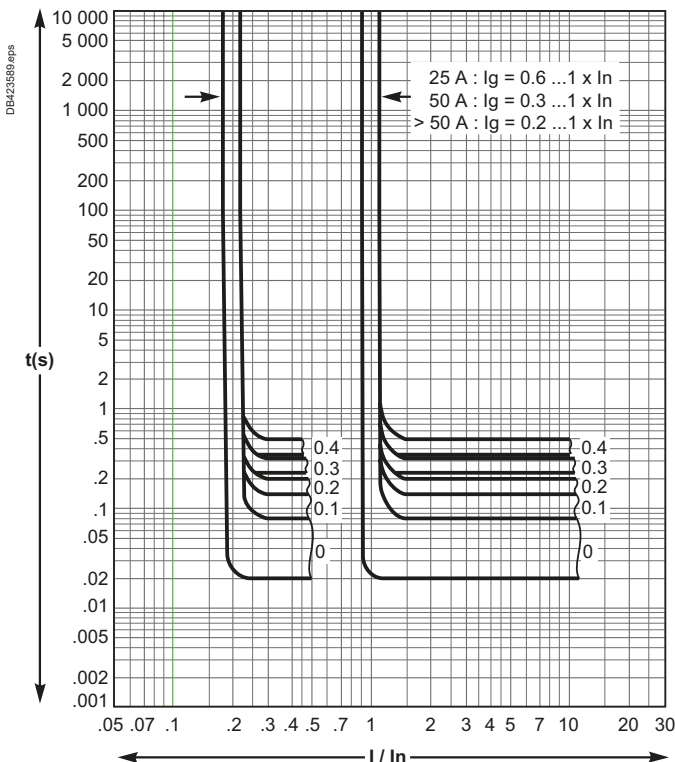

# ComPact NSX400 to 630

MicroLogic 2.3, 4.3, 5.3 and 6.3 A or E and 7.3 E electronic trip units, tripping curves - Protection of distribution systems

MicroLogic 2.3, 4.3 - 250... 400 A

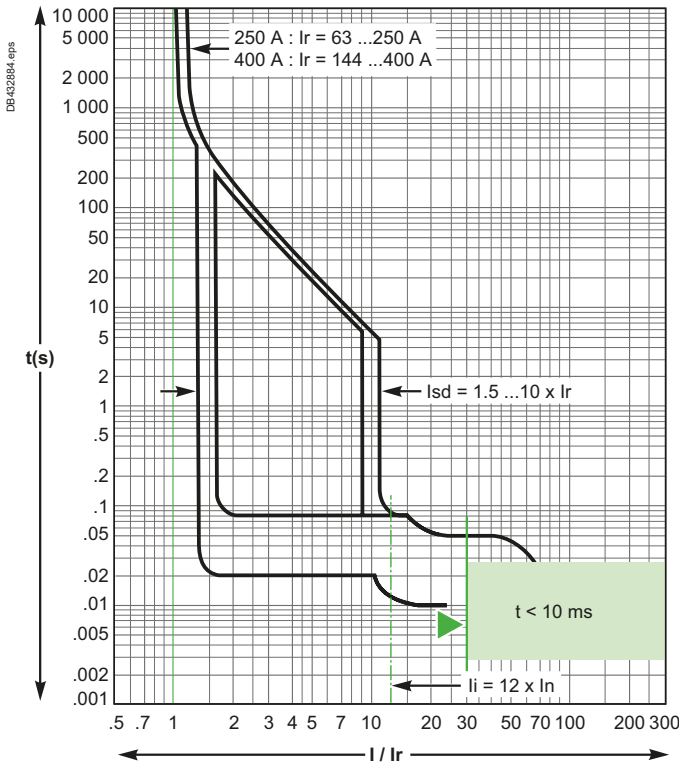

MicroLogic 2.3, 4.3 - 630 A

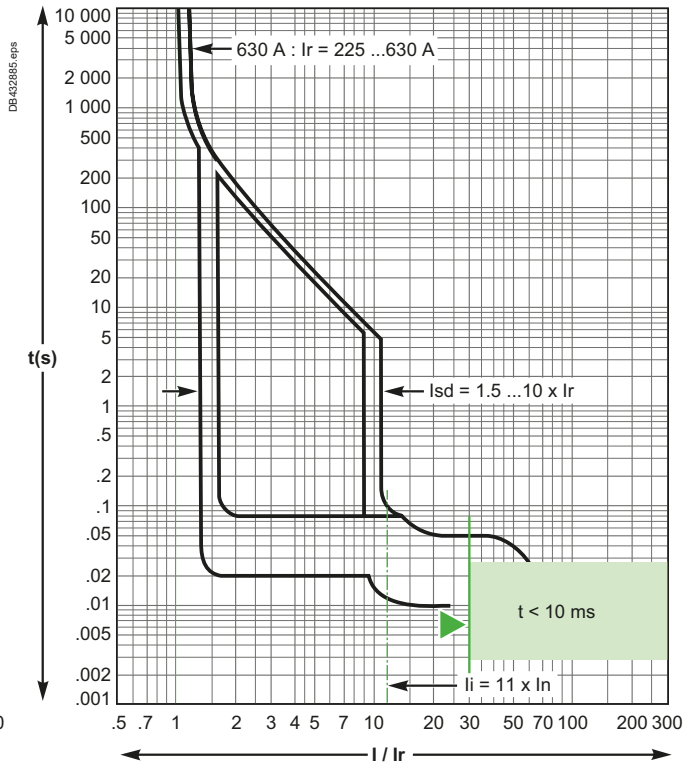

Reflex tripping.

MicroLogic 5.3 and 6.3 A or E and 7.3 E - 400 A

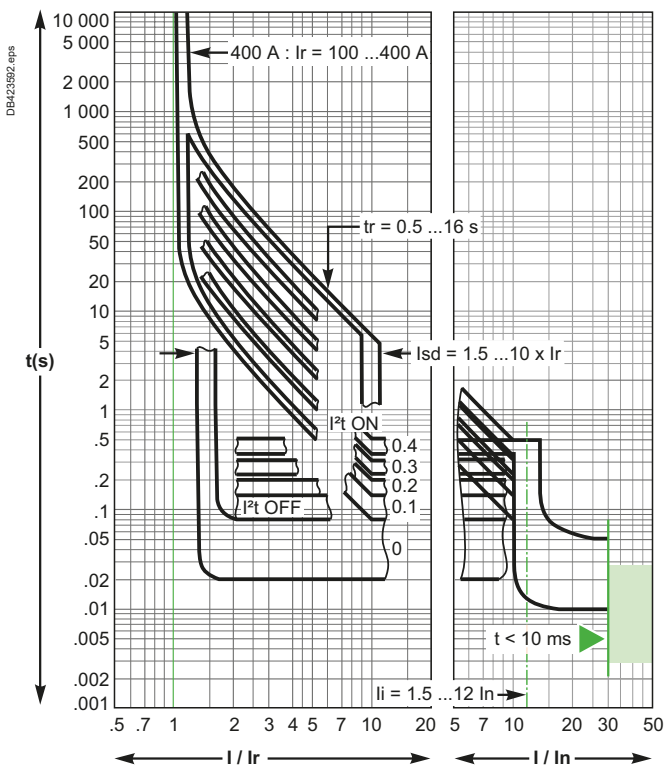

MicroLogic 5.3 and 6.3 A or E and 7.3E (up to 570 A) - 630 A

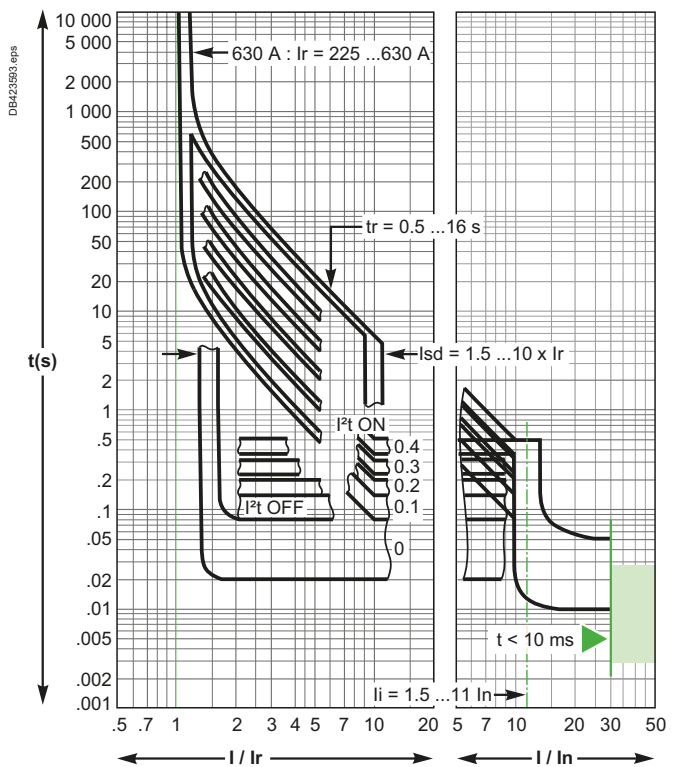

Reflex tripping.



### Additional characteristics

## ComPact NSX400 to 630

MicroLogic 6.3 A or E and 7.3 E electronic trip units, tripping curves - Protection of distribution systems

MicroLogic 6.3 A or E and 7.3 E (up to 570 A)  
(ground-fault protection)

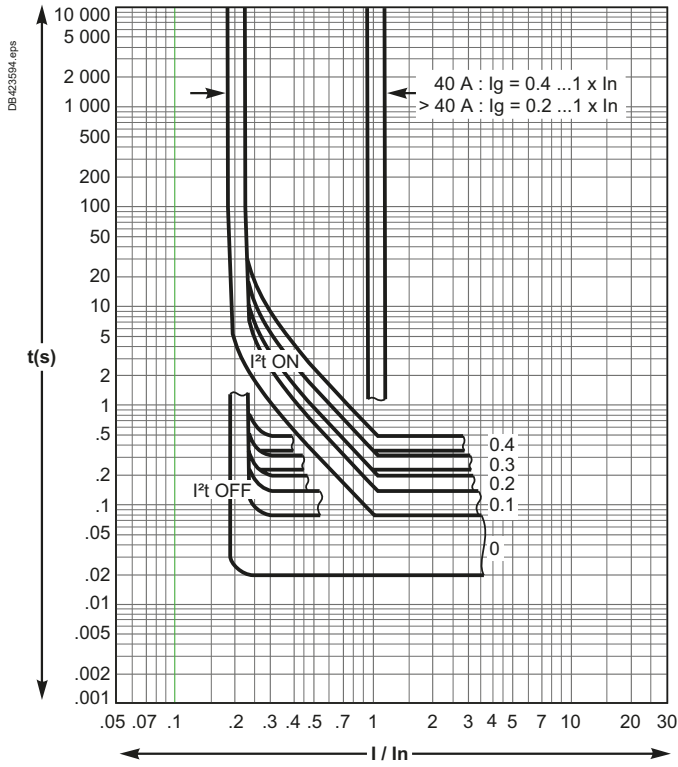

# ComPact NSX400 to 630

## MicroLogic 1.3 M and 2.3 M electronic trip units, tripping curves

### Motor protection

MicroLogic 1.3 M - 320 A

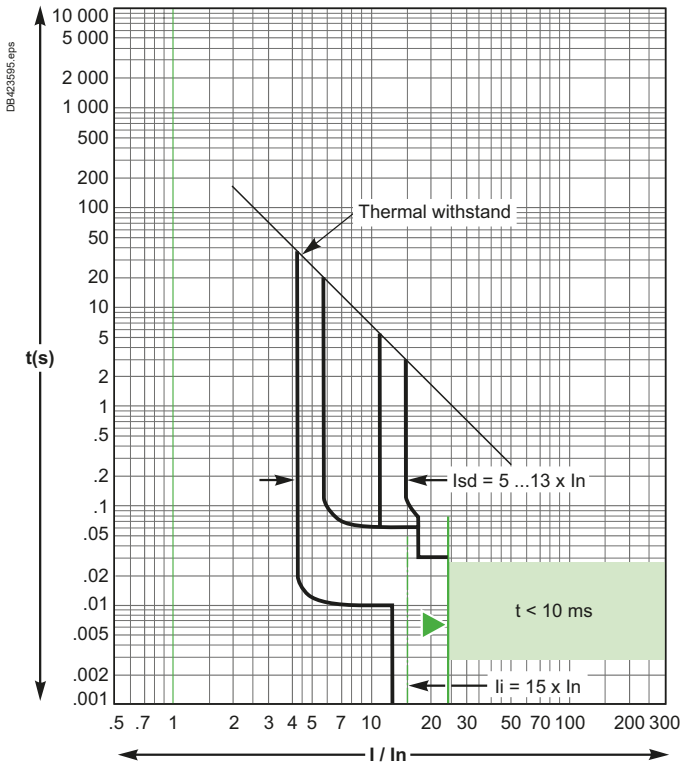

Reflex tripping.

MicroLogic 1.3 M - 500 A

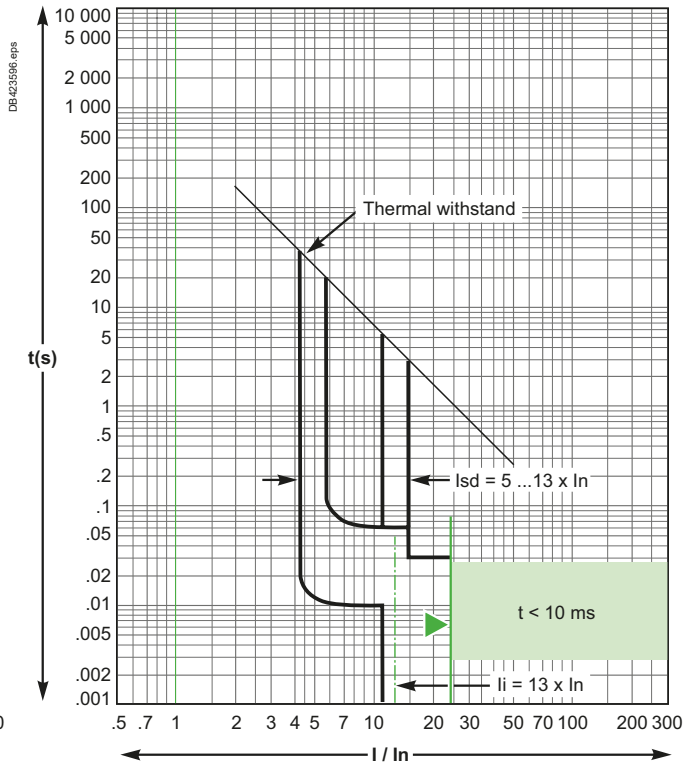

MicroLogic 2.3 M - 320 A

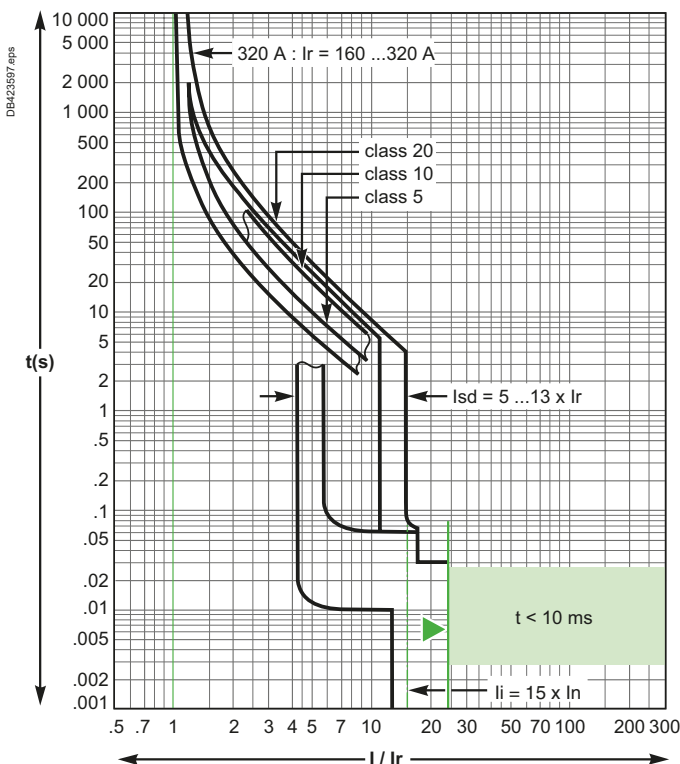

Reflex tripping.

MicroLogic 2.3 M - 500 A

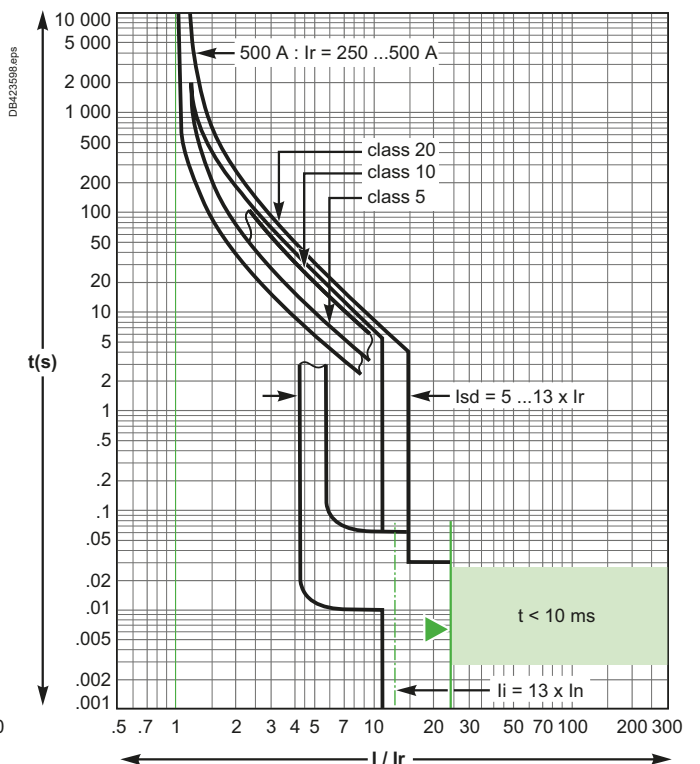

# ComPact NSX400 to 630

## MicroLogic 6.3 E-M electronic trip units, tripping curves

### Motor protection

MicroLogic 6.3 E-M - 320 A

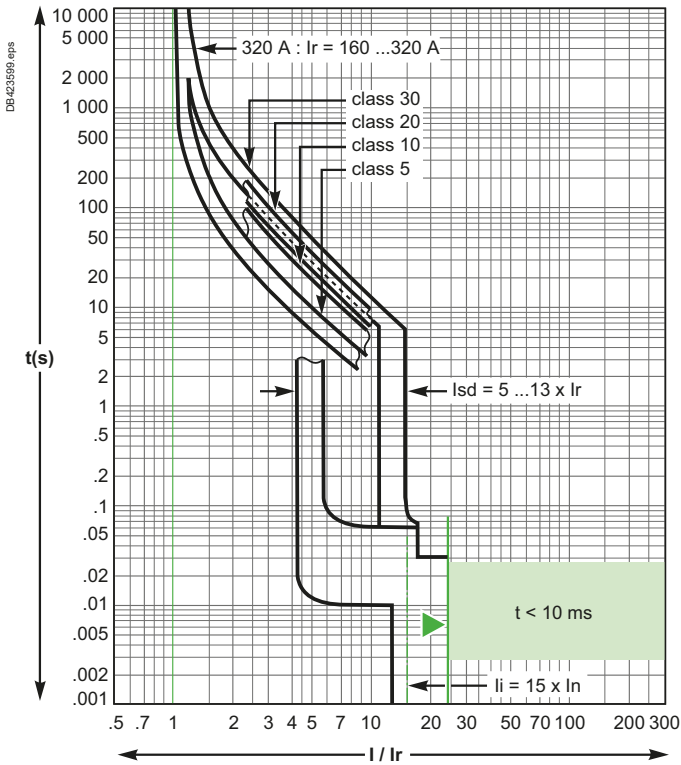

MicroLogic 6.3 E-M - 500 A

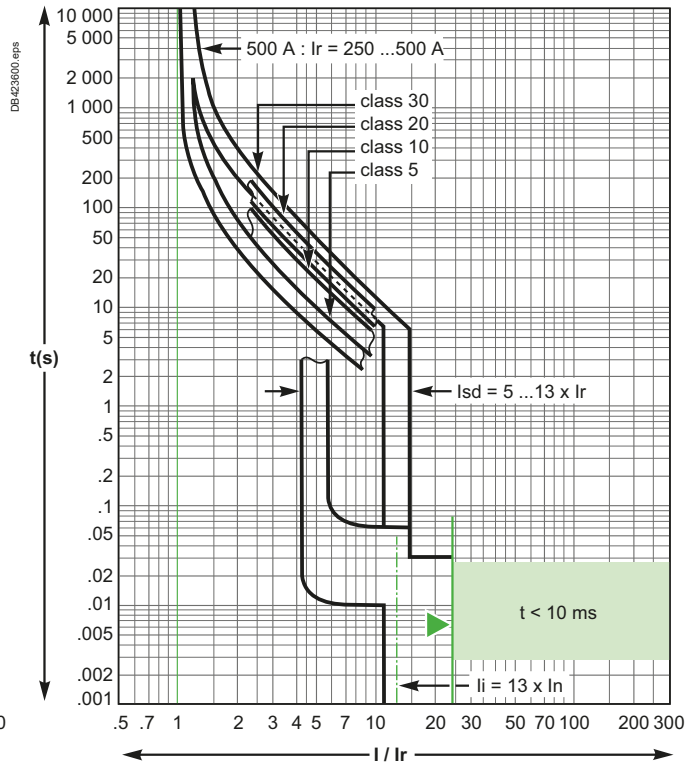

Reflex tripping.

MicroLogic 6.3 E-M (ground fault protection)

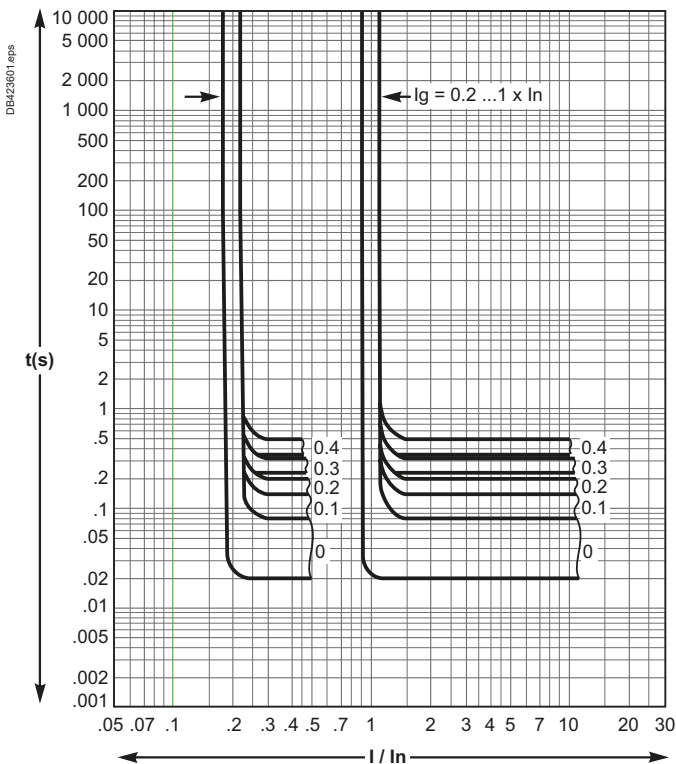



# Tripping curves ComPact NSXm and NSX

## Reflex tripping

ComPact NSXm and NSX100 to 630 devices incorporate the exclusive reflex-tripping system. This system breaks very high fault currents. The device is mechanically tripped via a "piston" actuated directly by the pressure produced in the breaking units by the short-circuit. For high short-circuits, this system provides a faster break, thereby ensuring selectivity. Reflex-tripping curves are exclusively a function of the circuit-breaker rating.

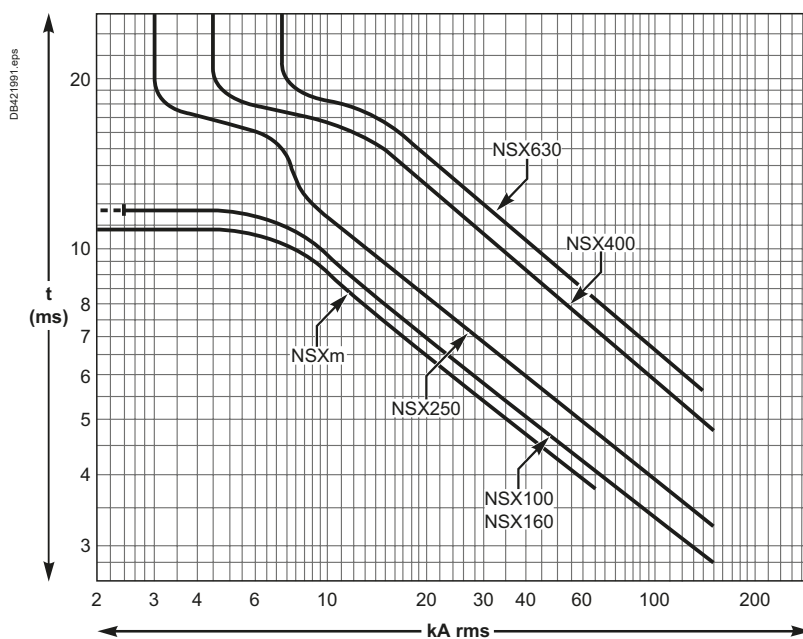

# Current and energy limiting curves

The limiting capacity of a circuit breaker is its aptitude to let through a current, during a short-circuit, that is less than the prospective short-circuit current.

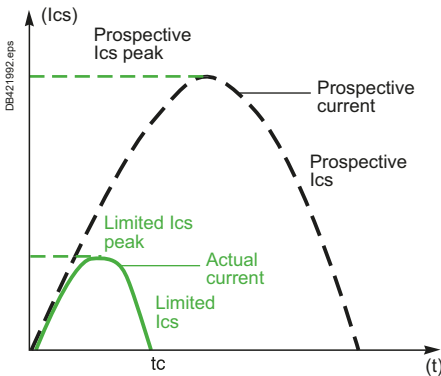

The exceptional limiting capacity of the ComPact range is due to the rotating double-break technique (very rapid natural repulsion of contacts and the appearance of two arc voltages in-series with a very steep wave front).

### Ics = 100 % Icu

The exceptional limiting capacity of the ComPact NSX and NSXm ranges greatly reduces the forces created by fault currents in devices. The result is a major increase in breaking performance. In particular, the service breaking capacity Ics is equal to 100 % of Icu. The Ics value, defined by IEC standard 60947-2, is guaranteed by tests comprising the following steps:

- break three times consecutively a fault current equal to 100 % of Icu
- check that the device continues to function normally, that is:
  - it conducts the rated current without abnormal temperature rise
  - protection functions perform within the limits specified by the standard
  - suitability for isolation is not impaired.

### Longer service life of electrical installations

Current-limiting circuit breakers greatly reduce the negative effects of short-circuits on installations.

#### Thermal effects

Less temperature rise in conductors, therefore longer service life for cables.

#### Mechanical effects

Reduced electrodynamic forces, therefore less risk of electrical contacts or busbars being deformed or broken.

#### Electromagnetic effects

Fewer disturbances for measuring devices located near electrical circuits.

### Economy by means of cascading

Cascading is a technique directly derived from current limiting. Circuit breakers with breaking capacities less than the prospective short-circuit current may be installed downstream of a limiting circuit breaker. The breaking capacity is reinforced by the limiting capacity of the upstream device. It follows that substantial savings can be made on downstream equipment and enclosures.

### Current and energy limiting curves

The limiting capacity of a circuit breaker is expressed by two curves which are a function of the prospective short-circuit current (the current which would flow if no protection devices were installed):

- the actual peak current (limited current)
- thermal stress (A<sup>2</sup>s), i.e. the energy dissipated by the short-circuit in a conductor with a resistance of 1 Ω.

#### Example

What is the real value of a 70 kA rms prospective short-circuit (i.e. 100 kA peak) limited by an NSXm160H upstream ?

The answer is 20 kA peak.

### Maximum permissible cable stresses

The table below indicates the maximum permissible thermal stresses for cables depending on their insulation, conductor (Cu or Al) and their cross-sectional area (CSA). CSA values are given in mm<sup>2</sup> and thermal stresses in A<sup>2</sup>s.

CSA		1.5 mm <sup>2</sup>	2.5 mm <sup>2</sup>	4 mm <sup>2</sup>	6 mm <sup>2</sup>	10 mm <sup>2</sup>
PVC	Cu	2.97x10 <sup>4</sup>	8.26x10 <sup>4</sup>	2.12x10 <sup>5</sup>	4.76x10 <sup>5</sup>	1.32x10 <sup>6</sup>
	Al					5.41x10 <sup>5</sup>
PRC	Cu	4.10x10 <sup>4</sup>	1.39x10 <sup>5</sup>	2.92x10 <sup>5</sup>	6.56x10 <sup>5</sup>	1.82x10 <sup>6</sup>
	Al					7.52x10 <sup>5</sup>
CSA		16 mm <sup>2</sup>	25 mm <sup>2</sup>	35 mm <sup>2</sup>	50 mm <sup>2</sup>	
PVC	Cu	3.4x10 <sup>6</sup>	8.26x10 <sup>6</sup>	1.62x10 <sup>7</sup>	3.31x10 <sup>7</sup>	
	Al	1.39x10 <sup>6</sup>	3.38x10 <sup>6</sup>	6.64x10 <sup>6</sup>	1.35x10 <sup>7</sup>	
PRC	Cu	4.69x10 <sup>6</sup>	1.39x10 <sup>7</sup>	2.23x10 <sup>7</sup>	4.56x10 <sup>7</sup>	
	Al	1.93x10 <sup>6</sup>	4.70x10 <sup>6</sup>	9.23x10 <sup>6</sup>	1.88x10 <sup>7</sup>	

#### Example

Is a Cu/PVC cable with a CSA of 10 mm<sup>2</sup> adequately protected by an NSX160F?

The table above indicates that the permissible stress is 1.32x10<sup>6</sup> A<sup>2</sup>s.

All short-circuit currents at the point where an NSX160F (Icu = 35 kA) is installed are limited with a thermal stress less than 6x10<sup>5</sup> A<sup>2</sup>s.

Cable protection is therefore ensured up to the limit of the breaking capacity of the circuit breaker.



# Current and energy limiting curves ComPact NSXm

## Current-limiting curves

### Voltage 400/440 V AC

Limited short-circuit current (kA peak)

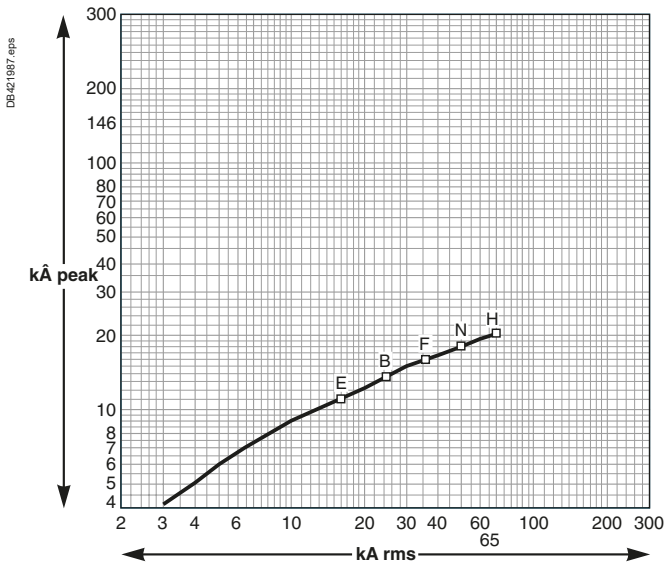

### Voltage 660/690 V AC

Limited short-circuit current (kA peak)

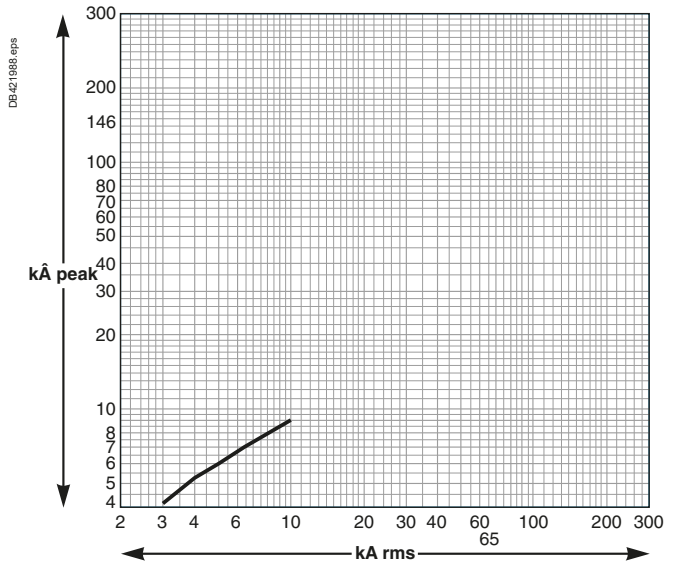

## Energy-limiting curves

### Voltage 400/440 V AC

Limited energy

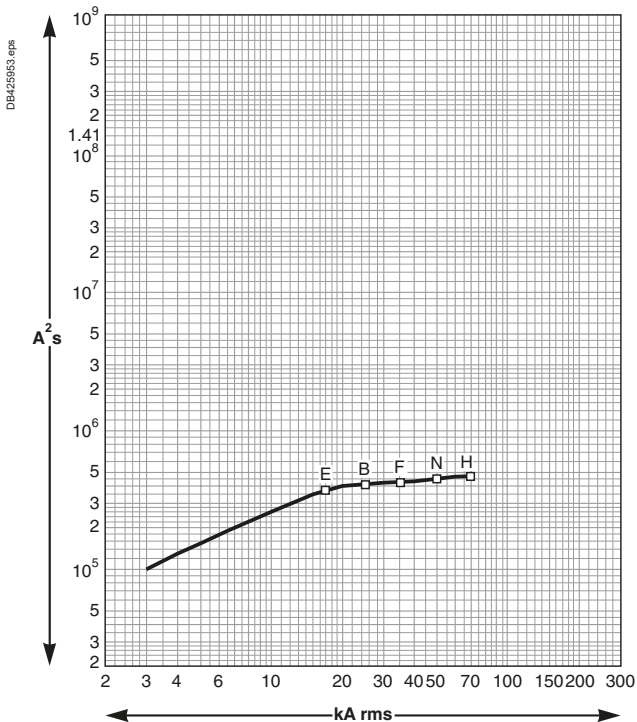

### Voltage 660/690 V AC

Limited energy

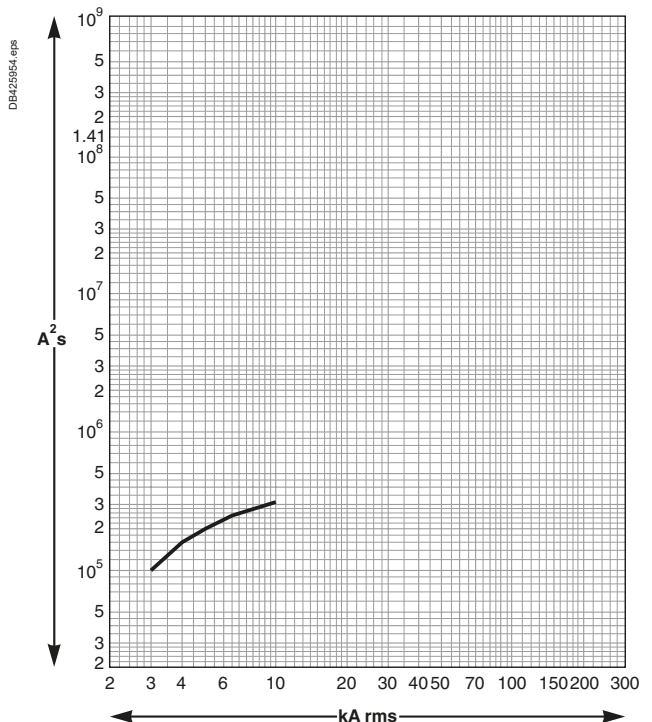

# Current and energy limiting curves

## ComPact NSX

### Current-limiting curves

#### Voltage 400/440 V AC

Limited short-circuit current (kA peak)

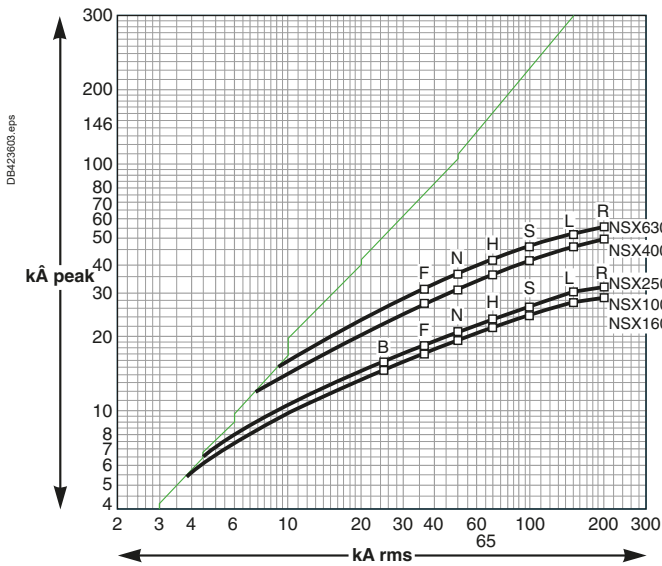

#### Voltage 660/690 V AC

Limited short-circuit current (kA peak)

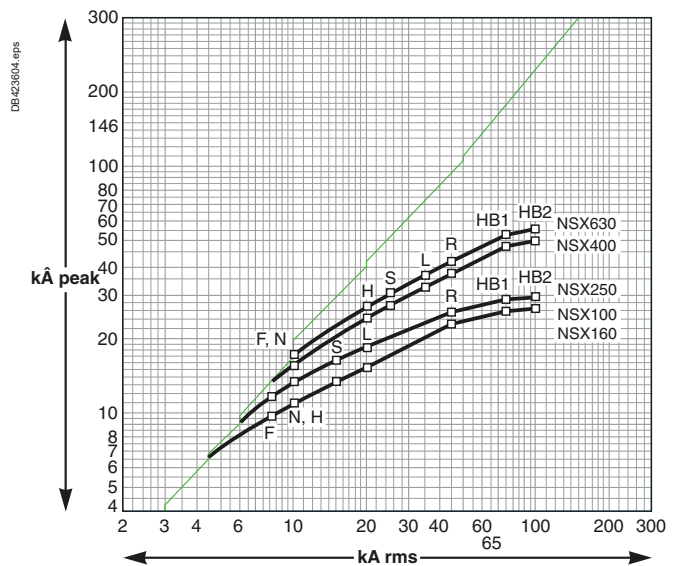

### Energy-limiting curves

#### Voltage 400/440 V AC

Limited energy

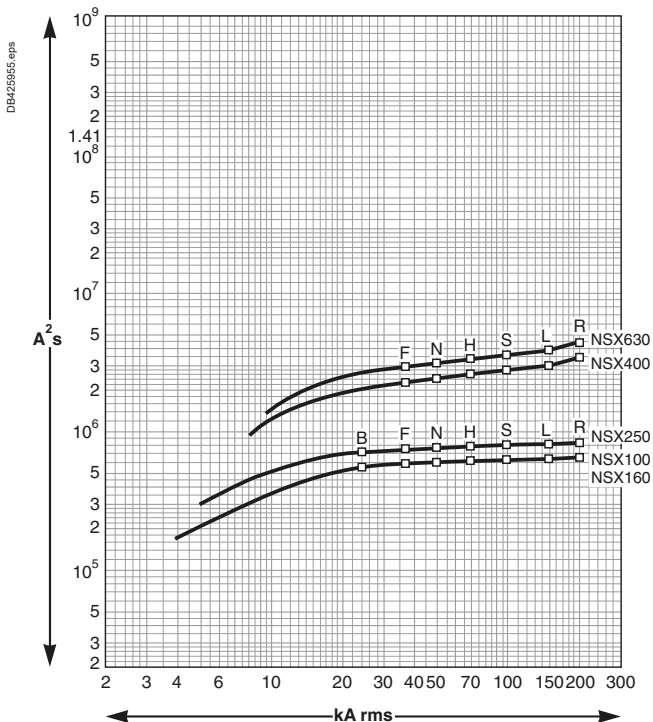

#### Voltage 660/690 V AC

Limited energy

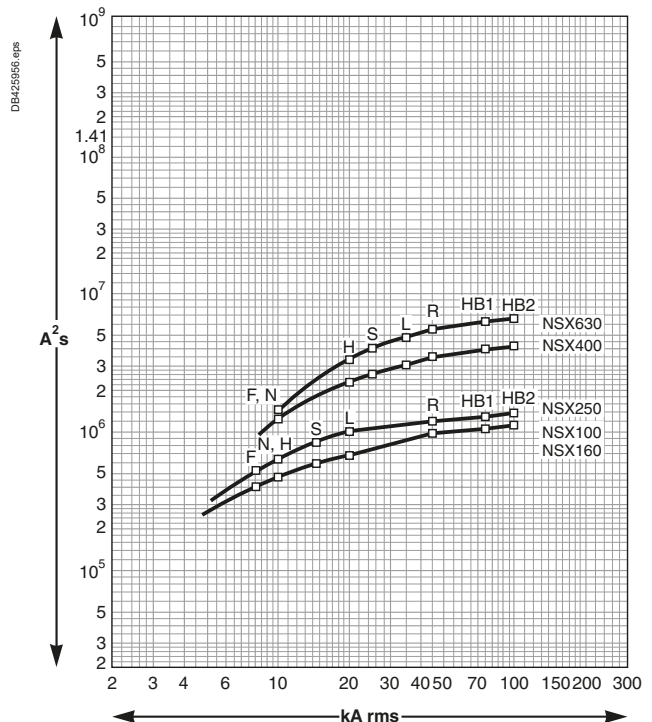

H



# Note

H



Life Is On



**Schneider Electric Industries SAS**

35, rue Joseph Monier  
CS 30323  
92506 Rueil Malmaison Cedex  
France

RCS Nanterre 954 503 439  
Capital social 928 298 512 €  
[www.se.com](http://www.se.com)

LVPED217032EN • WEB1 cat.2019

