

Datasheet

Worm Drive Stainless Steel Hose Clip

RS Stock No: 145-0266



Specification:

Material: AISI304 – All 304 Stainless Steel

Plating: None

Drawing:

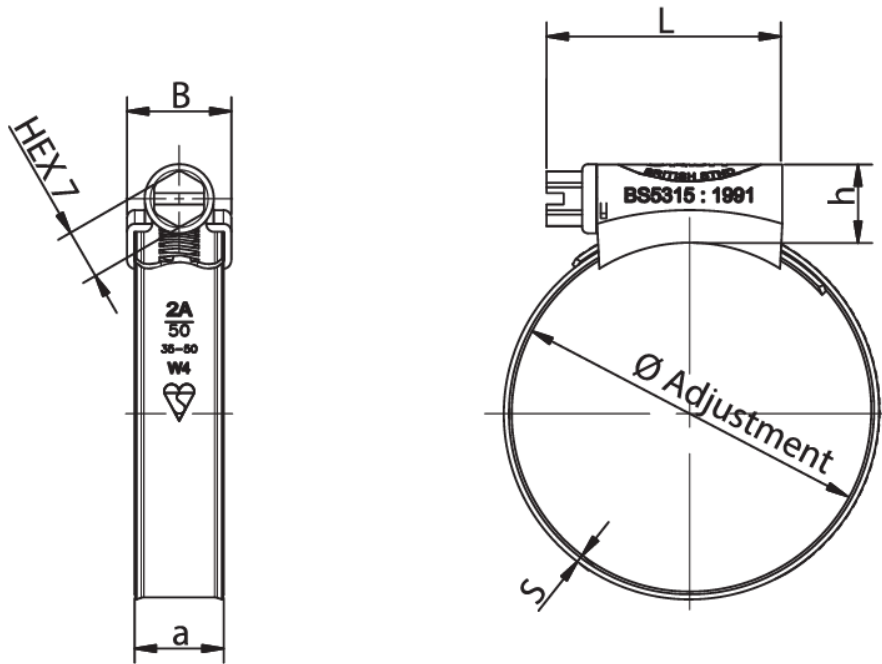

Stock no	BS Size	Range		L max	S±0.05	h max	a Band Width	b max	Torque Nm
		mm	in						
1450264	12	9.5 – 12	3/8 - 1/2	19.5	0.80	10.0	9.5	12.3	4.5
1450265	16	11 – 16	1/2 - 5/8						
1450266	20	13 – 20	1/2 - 3/4						
1450267	22	16 – 22	5/8 - 7/8	25.0		11.5	12.0	14.7	5.6
1450268	25	18 – 25	3/4 - 1						
1450269	30	22 – 30	7/8 - 1 1/8						
1450270	35	25 – 35	1 - 1 3/8						
1450271	40	30 – 40	1 1/8 - 1 5/8						
1450272	45	35 – 45	1 3/8 - 1 3/4						
1450273	50	35 – 50	1 3/8 - 2	33.0					9.0
1450274	55	40 – 55	1 5/8 - 2 1/8						
1450275	60	45 – 60	1 3/4 - 2 3/8						
1450277	70	55 – 70	2 - 2 3/4						
1450278	80	60 – 80	2 3/8 - 3 1/8						
1450279	90	70 – 90	2 3/4 - 3 1/2						
1450280	100	85 – 100	3 1/8 - 4						
1450281	120	90 – 120	3 1/2 - 4 3/4						
1450283	140	120 – 140	4 1/8 - 5						
1450284	150	130 – 150	5 - 5 3/4	7.9					
1450285	160	130 – 160	5 1/8 - 6 1/4						
1450286	180	150 – 180	5 7/8 - 7 1/8						



Product feature:

These hose clips are manufactured in 304 grade stainless steel. They are tested and “BSI Kitemark™” certified according to British Standard 5315:1991. OBBSW4 is made entirely from AISI-304 stainless steel, austenitic grade 18/8 Stainless Steel (18% Chromium with 8% Nickel), which is comparable to W4 DIN3017 (German Standard).

The hose clip is optimized for hose protection by raising the band edges and precisely stamping the band to provide a smooth underside surface. It provides the ultimate exterior hose wall protection with a non-perforated band, which gives more protection to the soft hose surface, during the installation and usage.