

Datasheet

2.77mm Pitch 25 Way Straight Through Hole Mount PCB D-sub Connector, Plug

RS Stock number 528-3727

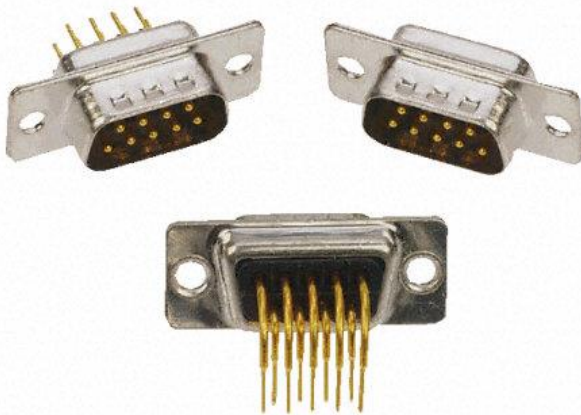

Dimensions

Positions	A	B	C	D	E
9	30.81	24.99	16.92	16.33	19.20
15	39.14	33.32	25.50	24.66	27.70
25	53.04	47.04	38.96	38.38	41.10
37	69.32	63.50	55.42	54.84	57.30

Dimensions: (mm)

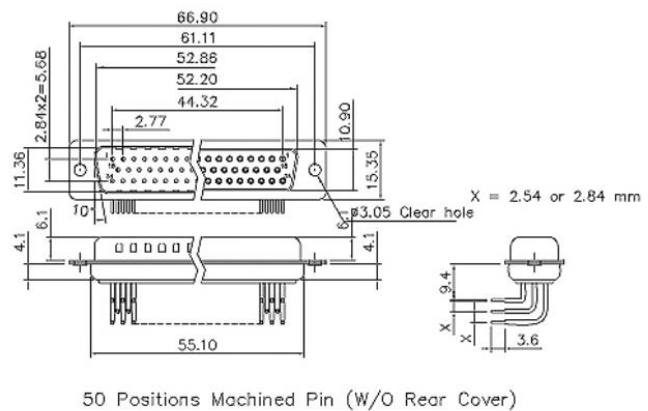
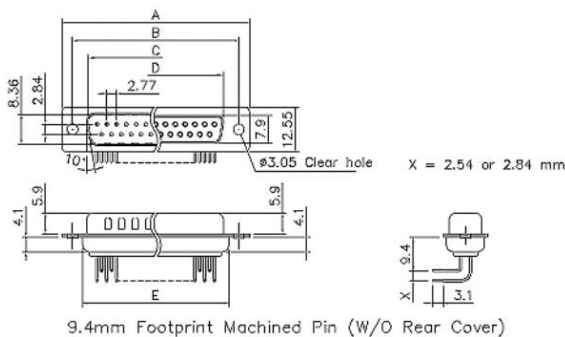

Specification

- Insulator Glass – Filled Thermoplastic PBT UL94V-0
- Contact: Turned Copper Alloy
- Shell: Steel, 100u" tin over 50u" min Nickel
- Contact Resistance: 10 milliohms Max at 1 Amp DC
- Insulation Resistance: 1000 megohms at 500 VDC
- Dielectric Withstanding Voltage: 1000 VAC/ rms 60Hz for 1 minute
- Current Rating: 5 Amp all contacts simultaneously
- Voltage Rating: 250 VAC/rms 60Hz
- Temperature Range: -55°C to 125°C
- Contact Type: Machine Pin
- Contact Plating: Gold plated over Nickel