



ENGLISH

Datasheet

RS Stock No. 1253567

## RS Pro EQi Motor Controller for RS Pro Micro-pumps

### **INTRODUCTION**

The RS Pro EQi control board is highly efficient, small and lightweight device and can be quickly and easily installed into the smallest spaces, in a vast range of laboratory, prototype and production equipment.

The EQi will accept an input voltage of up to 30v DC. The output from the EQi can be controlled by either the on board speed control pot or from an external 0-5v input. The flow direction can be reversed. The speed of the pump is 'Governed' above 12v to maintain a constant flow as the back pressure increases. This provides a flatter pressure/flow curve. Below 12v the pump speed will decrease as the voltage is lowered.

### **ELECTRICAL CONNECTION**

Voltage: up to 30 DC  
Input: 2 screw terminal : UP to 30v/GND  
Output: 3 screw terminal : Phase XYZ

1. Connect the 3 wires of the Micropump to the 3 screw terminals marked 'Phase XYZ'.
2. Connect the Input power to the 2 screw terminals marked 'Up to 30V (+) & GND (-)'.
3. Set Jumper plug for either inboard speed control or external 0-5v control. NOTE: if using the external 0-5 you will need to use the supplied lead to connect to the 3 pin header next to the input power terminals. The RED wire on the lead must go next to input power terminals. Then connect you external 0-5V to the GND (-) and 0-5v (+) wires.
4. If you require to reverse the flow of the pump, connect the 'Direction pin' to 'GND', this will reverse the flow. When the pin is disconnected it will revert to the original flow direction.

Always make all cable connections before powering the EQi.

We suggest that you begin testing with a supply voltage of 12v.

It is advised to use a 'always live' supply voltage as the EQi is instant start. If a slow starting power supply is used it may cause the EQi not to start. If this is the case then turn on PSU first and then connect the EQi.

If using the 0-5V control do not exceed the maximum 5v and always apply the 0-5v after powering up the main input voltage. If using the on board pot control you will notice that the pot does not have stops. This is to protect from pot damage. You can hear the increase/decrease of pump speed as you turn the pot. In both control options you will need 50% setting to start the pump. Do not leave the 0-5 powered if using the pot control, this will damage the EQi.

Datasheet  
RS Stock No. 1253567

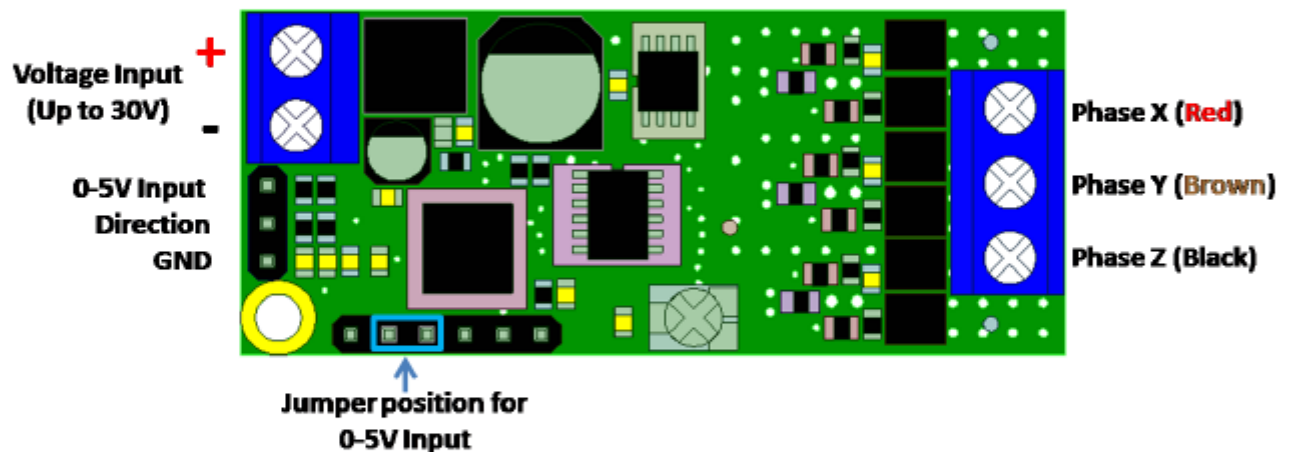
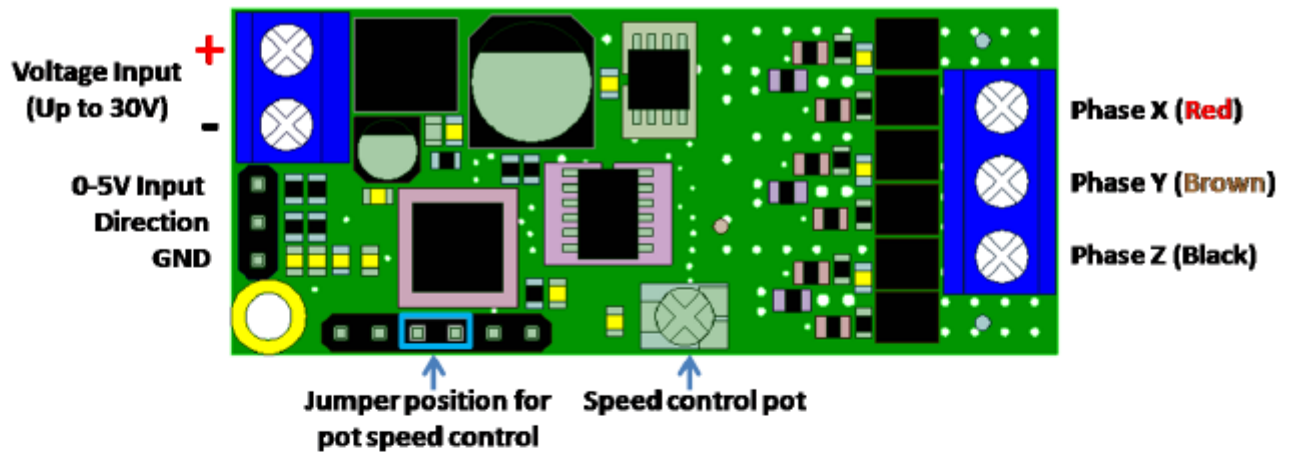

**Maximum Operating Pressure**

MG1000P-	10.0 Bar (145psi)
MG1000S -	8.0Bar (116psi)
MG1000F-	4.0Bar (58psi)

**CAUTION**

Do not exceed the maximum operating pressure for your pump  
Do not exceed the maximum operating current draw of 2 amps.  
Exceeding these limits may cause damage to the Micropump.