

LT8338
**1.2A, 42V Micropower
Synchronous Boost Converter**
DESCRIPTION

Demonstration circuit DC2907A features the [LT®8338](#), a low I_Q , Synchronous Boost Converter in a thermally enhanced 10-lead plastic MSOP package. DC2907A is designed to convert a 4V to 16V source to 24V output, with up to 460mA of load current, depending on the input voltage. It was designed with a switching frequency of 2.2MHz.

DC2907A contains a selectable jumper, JP1, to aid in the selection of any of the five modes of operation. The default setting is Burst mode.

This converter features Spread Spectrum Frequency Modulation, SSFM. The input and output filters installed on the PCB help suppress EMI noise, but the use of SSFM makes it easier to pass CISPR25 class 5 conducted and radiated emissions testing for automotive vehicles. To perform an EMI evaluation for this converter include the input filter by connecting the input source to the VEMI terminal and select the Burst+SSFM JP1 setting.

EMI filters may not be necessary for all applications. For a lower parts count and BOM cost EMI filters can be removed. To do so, replace FB1 and FB2 with a zero ohm jumpers and remove all input and output filter components located inside the dashed-line rectangles on the schematic, plus C1 and C13.

Proper board layout is essential for maximum thermal performance. See the datasheet section “Thermal Considerations”.

The Performance Summary section details the ratings of the DC2907A at room temperature. The LT®8338 datasheet gives a complete description of the part, operation and application information. The data sheet must be read in conjunction with this quick start guide for DC2907A.

The LT®8338 is available in a thermally-enhanced 10 lead plastic MSOP package

[Design files for this circuit board are available.](#)

All registered trademarks and trademarks are the property of their respective owners.

PERFORMANCE SUMMARY Specifications are at $T_A = 25^\circ\text{C}$

PARAMETER	CONDITIONS	MIN	TYP	MAX	UNITS
Input Voltage V_{IN} Range		4	12	16	V
Output Voltage			24		V
V_{IN} turn-on threshold (rising)	R3 = 1Mohm, R4 = 432kohm		3.5		V
V_{IN} UVLO threshold (falling) Under Voltage Lockout	R3 = 1Mohm, R4 = 432kohm		3.3		V
Switching Frequency (f_{SW})	R7 = 40.2k, JP1 = BURST		2.2		MHz
SSFM Switching Frequency range	R7 = 40.2k, JP1 = BURST+SSFM	2.2		2.5	MHz
Efficiency	$V_{IN} = 12\text{V}$, $V_{OUT} = 24\text{V}$, $I_{OUT} = 340\text{mA}$		92.3		%

QUICK START PROCEDURE

DC2907A is easy to set up to evaluate the performance of the LT8338. Refer to Figure 1 for proper measurement equipment setup and follow the procedure below.

NOTE: Make sure that the voltage applied to V_{IN} does not exceed 16V.

1. With power off, connect a power supply to the V_{IN} and GND terminals of DC2907A. Include voltage and current meters as shown if desired.
2. With power off, connect the input power to the DC2907A demo board through V_{IN} and GND, and the load between V_{OUT} and GND.
3. After all connections are made. Turn on the power supply and verify that the input voltage is between 4V and 16V.

4. Check for the proper output voltage. If there is no output, disconnect the load to make sure the load is not set too high.
5. Once the proper output voltage is established, adjust the input voltage and load current within the operating range and observe the output voltage regulation, ripple voltage, efficiency and other parameters.
6. When measuring the output voltage ripple, care must be taken to avoid a long ground lead on the oscilloscope probe. Measure the output voltage ripple by touching the probe tip directly across the V_{OUT} and GND terminals. See Figure 2 for proper scope probe technique.

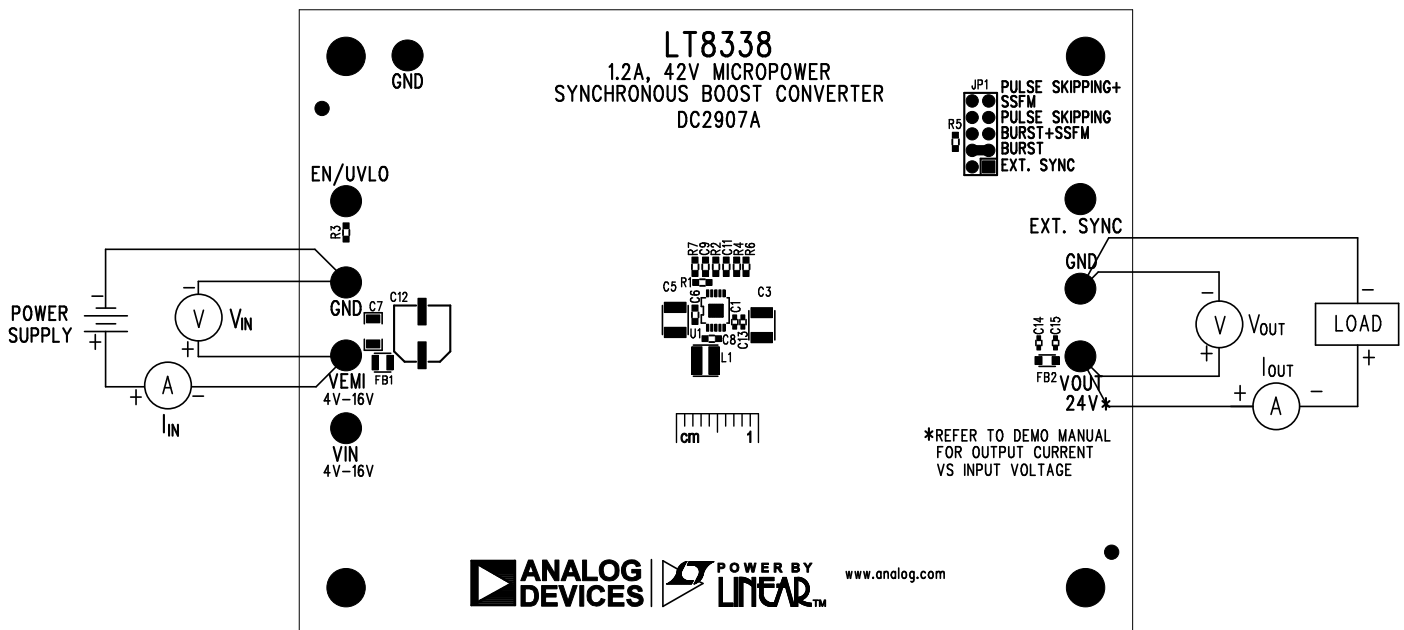

Figure 1. Proper Measurement Equipment Setup

QUICK START PROCEDURE

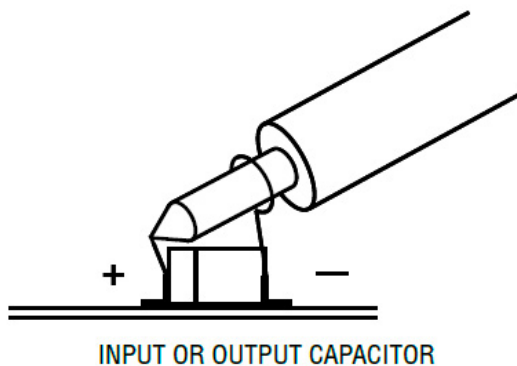

Figure 2. Proper Scope Probe Placement for Measuring Output Ripple

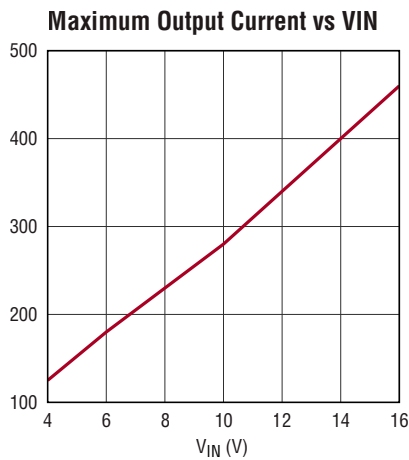

Figure 3. Maximum Output Current vs Input Voltage

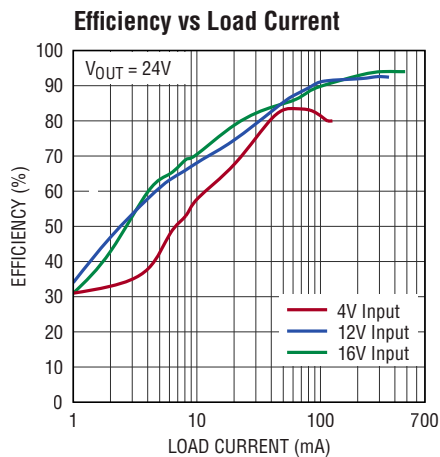
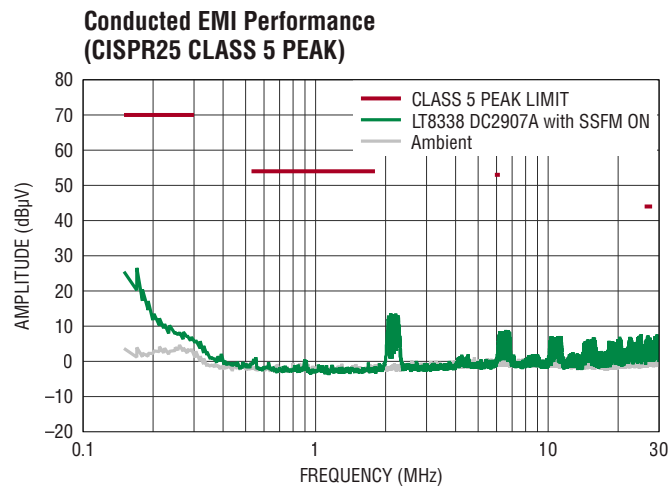
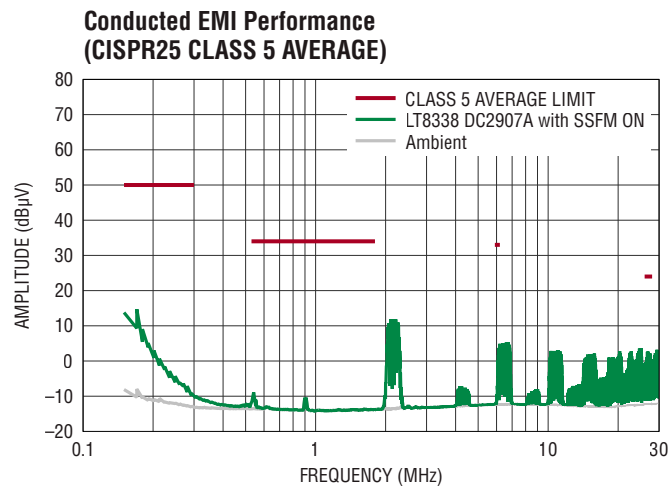

Figure 4. Efficiency vs Load Current

QUICK START PROCEDURE



(5a)



(5b)

Figure 5. DC2907 Conducted EMI Results with CISPR25 Class 5 Limit Lines

QUICK START PROCEDURE

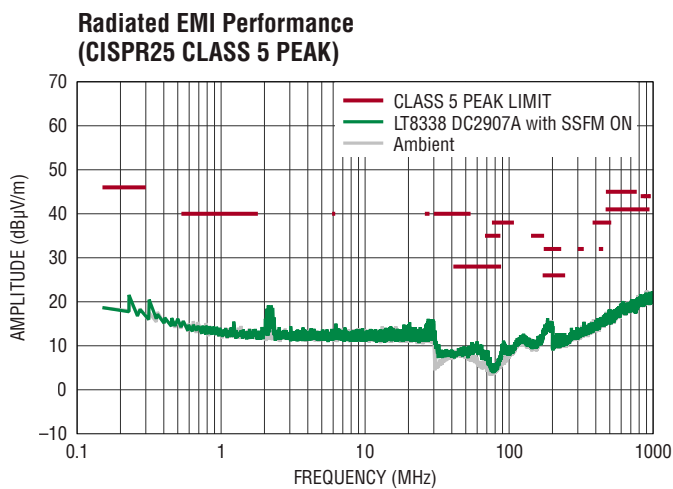

(6a)

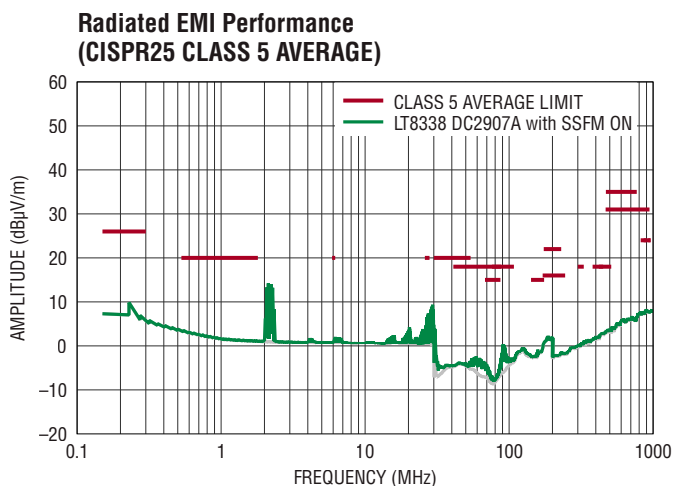

(6b)

Figure 6. DC2907 Radiated EMI Results with CISPR25 Class 5 Limit Lines

DEMO MANUAL DC2907A

PARTS LIST

ITEM	QTY	REFERENCE	PART DESCRIPTION	MANUFACTURER/PART NUMBER
Required Circuit Components				
1	2	C3, C5	CAP., 10uF X7S, 50V, 10%, 1210	TAIYO YUDEN, UMK325C7106KM-P
2	1	C6	CAP., 0.1uF, X7R, 50V, 10%, 0603, AEC-Q200	TDK, CGA3E2X7R1H104K
3	1	C8	CAP., 0.1uF, X7R, 25V, 10%, 0603	AVX, 06033C104KAT2A
4	1	C9	CAP., 2.2uF, X5R, 16V, 10%, 0603	AVX, 0603YD225KAT2A
5	1	C11	CAP., 0.01uF, X7R, 50V, 10%, 0603	AVX, 06035C103KAT2A
6	1	L1	IND., 4.7uH, PWR, 20%, 1.9A, 158mOHMS, 2-SMD	WURTH ELEKTRONIK, 74438336047
7	1	R1	RES., 953K OHMS, 1%, 1/10W, 0603, AEC-Q200	VISHAY, CRCW0603953KFKEA
8	2	R2, R3	RES., 1M OHM, 1%, 1/10W, 0603, AEC-Q200	VISHAY, CRCW06031M00FKEA
9	1	R4	RES., 432k OHMS, 1%, 1/10W, 0603, AEC-Q200	VISHAY, CRCW0603432KFKEA
10	1	R5	RES., 100k OHMS, 1%, 1/10W, 0603, AEC-Q200	VISHAY, CRCW0603100KFKEA
11	1	R6	RES., 40.2k OHMS, 1%, 1/10W, 0603, AEC-Q200	VISHAY, CRCW060340K2FKEA
12	1	R7	RES., 10k OHMS, 1%, 1/10W, 0603, AEC-Q200	VISHAY, CRCW060310K0FKEA
13	1	U1	IC, BOOST CONVERTER, MSOP-10	ANALOG DEVICES, LT8338EMSE#PBF
Optional EMI Components				
1	1	C7	CAP., 4.7uF, X7R, 50V, 10%, 1206	MURATA, GRM31CR71H475KA12L
2	1	FB1	IND., 0.47uH, PWR, SHIELDED, 20%, 2.1A, 50mOHMS, 0806, MULTILAYER	WURTH ELEKTRONIK, 74479876147
3	1	FB2	IND., 600 OHMS@100MHz, FERRITE BEAD, 25%, 2A, 150mOHMS, 0805	WURTH ELEKTRONIK, 742792040
4	4	C1, C13-C15	CAP., 0.1uF, X5R, 100V, 10%, 0402, NO SUBS. ALLOWED	MURATA, GRM155R62A104KE14D
5	1	C12	CAP., 33uF, ALUM. ELECT., 50V, 20%, 6.3mmX7.7mm	SUN ELECTRONIC INDUSTRIES CORP, 50CE33BS
Hardware: For Demo Board Only				
1	8	E1-E8	TEST POINT, TURRET, 0.094" MTG. HOLE, PCB 0.062" THK	MILL-MAX, 2501-2-00-80-00-00-07-0
2	1	JP1	CONN., HDR, MALE, 2x5, 2mm, VERT, ST, THT	WURTH ELEKTRONIK, 62001021121
3	4	MP1-MP4	STANDOFF, NYLON, SNAP-ON, 0.25" (6.4mm)	KEYSTONE, 8831
4	1	XJP1	CONN., SHUNT, FEMALE, 2 POS, 2mm	WURTH ELEKTRONIK, 60800213421

SCHEMATIC DIAGRAM

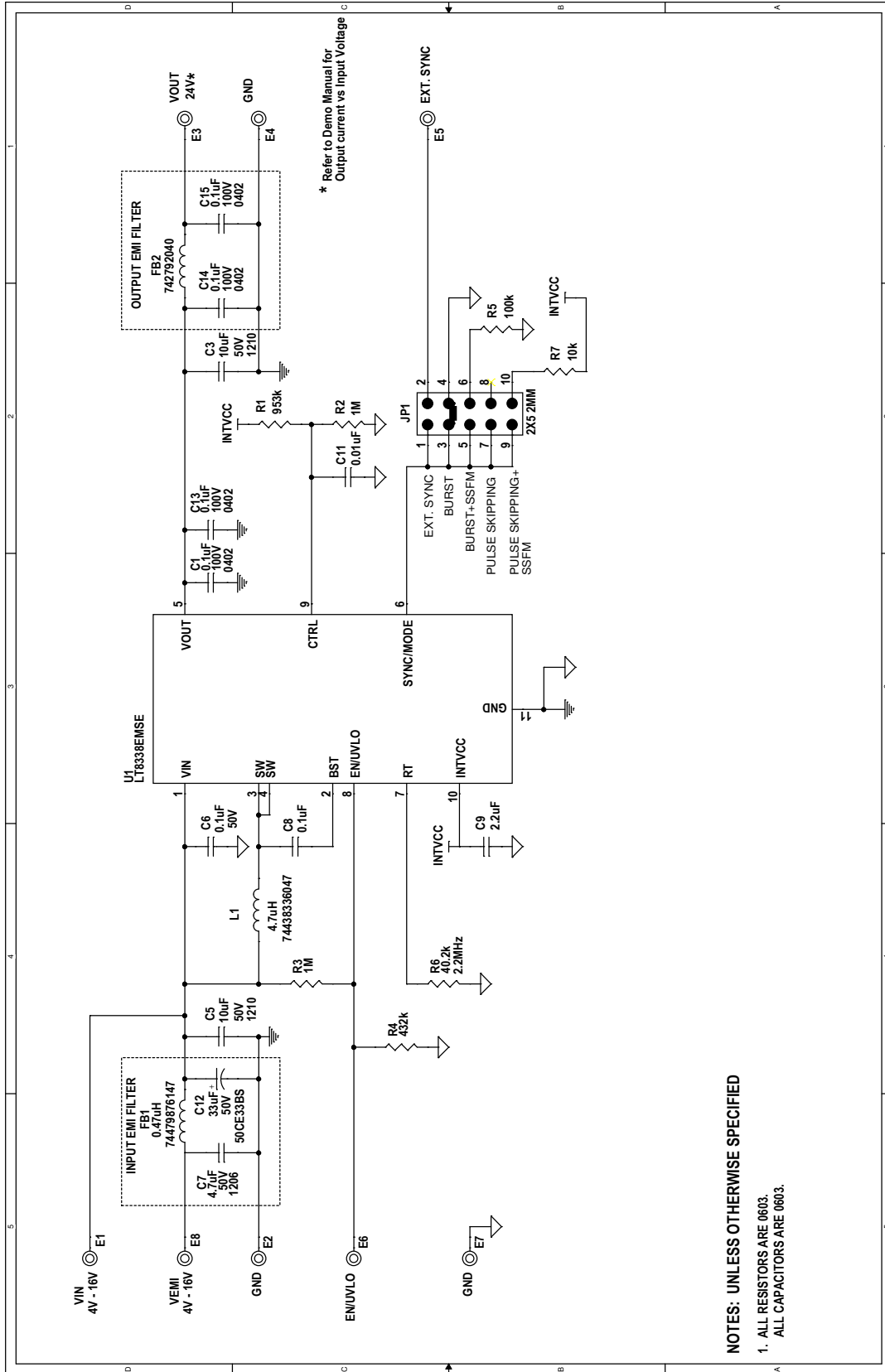

NOTES: UNLESS OTHERWISE SPECIFIED

- 1. ALL RESISTORS ARE 0603.
- ALL CAPACITORS ARE 0603.



ESD Caution

ESD (electrostatic discharge) sensitive device. Charged devices and circuit boards can discharge without detection. Although this product features patented or proprietary protection circuitry, damage may occur on devices subjected to high energy ESD. Therefore, proper ESD precautions should be taken to avoid performance degradation or loss of functionality.

Legal Terms and Conditions

By using the evaluation board discussed herein (together with any tools, components documentation or support materials, the "Evaluation Board"), you are agreeing to be bound by the terms and conditions set forth below ("Agreement") unless you have purchased the Evaluation Board, in which case the Analog Devices Standard Terms and Conditions of Sale shall govern. Do not use the Evaluation Board until you have read and agreed to the Agreement. Your use of the Evaluation Board shall signify your acceptance of the Agreement. This Agreement is made by and between you ("Customer") and Analog Devices, Inc. ("ADI"), with its principal place of business at One Technology Way, Norwood, MA 02062, USA. Subject to the terms and conditions of the Agreement, ADI hereby grants to Customer a free, limited, personal, temporary, non-exclusive, non-sublicensable, non-transferable license to use the Evaluation Board FOR EVALUATION PURPOSES ONLY. Customer understands and agrees that the Evaluation Board is provided for the sole and exclusive purpose referenced above, and agrees not to use the Evaluation Board for any other purpose. Furthermore, the license granted is expressly made subject to the following additional limitations: Customer shall not (i) rent, lease, display, sell, transfer, assign, sublicense, or distribute the Evaluation Board; and (ii) permit any Third Party to access the Evaluation Board. As used herein, the term "Third Party" includes any entity other than ADI, Customer, their employees, affiliates and in-house consultants. The Evaluation Board is NOT sold to Customer; all rights not expressly granted herein, including ownership of the Evaluation Board, are reserved by ADI. CONFIDENTIALITY. This Agreement and the Evaluation Board shall all be considered the confidential and proprietary information of ADI. Customer may not disclose or transfer any portion of the Evaluation Board to any other party for any reason. Upon discontinuation of use of the Evaluation Board or termination of this Agreement, Customer agrees to promptly return the Evaluation Board to ADI. ADDITIONAL RESTRICTIONS. Customer may not disassemble, decompile or reverse engineer chips on the Evaluation Board. Customer shall inform ADI of any occurred damages or any modifications or alterations it makes to the Evaluation Board, including but not limited to soldering or any other activity that affects the material content of the Evaluation Board. Modifications to the Evaluation Board must comply with applicable law, including but not limited to the RoHS Directive. TERMINATION. ADI may terminate this Agreement at any time upon giving written notice to Customer. Customer agrees to return to ADI the Evaluation Board at that time. LIMITATION OF LIABILITY. THE EVALUATION BOARD PROVIDED HEREUNDER IS PROVIDED "AS IS" AND ADI MAKES NO WARRANTIES OR REPRESENTATIONS OF ANY KIND WITH RESPECT TO IT. ADI SPECIFICALLY DISCLAIMS ANY REPRESENTATIONS, ENDORSEMENTS, GUARANTEES, OR WARRANTIES, EXPRESS OR IMPLIED, RELATED TO THE EVALUATION BOARD INCLUDING, BUT NOT LIMITED TO, THE IMPLIED WARRANTY OF MERCHANTABILITY, TITLE, FITNESS FOR A PARTICULAR PURPOSE OR NON-INFRINGEMENT OF INTELLECTUAL PROPERTY RIGHTS. IN NO EVENT WILL ADI AND ITS LICENSORS BE LIABLE FOR ANY INCIDENTAL, SPECIAL, INDIRECT, OR CONSEQUENTIAL DAMAGES RESULTING FROM CUSTOMER'S POSSESSION OR USE OF THE EVALUATION BOARD, INCLUDING BUT NOT LIMITED TO LOST PROFITS, DELAY COSTS, LABOR COSTS OR LOSS OF GOODWILL. ADI'S TOTAL LIABILITY FROM ANY AND ALL CAUSES SHALL BE LIMITED TO THE AMOUNT OF ONE HUNDRED US DOLLARS (\$100.00). EXPORT. Customer agrees that it will not directly or indirectly export the Evaluation Board to another country, and that it will comply with all applicable United States federal laws and regulations relating to exports. GOVERNING LAW. This Agreement shall be governed by and construed in accordance with the substantive laws of the Commonwealth of Massachusetts (excluding conflict of law rules). Any legal action regarding this Agreement will be heard in the state or federal courts having jurisdiction in Suffolk County, Massachusetts, and Customer hereby submits to the personal jurisdiction and venue of such courts. The United Nations Convention on Contracts for the International Sale of Goods shall not apply to this Agreement and is expressly disclaimed.