

FEATURES

- Ultra-wide DIN rail mount DC-DC
 - 9...36Vdc
 - 18...75Vdc
- Efficiency up to 88%
- I/O isolation test voltage 1.5k VDC
- Industry standard pin-out
- Operating temperature range - 40°C to +105°C
- Input under-voltage protection, output short circuit, over-current, over-voltage protection.
- EMI performance meets CISPR32 / EN55032 Class A without extra components
- EN62368 Approved

RS PRO 6W PCB mount wide Input DC-DC

2351358, 2351361, 2351363, 2351370, 2351375, 2351379, 2351383, 2351385, 2351389, 2351392

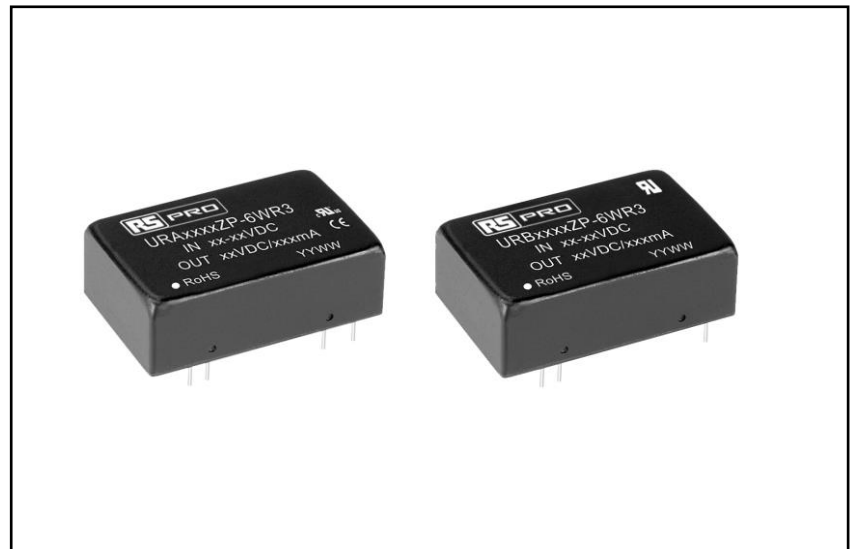

RS Professionally Approved Products bring to you professional quality parts across all product categories. Our product range has been tested by engineers and provides a comparable quality to the leading brands without paying a premium price.

Embedded Switch Mode Power Supplies (SMPS)

Product Description

PCB mount DC-DC converters feature an ultra-wide 4:1 input voltage with efficiencies of up to 88%, 1500VDC input to output isolation, an operating ambient temperature range of -40°C to +85°C, input undervoltage protection, output overvoltage, overcurrent, short circuit protection, CISPR32/EN55032 CLASS A EMI compliant without external components, which makes them widely used in industrial control, instrumentation and communications applications.

General Specifications

Model	DC-DC 6W Industrial PCB power supply
Mounting Type	PCB mount
MTBF	MIL-HDBK-217F@25°C > 1,000,000 hrs
Applications	Industrial control systems, instrumentation and equipment

RS Stock#	Input Voltage (Vdc)		Output Voltage	Output Current	Max. Capacitive Load(μF)	Efficiency (Typ)
	Input Voltage	Max				
2351370	9 to 36Vdc	40	3.3V	1.5A	1800	79%
2351375			5V	1.2A	1000	83%
2351379			12V	0.5A	470	87%
2351383			15V	0.4A	220	88%
2351385			24V	0.25A	100	87%
2351358			±5V	±0.6A	680	83%
2351361			±12V	±0.25A	330	87%
2351363			±15V	±0.2A	220	88%
2351389			18 to 75Vdc	80	5V	1.2A
2351392	12V	0.5A			470	87%

Input Specifications

Input Specification					
Item	Operating Conditions	Min.	Typ.	Max.	Unit
Input Current (full load / no-load)	24VDC nominal input series, nominal input voltage	-	316/5	325/12	mA
	48VDC nominal input series, nominal input	-	156/4	160/8	
Reflected Ripple Current		-	20	-	
Surge Voltage (1sec. max.)	24VDC nominal input series	-0.7	-	50	VDC
	48VDC nominal input series	-0.7	-	100	
Start-up Voltage	24VDC nominal input series	-	-	9	
	48VDC nominal input series	-	-	18	
Input under-voltage protection	24VDC nominal input series	5.5	6.5	-	
	48VDC nominal input series	12	15.5	-	
Input Filter		Pi filter			
Hot Plug		Unavailable			

Output Specifications

Output Specification							
Item	Operating Conditions		Min	Typ.	Max	Unit	
Voltage Accuracy	Vo1		-	±1	±3	%	
	Vo2						
Linear Regulation	Input voltage variation from low to high at full load	Vo1	-	±0.2	±0.5		
		Vo2		±0.5	±1		
Load Regulation	5%-100% load	Vo1	-	±0.5	±1		
		Vo2		±0.5	±1.5		
Cross Regulation	Dual outputs, Vo1 load at 50%, Vo2 load at range of 10%-100%		-	-	±5		
Transient Recovery Time			-	300	500		µs
Transient Response Deviation	25% load step change, nominal input voltage	3.3V, 5V and ±5V output	-	±5	±8		%
		Others	-	±3	±5		
Temperature Coefficient	Full load		-	-	±0.03	%/°C	
Ripple & Noise *	20MHz bandwidth, 100% load		-	-	85	mV p-p	
Over-voltage Protection	Input voltage range		110	-	160	%Vo	
Over-current Protection	Input voltage range		110	140	190	%Io	
Short circuit Protection	Input voltage range		Continuous, self-recovery				
Note: ① Output voltage accuracy of ±5VDC output converter for 0%-5% load is ±5% max, ② Load regulation for 0%-100% load is ±5%, ③ The “parallel cable” method is used for Ripple and Noise test, please refer to DC-DC Converter Application Notes for specific information							

Embedded Switch Mode Power Supplies (SMPS)

Derating

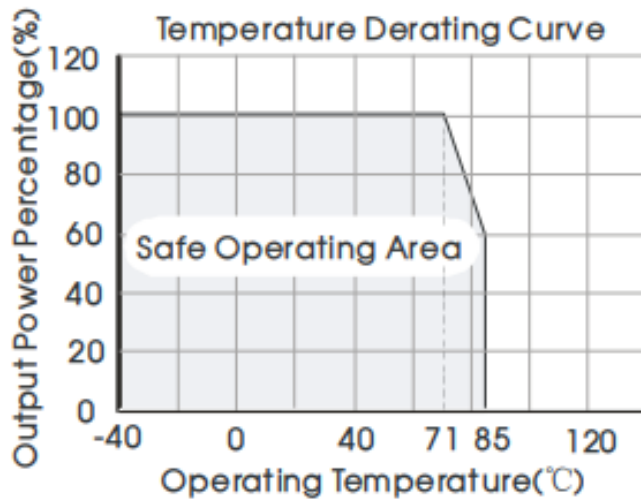

Fig. 1

General Specifications

Item	Operating Conditions	Min	Typ	Max.	Unit
Isolation	Input-output Electric Strength Test for 1 minute with a leakage current	1500	-	-	VDC
Insulation Resistance	Input-output resistance at 500VDC	1000	-	-	MΩ
Isolation Capacitance	Input-output capacitance at 100kHz/0.1V		1000		pF
Operating Temperature	See Fig. 1	-40	-	+85	°C
Storage Temperature		-55	-	+125	
Storage Humidity	Non-condensing	5	-	95	%RH
MTBF	MIL-HDBK-217F@25°C	1000			K hours
Pin Soldering Resistance Temperature	Soldering spot is 1.5mm away from case for 10 seconds	-	-	+300	°C
Vibration(EN50155)		IEC/EN61373 - Category 1, Grade B			
Switching Frequency *	PWM mode	-	300	-	KHz

Note: * Switching frequency is measured at full load. The module reduces the switching frequency for light load (below 50%) efficiency improvement.

EMC Specifications

Electromagnetic Compatibility (EMC)		
Emissions	CE	CISPR32/EN55032 CLASS A (without extra components)/ CLASS B (see Fig.3-② for recommended circuit)
	RE	CISPR32/EN55032 CLASS A (without extra components)/ CLASS B (see Fig.3-② for recommended circuit)
Immunity	ESD	IEC/EN61000-4-2 Contact $\pm 4\text{KV}$ perf. Criteria B
	RS	IEC/EN61000-4-3 10V/m perf. Criteria A
	EFT	IEC/EN61000-4-4 $\pm 2\text{KV}$ (see Fig.3-① for recommended circuit) perf. Criteria B
	Surge	IEC/EN61000-4-5 line to line $\pm 2\text{KV}$ (see Fig.3-① for recommended circuit) perf. Criteria B
	CS	IEC/EN61000-4-6 3 Vr.m.s perf. Criteria A
	Immunities of voltage dip, drop and short interruption	IEC/EN61000-4-29 0%, 70% perf. Criteria B

Electromagnetic Compatibility (EMC) (EN50155)		
Emissions	CE	EN50121-3-2 150kHz-500kHz 99dB μV (see Fig.3-② for recommended circuit) EN55016-2-1 500kHz-30MHz 93dB μV (see Fig.3-② for recommended circuit)
	RE	EN50121-3-2 30MHz-230MHz 40dB $\mu\text{V}/\text{m}$ at 10m (see Fig.3-② for recommended circuit) EN55016-2-1 230MHz-1GHz 47dB $\mu\text{V}/\text{m}$ at 10m (see Fig.3-② for recommended circuit)
Immunity	ESD	EN50121-3-2 Contact $\pm 6\text{KV}/\text{Air } \pm 8\text{KV}$ perf. Criteria A
	RS	EN50121-3-2 20V/m perf. Criteria A
	EFT	EN50121-3-2 $\pm 2\text{kV}$ 5/50ns 5kHz(see Fig.3-① for recommended circuit) perf. Criteria A
	Surge	EN50121-3-2 line to line $\pm 1\text{KV}$ (42 Ω , 0.5 μF) (see Fig.3-① for recommended circuit) perf. Criteria A
	CS	EN50121-3-2 0.15MHz-80MHz 10 Vr.m.s perf. Criteria A

Embedded Switch Mode Power Supplies (SMPS)

1. Typical Application

All the DC/DC converters of this series are tested before delivery using the recommended circuit shown in Fig. 2. Input and/or output ripple can be further reduced by appropriately increasing the input & output capacitor values C_{in} and C_{out} and/or by selecting capacitors with a low ESR (equivalent series resistance). Also make sure that the capacitance is not exceeding the specified max. capacitive load value of the product.

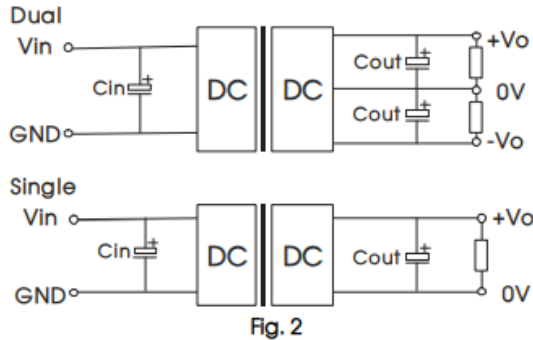

Vin(VDC)	Cin	Vo(VDC)	Cout
24	100µF/50V	3.3/5/9/±5/±9	10µF/16V
		12/15/±12/±15	10µF/25V
		24/±24	10µF/50V
48	10µF/100V~47µF/100V	3.3/5/9/±5	10µF/16V
		12/15/±12/±15	10µF/25V
		24	10µF/50V

EMC compliance circuit

Dual output:

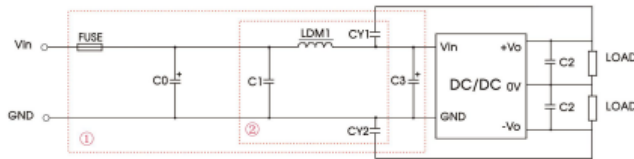

Single output:

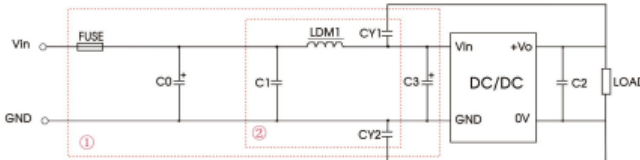

Fig. 3

Notes: For EMC tests we use Part ① in Fig. 3 for immunity and part ② for emissions test. Selecting based on needs.

Parameter description:

Model	Vin:24VDC	Vin:48VDC
FUSE	Choose according to actual input current	
C0/C3	330µF/50V	330µF/100V
C1	1µF/50V	1µF/100V
C2	Refer to the Cout in Fig.2	
LDM1	4.7µH	
CY1/CY2	1nF/2KV	

Mechanical Specifications

Case material	Aluminium alloy
Dimensions	32.00 x 20.00 x 10.80mm
Weight	12g (Typ.)
Cooling Method	Free air convection

Embedded Switch Mode Power Supplies (SMPS)

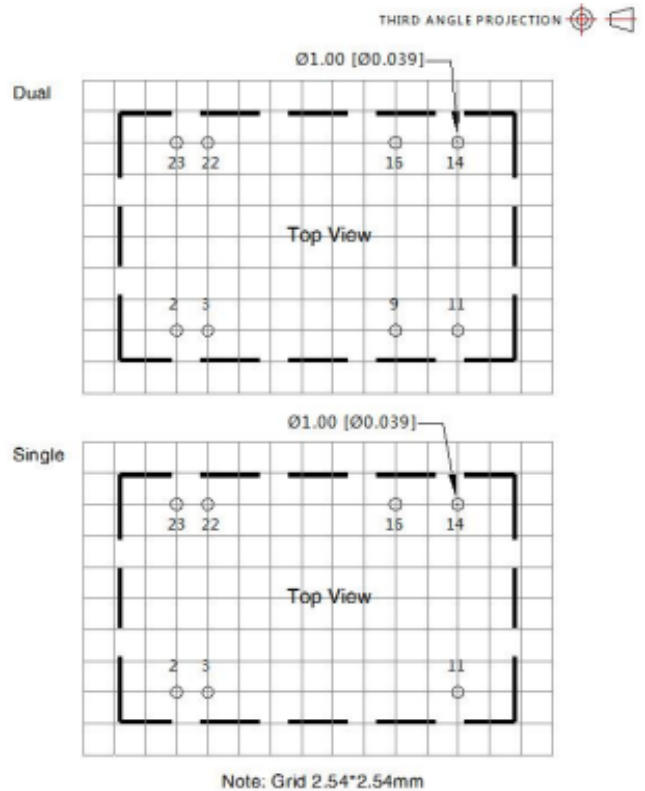
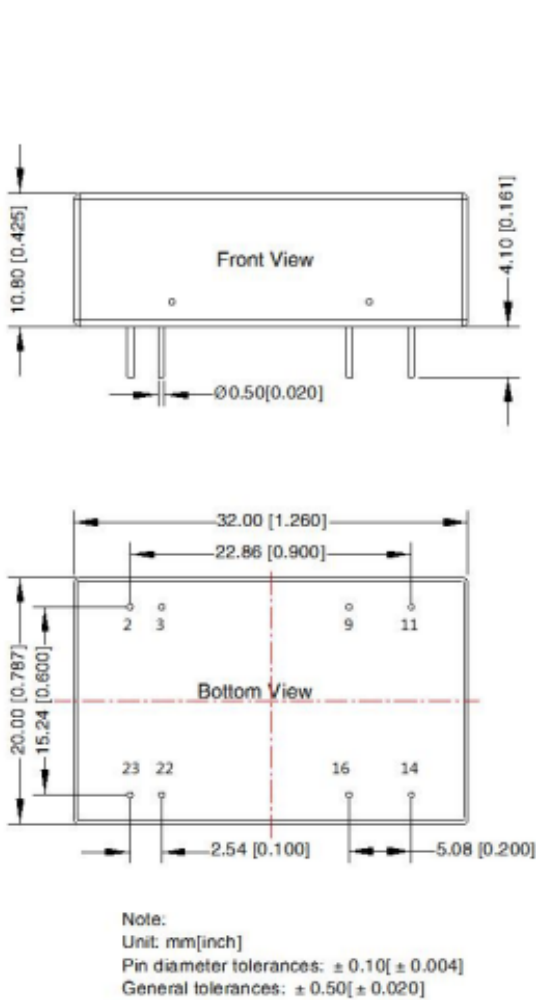

Pin	Pin-Out	
	Single	Dual
2,3	GND	GND
9	No Pin	0V
11	NC	-Vo
14	+Vo	+Vo
16	0V	0V
22,23	Vin	Vin

NC: Pin to be isolated from circuit

Approvals

Safety	EN62368
--------	---------

1. If the product is not operated within the required load range, the product performance cannot be guaranteed to comply with all parameters in the datasheet.
2. The maximum capacitive load offered were tested at input voltage range and full load.
3. Unless otherwise specified, parameters in this datasheet were measured under the conditions of Ta=25°C, humidity