



# Harmony XB5 Plastic

Control and signaling units



# Harmony

## Discover [Harmony](#)

Advanced operator interface and industrial relays

Harmony operator interface and industrial relays enhance operational efficiency and equipment availability across industrial and building applications. Harmony includes intelligent connected products and edge terminals that visualize, gather and process data, enabling informed operator decisions

## Explore our offer

- [Harmony](#) Push Buttons and Switches
- [Harmony](#) HMI Operator Terminals, IPC and EdgeBox
- [Harmony](#) Signaling Devices
- [Harmony](#) Electrical Relays
- [Harmony](#) Safety

# Quick access to product information

## Get technical information about your product

References

**Modicon TM3**  
I/O expansion modules for Modicon controllers  
Analog I/O modules

Number and type of channels	Input range	Output range	Resolution	Input terminal (Modicon TM3)	Reference	Weight (kg)
2 enhancement inputs	-10...+10 VDC 0...20 mA I, 20 mA	0...12 bits or 0...12 bits or 12 bits	12 bits or 12 bits	Terminal 2	TM3AI2H	0.110
4 enhancement inputs	-10...+10 VDC 0...20 mA I, 20 mA	0...12 bits or 0...12 bits or 12 bits	12 bits or 12 bits	Terminal 2	TM3AI2H	0.110
4 enhancement or temperature inputs	Thermocouples (K, J, E, S, T, R, C, D) RTDs (Pt100, Ni100, Ni200, Pt500, Pt1000) -10...+10 VDC 0...20 mA I, 20 mA	0...12 bits or 0...12 bits or 12 bits	12 bits or 12 bits	Terminal 2	TM3AI2H	0.110
4 differential temperature inputs	Thermocouples (K, J, E, S, T, R, C, D) RTDs (Pt100, Ni100, Ni200, Pt500, Pt1000) -10...+10 VDC 0...20 mA I, 20 mA	0...12 bits or 0...12 bits or 12 bits	12 bits or 12 bits	Terminal 2	TM3AI2H	0.110
2 enhancement	-10...+10 VDC	0...12 bits or 0...12 bits or 12 bits	12 bits or 12 bits	Terminal 2	TM3AI2H	0.110

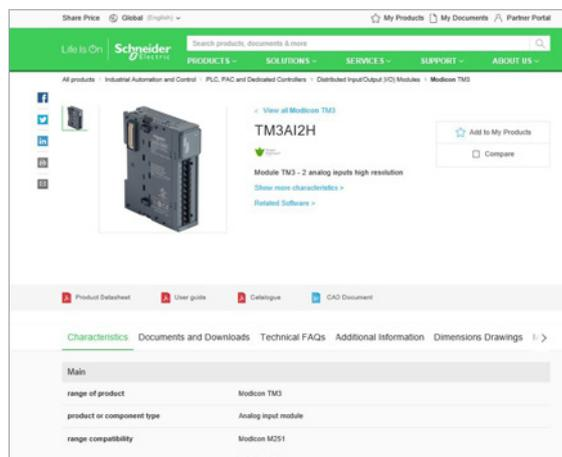

Each commercial reference presented in a catalog contains a hyperlink. Click on it to obtain the technical information of the product:

- Characteristics, Dimensions and drawings, Mounting and clearance, Connections and schemas, Performance curves
- Product image, Instruction sheet, User guide, Product certifications, End of life manual

## Find your catalog

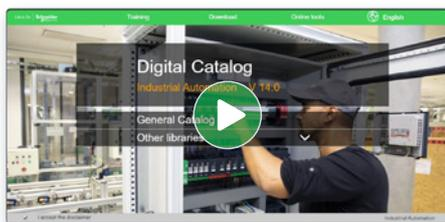

- > With just 3 clicks, you can access the Industrial Automation and Control catalogs, in both English and French
- > Consult digital automation catalogs at [Digi-Cat Online](#)

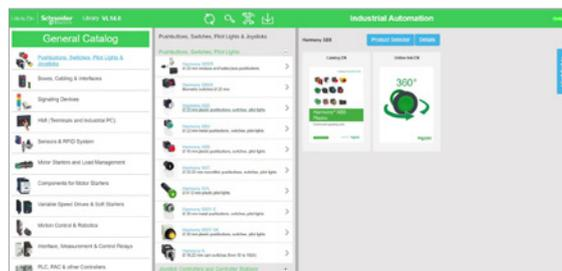

- Up-to-date catalogs
- Embedded product selectors, 360° pictures
- Optimized search by commercial references

## Select your training



- > Find the right [Training](#) for your needs on our Global website
- > Locate the training center with the selector tool, using this [link](#)

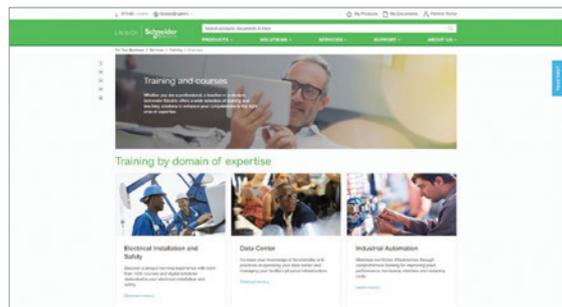

# General contents

## Harmony XB5 plastic

■ <b>General presentation</b> .....	<a href="#">page 3</a>
■ <b>Presentation</b>	
□ Presentation, installation, and environment.....	<a href="#">page 12</a>
<b>Selection guide</b> .....	<a href="#">page 14</a>
■ <b>Description</b>	
□ Complete units, XB5A.....	<a href="#">page 16</a>
□ Sub-assemblies, ZB5A and ZB5F.....	<a href="#">page 18</a>
■ <b>Installation</b>	
□ Contact mounting - Contact sequence.....	<a href="#">page 26</a>
■ <b>References for Diameter 22 mm mounting</b>	
□ Spring return pushbuttons, unmarked and with marking.....	<a href="#">page 29</a>
□ Illuminated pushbuttons, spring return	
- With Universal LED and BA 9s base fitting.....	<a href="#">page 33</a>
□ Multiple-headed pushbuttons, spring return.....	<a href="#">page 37</a>
□ Mushroom head pushbuttons, spring return and latching.....	<a href="#">page 39</a>
□ Emergency stop and Emergency switching off functions.....	<a href="#">page 41</a>
□ Illuminated Emergency stop and Emergency switching off function.....	<a href="#">page 43</a>
□ Emergency stop with monitoring contacts and circular yellow legends.....	<a href="#">page 44</a>
□ Accessories for pushbuttons.....	<a href="#">page 47</a>
□ General safe stop.....	<a href="#">page 50</a>
□ Large head pushbuttons with integrated bellows.....	<a href="#">page 51</a>
□ Pushbuttons and illuminated pushbuttons, push-push.....	<a href="#">page 52</a>
□ Pushbuttons, “push-turn to release”.....	<a href="#">page 53</a>
□ Selector switches	
- With standard handle and long handle.....	<a href="#">page 54</a>
- Key switches, knurled knob, and toggle switches.....	<a href="#">page 56</a>
- Illuminated, with standard handle and Universal LED.....	<a href="#">page 58</a>
□ Pilot lights	
- With Universal LED and BA 9s base fitting.....	<a href="#">page 60</a>
- 3-phase pilot light with Universal LED, push-to-test pilot light.....	<a href="#">page 63</a>
□ Specific functions	
- Manual overload reset pushbuttons, potentiometers.....	<a href="#">page 64</a>
- Timers, hour counters, Annunciators, USB/RJ45 ports, Fuse carrier, Basic display, and Configurable display.....	<a href="#">page 65</a>
- Joystick controllers with screw clamp terminal connections.....	<a href="#">page 67</a>
□ Accessories	
- For heads.....	<a href="#">page 68</a>
- Legends, legend holders, legends panel, and illuminated rings.....	<a href="#">page 71</a>
■ <b>References for diameter 30 mm, Flush mounted</b>	
□ Flush mounted spring return pushbutton, unmarked and with marking.....	<a href="#">page 79</a>
□ Flush mounted illuminated pushbutton, spring return	
- With Universal LED.....	<a href="#">page 82</a>
□ Flush mounted pushbuttons with push-push, illuminated and non-illuminated.....	<a href="#">page 85</a>
□ Flush mounted selector switches	
- With standard handle and long handle.....	<a href="#">page 87</a>
- Key switches, and with knurled knob.....	<a href="#">page 89</a>
- Illuminated, with standard handle and Universal LED.....	<a href="#">page 91</a>
□ Flush mounted pilot light with Universal LED.....	<a href="#">page 92</a>
■ <b>Common components and accessories</b>	
□ Body/contact assemblies and light blocks.....	<a href="#">page 101</a>
■ <b>Product reference index</b> .....	<a href="#">page 116</a>

# Control and signaling units

Pushbuttons, switches, and pilot lights



Life Is On

**Schneider**  
Electric

# Control and signaling units

Harmony XB5 plastic

Pushbuttons, switches, and pilot lights

The Harmony XB5 range of plastic pushbuttons, switches, and pilot lights combines simplicity of installation, flexibility, and robustness to meet the majority of industrial applications. It delivers one of the most comprehensive product ranges available on the market and meets the robustness and performance requirements for the majority of industrial applications.



Complete unit for repetitive orders XB5AA31



Sub-assembly (for additional flexibility) ZB5AZ101 + ZB5AA3

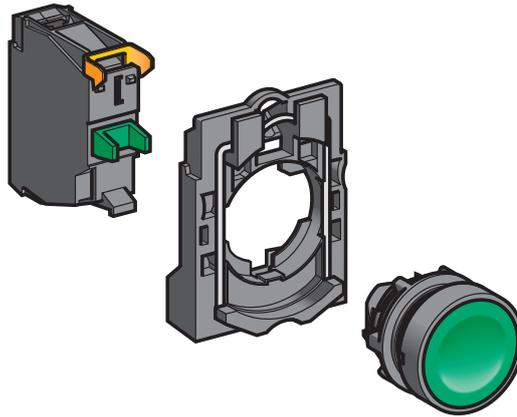

Basic elements (for optimum flexibility) ZBE101 + ZB5AZ009 + ZB5AA3

## A single provider

Our team of experts understands the needs of our customers in terms of their processes and applications. The Harmony ranges are available globally wherever you need them.

## The confidence of a market leader

- > More than 50 years' experience designing switches, pushbuttons, and pilot lights
- > A global network of partners and distributors you know and trust
- > Worldwide product availability with over 17,000 points of sale in more than 100 countries



A global network of partners you can rely on to support customized end-to-end solutions

# Control and signaling units

Harmony XB5 plastic

Pushbuttons, switches, and pilot lights

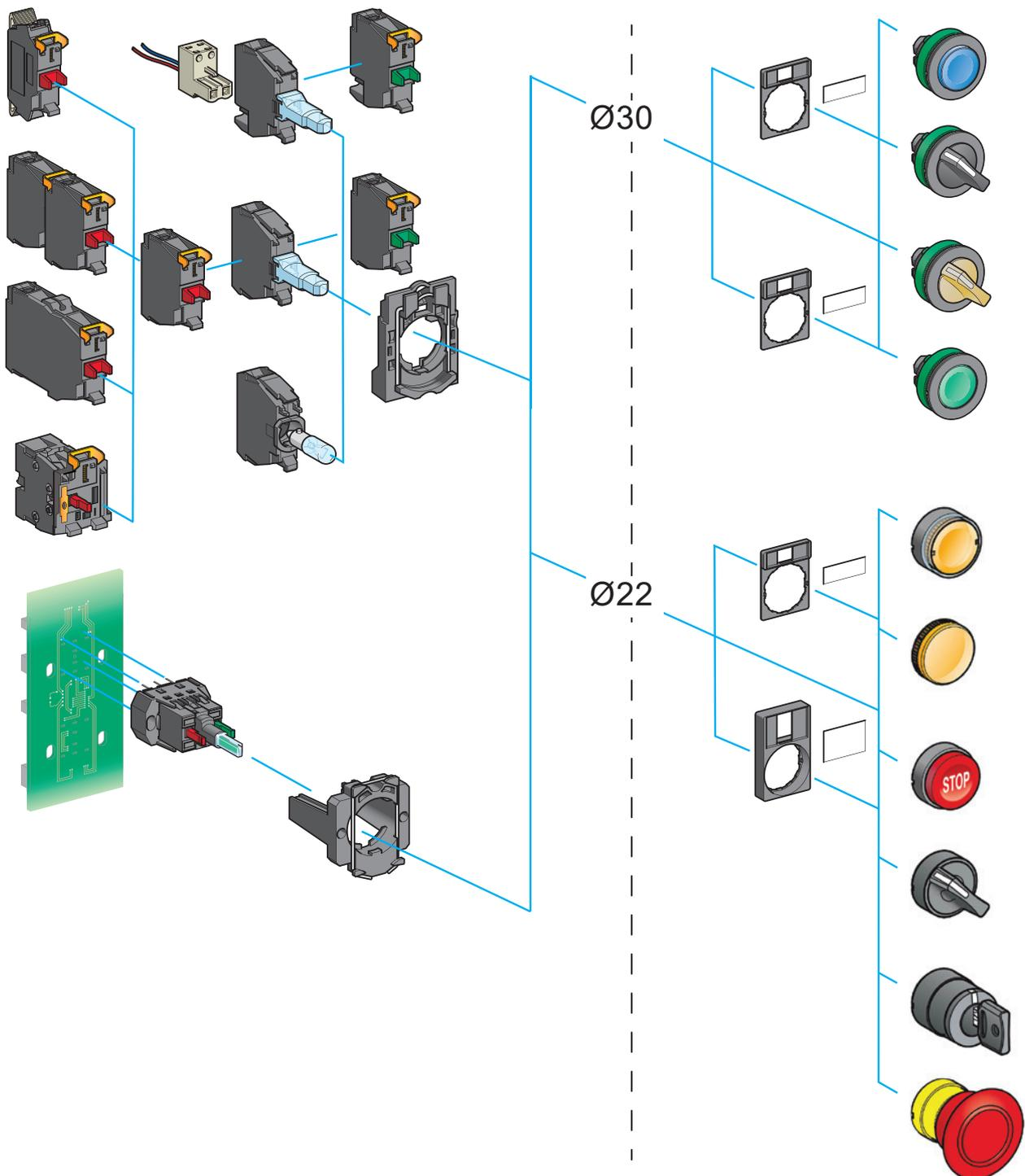

360°

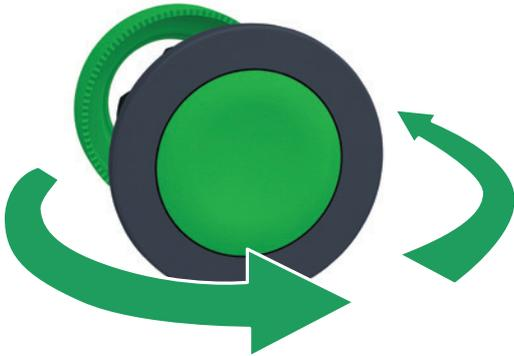

360° view  
Click on the image for 3D view



Customized products

#### Modern design

Harmony delivers an innovative and ergonomic design that allows easy operation and improves the look and feel of your control panels and machines.

#### Improved reliability of panels, machines, and processes

- > The flush-mounting solution addresses the market demands for ergonomic design and aesthetics
- Built-in flush pushbuttons
- Flush mounting kit accessories
- > Pushbuttons and switches with a vibrant color pallet

#### A touch of style for your electrical panels

- > Innovative design without compromise on cost
- > Better perceived quality of your machines and panels
- > A clearer view of control features

#### Define your own style with powerful customization abilities

- > Markings on pushbutton, illuminated pushbuttons, and pilot lights caps
- > Markings on the bezel for all built-in flush products
- > Markings on accessories, like legend plates and legend panels





Emergency stop pushbutton with illuminated rings

#### Operational efficiency

The Harmony XB5 range offers innovative features for ease-of-use to make an operator's work simpler and more efficient.

#### Improved operator efficiency

- > Illuminated Emergency stop pushbutton solutions that help you quickly find the E-stop button responsible for the production downtime
- > Robust illuminated and non-illuminated buzzers providing water resistance up to IP66, IP67, IP69, and IP69K
- > High brightness and full-surface illumination of pushbuttons and selector switches

#### Reduce safety risk and downtime machine

- > Monitor the Emergency stop head connection with the NC safety monitoring contact block reduce human error during maintenance or installation of the machine
- > Integrated two functions in one to keep existing cabling and avoid extra connection risk



NC monitoring contact block

#### Universal LED block for all illuminated functions

Harmony streamline the structure of pilot lights and actuators using LED by moving from 6 colored LEDs to a universal source of luminosity.

#### A unique technology that leads to the best lighting solution

- > Divide by 6 the stocked part numbers (for a given wiring & voltage solution)
- > Astonishing intensity and contrast with enhanced color purity
- > Reduce conception and installation time
- > Simplified maintenance
- > Avoid errors on pairing between heads and light blocks, nomenclatures are simplified

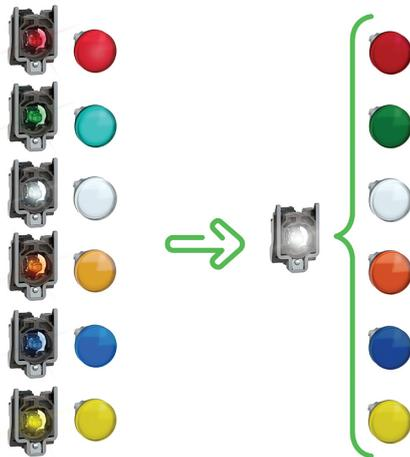

LED rationalization while ensuring the same functionality

The universal light blocks are now identifiable in the catalog with the below logo as well as physically on the product with the two letters "UN".

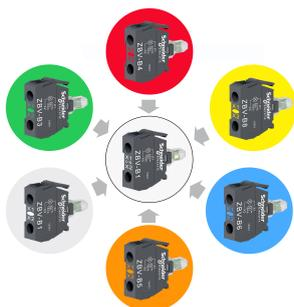



#### Affordable

Harmony delivers simplicity and efficiency while helping to keep your costs down.

#### Increasing operator's efficiency

- > USB and RJ45 ports for a simple, effective way to connect a PC or USB
- > Timer for simple adjustment of your machine's time settings
- > 3-phase pilot lights mounted in a single 30 mm (1.181 in.) diameter hole
- > Potentiometer with integrated resistor
- > Yellow illuminated functions

Small displays in a diameter 22 mm hole for quicker mounting



USB port



RJ45 port



Timer



3-phase indicator



Complete potentiometer



Buzzer



Basic display

Mounting options for easy access to functions on the front panel



Legend panel

#### Legend panels that help simplify installation

- > Holes positions are clearly identified and aligned on the legend panels
- > Just stick the legend panel on your operator interface surface and punch the hole where indicated
- > Save up to 75% of installation time compared with conventional hole alignment methods

#### Compatible with control stations and enclosures

The Harmony XB5 range is compatible with a wide range of control stations and enclosures

- > XALD/K: standard/yellow plastic box for XB5
- > XALG: for chemical application and/or IP69K solution
- > XALF: dedicated for lift application with XB5 or XB7
- > XAPA: polyster resin for outdoor or chemical application
- > XAPD: standard metal grey box (RAL7035)



## Product Selector

Web digital selector  
Click to open the selector



Digi-Cat  
Click to download Digi-Cat

### Simple selection

Harmony XB5 delivers a comprehensive range of modular products that enable simple selection to help minimize your costs right from the beginning.

### Digital tools help you select the right product and customize it to meet your needs

- > Digi-Cat, for easy, up-to-date, access to the PDF catalogs
- > Web digital selector to help you find the right reference for your application and customize your product

### Easy to convert from standard to flush mounted pushbuttons

- > Harmony XB5 pushbuttons offer the flexibility to convert from standard to flush mounting versions by simply changing a single letter in the product reference.

Example:

ZB5AA3



Standard  
mounting

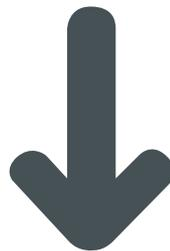

ZB5FA3



Flush  
mounting

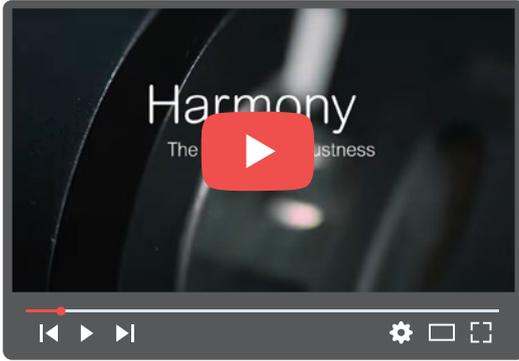

The secret of robustness  
Click to open video (46 sec)

### Robustness

Harmony XB5 delivers extremely robust performance even in severe environments.

#### Improved reliability of panels, machines, and processes

- > Sealing effectiveness rated up to IP66, IP67, IP68, IP69, IP69K, and type 4X
- > High impact resistance up to IK06 rating
- > Operating temperature ranging from -40 to +70 °C / -40 to +158 °F
- > Compliance with international standards (IEC, UL, CCC, EAC, JIS)
- > Marine certified (BV, LROS, BDNV, GL)

**IP69**

Robust performance  
even in harsh  
environments

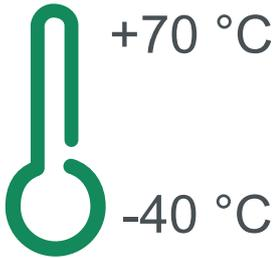

#### High electrical performance

- > Contacts and heads designed to prevent vibration, helping to ensure secure mounting and wiring
- Choose from standard, low-load, and high-power electrical contacts

#### Lower maintenance

- > Harmony pushbuttons are designed to perform up to 10 million operations.
- This represents more than 1,000 operations a day for 27 years



Marine environment  
Click to open video (42 sec)

## Adapted to your applications, segments, and operating environments

Harmony offers a unique and unrivalled depth of range delivering products adapted to your applications, segments, and operating environments.



Material working



Packaging



Pumping



Consumer packaged goods



Water & waste water



Oil & Gas



Material handling

# Control and signaling units

## Harmony XB5, plastic

### Pushbuttons, switches, and pilot lights



Harmony XB5 range of control and signaling units for Ø 22 mm/0.866 in. mounting



Harmony XB5 flush mounted control and signaling units for Ø 30 mm/1.181 in mounting



Harmony Digital Panel meter

### Presentation

The Harmony XB5 plastic range of modular control and signaling units combines simplicity of installation, flexibility, and robustness. It meets the requirements of the majority of industrial applications. These units are either complete products or separate components for customer assembly.

This range includes:

- Pushbuttons, selector/key switches, Emergency stop functions, and multiple-headed pushbuttons designed for parameter settings, adjustments, and start/stop control of machines and installations
- Pilot lights, illuminated pushbuttons, illuminated selector switches, and illuminated Emergency stop functions designed for visual signaling
- Flush mounting heads for Ø 30 mm/1.181 in. mounting and flush mounting kit accessories combined to offer a modern look to the control panel
- Harmony basic and configurable display offers data visualization
- Various accessories including protective covers, legends and legend holders, pushbutton caps, boots, bulbs, etc.

The pushbutton and switch control offer (illuminated and non-illuminated) is both broad and comprehensive:

- Pushbuttons, spring return with flush push, projecting push, recessed push, booted flush push, or mushroom head
- Emergency stop pushbuttons with three types of head: push-pull, turn to release, and key release
- Pilot lights and illuminated pushbuttons with universal LED and BA 9s base fitting bulbs
- Selector switches with different types of operator: standard handle, long handle, knurled knob, or key
- Choice of heads: circular, rectangular, double-head/triple-head rectangular, or toggle
- Colors of push: white, black, green, orange, blue, red, or yellow
- Connection type: screw clamp connector, faston connector, spring terminal, or for printed circuit board
- Contact blocks for general purpose or specific applications (low current, standard or high-power switching)
- Choice of heads to meet the majority of industrial needs, from the most basic pushbuttons and pilot lights, to functions meeting modern machine requirements, such as USB & RJ45 ports
- Wide choice of accessories and spare parts
- Configurable display for simple machine function
- Other specific functions: complete potentiometer, hour counters, annunciator, or joystick controllers

Innovative complementary offers are also available:

- Control and signaling units for severe applications
- Wireless and batteryless pushbuttons
- Biometric switches

### Basic display: Harmony Digital Panel meter

Harmony XBH is a digital panel meter for mounting on a control panel or directly on the front of a machine. With the simple 4-digit display, it is easy to view process data from long distances. The display is easy to mount directly in a Ø 22 mm/0.866 in. hole and is supplied directly from the measuring loop. It has 2 digital outputs for setting a high and low limit and can be configured using the blue and red buttons on the side of the housing. An external alarm can be connected to the panel meter for providing an additional alert in the event of reaching a high or low limit threshold. Harmony XBH panel meters have an IP65 protection rating and the operating temperature can be between -20 and 60 °C/-4 and 140 °F.

The following settings can be adjusted using the configuration buttons:

- Minimum and maximum value of the input signal
- Number of decimals
- Number of measurements per second
- LOW limit and HIGH limit output threshold
- LOW limit and HIGH limit hysteresis and time delay
- Password protection for the configuration

## Control and signaling units

### Harmony XB5, plastic

#### Pushbuttons, switches, and pilot lights

#### Installation

Harmony XB5 products are both simple and quick to install:

- Mounting by single installer (self-maintaining head in its cut-out)
- Clip-together component system (head, body, contact blocks, and LED)
- Anti-loosening system for screw clamp terminals on contact blocks

Harmony XB5 standard mounting products are installed with or without a notch in a  $\text{Ø} 22 \text{ mm}/0.866 \text{ in.}$  hole, thanks to the self-cleavable orientation pin.



*For installation of Harmony XB5 standard mounting products*



*For installation of Harmony XB5 flush mounting products*

Harmony XB5 flush mounting products are installed without a notch in a  $\text{Ø} 30 \text{ mm}/1.181 \text{ in.}$  hole. This gives flush mounting products the same actuating area as that of standard mounting products, offering optimized ergonomics for operators even when wearing gloves.

Flush solutions mounted in a  $\text{Ø} 22 \text{ mm}/0.866 \text{ in.}$  hole can be achieved using the Harmony XB6 range. Please refer to the Harmony XB6 catalog for details.

#### Environment

The performance of the Harmony XB5 range meets some of the most demanding international standards and approvals:

- Certified and approved for meeting requirements worldwide: EN/IEC, CE marking, UL, CSA, CCC, EAC, JIS, NEMA, and marine approvals
- Protection against the ingress of solid foreign objects, dust, and water: IP66, 67, 69, 69K, type 4X
- Operating temperature range from  $-40 \text{ °C}$  to  $+70 \text{ °C}/-40 \text{ °F}$  to  $+158 \text{ °F}$  for outdoor applications
- High chemical robustness
- Shock protection level up to IK03
- High vibration resistance with shakeproof connection screws (periodic retightening unnecessary)

Product type	Pilot lights	Pushbuttons, selector switches, and pilot lights			Biometric switches	
						
<b>Description of range</b>	<ul style="list-style-type: none"> <li>LED pilot lights</li> </ul>	<ul style="list-style-type: none"> <li>Pushbuttons</li> <li>Multiple-headed pushbuttons</li> <li>Emergency Stop pushbuttons</li> <li>Selector switches and key switches</li> <li>Illuminated pushbuttons</li> <li>Pilot lights</li> <li>Flush mounted pushbuttons, selector switches, and pilot lights (1)</li> </ul>			<ul style="list-style-type: none"> <li>Fingerprint readers 24V ~</li> <li>Stand-alone biometric switches</li> <li>Stand-alone USB biometric switches</li> <li>USB biometric switches dedicated to Schneider HMI (2)</li> </ul>	
<b>Features</b>	<b>Products</b>	Monolithic, compact, low consumption	Complete units or sub-assemblies (body + head)			Monolithic
	<b>Bezel</b>	Double insulated	Double insulated (4)	Metal, chromium plated, or black	Double insulated	Double insulated, dark gray
	<b>Shape of head</b>	Circular	Circular, square, or rectangular	Circular	Circular or square	–
<b>Drilling or cut-out for fixing</b>		Ø 8 mm and Ø 12 mm/0.315 in. and 0.472 in.	Ø 16 mm/0.630 in.	Ø 22 mm/0.866 in. Ø 30 mm/1.181 in. (for flush mounted control and signaling units)	Ø 22 mm/0.866 in.	
<b>Degree of protection</b>	Conforming to IEC 60529	IP40 IP65 with seal	IP65	IP66, IP67, IP69, and IP69K	IP65 (control button)	
	Conforming to UL 508 and CSA C22-2 No. 14	–	Enclosure type 4, 4X, and 13			Enclosure type 12
<b>Cabling</b>		Tags for 2.8 x 0.5 mm/0.110 x 0.020 in. connectors or threaded connector	Faston connectors Solder pins for printed circuit boards (4) Fast connector socket (5)	Spring clamp terminal connections Screw clamp terminal connections Faston connectors Connector with adapter for printed circuit board	Cable or connectors	
<b>Mounting</b>	Panel thickness	1...8 mm/0.039...0.315 in.	1...6 mm/0.039...0.236 in.			
<b>Type references</b>		<b>XVLA</b>	<b>XB6, XB6E</b>	<b>XB4</b>	<b>XB5</b>	<b>XB5S</b>

(1) Flush mounted control and signaling units are available for Harmony XB4 and XB5 ranges only.  
 (2) Compatible with Magelis iPC, STU, OT, GXO, GT (except GT1000 series), GK, GH, and GTO models.  
 (3) Wireless and batteryless pushbutton and receiver ready-paired at the factory.

Wireless and batteryless pushbuttons	Pushbuttons, selector switches, and pilot lights	Joystick controllers	Pushbuttons, selector switches, and pilot lights	Cam switches
				
<ul style="list-style-type: none"> <li>Wireless and batteryless pushbuttons and rope pull switch</li> <li>Wireless receivers</li> <li>Harmony Hub</li> </ul>	<ul style="list-style-type: none"> <li>Pushbuttons</li> <li>Emergency Stop and Emergency switching off pushbuttons</li> <li>Selector switches and key switches</li> <li>Illuminated pushbuttons</li> <li>Pilot lights</li> </ul>	<ul style="list-style-type: none"> <li>2- or 4-direction</li> <li>Stay put or spring return</li> </ul>	<ul style="list-style-type: none"> <li>Pushbuttons</li> <li>Emergency Stop pushbuttons</li> <li>Selector switches and key switches</li> <li>Illuminated pushbuttons</li> <li>Pilot lights</li> </ul>	<ul style="list-style-type: none"> <li>Switches</li> <li>Stepping switches</li> <li>Reversing and changeover switches</li> <li>Ammeter switches</li> <li>Voltmeter switches</li> <li>Reversing switches</li> <li>Star-delta and reversing star-delta switches</li> <li>Pole change switches</li> </ul>
Ready-to-use packs (3) and "components" range	Monolithic	Complete units or sub-assemblies (body + head with lever)	Complete units or sub-assemblies (body + head)	Complete units or sub-assemblies (body + front panel+ head)
Metal, chromium plated, or double insulated, black	Double insulated, dark gray (or white for pilot lights)	Metal, chromium plated	Double insulated, black	Metal, chromium plated, or double insulated, black
Transmitter with circular head	Circular	Circular	Hexagonal	Square
Ø 22 mm/0.866 in.			Ø 30 mm/1.181 in.	Ø 16 or Ø 22 mm/0.630 or 0.866 in.: series K10 Ø 22 mm/0.866 in. and multifixing: series K1/K2 4 holes, 48 or 68 centers: series K30...K150
IP65	IP65 (control buttons and pilot lights) IP54 (Emergency switching off pushbuttons)	IP65	IP66	IP65: series K10 IP40, IP65 with seal: series K1/K2 IP40: series K30...K150
Enclosure type 12	Enclosure type 3 (pushbuttons and Emergency stop) and 4 (pilot lights)	Enclosure type 4, 4X and 13	Enclosure type 4 and 13 (9001K) Enclosure type 4, 4X, 13 (9001SK)	–
Wireless (transmitter) Through cable (receiver)	Screw and captive clamp terminal connections Faston clip connections (pilot lights)	Screw and captive clamp terminal connections		
1...6 mm/0.039...0.236 in.				0.5...6 mm/0.020...0.236 in. (depending on model)
<b>XB5R, XB4R</b>	<b>XB7</b>	<b>XD4PA</b>	<b>XD2GA</b>	<b>XD5PA</b>
			<b>9001K, 9001SK</b>	<b>K10, K1, K2, K30, K50, K63, K115, K150</b>

(4) For Harmony XB6 only.  
 (5) For Harmony XB6E only.

# Control and signaling units

Harmony XB5, plastic

Diameter 22 mm Pushbuttons, switches, and pilot lights

Complete units, XB5A

**Complete units**

**Contact functions**

<b>Pushbuttons, spring return</b>			
	Flush push, unmarked XB5AA●1/AA42 see <a href="#">page 29</a>	Flush push, marked XB5AA3311/AA33●1 see <a href="#">page 32</a>	Projecting push, marked XB5AL4322 see <a href="#">page 32</a>

<b>Pushbuttons, spring return</b>			
	Booted flush push XB5AP●1/AP42 see <a href="#">page 31</a>	Projecting push, unmarked XB5AL42 see <a href="#">page 30</a>	Ø 40/1.575 in. Mushroom head XB5AC21 see <a href="#">page 39</a>

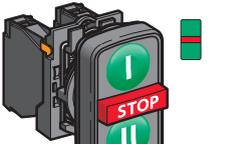
<b>Multiple-headed pushbuttons, spring return</b>		
	Double-headed XB5AL73415 see <a href="#">page 37</a>	Triple-headed XB5AA731327/XB5AA711237 see <a href="#">page 38</a>

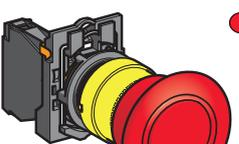
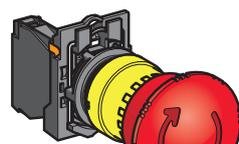
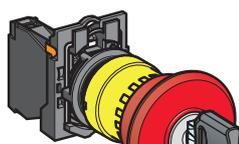
<b>Emergency stop or Emergency switching off mushroom head pushbuttons</b>			
	Emergency stop trigger action and mechanical latching Ø 40/1.575 in. Push-pull (EN/ISO 13850) XB5AT845 see <a href="#">page 41</a>	Ø 40/1.575 in. Turn to release (EN/ISO 13850) XB5AS844● see <a href="#">page 41</a>	Ø 40/1.575 in. Key release (EN/ISO 13850) XB5AS9445 see <a href="#">page 41</a>

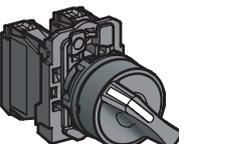
<b>Selector switches and key switches</b>			
	Standard handle, black XB5AD●● see <a href="#">page 54</a>	Long handle, black XB5AJ●● see <a href="#">page 55</a>	Key switch XB5AG●● see <a href="#">page 56</a>

# Control and signaling units

Harmony XB5, plastic

Diameter 22 mm Pushbuttons, switches, and pilot lights

Complete units, XB5A

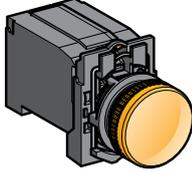
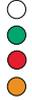
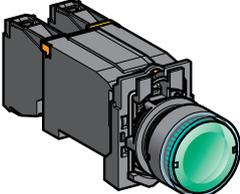
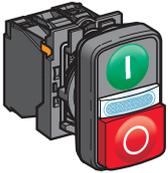
Complete units (continued)	Signaling functions		
Pilot lights	 	 	 
	Universal LED XB5AVB●/AVG●/AVM● see <a href="#">page 60</a>	For bulb with BA 9s base fitting Direct supply XB5AV6● see <a href="#">page 62</a>	Via integral transformer XB5AV3●/AV4● see <a href="#">page 62</a>
Combined functions	Contact and signaling functions		
Illuminated pushbuttons, spring return, flush push	 	 	 
	Universal LED XB5AW3●B5/AW3●G5/AW3●M5 see <a href="#">page 33</a>	For bulb with BA 9s base fitting Direct supply XB5AW3●65 see <a href="#">page 36</a>	Via integral transformer XB5AW3●35/AW3●45 see <a href="#">page 36</a>
Double-headed pushbuttons, spring return, and pilot light block	 	Universal LED XB5AW73731●5 see <a href="#">page 37</a>	
Illuminated selector switches, standard handle	 	Universal LED XB5AK12●●5, XB5AK13●●5 see <a href="#">page 58</a>	

# Control and signaling units

Harmony XB5, plastic

Diameter 22 mm Pushbuttons, switches, and pilot lights

Sub-assemblies, ZB5A

## Non-illuminated units for user assembly

For pushbuttons, spring return, unmarked



Screw clamp terminals  
ZB5AZ10●/AZ141  
see [page 101](#)



Faston  
ZB5AZ10●3  
see [page 107](#)

For pushbuttons, spring return, marked

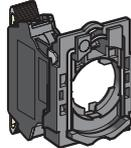

Spring clamp terminals  
ZBE10●5  
ZB5AZ10●5  
see [page 104](#)

For multiple-headed pushbuttons, spring return

For "push-push to release" pushbuttons

For "push-turn to release" pushbuttons

## Contact functions

### Body sub-assemblies

### Head sub-assemblies

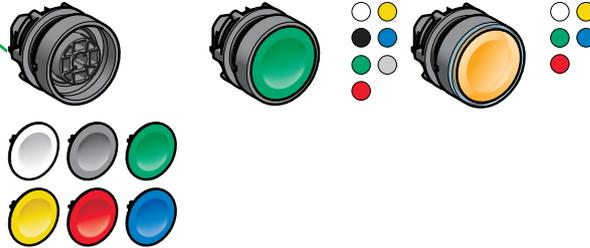

Flush push without cap/with set of 6 caps  
ZB5AA0/AA9  
see [page 29](#)

Flush push  
ZB5AA●  
see [page 29](#)

Flush push for insertion of legend  
ZB5AA●8  
see [page 29](#)



Projecting  
ZB5AL●  
see [page 30](#)



Recessed push  
ZB5AA●6  
see [page 30](#)



Booted flush push, for insertion of legend  
ZB5AP●●/AP●S  
see [page 31](#)



Flush push  
ZB5AA●3●/AA●4●  
see [page 32](#)



Projecting push  
ZB5AL●3●  
see [page 32](#)



Double-headed  
ZB5AA7●●●/AA79  
ZB5AL734●  
see [page 37](#)



Triple-headed  
ZB5AA7313●, ZB5AA711●●  
ZB5AA72124, ZB5AA791  
see [page 38](#)



Flush push (caps mounted/not mounted)  
ZB5AH●●/CH●●  
see [page 52](#)



Projecting push  
ZB5AH●  
see [page 52](#)



Knurled knob (1)  
ZB5AF  
see [page 53](#)

(1) Knob positions

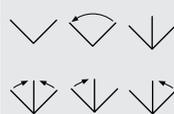



# Control and signaling units

Harmony XB5, plastic

Diameter 22 mm Pushbuttons, switches, and pilot lights

Sub-assemblies, ZB5A

## Pilot lights for user assembly

### Signaling functions

#### Body sub-assemblies with Universal LED



**UN**  
Universal  
for all color heads

Connection: screw clamp terminals  
ZB5AVB●/AVG●/AVM●  
see [page 109](#)



**UN**  
Universal  
for all color heads

Connection: plug-in connector  
Please contact our Customer Care Center

#### Head sub-assemblies



With lens fitted (insertion of legend)  
ZB5AV0●3/AV0●3E, see [page 61](#)

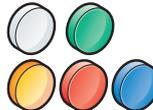

With 5 lens caps (not fitted) for insertion of legend  
ZB5AV003/AV0●3●, see [page 61](#)

#### Body sub-assemblies for BA 9s bulb



Direct supply  
Connection: screw clamp terminals  
ZB5AV6, see [page 111](#)

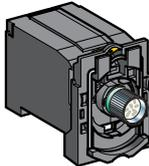

Via integral transformer  
Connection: screw clamp terminals  
ZB5AV●/AV3D●/AV5D●  
see [page 111](#)

#### Head sub-assemblies



With lens fitted  
ZB5AV0●, see [page 62](#)

## Illuminated pushbuttons for user assembly

### Combined functions (contact and signaling)

#### Body sub-assemblies for BA 9s bulb



Direct supply  
Connection: screw clamp terminals  
ZB5AW06●  
see [page 109](#)

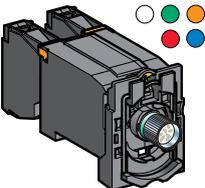

Via integral transformer  
Connection: screw clamp terminals  
ZB5AW03●/AW04●/AW05●  
see [page 110](#)

#### Head sub-assemblies



Flush  
ZB5AW3●/AW3●S  
see [page 36](#)



Projecting  
ZB5AW1●/AW1●S,  
see [page 36](#)

For illuminated pushbuttons, spring return

# Control and signaling units

Harmony XB5, plastic

Diameter 22 mm Pushbuttons, switches, and pilot lights

Sub-assemblies, ZB5A

## Illuminated pushbuttons for user assembly

For illuminated pushbuttons, spring return

## Combined functions (contact and signaling) (continued)

### Body sub-assemblies with Universal LED



Connection: screw clamp terminals  
**ZB5AW0B●●/AW0G●●/AW0M●●**  
 see [page 108](#)



Connection: plug-in connector  
 Please contact our Customer Care Center

For double-headed pushbuttons, spring return, with pilot light



Connection: spring clamp terminals  
**ZBV ●●5**  
 see [page 105](#)

For illuminated, mushroom head pushbuttons, latching

For illuminated mushroom head pushbuttons

- Emergency stop with trigger action and mechanical latching

or

- Emergency switching off with mechanical latching only

For illuminated "push-push to release" pushbuttons

For illuminated selector switches, standard handle

### Head sub-assemblies



Flush push with illuminated ring  
**ZB5AW3●3/AW3●3S/AW9●3**  
 see [page 34](#)

Flush push for insertion of legend  
**ZB5AA●8**  
 see [page 29](#)

Booted flush push  
**ZB5AW5●3**  
 see [page 34](#)

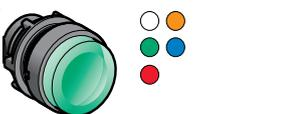

Projecting push  
**ZB5AW1●3/AW1●3S**  
 see [page 35](#)



Double-headed (flush/flush push) + central pilot light  
 Double-headed (flush/projecting push) + central pilot light  
**ZB5AW7A17●●, ZB5AW7A374●, ZB5AW7A9, see page 37**  
**ZB5AW7L374●, see page 37**

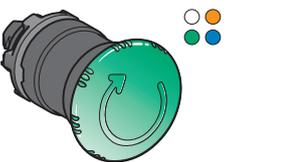

Ø 40 mm/1.575 in. turn to release  
**ZB5AW7●3, see page 40**

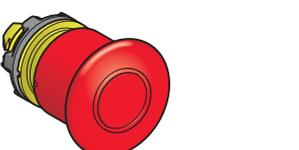

Ø 40 mm/1.575 in. push-pull with mechanical state indicator (EN/ISO 13850)  
**ZB5AT8643M**  
 see [page 44](#)



Ø 40 mm/1.575 in. turn to release (IEC 60364-5-53)  
**ZB5AW743**  
 see [page 44](#)

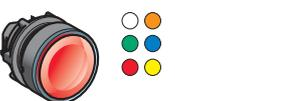

Flush or projecting "push-push to release"  
**ZB5AH0●3/AH●3**  
 see [page 52](#)



Standard handle (1)  
**ZB5AK1●●3**  
 see [page 59](#)

(1) Handle positions



# Control and signaling units

Harmony XB5, plastic

Diameter 22 mm Pushbuttons, switches, and pilot lights

Sub-assemblies, ZB5F Flush mounting heads

## Non-illuminated units for user assembly

## Contact functions for Ø 30 mm mounting

### Body sub-assemblies

### Head sub-assemblies

For pushbuttons, spring return, unmarked



### Screw clamp terminals

ZB5AZ10●/AZ141  
see [page 101](#)

### Flush push without cap/with set of 6 caps

ZB5FA0/FA9  
see [page 79](#)

### Flush push

ZB5FA●  
see [page 79](#)

### Flush push for insertion of legend

ZB5FA●8  
see [page 79](#)



Faston  
ZB5AZ10●3  
see [page 105](#)

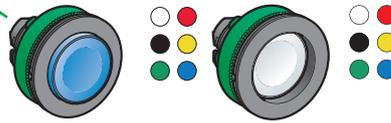

### Projecting

ZB5FL●  
see [page 80](#)

### Recessed push

ZB5FA●  
see [page 79](#)

For pushbuttons, spring return, marked

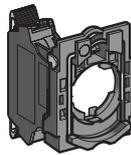

Spring clamp terminals  
ZBE10●5  
ZB5AZ10●5  
see [page 104](#)

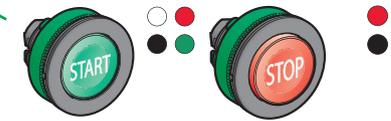

### Flush push

ZB5FA●3●/FA●4●  
see [page 81](#)

### Projecting push

ZB5FL●3●  
see [page 81](#)

For "push-push to release" pushbuttons

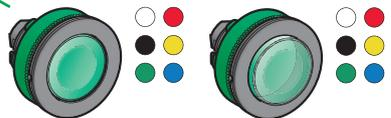

### Flush push (caps mounted/not mounted)

ZB5FH●●  
see [page 85](#)

### Projecting push

ZB5FH●  
see [page 85](#)

# Control and signaling units

Harmony XB5, plastic

Diameter 22 mm Pushbuttons, switches, and pilot lights

Sub-assemblies, ZB5F Flush mounting heads

**Non-illuminated units for user assembly**  
(continued)

**Contact functions for Ø 30 mm mounting (continued)**

**Body sub-assemblies**      **Head sub-assemblies**

**For selector switches and key switches**



Spring clamp terminals  
ZBE10●5  
ZB5AZ10●5  
see [page 104](#)



Faston  
ZB5AZ10●3  
see [page 107](#)



Standard handle (1)  
ZB5FD●  
see [page 87](#)



Long black handle (1)  
ZB5FJ●  
see [page 88](#)



Knurled black knob (1)  
ZB5FD●9  
see [page 90](#)



Key switch (2)  
ZB5FG●●  
see [page 89](#)

(1) Switch handle and knob positions

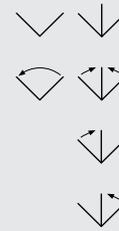

(2) Key switch positions  
⌘ Key withdrawal positions

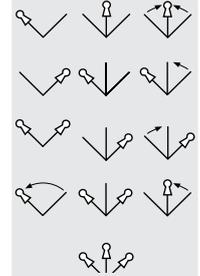

# Control and signaling units

Harmony XB5, plastic

Diameter 22 mm Pushbuttons, switches, and pilot lights

Sub-assemblies, ZB5F Flush mounting heads

**Pilot lights for user assembly**

**Signaling functions for Ø 30 mm mounting**

Body sub-assemblies with Universal LED

Head sub-assemblies



**UN**  
Universal  
for all color heads

Connection: screw clamp terminals

ZB5AVB●/AVG●/AVM●  
see [page 109](#)



With lens fitted (insertion of legend)

ZB5FV0●3  
see [page 93](#)



**UN**  
Universal  
for all color heads

Connection: plug-in connector

Please contact our Customer Care Center

# Control and signaling units

Harmony XB5, plastic

Diameter 22 mm Pushbuttons, switches, and pilot lights

Sub-assemblies, ZB5F Flush mounting heads

## Illuminated pushbuttons for user assembly

## Combined functions (contact and signaling)

Body sub-assemblies with Universal LED

Head sub-assemblies

For illuminated pushbuttons, spring return



UN  
Universal  
for all color heads

Connection: screw clamp terminals

ZB5AW0B●●/AW0G●●/  
AW0M●●  
see [page 108](#)

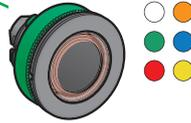

Flush push with illuminated ring

ZB5FW9●3  
see [page 83](#)

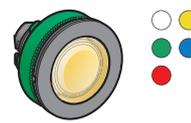

Flush push for insertion of legend

ZB5FA●8  
see [page 79](#)



UN  
Universal  
for all color heads

Connection: plug-in connector

Please contact our  
Customer Care Center

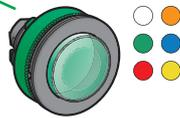

Projecting push

ZB5FW1●3  
see [page 84](#)



UN  
Universal  
for all color heads

Connection: spring clamp terminals

ZBV●●5  
see [page 105](#)

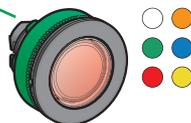

Flush or projecting "push-push to release"

ZB5FH0●3/FH●3  
see [page 86](#)

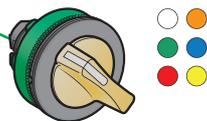

Standard handle (1)

ZB5FK1●●3  
see [page 91](#)

(1) Handle positions





# Harmony XB5, Plastic For Ø 22 mm mounting

## Control and signaling units

Harmony XB5, plastic

Diameter 22 mm, spring return pushbuttons, unmarked

Pushbuttons with flush push <sup>(1)</sup>							
Screw clamp terminal connections (Schneider Electric anti-loosening system)							
Shape of head	Type of push	Type of contact		Color of push	Reference		Weight kg/lb
		NO	NC		For black bezel	For gray bezel <sup>(2)</sup>	
<b>Complete units <sup>(3)</sup></b>							
	Flush	1	–	White	<b>XB5AA11</b> (ZB5AZ101 + ZB5AA1)	<b>XB5AA11C0</b> (ZB5AZ101 + ZB5AA1C0)	0.037/0.082
				Black	<b>XB5AA21</b> (6) (ZB5AZ101 + ZB5AA2)	<b>XB5AA21C0</b> (ZB5AZ101 + ZB5AA2C0)	0.037/0.082
				Green	<b>XB5AA31</b> (7) (ZB5AZ101 + ZB5AA3)	<b>XB5AA31C0</b> (ZB5AZ101 + ZB5AA3C0)	0.037/0.082
				Yellow	<b>XB5AA51</b> (ZB5AZ101 + ZB5AA5)	<b>XB5AA51C0</b> (ZB5AZ101 + ZB5AA5C0)	0.037/0.082
				Blue	<b>XB5AA61</b> (ZB5AZ101 + ZB5AA6)	<b>XB5AA61C0</b> (ZB5AZ101 + ZB5AA6C0)	0.037/0.082
						Red	<b>XB5AA42</b> (6) (ZB5AZ102 + ZB5AA4)

XB5AA31

XB5AA51C0

<b>Heads only, circular <sup>(3)</sup></b>							
	Without cap <sup>(4)</sup>	–		<b>ZB5AA0</b>	–		0.022/0.049
	Flush, with set of 6 colored caps		6 colors <sup>(4)</sup>	<b>ZB5AA9</b>	–		0.027/0.060
	Flush			White	<b>ZB5AA1</b>	<b>ZB5AA1C0</b>	0.018/0.040
				Black	<b>ZB5AA2</b>	<b>ZB5AA2C0</b>	0.018/0.040
				Green	<b>ZB5AA3</b>	<b>ZB5AA3C0</b>	0.018/0.040
				Red	<b>ZB5AA4</b>	<b>ZB5AA4C0</b>	0.018/0.040
				Yellow	<b>ZB5AA5</b>	<b>ZB5AA5C0</b>	0.018/0.040
				Blue	<b>ZB5AA6</b>	<b>ZB5AA6C0</b>	0.018/0.040
				Gray	<b>ZB5AA8</b>	<b>ZB5AA8C0</b>	0.018/0.040
	Flush with transparent cap for insertion of legend <sup>(5)</sup>			White	<b>ZB5AA18</b>	<b>ZB5AA18C0</b>	0.018/0.040
				Green	<b>ZB5AA38</b>	<b>ZB5AA38C0</b>	0.018/0.040
				Red	<b>ZB5AA48</b>	<b>ZB5AA48C0</b>	0.018/0.040
				Orange	<b>ZB5AA58</b>	<b>ZB5AA58C0</b>	0.018/0.040
				Blue	<b>ZB5AA68</b>	<b>ZB5AA68C0</b>	0.018/0.040
	illuminated flush pushbutton head, with set of 6 colored caps		6 colors	<b>ZB5AA98</b>	–		0.018/0.040

ZB5AA5

ZB5AA48

(1) For recommended maximum number of contacts constituting the body (fixing collar and contact) associated with the head, see [page 26 and 27](#).

(2) To add customized markings on these references using the web customization tool, see [page 5](#).

(3) Colored cap to be ordered separately, see [page 68](#).

(4) Head supplied with 6 different colored caps (white, black, green, red, yellow, or blue) not fitted.

(5) For legend ordering information, see [page 76](#).

(6) To order products with 1NO and 1NC contact, replace the last digit of the commercial reference with a 5, example: XB5AA21 becomes XB5AA25.

# Control and signaling units

Harmony XB5, plastic

Diameter 22 mm, spring return pushbuttons, unmarked

Pushbuttons with recessed push (1)						
High guard						
Shape of head	Type of push	Color	Reference		Weight kg/lb	
			For black bezel	For gray bezel		
<b>Heads only, circular (2)</b>						
	Recessed (high guard)	White	ZB5AA16	ZB5AA16C0	0.020/0.044	
		Black	ZB5AA26	ZB5AA26C0	0.020/0.044	
		Green	ZB5AA36	ZB5AA36C0	0.020/0.044	
		Red	ZB5AA46	ZB5AA46C0	0.020/0.044	
		Yellow	ZB5AA56	ZB5AA56C0	0.020/0.044	
		Blue	ZB5AA66	ZB5AA66C0	0.020/0.044	



ZB5AA16



ZB5AA46C0

Pushbuttons with projecting push (1)							
Screw clamp terminal connections (Schneider Electric anti-loosening system)							
Shape of head	Type of push	Type of contact		Color of push	Reference		Weight kg/lb
		NO	NC		For black bezel	For gray bezel	
<b>Complete units (2)</b>							
	Projecting	–	1	Red	ZB5AL42 (ZB5AZ102 + ZB5AL4)	ZB5AL42C0 (ZB5AZ102 + ZB5AL4C0)	0.038/0.084
		<b>Heads only, circular (2)</b>					
	Projecting			White	ZB5AL1	ZB5AL1C0	0.019/0.042
				Black	ZB5AL2	ZB5AL2C0	0.019/0.042
				Green	ZB5AL3	ZB5AL3C0	0.019/0.042
				Red	ZB5AL4	ZB5AL4C0	0.019/0.042
				Yellow	ZB5AL5	ZB5AL5C0	0.019/0.042
				Blue	ZB5AL6	ZB5AL6C0	0.019/0.042



XB5AL42



XB5AL42C0



ZB5AL3



ZB5AL6C0

(1) For recommended maximum number of contacts constituting the body (fixing collar and contact) associated with the head, see page 26 and 27.

(2) To add customized markings on these references using the web customization tool, see page 5.

## Control and signaling units

Harmony XB5, plastic

Diameter 22 mm, spring return pushbuttons, unmarked



XB5AP51



XB5AP61C0



ZB5AP4



ZB5AP2S



ZB5AP383

## Pushbuttons with booted head (1)

Screw clamp terminal connections (Schneider Electric anti-loosening system)

Shape of head	Type of push	Type of contact		Color of push	Reference		Weight kg/lb
		NO	NC		For black bezel	For gray bezel	

## Complete units (2)

	Booted, clear silicone (color of push unobscured)	1	–	Black	<a href="#">XB5AP21</a> ( <a href="#">ZB5AZ101</a> + <a href="#">ZB5AP2</a> )	<a href="#">XB5AP21C0</a>	0.039/0.086
				Green	<a href="#">XB5AP31</a> ( <a href="#">ZB5AZ101</a> + <a href="#">ZB5AP3</a> )	<a href="#">XB5AP31C0</a>	0.039/0.086
				Yellow	<a href="#">XB5AP51</a> ( <a href="#">ZB5AZ101</a> + <a href="#">ZB5AP5</a> )	<a href="#">XB5AP51C0</a>	0.039/0.086
				Blue	<a href="#">XB5AP61</a> ( <a href="#">ZB5AZ101</a> + <a href="#">ZB5AP6</a> )	<a href="#">XB5AP61C0</a>	0.039/0.086
		–	1	Red	<a href="#">XB5AP42</a> ( <a href="#">ZB5AZ102</a> + <a href="#">ZB5AP4</a> )	–	0.039/0.086

## Silicone booted heads only, with increased protection (IP69K)

	Flush	Clear boot (3) For insertion of protected legend within head (4)	White	<a href="#">ZB5AP18</a> (2)	–	0.023/0.051
			Green	<a href="#">ZB5AP38</a>	–	0.023/0.051
			Red	<a href="#">ZB5AP48</a> (2)	–	0.023/0.051
			Yellow	<a href="#">ZB5AP58</a>	–	0.023/0.051
			Blue	<a href="#">ZB5AP68</a> (2)	–	0.023/0.051
	Projecting	Clear boot (2)(3)	White	<a href="#">ZB5AP1</a>	–	0.014/0.031
			Black	<a href="#">ZB5AP2</a>	–	0.014/0.031
			Green	<a href="#">ZB5AP3</a>	–	0.014/0.031
			Red	<a href="#">ZB5AP4</a>	–	0.014/0.031
			Yellow	<a href="#">ZB5AP5</a>	–	0.014/0.031
			Blue	<a href="#">ZB5AP6</a>	–	0.014/0.031

## Silicone booted heads only, standard for mouting with legend holder (IP66)

	Flush	Colored boot (2)(5)	White	<a href="#">ZB5AP1S</a>	–	0.021/0.046
			Black	<a href="#">ZB5AP2S</a>	–	0.021/0.046
			Green	<a href="#">ZB5AP3S</a>	–	0.021/0.046
			Red	<a href="#">ZB5AP4S</a>	–	0.021/0.046
			Yellow	<a href="#">ZB5AP5S</a>	–	0.021/0.046
			Blue	<a href="#">ZB5AP6S</a>	–	0.021/0.046
	Flush	Clear membrane (5) For insertion of protected legend within head (4)	White	<a href="#">ZB5AP183</a>	–	0.010/0.022
			Green	<a href="#">ZB5AP383</a>	–	0.010/0.022
			Red	<a href="#">ZB5AP483</a>	–	0.010/0.022
			Yellow	<a href="#">ZB5AP583</a> (2)	–	0.010/0.022
			Blue	<a href="#">ZB5AP683</a>	–	0.010/0.022

(1) For recommended maximum number of contacts constituting the body (fixing collar and contact) associated with the head, see [page 26](#) and [page 27](#).(2) To add customized markings on these references using the web customization tool, see [page 5](#).

(3) Permissible panel thickness 1 to 5 mm/0.039 to 0.197 in., cannot be used with legend holders.

(4) To order a legend for insertion within the head, see [page 76](#).(5) For replacement of silicone protection element without dismantling head, see [page 70](#).

# Control and signaling units

Harmony XB5, plastic

Diameter 22 mm, spring return pushbuttons, with marking

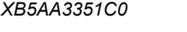
Pushbuttons with flush or projecting push <sup>(1)</sup>								
Screw clamp terminal connections (Schneider Electric anti-loosening system)								
Shape of head	Type of push	Type of contact		Marking Text (color)	Color of push	Reference		Weight kg/lb
		NO	NC			For black bezel	For gray bezel	
<b>Complete units <sup>(2)</sup></b>								
	Flush	1	–	"I" (white)	Green	<b>XB5AA3311</b> <b>(ZB5AZ101 + ZB5AA331)</b>	<b>XB5AA3311C0</b> <b>(ZB5AZ101 + ZB5AA331C0)</b>	0.037/0.082
	Flush	–	1	"O" (white)	Red	<b>XB5AA4322</b> <b>(ZB5AZ102 + ZB5AA432)</b>	<b>XB5AA4322C0</b> <b>(ZB5AZ102 + ZB5AA432C0)</b>	0.037/0.082
	Flush (3)	1	–	↑ (black)	White	<b>XB5AA3341</b> <b>(ZB5AZ101 + ZB5AA334)</b>	<b>XB5AA3341C0</b> <b>(ZB5AZ101 + ZB5AA334C0)</b>	0.037/0.082
	Flush (3)	1	–	↓ (white)	Black	<b>XB5AA3351</b> <b>(ZB5AZ101 + ZB5AA335)</b>	<b>XB5AA3351C0</b> <b>(ZB5AZ101 + ZB5AA335C0)</b>	0.037/0.082
<b>Heads only, circular <sup>(2)</sup></b>								
	Flush			"I" (white)	Green	<b>ZB5AA331</b>	<b>ZB5AA331C0</b>	0.018/0.040
				"I" (black)	White	<b>ZB5AA131</b>	<b>ZB5AA131C0</b>	0.018/0.040
				"II" (white)	Green	<b>ZB5AA336</b>	–	0.018/0.040
				"START" (white)	Green	<b>ZB5AA333</b>	<b>ZB5AA333C0</b>	0.018/0.040
				"ON" (white)	Green	<b>ZB5AA341</b>	–	0.018/0.040
				"MARCHE" (white)	Green	<b>ZB5AA342</b>	–	0.018/0.040
				 (white)	Black	<b>ZB5AA245</b>	–	0.018/0.040
				 (black)	White	<b>ZB5AA145</b>	–	0.018/0.040
				"O" (white)	Red	<b>ZB5AA432</b>	<b>ZB5AA432C0</b>	0.018/0.040
					Black	<b>ZB5AA232</b>	–	0.018/0.040
				"ARRET" (white)	Red	<b>ZB5AA433</b>	–	0.018/0.040
				"STOP" (white)	Red	<b>ZB5AA434</b>	<b>ZB5AA434C0</b>	0.018/0.040
					Black	<b>ZB5AA234</b>	–	0.018/0.040
				"OFF" (white)	Red	<b>ZB5AA435</b>	–	0.018/0.040
				UP (black)	White	<b>ZB5AA343</b>	–	0.018/0.040
				DOWN (white)	Black	<b>ZB5AA344</b>	–	0.018/0.040
				↑ (black) (3)	White	<b>ZB5AA334</b>	<b>ZB5AA334C0</b>	0.018/0.040
				↓ (white) (3)	Black	<b>ZB5AA335</b>	<b>ZB5AA335C0</b>	0.018/0.040
<b>Heads only, circular <sup>(2)</sup></b>								
	Projecting (3)			"O" (white)	Red	<b>ZB5AL432</b>	<b>ZB5AL432C0</b>	0.019/0.042
					Black	<b>ZB5AL232</b>	–	0.019/0.042
				"STOP" (white)	Red	<b>ZB5AL434</b>	–	0.019/0.042

(1) For recommended maximum number of contacts constituting the body (fixing collar and contact) associated with the head, see page 26 and 27.

(2) To add customized markings on these references using the web customization tool, see page 5.

(3) Product supplied with cap not clipped in, allowing orientation through 360° in 90° steps.

## Control and signaling units

Harmony XB5, plastic

Diameter 22 mm, illuminated pushbuttons, spring return, with Universal LED

## Illuminated pushbuttons with flush push (1)

Screw clamp terminal connections (Schneider Electric anti-loosening system)

Shape of head	Description	Type of contact		Supply voltage V	Color of push	Reference		Weight kg/lb	
		NO	NC			For black bezel	For gray bezel		
<b>Complete units - With plain lens</b>									
 XB5AW31B5	Universal LED	1	1	24 ~ 50/60 Hz	White	<a href="#">XB5AW31B5</a> ( <a href="#">ZB5AW0B15</a> + <a href="#">ZB5AW313</a> )	<a href="#">XB5AW31B5C0</a> ( <a href="#">ZB5AW0B15</a> + <a href="#">ZB5AW313C0</a> )	0.056/0.123	
					Green	<a href="#">XB5AW33B5</a> (3) ( <a href="#">ZB5AW0B15</a> + <a href="#">ZB5AW333</a> )	<a href="#">XB5AW33B5C0</a> ( <a href="#">ZB5AW0B15</a> + <a href="#">ZB5AW333C0</a> )	0.056/0.123	
					Red	<a href="#">XB5AW34B5</a> ( <a href="#">ZB5AW0B15</a> + <a href="#">ZB5AW343</a> )	<a href="#">XB5AW34B5C0</a> ( <a href="#">ZB5AW0B15</a> + <a href="#">ZB5AW343C0</a> )	0.056/0.123	
					Orange	<a href="#">XB5AW35B5</a> ( <a href="#">ZB5AW0B15</a> + <a href="#">ZB5AW353</a> )	<a href="#">XB5AW35B5C0</a> ( <a href="#">ZB5AW0B15</a> + <a href="#">ZB5AW353C0</a> )	0.056/0.123	
					Blue	<a href="#">XB5AW36B5</a> ( <a href="#">ZB5AW0B15</a> + <a href="#">ZB5AW363</a> )	<a href="#">XB5AW36B5C0</a> ( <a href="#">ZB5AW0B15</a> + <a href="#">ZB5AW363C0</a> )	0.056/0.123	
					110...120 ~	White	<a href="#">XB5AW31G5</a> ( <a href="#">ZB5AW0G15</a> + <a href="#">ZB5AW313</a> )	<a href="#">XB5AW31G5C0</a> ( <a href="#">ZB5AW0G15</a> + <a href="#">ZB5AW313C0</a> )	0.056/0.123
					50/60 Hz	Green	<a href="#">XB5AW33G5</a> ( <a href="#">ZB5AW0G15</a> + <a href="#">ZB5AW333</a> )	<a href="#">XB5AW33G5C0</a> ( <a href="#">ZB5AW0G15</a> + <a href="#">ZB5AW333C0</a> )	0.056/0.123
					Red	<a href="#">XB5AW34G5</a> ( <a href="#">ZB5AW0G15</a> + <a href="#">ZB5AW343</a> )	<a href="#">XB5AW34G5C0</a> ( <a href="#">ZB5AW0G15</a> + <a href="#">ZB5AW343C0</a> )	0.056/0.123	
					Orange	<a href="#">XB5AW35G5</a> ( <a href="#">ZB5AW0G15</a> + <a href="#">ZB5AW353</a> )	<a href="#">XB5AW35G5C0</a> ( <a href="#">ZB5AW0G15</a> + <a href="#">ZB5AW353C0</a> )	0.056/0.123	
					Blue	<a href="#">XB5AW36G5</a> ( <a href="#">ZB5AW0G15</a> + <a href="#">ZB5AW363</a> )	<a href="#">XB5AW36G5C0</a> ( <a href="#">ZB5AW0G15</a> + <a href="#">ZB5AW363C0</a> )	0.056/0.123	
					230...240 ~	White	<a href="#">XB5AW31M5</a> ( <a href="#">ZB5AW0M15</a> + <a href="#">ZB5AW313</a> )	<a href="#">XB5AW31M5C0</a> ( <a href="#">ZB5AW0M15</a> + <a href="#">ZB5AW313C0</a> )	0.056/0.123
					50/60 Hz	Green	<a href="#">XB5AW33M5</a> ( <a href="#">ZB5AW0M15</a> + <a href="#">ZB5AW333</a> )	<a href="#">XB5AW33M5C0</a> ( <a href="#">ZB5AW0M15</a> + <a href="#">ZB5AW333C0</a> )	0.056/0.123
Red	<a href="#">XB5AW34M5</a> ( <a href="#">ZB5AW0M15</a> + <a href="#">ZB5AW343</a> )	<a href="#">XB5AW34M5C0</a> ( <a href="#">ZB5AW0M15</a> + <a href="#">ZB5AW343C0</a> )	0.056/0.123						
Orange	<a href="#">XB5AW35M5</a> ( <a href="#">ZB5AW0M15</a> + <a href="#">ZB5AW353</a> )	<a href="#">XB5AW35M5C0</a> ( <a href="#">ZB5AW0M15</a> + <a href="#">ZB5AW353C0</a> )	0.056/0.123						
Blue	<a href="#">XB5AW36M5</a> ( <a href="#">ZB5AW0M15</a> + <a href="#">ZB5AW363</a> )	<a href="#">XB5AW36M5C0</a> ( <a href="#">ZB5AW0M15</a> + <a href="#">ZB5AW363C0</a> )	0.056/0.123						

(1) For recommended maximum number of contacts constituting the body (fixing collar and contact) associated with the head, see [page 26](#) and [27](#).(2) To add customized markings on these references using the web customization tool, see [page 5](#).

(3) To order products with 2NO contact, replace the last digit of the commercial reference with a 3.

# Control and signaling units

Harmony XB5, plastic

Diameter 22 mm, illuminated pushbuttons, spring return, with Universal LED



ZB5AW313



ZB5AW383C0



ZB5AW363

Illuminated pushbuttons with flush push (1)					
Shape of head	Type of push	Color	Reference		Weight kg/lb
			For black bezel	For gray bezel	
<b>Heads only, circular (2) - With plain lens (3)</b>					
	Flush	White	ZB5AW313	ZB5AW313C0	0.017/0.037
		Green	ZB5AW333	ZB5AW333C0	0.017/0.037
		Red	ZB5AW343	ZB5AW343C0	0.017/0.037
		Orange	ZB5AW353	ZB5AW353C0	0.017/0.037
		Yellow	ZB5AW383	ZB5AW383C0	0.017/0.037
		Blue	ZB5AW363	ZB5AW363C0	0.017/0.037
	Flush with illuminated ring	White	ZB5AW913	–	0.016/0.035
		Green	ZB5AW933	–	0.016/0.035
		Red	ZB5AW943	–	0.016/0.035
		Orange	ZB5AW953	–	0.016/0.035
		Yellow	ZB5AW983	–	0.016/0.035
		Blue	ZB5AW963	–	0.016/0.035
	Flush with clear boot (IP67)	White	ZB5AW513	ZB5AW513C0	0.019/0.042
		Green	ZB5AW533	ZB5AW533C0	0.019/0.042
		Red	ZB5AW543	ZB5AW543C0	0.019/0.042
		Orange	ZB5AW553	ZB5AW553C0	0.019/0.042
		Yellow	ZB5AW583	ZB5AW583C0	0.019/0.042
		Blue	ZB5AW563	ZB5AW563C0	0.019/0.042
	Flush for insertion of legend (4) (IP69 K)	White	ZB5AA18	ZB5AA18C0	0.018/0.040
		Green	ZB5AA38	ZB5AA38C0	0.018/0.040
		Red	ZB5AA48	ZB5AA48C0	0.018/0.040
		Orange	ZB5AA58	ZB5AA58C0	0.018/0.040
		Yellow	ZB5AA88	ZB5AA88C0	0.018/0.040
		Blue	ZB5AA68	ZB5AA68C0	0.018/0.040
Illuminated flush pushbutton head, with set of 6 colored caps		6 colors	ZB5AA98	–	0.018/0.040

Heads only, circular (2) - With grooved lens (3) (5)					
	Flush	White	ZB5AW313S	ZB5AW313SC0	0.017/0.037
		Green	ZB5AW333S	ZB5AW333SC0	0.017/0.037
		Red	ZB5AW343S	ZB5AW343SC0	0.017/0.037
		Orange	ZB5AW353S	ZB5AW353SC0	0.017/0.037
		Yellow	ZB5AW383S	ZB5AW383SC0	0.017/0.037
		Blue	ZB5AW363S	ZB5AW363SC0	0.017/0.037

(1) For recommended maximum number of contacts constituting the body (fixing collar and contact) associated with the head, see page 26 and 27.

(2) For use with bodies comprising a light source with Universal LED only.

(3) To add customized markings on these references using the web customization tool, see page 5.

(4) For legend ordering information, see page 76.

(5) For use in bright ambient light conditions (for example, outdoors in sunlight).

## Control and signaling units

Harmony XB5, plastic

Diameter 22 mm, illuminated pushbuttons, spring return, with Universal LED

Illuminated pushbuttons with projecting push <sup>(1)</sup>

Shape of head	Type of push	Color	Reference		Weight kg/lb
			For black bezel	For gray bezel	
<b>Heads only, circular <sup>(2)</sup> - With plain lens <sup>(3)</sup></b>					
	Projecting	White	ZB5AW113	ZB5AW113C0	0.018/0.040
		Green	ZB5AW133	ZB5AW133C0	0.018/0.040
		Red	ZB5AW143	ZB5AW143C0	0.018/0.040
		Orange	ZB5AW153	ZB5AW153C0	0.018/0.040
		Yellow	ZB5AW183	ZB5AW183C0	0.018/0.040
		Blue	ZB5AW163	ZB5AW163C0	0.018/0.040



ZB5AW143



ZB5AW183C0

(1) For recommended maximum number of contacts constituting the body (fixing collar and contact) associated with the head, see [page 26 and 27](#).

(2) For use with bodies comprising a light source with Universal LED only.

(3) To add customized markings on these references using the web customization tool, see [page 5](#).

# Control and signaling units

Harmony XB5, plastic

Diameter 22 mm, illuminated pushbuttons, spring return, with BA 9s base fitting



XB5AW3465



XB5AW3335



ZB5AW33



ZB5AW13

Illuminated pushbuttons with flush push <sup>(1)</sup>							
Screw clamp terminal connections (Schneider Electric anti-loosening system)							
Shape of head	Description	Type of contact		Supply voltage V	Color of push	Reference	Weight kg/lb
		NO	NC				
Complete units - With plain lens <sup>(2)</sup>							
	Direct supply for bulb with BA9s base fitting, 2.4 W max. (bulb not included)	1	1	≤ 250	White	<b>XB5AW3165</b> ( <b>ZB5AW065</b> + <b>ZB5AW31</b> )	0.057/0.126
					Green	<b>XB5AW3365</b> ( <b>ZB5AW065</b> + <b>ZB5AW33</b> )	0.057/0.126
					Red	<b>XB5AW3465</b> ( <b>ZB5AW065</b> + <b>ZB5AW34</b> )	0.057/0.126
					Orange	<b>XB5AW3565</b> ( <b>ZB5AW065</b> + <b>ZB5AW35</b> )	0.057/0.126
Heads only <sup>(3)</sup> - With plain lens <sup>(2)</sup>							
	Flush				White	<b>ZB5AW31</b>	0.018/0.040
					Green	<b>ZB5AW33</b>	0.018/0.040
					Red	<b>ZB5AW34</b>	0.018/0.040
					Orange	<b>ZB5AW35</b>	0.018/0.040
					Blue	<b>ZB5AW36</b>	0.018/0.040
					Clear	<b>ZB5AW37</b>	0.018/0.040

Illuminated pushbuttons with projecting push <sup>(1)</sup>				
Shape of head	Type of push	Color	Reference	Weight kg/lb
Heads only <sup>(2)</sup> - With plain lens <sup>(3)</sup>				
	Projecting	White	<b>ZB5AW11</b>	0.017/0.037
		Green	<b>ZB5AW13</b>	0.017/0.037
		Red	<b>ZB5AW14</b>	0.017/0.037
		Orange	<b>ZB5AW15</b>	0.017/0.037
		Blue	<b>ZB5AW16</b>	0.017/0.037
		Clear	<b>ZB5AW17</b>	0.017/0.037

(1) For recommended maximum number of contacts constituting the body (fixing collar and contact) associated with the head, see [page 26 and 27](#).

(2) For use with bodies comprising a light source with BA9s base fitting bulb (incandescent, neon, or LED) only.

(3) To add customized markings on these references using the web customization tool, see [page 5](#).

## Control and signaling units

Harmony XB5 plastic

Diameter 22 mm, multiple-headed pushbuttons, spring return



XB5AL73415



ZB5AA7121



ZB5AL7341



XB5AW73731•5



ZB5AW7A1721



ZB5AW7A3741

## Double-headed pushbuttons (1)

Screw clamp terminal connections (Schneider Electric anti-loosening system)

Shape of head	Description	Type of contact		Caps (2)		Reference	Weight kg/lb
		NO	NC	Marking	Background color		

## Complete units

	1 flush push, black 1 projecting push, red	1	1	White "I"	Green	XB5AL73415	0.053/0.117
				White "O"	Red		

## Heads only

	2 flush push, black			Unmarked	White	ZB5AA7120	0.023/0.051		
				Unmarked	Black				
				Black "I"	White			ZB5AA7121	0.023/0.051
				White "O"	Black				
				Unmarked	Green			ZB5AA7340	0.023/0.051
				Unmarked	Red				
				Black "→"	White			ZB5AA7213	0.023/0.051
				White "←"	Black				
				White "I"	Green			ZB5AA7341	0.023/0.051
				White "O"	Red				
	1 flush push, black 1 projecting push, red	1	1	Without cap (3)		ZB5AA79	0.023/0.051		
				Unmarked	Green			ZB5AL7340	0.023/0.051
				Unmarked	Red				
				White "I"	Green			ZB5AL7341	0.023/0.051
White "O"	Red								

## Double-headed pushbuttons with 1 white central pilot light block (1)

Screw clamp terminal connections (Schneider Electric anti-loosening system)

Shape of head	Description	Type of contact		Caps		Pilot light voltage V	Reference	Weight kg/lb
		NO	NC	Marking	Background color			

## Complete units

	1 flush push, black 1 projecting push, red 1 central pilot light block, white	1	1	White "I"	Green	24	XB5AW73731B5	0.066/0.146		
				White "O"	Red	120			XB5AW73731G5	0.066/0.146
						240				

## Heads only (5)

	2 flush push, black 1 central pilot light, clear (4)			Unmarked	White	ZB5AW7A1720	0.023/0.051		
				Unmarked	Black				
				Black "I"	White			ZB5AW7A1721	0.023/0.051
				White "O"	Black				
				Unmarked	Green			ZB5AW7A3740	0.023/0.051
				Unmarked	Red				
				White "I"	Green			ZB5AW7A3741	0.023/0.051
				White "O"	Red				
				Black "↑"	Green			ZB5AW7A1724	0.023/0.051
				White "↓"	Red				
Black "+"	White	ZB5AW7A1715	0.023/0.051						
Black "-"	White								
	1 flush push, black 1 projecting push, red 1 central pilot light, clear (4)	1	1	Without cap (3)		ZB5AW7A9	0.023/0.051		
				Unmarked	Green			ZB5AW7L3740	0.023/0.051
				Unmarked	Red				
				White "I"	Green			ZB5AW7L3741	0.023/0.051
White "O"	Red								

(1) Recommended maximum number of contacts constituting the body (fixing collar and contact) associated with the head, see page 26 and 27.

(2) These caps are factory assembled and cannot be removed (risk of damage).

(3) Caps to be ordered separately.

(4) Color of centrally positioned pilot light determined by the color of the LED incorporated in the body sub-assembly.

(5) Only for use with bodies comprising a light source with Universal LED.

# Control and signaling units Ø

Harmony XB5 plastic

Diameter 22 mm, multiple-headed pushbuttons, spring return



XB5AA731327



ZB5AA71124



ZBA7235



ZBA7331



ZBA7432



ZBA709

## Triple-headed pushbuttons (1) (2)

Screw clamp terminal connections (Schneider Electric anti-loosening system)

Shape of head	Description	Type of contact			Caps (3)		Reference	Weight kg/lb
		NO	NC	NO	Marking	Background color		

### Complete units

	2 flush push, black, 1 central projecting push, marked "Stop" in white	1	1	1	White "I" White "II"	Green Green	<a href="#">XB5AA731327</a>	0.063/0.139
					Black "→" White "←"	White Black	<a href="#">XB5AA711237</a>	0.063/0.139

### Heads only

	White "↑"				White "↑"	Green	<a href="#">ZB5AA73134</a>	0.023/0.051
	White "↓"				White "↓"	Green		
	Black "→"				Black "→"	White		
	White "←"				White "←"	Black	<a href="#">ZB5AA71123</a>	0.023/0.051
	Black "↑"				Black "↑"	White	<a href="#">ZB5AA71124</a>	0.023/0.051
	White "↓"				White "↓"	Black		
	White "↑"				White "↑"	Black	<a href="#">ZB5AA72124</a>	0.023/0.051
	White "↓"				White "↓"	Black		
	Without cap (4)						<a href="#">ZB5AA791</a>	0.023/0.051

## Specific accessories for multiple-headed pushbuttons

Description	Marking	Background color	Sold in lots of	Reference	Weight kg/lb
Caps only for clip-on mounting (5) on: - ZB5AA79 double-headed pushbuttons - ZB5AW7A9 double-headed pushbuttons + central pilot light block - ZB5AA791 triple-headed pushbuttons	Unmarked	White	10	<a href="#">ZBA71</a>	0.010/0.022
	"I" Black		10	<a href="#">ZBA7131</a>	0.010/0.022
	"↓" Black		10	<a href="#">ZBA7134</a>	0.010/0.022
	"+" Black		10	<a href="#">ZBA7138</a>	0.010/0.022
	Unmarked	Black	10	<a href="#">ZBA72</a>	0.010/0.022
	"O" White		10	<a href="#">ZBA7232</a>	0.010/0.022
	"↓" White		10	<a href="#">ZBA7235</a>	0.010/0.022
	"I" White		10	<a href="#">ZBA7237</a>	0.010/0.022
	Unmarked	Green	10	<a href="#">ZBA73</a>	0.010/0.022
	"I" White		10	<a href="#">ZBA7331</a>	0.010/0.022
	"↑" White		10	<a href="#">ZBA7335</a>	0.010/0.022
	Unmarked	Red	10	<a href="#">ZBA74</a>	0.010/0.022
	"O" White		10	<a href="#">ZBA7432</a>	0.010/0.022
	Unmarked	Yellow	10	<a href="#">ZBA75</a>	0.010/0.022
	Unmarked	Blue	10	<a href="#">ZBA76</a>	0.010/0.022
	Silicone boots for 2 flush push (6)	–	Clear	10	<a href="#">ZBA708</a>
Silicone boots for 3 pushes (6)	–		10	<a href="#">ZBA709</a>	0.055/0.121
Silicone boots for 1 flush push and 1 projecting push (6)	–		10	<a href="#">ZBA710</a>	0.055/0.121

(1) Recommended maximum number of contacts constituting the body (fixing collar and contact) associated with the head, see page 26 and 27.

(2) Not compatible with high power switching contacts and contacts for printed circuit board.

(3) These caps are factory assembled and cannot be removed (risk of damage).

(4) Caps to be ordered separately, see accessories on this page.

(5) Can be clipped-in at 90° steps, through 360°.

(6) Can be replaced without dismantling the head.

# Control and signaling units

Harmony XB5, plastic

Diameter 22 mm, mushroom head pushbuttons, spring return



XB5AC21



ZB5AC24



ZB5AC2



ZB5AR4

Mushroom head pushbuttons <sup>(1)</sup> <sup>(2)</sup>						
Screw clamp terminal connections (Schneider Electric anti-loosening system)						
Shape of head	Type of push	Type of contact		Push	Reference	Weight kg/lb
		NO	NC			
				Diameter Ø mm/in.	Color	
<b>Complete units</b>						
	Mushroom head	1	–	40/1.575	Black	<b>ZB5AC21</b> (ZB5AZ101 + ZB5AC2) 0.062/0.137
<b>Heads only</b>						
	Mushroom head			30/1.181	Black	<b>ZB5AC24</b> 0.027/0.060
					Green	<b>ZB5AC34</b> 0.027/0.060
					Red	<b>ZB5AC44</b> 0.027/0.060
					Yellow	<b>ZB5AC54</b> 0.027/0.060
					Blue	<b>ZB5AC64</b> 0.027/0.060
				40/1.575	Black	<b>ZB5AC2</b> 0.046/0.101
					Green	<b>ZB5AC3</b> 0.046/0.101
					Red	<b>ZB5AC4</b> 0.046/0.101
					Yellow	<b>ZB5AC5</b> 0.046/0.101
					Blue	<b>ZB5AC6</b> 0.046/0.101
				60/2.362	Black	<b>ZB5AR2</b> 0.065/0.143
					Green	<b>ZB5AR3</b> 0.065/0.143
					Red	<b>ZB5AR4</b> 0.065/0.143
					Yellow	<b>ZB5AR5</b> 0.065/0.143
					Blue	<b>ZB5AR6</b> 0.065/0.143

(1) These pushbuttons and heads cannot be used for an Emergency stop function. Therefore, it is recommended that a legend with a black or white background is used.

(2) Recommended maximum number of contacts constituting the body (fixing collar and contact) associated with the head, see page 26 and 27.

# Control and signaling units

## Harmony XB5, plastic

Diameter 22 mm, mushroom head pushbuttons, latching



ZB5AT2



ZB5AS62



ZB5AS72



ZB5AW733

Mushroom head pushbuttons (1) (2)					
Shape of head	Type of reset	Push Diameter Ø mm/in.	Color	Reference	Weight kg/lb
<b>Heads only</b>					
	Push-pull	30/1.181	Black	ZB5AT24	0.044/0.097
		40/1.575	Black	ZB5AT2	0.049/0.108
		60/2.362	Black	ZB5AX2	0.067/0.148
	Turn to release	30/1.181	Black	ZB5AS42	0.040/0.088
		40/1.575	Black	ZB5AS52	0.044/0.097
		40/1.575	Yellow	ZB5AS55	0.044/0.097
		60/2.362	Black	ZB5AS62	0.064/0.141
	Key release (key 455) (2 keys included with head) (3) (4)	30/1.181	Black	ZB5AS72	0.040/0.088
		40/1.575	Black	ZB5AS12	0.044/0.097

Illuminated mushroom head pushbuttons (2)					
Shape of head	Type of reset	Push Diameter Ø mm/in.	Color	Reference	Weight kg/lb
<b>Heads only (5)</b>					
	Turn to release	40/1.575	White	ZB5AW713	0.022/0.049
			Green	ZB5AW733	0.022/0.049
			Orange	ZB5AW753	0.022/0.049
			Blue	ZB5AW763	0.022/0.049



(1) These pushbuttons and heads cannot be used for an Emergency stop function. Therefore, it is recommended that a legend with a black or white background is used.  
 (2) Recommended maximum number of contacts constituting the body (fixing collar and contact) associated with the head, see page 26 and 27.  
 (3) For specific keys, please contact our Customer Care Center.  
 (4) The symbol indicates key withdrawal position(s).  
 (5) Only for use with bodies comprising a light source with Universal LED.

## Control and signaling units

Harmony XB5, plastic

Diameter 22 mm, Emergency stop and Emergency switching off functions

**Emergency stop and Emergency switching off functions conforming to EN/IEC 60204-1, 60364-5-53, EN/ISO 13850, and Machinery Directive 2006/42/EC**

Emergency stop function: Mushroom head Emergency stop trigger action and mechanical latching pushbuttons conform to standards EN/IEC 60204-1 and EN/ISO 13850, Machinery Directive 2006/42/EC, and standard EN/IEC 60947-5-5.

Emergency switching off function: Mushroom head switching off mechanical latching pushbuttons conform to standards IEC 60364-5-53 and EN/IEC 60947-5-5.

Please contact our Customer Care Center for an explanation of these standards and directives.

**Emergency stop and switching off pushbuttons with trigger action and mechanical latching (1) (2)**

Screw clamp terminal connections (Schneider Electric anti-loosening system)

Shape of head	Type of reset	Type of contact			Push Diameter Ø mm/in.	Color	Reference	Weight kg/lb
		NO	NC	NC MC(6)				

**Complete units**

	Push-pull	–	1	–	40/1.575	Red	<a href="#">XB5AT842</a> ( <a href="#">ZB5AZ102</a> + <a href="#">ZB5AT84</a> )	0.065/0.143
		1	1	–	40/1.575	Red	<a href="#">XB5AT845</a> ( <a href="#">ZB5AZ105</a> + <a href="#">ZB5AT84</a> )	0.076/0.168
	Turn to release	–	–	1	40/1.575	Red	<a href="#">XB5AS8446</a> ( <a href="#">ZBE302</a> + <a href="#">ZB5AZ009</a> + <a href="#">ZB5AS844</a> )	0.063/0.138
		–	1	–	40/1.575	Red	<a href="#">XB5AS8442</a> ( <a href="#">ZB5AZ102</a> + <a href="#">ZB5AS844</a> )	0.060/0.132
		1	1	–	40/1.575	Red	<a href="#">XB5AS8445</a> ( <a href="#">ZB5AZ105</a> + <a href="#">ZB5AS844</a> )	0.072/0.159
	Key release (key 455)(3)	–	1	–	40/1.575	Red	<a href="#">XB5AS8444</a> ( <a href="#">ZB5AZ104</a> + <a href="#">ZB5AS844</a> )	0.072/0.159
		–	1	1	40/1.575	Red	<a href="#">XB5AS84462</a> ( <a href="#">ZBE302</a> + <a href="#">ZB5AZ102</a> + <a href="#">ZB5AS844</a> )	0.075/0.165
		1	1	–	40/1.575	Red	<a href="#">XB5AS9442</a> ( <a href="#">ZB5AZ102</a> + <a href="#">ZB5AS944</a> )	0.075/0.165
		1	1	–	40/1.575	Red	<a href="#">XB5AS9445</a> ( <a href="#">ZB5AZ105</a> + <a href="#">ZB5AS944</a> )	0.112/0.247

**Heads only**

	Push-pull				30/1.181	Red	<a href="#">ZB5AT844</a>	0.049/0.108
					40/1.575	Red	<a href="#">ZB5AT84</a>	0.049/0.108
					60/2.362	Red	<a href="#">ZB5AX84</a>	0.067/0.148
	Turn to release				30/1.181	Red	<a href="#">ZB5AS834</a>	0.042/0.002
					40/1.575	Red	<a href="#">ZB5AS844</a> (5)	0.046/0.002
	Key release (key 455) (2 keys included with head) (3)(4) (5)				30/1.181	Red	<a href="#">ZB5AS934</a>	0.068/0.003
					40/1.575	Red	<a href="#">ZB5AS944</a>	0.071/0.003
					60/2.362	Red	<a href="#">ZB5AS964</a>	0.092/0.004
	Key release (key 4A185) (4)				40/1.575	Red	<a href="#">ZB5AS944D</a>	0.071/0.003

(1) For recommended maximum number of contacts constituting the body (fixing collar and contact) associated with the head, see [page 26](#) and [27](#).

(2) It is recommended that a legend or yellow background is used.

(3) The symbol  indicates key withdrawal position(s).

(4) For specific keys, please contact our Customer Care Center.

(5) To order a pushbutton head of Ø 60 mm/2.364 mm, replace the last 2 digits of the commercial reference with "64", example [ZB5AS844](#) becomes [ZB5AS864](#).

(6) NC contact block with monitoring dedicated for Emergency stop head only.



XB5AT845



XB5AS8445



XB5AS9445



ZB5AT84



ZB5AS844



ZB5AS834



ZB5AS934

# Control and signaling units

Harmony XB5, plastic

Diameter 22 mm, Illuminated rings for Emergency stop

Illuminated rings for Emergency stop (1)							
Description	Marking	Signaling	Supply voltage	Color	Sold in lots of	Reference	Weight kg/lb
Ø 60 mm/2.362 in. illuminated ring for Emergency stop	EMERGENCY STOP	Fixed, red	24 V ~	Yellow	1	ZBY9W2B330	0.031/0.068
	ARRET D'URGENCE	Fixed, red	24 V ~	Yellow	1	ZBY9W2B130	0.031/0.068
	NOT HALT	Fixed, red	24 V ~	Yellow	1	ZBY9W2B230	0.031/0.068
	PARADA DE EMERGENCIA	Fixed, red	24 V ~	Yellow	1	ZBY9W2B430	0.031/0.068
	ARRESTO DI EMERGENZA	Fixed, red	24 V ~	Yellow	1	ZBY9W2B630	0.031/0.068
	-	Fixed, red	24 V ~	Yellow	1	ZBY9W2B140	0.031/0.068
	EMERGENCY STOP	Fixed, red	120 V ~	Yellow	1	ZBY9W2G330	0.031/0.068
	ARRET D'URGENCE	Fixed, red	120 V ~	Yellow	1	ZBY9W2G130	0.031/0.068
	NOT HALT	Fixed, red	120 V ~	Yellow	1	ZBY9W2G230	0.031/0.068
	PARADA DE EMERGENCIA	Fixed, red	120 V ~	Yellow	1	ZBY9W2G430	0.031/0.068
	ARRESTO DI EMERGENZA	Fixed, red	120 V ~	Yellow	1	ZBY9W2G630	0.031/0.068
	-	Fixed, red	120 V ~	Yellow	1	ZBY9W2G140	0.031/0.068
	EMERGENCY STOP	Fixed, red	230 V ~	Yellow	1	ZBY9W2M330	0.031/0.068
	ARRET D'URGENCE	Fixed, red	230 V ~	Yellow	1	ZBY9W2M130	0.031/0.068
	NOT HALT	Fixed, red	230 V ~	Yellow	1	ZBY9W2M230	0.031/0.068
	PARADA DE EMERGENCIA	Fixed, red	230 V ~	Yellow	1	ZBY9W2M430	0.031/0.068
	ARRESTO DI EMERGENZA	Fixed, red	230 V ~	Yellow	1	ZBY9W2M630	0.031/0.068
	-	Fixed, red	230 V ~	Yellow	1	ZBY9W2M140	0.031/0.068
	EMERGENCY STOP	Fixed, red + white	24 V ~	Yellow	1	ZBY9W3B330	0.031/0.068
	ARRET D'URGENCE	Fixed, red + white	24 V ~	Yellow	1	ZBY9W3B130	0.031/0.068
NOT HALT	Fixed, red + white	24 V ~	Yellow	1	ZBY9W3B230	0.031/0.068	
PARADA DE EMERGENCIA	Fixed, red + white	24 V ~	Yellow	1	ZBY9W3B430	0.031/0.068	
ARRESTO DI EMERGENZA	Fixed, red + white	24 V ~	Yellow	1	ZBY9W3B630	0.031/0.068	
-	Fixed, red + white	24 V ~	Yellow	1	ZBY9W3B140	0.031/0.068	



ZBY9W2B330



ZBY9W3B140



ZBY9W2B501

Illuminated ring without legend for customization (use with ZBY9W101)							
Description	Marking	Signaling	Supply voltage	Color	Sold in lots of	Reference	Weight kg/lb
Ø 60 mm/2.362 in., No marking can be used with all Ø 22 mm/0.866 in. heads		Fixed, red	24 V ~	-	1	ZBY9W2B501	0.015/0.033
		Fixed, red + white	24 V ~	-	1	ZBY9W3B501	0.016/0.035



ZBY9W101

Customizable circular legend for illuminated ring without legend (2)		
Description	Reference	Weight kg/lb
Ø 60 mm/2.362 in.	ZBY9W101	0.004/0.009

Illuminated rings for mushroom head pushbuttons							
Description	Marking	Signaling	Supply voltage	Color	Sold in lots of	Reference	Weight kg/lb
Ø 60 mm/2.362 in. illuminated ring	-	Fixed, red	24 V ~	Yellow	1	ZBY9W2B101	0.031/0.068
	-	Fixed, red	120 V ~	Yellow	1	ZBY9W2G101	0.031/0.068
	-	Fixed, red	230 V ~	Yellow	1	ZBY9W2M101	0.031/0.068
	-	Fixed, red + white	24 V ~	Yellow	1	ZBY9W3B101	0.031/0.068



ZBY9W2B101

(1) For compliance with standard EN/ISO 13850, paragraph 4.4.6, the Emergency Stop function logo  has been added.  
 (2) To create customized marking on this reference using the web customization tool, see [page 43](#).

## Control and signaling units

Harmony XB5, plastic

Diameter 22 mm, Emergency stop and Emergency switching off functions

Circular yellow legends for Emergency stop



ZBY9121



ZBY9420

### Circular yellow legends for Emergency stop (1)

Description	Marking	Signaling	Supply voltage	Color	Sold in lots of	Reference	Weight kg/lb
Ø 60 mm/2.362 in. legend for Emergency stop function	-	-	-	Yellow	5	ZBY9121	0.007/0.015
	EMERGENCY STOP	-	-	Yellow	5	ZBY9320	0.007/0.015
	ARRET D'URGENCE	-	-	Yellow	5	ZBY9120	0.007/0.015
	NOT HALT	-	-	Yellow	5	ZBY9220	0.007/0.015
	PARADA DE EMERGENCIA	-	-	Yellow	5	ZBY9420	0.007/0.015
	ARRESTO DI EMERGENZA	-	-	Yellow	5	ZBY9620	0.007/0.015

### Emergency stop and Emergency switching off functions conforming to EN/IEC 60204-1, 60364-5-53, EN/ISO 13850, and Machinery Directive 2006/42/EC

Emergency stop function: Mushroom head Emergency stop trigger action and mechanical latching pushbuttons conform to standards EN/IEC 60204-1 and EN/ISO 13850, Machinery Directive 2006/42/EC, and standard EN/IEC 60947-5-5.

Emergency switching off function: Mushroom head switching off mechanical latching pushbuttons conform to standards IEC 60364-5-53 and EN/IEC 60947-5-5.

Please contact our Customer Care Center for an explanation of these standards and directives.

### Illuminated and non illuminated Emergency stop and Emergency switching off pushbuttons with trigger action and mechanical latching

Shape of head	Type of reset	Signaling type	Type of contact		Supply voltage V	Diameter Ø mm/in.	Color of the push	Reference	Weight kg/lb
			NO	NC					

#### Complete units

	Turn to release	Fixed white + fixed red, bi-color	1	1	24 ~	60/2.362	Red	ZB5AS84W3B5	0.107/0.236
			1	2	24 ~	60/2.362	Red	ZB5AS84W3B41	0.117/0.258

#### Heads only

	Turn to release	-	-	-	60/2.362	Red	ZB5AS84W00	0.055/0.121	
		Fixed, red	-	-	24 ~	60/2.362	Red	ZB5AS84W2B	0.055/0.121
		Fixed, red	-	-	120 ~	60/2.362	Red	ZB5AS84W2G	0.055/0.121
		Fixed, red	-	-	230 ~	60/2.362	Red	ZB5AS84W2M	0.055/0.121
		Fixed white + fixed red, bi-color	-	-	24 ~	60/2.362	Red	ZB5AS84W3B	0.055/0.121

### Circular yellow legends for Emergency stop ZB5AS84W●● (1)

Description	Marking	Color	Sold in lots of	Reference	Weight kg/lb
Ø 90 mm/1.181 in. legend for Emergency stop function	EMERGENCY STOP	Yellow	10	ZBY8L330	0.055/0.121
	-	Yellow	10	ZBY8L140	0.055/0.121

(1) For compliance with standard EN/ISO 13850, paragraph 4.4.6, the Emergency Stop function logo has been added.



XB5AS84W3B5



ZB5AS84W2B



ZBY8L330

# Control and signaling units

Harmony XB5, plastic

Diameter 22 mm, Emergency stop and Emergency switching off functions

Circular yellow legends for Emergency stop

**Emergency stop and Emergency switching off functions conforming to EN/IEC 60204-1, 60364-5-53, EN/ISO 13850, and Machinery Directive 2006/42/EC**

Emergency stop function: Mushroom head Emergency stop trigger action and mechanical latching pushbuttons conform to standards EN/IEC 60204-1 and EN/ISO 13850, Machinery Directive 2006/42/EC, and standard EN/IEC 60947-5-5. Emergency switching off function: Mushroom head switching off mechanical latching pushbuttons conform to standards IEC 60364-5-53 and EN/IEC 60947-5-5.

Please contact our Customer Care Center for an explanation of these standards and directives.

**Illuminated Emergency stop and Emergency switching off functions, mechanical latching pushbuttons with mechanical state indicator (1)**

For elevator inspection box applications



ZB5AT8643M

Shape of head	Type of reset	Push Diameter Ø mm/in.	Color	Unit reference	Weight kg/lb
<b>Heads only (2)</b>					
	<b>Push-pull (1)(3)</b> For Emergency stop and Emergency switching off function	40/1.575	Red	<b>ZB5AT8643M</b>	0.034/0.075



ZB5AT8643M330

Description	Conforming to standards	Marking on yellow background	Sold in lots of	Reference	Weight kg/lb
<b>Illuminated Emergency stop function ZB5AT8643M with Ø 60mm/2.362 in. legend plate</b>	EN/IEC 60204-1 -	-	10	<b>ZB5AT8643M140</b>	0.034/0.075
	EN/ISO 13850	ARRET D'URGENCE	10	<b>ZB5AT8643M130</b>	0.034/0.075
		EMERGENCY STOP	10	<b>ZB5AT8643M330</b>	0.034/0.075
		NOT HALT	10	<b>ZB5AT8643M230</b>	0.034/0.075
		PARADA DE EMERGENCIA	10	<b>ZB5AT8643M430</b>	0.034/0.075
		ARRESTO DI EMERGENZA	10	<b>ZB5AT8643M630</b>	0.034/0.075



ZB5AW743

**Illuminated Emergency switching off function only, mechanical latching pushbuttons**

Screw clamp terminal connections (Schneider Electric anti-loosening system)

Shape of head	Type of reset	Push Diameter Ø mm/in.	Color	Reference	Weight kg/lb
	<b>Turn to release</b>	40/1.575	Red	<b>ZB5AW743</b>	0.022/0.049



ZBY9360

**Circular yellow legends for ZB5AW743**

Diameter mm/in.	Conforming to standards	Marking on yellow background	Sold in lots of	Reference	Weight kg/lb
<b>Used for "Emergency switching off" function</b>					
<b>60/2.362</b>	EN/IEC 60204-1 -	-	10	<b>ZBY9101</b>	0.004/0.009
		COUPURE D'URGENCE	10	<b>ZBY9160</b>	0.004/0.009
		EMERGENCY SWITCHING OFF	10	<b>ZBY9360</b>	0.004/0.009
		NOT-AUS	10	<b>ZBY9260</b>	0.004/0.009
<b>90/3.543</b>	EN/IEC 60204-1 -	-	10	<b>ZBY8101</b>	0.008/0.018
		COUPURE D'URGENCE	10	<b>ZBY8160</b>	0.008/0.018

(1) For recommended maximum number of contacts constituting the body (fixing collar and contact) associated with the head, see page 26 and 27.

(2) For use with bodies comprising a light source with Universal LED only.

(3) Cannot be used with metal guards ZBZ160.

## Control and signaling units

Harmony XB5, plastic

Diameter 22 mm, Emergency stop and Emergency switching off functions

Circular yellow legends for Emergency stop

### Emergency stop and Emergency switching off functions conforming to EN/IEC 60204-1, 60364-5-53, EN/ISO 13850, and Machinery Directive 2006/42/EC

Emergency stop function: Mushroom head Emergency stop trigger action and mechanical latching pushbuttons conform to standards EN/IEC 60204-1 and EN/ISO 13850, Machinery Directive 2006/42/EC, and standard EN/IEC 60947-5-5.

Emergency switching off function: Mushroom head switching off mechanical latching pushbuttons conform to standards IEC 60364-5-53 and EN/IEC 60947-5-5.

Please contact our Customer Care Center for an explanation of these standards and directives.

### Emergency stop with monitoring contacts, trigger action, and mechanical latching Screw clamp terminal connection

Shape of head	Type of reset	Type of contact		Supply voltage V	Push		Reference	Weight kg/lb
		NO	NC		Diameter Ø mm/in.	Color		

#### Non-illuminated

	Push-pull and Turn to release	1	2	–	40/1.575	Red	<a href="#">XB5AS84449</a>	0.090/0.198
---	-------------------------------	---	---	---	----------	-----	----------------------------	-------------

#### Illuminated (red)

	Push-pull and Turn to release	1	2	24 V AC	40/1.575	Red	<a href="#">XB5AS86449B4</a>	0.094/0.207
---	-------------------------------	---	---	---------	----------	-----	------------------------------	-------------

### Circular yellow legends for Emergency stop XB5AS84449 or XB5AS86449B4

Description	Marking	Color	Sold in lots of	Reference	Weight kg/lb
Ø 60 mm/ 2.362 in. legend for Emergency stop function	-	Yellow	5	<a href="#">ZBY9141</a>	0.007/0.015
	EMERGENCY STOP	Yellow	5	<a href="#">ZBY9142</a>	0.007/0.015



XB5AS84449



XB5AS86449B4



ZBY9142

# Control and signaling units

Harmony XB5, plastic

Diameter 22 mm, Illuminated rings and circular yellow legends for mushroom head pushbuttons

## Circular yellow legends for mushroom head pushbuttons (1)

Used for "Emergency stop" function (1)

Diameter mm/in.	Conforming to standards	Marking on yellow background	Sold in lots of	Reference	Weight kg/lb
60/2.363	EN/IEC 60204-1	-	5	ZBY9121	0.007/0.015
		EMERGENCY STOP	5	ZBY9320	0.007/0.015
		ARRET D'URGENCE	5	ZBY9120	0.007/0.015
		NOT-HALT	5	ZBY9220	0.007/0.015
		PARADA DE EMERGENCIA	5	ZBY9420	0.007/0.015
90/3.543	EN/IEC 60204-1 and EN/ISO 13850	ARRET D'URGENCE	10	ZBY8130	0.008/0.018
		EMERGENCY STOP	10	ZBY8330	0.008/0.018
		NOT-HALT	10	ZBY8230	0.008/0.018
		PARADA DE EMERGENCIA	10	ZBY8430	0.008/0.018
		ARRESTO DI EMERGENZA	10	ZBY8630	0.008/0.018



ZBY9320



ZBY9360

(1) For compliance with standard EN/ISO 13850, paragraph 4.4.6, the Emergency Stop function logo  has been added.

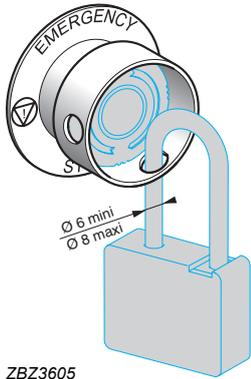

ZBZ3605

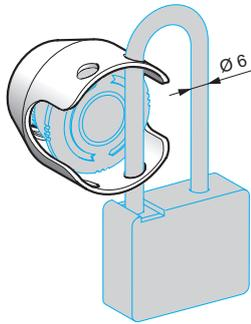

ZBZ160●



ZBZ1605



ZBY9330T

#### Accessories for mushroom head pushbuttons (5)

Description	Exclusive use with the following Ø 40 mm/1.575 in. trigger action pushbuttons	Color	Reference	Weight kg/lb
<b>Padlocking kit (1) (2)</b> for Emergency stop (3) and Emergency switching off function (4), (padlockable)	XB5AS844● XB5AS944● ZB5AS844 ZB5AS944●	Yellow	<a href="#">ZBZ3605</a>	0.045/0.099
<b>Metal guards</b> for Emergency stop function, padlockable (2)	XB5AT8● XB5AS8● XB5AS9● ZB5AT8● ZB5AS8● ZB5AS9●	Chromium plated	<a href="#">ZBZ1600</a>	0.046/0.101
		Black	<a href="#">ZBZ1602</a>	0.046/0.101
		Red	<a href="#">ZBZ1604</a>	0.046/0.101
		Yellow	<a href="#">ZBZ1605</a>	0.046/0.101
		Blue	<a href="#">ZBZ1606</a>	0.046/0.101

Description	Marking	Color	Reference	Weight kg/lb
Ø 60 mm/2.363 in. legend for padlocking device <b>ZBZ3605</b> for Emergency stop function (3)	-	Yellow	<a href="#">ZBY9140T</a>	0.004/0.009
	ARRET D'URGENCE	Yellow	<a href="#">ZBY9130T</a>	0.004/0.009
	EMERGENCY STOP	Yellow	<a href="#">ZBY9330T</a>	0.004/0.009
	NOT-HALT	Yellow	<a href="#">ZBY9230T</a>	0.004/0.009

(1) No isolation function is possible when this guard is fitted.

(2) Standard circular legends are not compatible with this product. Use special legends **ZBY9●●●T**.

(3) For conformity with standards EN/IEC 60204-1 and EN/ISO 13850.

(4) For conformity with standard EN/IEC 60204-1.

(5) To add customized markings on these references using the web customization tool, see [page 5](#).

# Control and signaling units

## Harmony XB5, plastic

### Diameter 22 mm, Accessories for pushbuttons



ZBY9330M

#### Circular yellow legends for metal guard ZBZ16●● (1)

Description	Marking	Color	Sold in lots of	Reference	Weight kg/lb
<b>For Emergency stop function</b>					
Ø 60 mm/2.362 in. legend for metal guard ZBZ16●●	Without	Yellow	10	<a href="#">ZBY9140M</a>	0.004/0.009
	ARRET D'URGENCE	Yellow	10	<a href="#">ZBY9130M</a>	0.004/0.009
	EMERGENCY STOP	Yellow	10	<a href="#">ZBY9330M</a>	0.004/0.009
	NOT-HALT	Yellow	10	<a href="#">ZBY9230M</a>	0.004/0.009
	PARADA DE EMERGENZA	Yellow	10	<a href="#">ZBY9430M</a>	0.004/0.009
	NOODSTOP	Yellow	10	<a href="#">ZBY9530M</a>	0.004/0.009
	ARRESTO DI EMERGENZA	Yellow	10	<a href="#">ZBY9630M</a>	0.004/0.009
	NODSTOPP	Yellow	10	<a href="#">ZBY9730M</a>	0.004/0.009
	NODSTOP	Yellow	10	<a href="#">ZBY9830M</a>	0.004/0.009

#### For Emergency switching off function

Ø 60 mm/2.362 in. legend for metal guard ZBZ16●●	Without	Yellow	10	<a href="#">ZBY9101M</a>	0.004/0.009
	COUPURE D'URGENCE	Yellow	10	<a href="#">ZBY9160M</a>	0.004/0.009
	EMERGENCY SWITCHING OFF	Yellow	10	<a href="#">ZBY9360M</a>	0.004/0.009
	NOT-AUS	Yellow	10	<a href="#">ZBY9260M</a>	0.004/0.009
	DESCONEXION DE EMERGENCIA	Yellow	10	<a href="#">ZBY9460M</a>	0.004/0.009



ZBY9360M

(1) To add customized markings on these references using the web customization tool, see [page 5](#).

## Control and signaling units

Harmony XB5, plastic

Diameter 22 mm, Accessories for pushbuttons

Bellows for harsh environment



ZBZ2102



ZB4BZ1905



ZB4BZ2005



ZB4BZ64



ZBZ58

## Other accessories

Description	For use with	Color	Reference	Weight kg/lb
Plastic guard	Selector switches and key switches	Black	ZBZ2102	0.005/0.011
	Emergency stop and Emergency switching off function	Yellow	Round guard 63.5 mm/2.5 in. ZB4BZ1905	0.042/0.093
		Yellow	Round guard 76.2 mm/3.0 in. ZB4BZ2105	0.058/0.128
		Yellow	Narrow flange guard ZB4BZ2005	0.032/0.071
Padlockable flaps	Flush type pushbuttons	Black	ZB4BZ62	0.076/0.168
		Red	ZB4BZ64	0.076/0.168
		Yellow	ZB4BZ65	0.076/0.168
		Blue	ZB4BZ66	0.076/0.168

Description	Material	For use with	Color	Sold in lots of	Unit reference	Weight kg/lb
<b>Bellows seals for harsh environments</b> (environments subject to humidity, dust, high-pressure cleaning, etc.) (1)	Silicone	Other functions	Black	2	ZBZ28	0.009/0.020
		Emergency stop/ switching off function	Yellow	2	ZBZ58	0.009/0.020

Description	Application	Sold in lots of	Unit reference	Weight kg/lb
<b>Boot for contact block</b> ZBE10● and ZBE10●3 (2)	For protection against dusty environment	1	ZBZ60	0.098/0.216

(1) Only when mounted on control stations. Use legends ZBY9●●●T.

(2) Restriction on use: Refer to the product instruction sheet on the Schneider Electric website, Harmony XB5 page.

## Control and signaling units

Harmony XB5, plastic

Diameter 22 mm, General safe stops

Bellows for harsh environments

### General safe stops

General safe stops are used to stop the operation of a machine in a safe manner. These devices cannot be used as an Emergency stop and must not be associated with a yellow background. General safe stops comprise a yellow bezel and black head.



ZB5AS842Y

Shape of head	Type of reset	Push		Reference	Weight kg/lb
		Diameter Ø mm/in.	Color		
	Turn to release	40/1.575	Black	ZB5AS842Y	0.046/0.101

### Bellows for harsh environments (2)

Description	Material	For use with	Color	Sold in lots of	Unit reference	Weight kg/lb
For use in environments subject to humidity, dust, high pressure cleaning, etc.	Silicone	Other functions	Black	2	ZBZ28	0.009/0.020
		Emergency stop/switching off function	Yellow	2	ZBZ58	0.009/0.020



ZBZ58

(1) Not compatible with Ø 30 mm/1.181 in. pushbuttons.

# Control and signaling units

Harmony XB5 plastic

Diameter 22 mm, Large head pushbuttons with integrated bellows



ZB5AC680

Pushbuttons with integrated bellows				
Shape of head	Color of push	Marking Text (color)	Reference	Weight kg/lb
<b>Heads only, Ø 37 mm without marking</b>				
Flush 	White	–	ZB5AC180	0.024/0.053
	Black	–	ZB5AC280	0.024/0.053
	Green	–	ZB5AC380	0.024/0.053
	Red	–	ZB5AC480	0.024/0.053
	Yellow	–	ZB5AC580	0.024/0.053
	Blue	–	ZB5AC680	0.024/0.053



ZB5AC48021

<b>Heads only, Ø 37 mm with marking (1)</b>				
Flush 	Red	“O” (white)	ZB5AC48021	0.024/0.053
	Green	“I” (white)	ZB5AC38023	0.024/0.053
	Black	“  ” (white)	ZB5AC28001	0.024/0.053



ZBZ1902

Accessories			
Description	Function	Reference	Weight kg/lb
Protective guard in plastic	Protection against accidental operation	ZBZ1902 (2)	0.010/0.022



ZBZ60

Boot for contact block ZBE10●, ZBE10●3, and ZBE50● (3)	Protection against liquid and dust ingress	ZBZ60	0.098/ 0.216
--	--	-------	--------------

**Other Version** Customization with marking at your choice (texts or symbols)  
Rotation of head for horizontal mounting of the contact block (1)  
Please contact our Customer Care Centre.

(1) Heads are fixed relative to the position of the contact blocks: contact blocks are normally used in the “vertical” position. It is necessary to order an alternative head with the symbol rotated by 90° in order to mount the contact block in the “horizontal” position. Please add the suffix “RA” at the end of the product reference for alternative heads of your choice.

(2) For heads with the RA suffix (ZB4BC●●●RA) used with a guard, it is necessary to order the dedicated guard ZBZ1902RA.

(3) Restriction for use: refer to the product instruction sheet on [www.schneider-electric.com](http://www.schneider-electric.com).

# Control and signaling units

Harmony XB5, plastic

Diameter 22 mm Pushbuttons, push-push



ZB5AH03C0



ZB5AH04



ZB5AH4C0



ZB5AH083



ZB5AH063C0

## Pushbuttons with flush push <sup>(1)</sup>

Shape of head	Type of push	Color of push	Reference		Weight kg/lb
			For black bezel	For gray bezel	
<b>Heads only, circular</b>					
	Flush	White	ZB5AH01	ZB5AH01C0	0.018/0.040
		Black	ZB5AH02	ZB5AH02C0	0.018/0.040
		Green	ZB5AH03	ZB5AH03C0	0.018/0.040
		Red	ZB5AH04	ZB5AH04C0	0.018/0.040
		Yellow	ZB5AH05	ZB5AH05C0	0.018/0.040
		Blue	ZB5AH06	ZB5AH06C0	0.018/0.040z

## Pushbuttons with projecting push <sup>(1)</sup>

Shape of head	Type of push	Color of push	Reference		Weight kg/lb
			For black bezel	For gray bezel	
<b>Heads only, circular</b>					
	Projecting	White	ZB5AH1	ZB5AH1C0	0.018/0.040
		Black	ZB5AH2	ZB5AH2C0	0.018/0.040
		Green	ZB5AH3	ZB5AH3C0	0.018/0.040
		Red	ZB5AH4	ZB5AH4C0	0.018/0.040
		Yellow	ZB5AH5	ZB5AH5C0	0.018/0.040
		Blue	ZB5AH6	ZB5AH6C0	0.018/0.040

## Illuminated pushbuttons with flush push <sup>(1)</sup>

Shape of head	Type of push	Color of push	Reference		Weight kg/lb
			For black bezel	For gray bezel	
<b>Heads only, circular <sup>(2) (3)</sup></b>					
	Projecting	White	ZB5AH013	ZB5AH013C0	0.017/0.037
		Green	ZB5AH033	ZB5AH033C0	0.017/0.037
		Red	ZB5AH043	ZB5AH043C0	0.018/0.040
		Orange	ZB5AH053	ZB5AH053C0	0.017/0.037
		Blue	ZB5AH063	ZB5AH063C0	0.017/0.037
		Yellow	ZB5AH083	ZB5AH083C0	0.017/0.037

## Illuminated pushbuttons with projecting push <sup>(1)</sup>

Shape of head	Type of push	Color of push	Reference		Weight kg/lb
			For black bezel	For gray bezel	
<b>Heads only, circular <sup>(2) (3)</sup></b>					
	Projecting	White	ZB5AH13	ZB5AH13C0	0.017/0.037
		Green	ZB5AH33	ZB5AH33C0	0.017/0.037
		Red	ZB5AH43	ZB5AH43C0	0.017/0.037
		Orange	ZB5AH53	ZB5AH53C0	0.017/0.037
		Blue	ZB5AH63	ZB5AH63C0	0.017/0.037
		Yellow	ZB5AH83	ZB5AH83C0	0.017/0.037

(1) For recommended maximum number of contacts constituting the body (fixing collar and contact) associated with the head, see [page 26](#) and [page 27](#).

(2) For use with bodies comprising a light source with universal LED only.

(3) To add customized markings on these references using the web customization tool, see [page 5](#).

## Control and signaling units

Harmony XB5, plastic

Diameter 22 mm Pushbuttons, “push-turn to release”

Pushbuttons with key-operated push <sup>(1)</sup>

Shape of head	Type of push	Marking	Reference	Weight kg/lb
<b>Heads only</b>				
	Knurled without cap <sup>(2)</sup>	–	ZB5AF	0.027/0.060
	Knurled with marked cap	↑ (white on black background)	ZB5AF351	0.030/0.066



ZB5AF



ZB5AF351

(1) For recommended maximum number of contacts constituting the body (fixing collar and contact) associated with the head, see [page 26](#) and [27](#).

(2) Colored caps to be ordered separately, see [page 68](#).

# Control and signaling units

Harmony XB5, plastic

Diameter 22 mm selector switches with standard handle

Selector switches with standard handle <sup>(1)</sup>									
Screw clamp terminal connections (Schneider Electric anti-loosening system)									
Shape of head	Type of operator	Type of contact		Positions		Reference	Reference		Weight kg/lb
		NO	NC	Number	Type		For black bezel	For gray bezel	

**Complete units <sup>(2)</sup>**



XB5AD33



XB5AD33C0

	Standard handle, black	1	–	2-position 90°	Stay put	∨	XB5AD21 <sup>(3)</sup> (ZB5AZ101 + ZB5AD2)	XB5AD21C0 (ZB5AZ101 + ZB5AD2C0)	0.043/0.095
		1	–		Spring return from right to left	∩	XB5AD41 (ZB5AZ101 + ZB5AD4)	XB5AD41C0 (ZB5AZ101 + ZB5AD4C0)	0.046/0.101
		1	1		Stay put	∨	XB5AD25 (ZB5AZ105 + ZB5AD2)	XB5AD25C0 (ZB5AZ105 + ZB5AD2C0)	0.043/0.095
		2	–	3-position ± 45°	Stay put	∨	XB5AD33 (ZB5AZ103 + ZB5AD3)	XB5AD33C0 (ZB5AZ103 + ZB5AD3C0)	0.043/0.095
Spring return to center	∩				XB5AD53 (ZB5AZ103 + ZB5AD5)	XB5AD53C0 (ZB5AZ103 + ZB5AD5C0)	0.043/0.095		

**Heads only <sup>(2)</sup>**



ZB5AD2

	Standard handle, black	2-position 90°	Stay put	∨	ZB5AD2	ZB5AD2C0	0.017/0.037
			Spring return from right to left	∩	ZB5AD4	ZB5AD4C0	0.020/0.044
		3-position ± 45°	Stay put	∨	ZB5AD3	ZB5AD3C0	0.017/0.037
			Spring return to center	∩	ZB5AD5	ZB5AD5C0	0.017/0.037
			Spring return from left to center	∩	ZB5AD7	ZB5AD7C0	0.017/0.037
			Spring return from right to center	∩	ZB5AD8	ZB5AD8C0	0.017/0.037

**Heads only with other colored handles <sup>(2)</sup>**



ZB5AD204

	Standard handle, white	Add suffix <b>01</b> to the reference, for example: ZB5AD201	ZB5AD201C0
	Standard handle, green	Add suffix <b>03</b> to the reference, for example: ZB5AD203	ZB5AD203C0
	Standard handle, red	Add suffix <b>04</b> to the reference, for example: ZB5AD204	ZB5AD204C0
	Standard handle, yellow	Add suffix <b>05</b> to the reference, for example: ZB5AD205	ZB5AD205C0
	Standard handle, blue	Add suffix <b>06</b> to the reference, for example: ZB5AD206	ZB5AD206C0

(1) For recommended maximum number of contacts and sequence of contacts constituting the body (fixing collar and contact) associated with the head, see page 26 and 27.

(2) To add customized markings on these references using the web customization tool, see page 5.

(3) To order products with 1NO and 1NC contact, replace the last digit of the commercial reference with a 5, example: XB5AA21 becomes XB5AA25.

## Control and signaling units

Harmony XB5, plastic

Diameter 22 mm selector switches with long handle



ZB5AJ3

Selector switches with long handle (1)											
Screw clamp terminal connections (Schneider Electric anti-loosening system)											
Shape of head	Type of operator	Type of contact		Positions		Reference		Weight kg/lb			
		NO	NC	Number	Type	For black bezel	For gray bezel				
<b>Complete units (2)</b>											
	Long handle, black	1	-	2-position 90°	Stay put	✓	<b>XB5AJ21</b> ( <b>ZB5AZ101</b> + <b>ZB5AJ2</b> )	<b>XB5AJ21C0</b> ( <b>ZB5AZ101</b> + <b>ZB5AJ2C0</b> )	0.043/0.095		
					3-position ± 45°	Stay put	✓	<b>XB5AJ33</b> ( <b>ZB5AZ103</b> + <b>ZB5AJ3</b> )		<b>XB5AJ33C0</b> ( <b>ZB5AZ103</b> + <b>ZB5AJ3C0</b> )	0.043/0.095
					Spring return to center	✓	<b>XB5AJ53</b> ( <b>ZB5AZ103</b> + <b>ZB5AJ5</b> )	<b>XB5AJ53C0</b> ( <b>ZB5AZ103</b> + <b>ZB5AJ5C0</b> )		0.043/0.095	
<b>Heads only (2)</b>											
	Long handle, black	2-position 90°	-	2-position 90°	Stay put	✓	<b>ZB5AJ2</b>	<b>ZB5AJ2C0</b>	0.017/0.037		
					Spring return from right to left	✓	<b>ZB5AJ4</b>	<b>ZB5AJ4C0</b>		0.020/0.044	
					3-position ± 45°	Stay put	✓	<b>ZB5AJ3</b>	<b>ZB5AJ3C0</b>	0.017/0.037	
						Spring return to center	✓	<b>ZB5AJ5</b>	<b>ZB5AJ5C0</b>		0.017/0.037
					3-position ± 45°	Spring return from left to center	✓	<b>ZB5AJ7</b>	<b>ZB5AJ7C0</b>	0.017/0.037	
						Spring return from right to center	✓	<b>ZB5AJ8</b>	<b>ZB5AJ8C0</b>		0.017/0.037

(1) For recommended maximum number of contacts and sequence of contacts constituting the body (fixing collar and contact) associated with the head, see [page 26](#) and [27](#).

(2) To add customized markings on these references using the web customization tool, see [page 5](#).

# Control and signaling units

Harmony XB5, plastic

Diameter 22 mm Key switches

Key 455, 8D1, 421E, 458A, 520E, or 3131A

Key switches <sup>(1)</sup>									
Screw clamp terminal connections (Schneider Electric anti-loosening system)									
Shape of head operator	Type of operator	Type of contact	Positions <sup>(2)</sup>		Reference	Weight			
			Number	Type		kg	lb		
						For black bezel	For gray bezel		
		NO	NC						
<b>Complete units <sup>(4)</sup></b>									
 XB5AG3	 Key switch with key 455	1	-	2-position 90°	Stay put 	<b>XB5AG21</b> (ZB5AZ101 + ZB5AG2)	<b>XB5AG21C0</b> (ZB5AZ101 + ZB5AG2C0)	0.831/1.832	
						<b>XB5AG41</b> (ZB5AZ101 + ZB5AG4)	<b>XB5AG41C0</b> (ZB5AZ101 + ZB5AG4C0)	0.831/1.832	
					Spring return to left 	<b>XB5AG61</b> (ZB5AZ101 + ZB5AG6)	<b>XB5AG61C0</b> (ZB5AZ101 + ZB5AG6C0)	0.870/1.918	
 XB5AG03C0		2	-	3-position ±45°	Stay put 	<b>XB5AG03</b> (ZB5AZ103 + ZB5AG0)	<b>XB5AG03C0</b> (ZB5AZ103 + ZB5AG0C0)	0.831/1.832	
						<b>XB5AG33</b> (ZB5AZ103 + ZB5AG3)	<b>XB5AG33C0</b> (ZB5AZ103 + ZB5AG3C0)	0.831/1.832	
<b>Heads only <sup>(4)</sup></b>									
 ZB5AG2   ZB5AG3	 Key switch with key 455 <sup>(3)</sup>			2-position 90°	Stay put 	<b>ZB5AG2</b>	<b>ZB5AG2C0</b>	0.057/0.126	
						<b>ZB5AG02</b>	-	0.057/0.126	
						<b>ZB5AG4</b>	<b>ZB5AG4C0</b>	0.057/0.126	
					Spring return from right to left 	<b>ZB5AG6</b>	<b>ZB5AG6C0</b>	0.061/0.134	
					3-position ±45°	Stay put 	<b>ZB5AG0</b>	<b>ZB5AG0C0</b>	0.057/0.126
							<b>ZB5AG3</b>	<b>ZB5AG3C0</b>	0.057/0.126
							<b>ZB5AG5</b>	-	0.057/0.126
							<b>ZB5AG9</b>	<b>ZB5AG9C0</b>	0.057/0.126
							<b>ZB5AG09</b>	-	0.057/0.126
					Spring return from left to center 	<b>ZB5AG1</b>	-	0.057/0.126	
					Spring return to center 	<b>ZB5AG7</b>	<b>ZB5AG7C0</b>	0.057/0.126	
					Spring return from right to center 	<b>ZB5AG8</b>	-	0.057/0.126	
	<b>ZB5AG05</b>	<b>ZB5AG05C0</b>	0.057/0.126						
	<b>ZB5AG08</b>	<b>ZB5AG08C0</b>	0.057/0.126						

(1) For recommended maximum number of contacts and sequence of contacts constituting the body (fixing collar and contact) associated with the head, see page 26 and 27.

(2) The symbol  indicates key withdrawal position(s).

(3) For specific keys, please contact our Customer Care Center.

(4) To add customized markings on these references using the web customization tool, see page 5.

## Control and signaling units

Harmony XB5, plastic

Diameter 22 mm Key switches with key 8D1

Selector switches with knurled knob, toggle switches



ZB5AG2DC0

Key switches (continued) (1)								
Screw clamp terminal connections (Schneider Electric anti-loosening system)								
Shape of head	Type of operator	Positions (2)			Reference		Weight kg/lb	
		Number	Type		For black bezel	For gray bezel		
	Key switch with key 8D1	2-position 90°	Stay put		ZB5AG2D	ZB5AG2DC0	0.057/0.126	
					ZB5AG02D	–	0.057/0.126	
						ZB5AG4D	ZB5AG4DC0	0.057/0.126
						ZB5AG6D	–	0.061/0.134
						ZB5AG0D	–	0.057/0.126
						ZB5AG3D	–	0.057/0.126
						ZB5AG03D	–	0.057/0.126
						ZB5AG07D	–	0.057/0.126
						ZB5AG7D	–	0.057/0.126
						–	–	–

Selector switches with knurled knob (1)							
Shape of head	Type of operator	Positions			Reference		Weight kg/lb
		Number	Type		For black bezel	For gray bezel	
Heads only (3)							
	Black knurled knob	2-position 90°	Stay put		ZB5AD29	ZB5AD29C0	0.020/0.044
					–	ZB5AD49C0	0.024/0.053
		3-position ± 45°	Stay put		ZB5AD39	ZB5AD39C0	0.020/0.044
					ZB5AD59	ZB5AD59C0	0.020/0.044
					–	ZB5AD79C0	0.020/0.044
					–	ZB5AD89C0	0.020/0.044



ZB5AD39

Toggle switches (1)							
Shape of head	Type of operator	Positions			Reference		Weight kg/lb
		Number	Type		For black bezel	For gray bezel	
Heads only (3)							
	Black lever	2-position 90°	Stay put		ZB5AD28	ZB5AD28C0	0.023/0.051
					–	ZB5AD48C0	0.023/0.051
	White lever	2-position 90°	Stay put		ZB5AD2801	ZB5AD2801C0	0.023/0.051
					ZB5AD2804	ZB5AD2804C0	0.023/0.051
					–	ZB5AD2806C0	0.023/0.051



ZB5AD28



ZB5AD2804C0

(1) For recommended maximum number of contacts and sequence of contacts constituting the body (fixing collar and contact) associated with the head, see [page 26](#) and [27](#).

(2) The symbol  indicates key withdrawal position(s).

(3) To add customized markings on these references using the web customization tool, see [page 5](#).

# Control and signaling units

Harmony XB5, plastic

Diameter 22 mm Illuminated selector switches with standard handle, with Universal light block

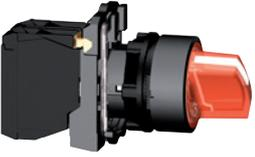
Illuminated selector switches with standard handle, with Universal light block <sup>(1)</sup>															
Screw clamp terminal connections (Schneider Electric anti-loosening system)															
Shape of head operator	Type of operator	Type of contact	Positions	Supply voltage V	Color of handle	Reference		Weight kg/lb							
						For black bezel	For gray bezel								
		NO	NC	Number and type											
<b>Complete units <sup>(2)</sup></b>															
 XB5AK123B5   XB5AK124B5   XB5AK125B5   XB5AK134G5C0	 Universal for all color heads	1	1	2-position 90° Stay put  ✓	24 ~ (50/60 Hz)	Green	<a href="#">XB5AK123B5</a> <a href="#">(ZB5BW0B15 + ZB5AK1233)</a>	<a href="#">XB5AK123B5C0</a> <a href="#">(ZB5BW0B15 + ZB5AK1233C0)</a>	0.516/1.138						
						Red	<a href="#">XB5AK124B5</a> <a href="#">(ZB5BW0B15 + ZB5AK1243)</a>	<a href="#">XB5AK124B5C0</a> <a href="#">(ZB5BW0B15 + ZB5AK1243C0)</a>	0.516/1.138						
						Orange	<a href="#">XB5AK125B5</a> <a href="#">(ZB5BW0B15 + ZB5AK1253)</a>	<a href="#">XB5AK125B5C0</a> <a href="#">(ZB5BW0B15 + ZB5AK1253C0)</a>	0.516/1.138						
						110...120 ~ (50/60 Hz)	Green	<a href="#">XB5AK123G5</a> <a href="#">(ZB5BW0G15 + ZB5AK1233)</a>	<a href="#">XB5AK123G5C0</a> <a href="#">(ZB5BW0G15 + ZB5AK1233C0)</a>	0.516/1.138					
							Red	<a href="#">XB5AK124G5</a> <a href="#">(ZB5BW0G15 + ZB5AK1243)</a>	<a href="#">XB5AK124G5C0</a> <a href="#">(ZB5BW0G15 + ZB5AK1243C0)</a>	0.516/1.138					
							Orange	<a href="#">XB5AK125G5</a> <a href="#">(ZB5BW0G15 + ZB5AK1253)</a>	<a href="#">XB5AK125G5C0</a> <a href="#">(ZB5BW0G15 + ZB5AK1253C0)</a>	0.516/1.138					
						230...240 ~ (50/60 Hz)	Green	<a href="#">XB5AK123M5</a> <a href="#">(ZB5BW0M15 + ZB5AK1233)</a>	<a href="#">XB5AK123M5C0</a> <a href="#">(ZB5BW0M15 + ZB5AK1233C0)</a>	0.516/1.138					
							Red	<a href="#">XB5AK124M5</a> <a href="#">(ZB5BW0M15 + ZB5AK1243)</a>	<a href="#">XB5AK124M5C0</a> <a href="#">(ZB5BW0M15 + ZB5AK1243C0)</a>	0.516/1.138					
							Orange	<a href="#">XB5AK125M5</a> <a href="#">(ZB5BW0M15 + ZB5AK1253)</a>	<a href="#">XB5AK125M5C0</a> <a href="#">(ZB5BW0M15 + ZB5AK1253C0)</a>	0.516/1.138					
								1	1	3-position ± 45° Stay put  ✓	24 ~ (50/60 Hz)	Green	<a href="#">XB5AK133B5</a> <a href="#">(ZB5BW0B15 + ZB5AK1333)</a>	<a href="#">XB5AK133B5C0</a> <a href="#">(ZB5BW0B15 + ZB5AK1333C0)</a>	0.516/1.138
												Red	<a href="#">XB5AK134B5</a> <a href="#">(ZB5BW0B15 + ZB5AK1343)</a>	<a href="#">XB5AK134B5C0</a> <a href="#">(ZB5BW0B15 + ZB5AK1343C0)</a>	0.516/1.138
												Orange	<a href="#">XB5AK135B5</a> <a href="#">(ZB5BW0B15 + ZB5AK1353)</a>	<a href="#">XB5AK135B5C0</a> <a href="#">(ZB5BW0B15 + ZB5AK1353C0)</a>	0.516/1.138
110...120 ~ (50/60 Hz)	Green	<a href="#">XB5AK133G5</a> <a href="#">(ZB5BW0G15 + ZB5AK1333)</a>	<a href="#">XB5AK133G5C0</a> <a href="#">(ZB5BW0G15 + ZB5AK1333C0)</a>	0.516/1.138											
	Red	<a href="#">XB5AK134G5</a> <a href="#">(ZB5BW0G15 + ZB5AK1343)</a>	<a href="#">XB5AK134G5C0</a> <a href="#">(ZB5BW0G15 + ZB5AK1343C0)</a>	0.516/1.138											
	Orange	<a href="#">XB5AK135G5</a> <a href="#">(ZB5BW0G15 + ZB5AK1353)</a>	<a href="#">XB5AK135G5C0</a> <a href="#">(ZB5BW0G15 + ZB5AK1353C0)</a>	0.516/1.138											
230...240 ~ (50/60 Hz)	Green	<a href="#">XB5AK133M5</a> <a href="#">(ZB5BW0M15 + ZB5AK1333)</a>	<a href="#">XB5AK133M5C0</a> <a href="#">(ZB5BW0M15 + ZB5AK1333C0)</a>	0.516/1.138											
	Red	<a href="#">XB5AK134M5</a> <a href="#">(ZB5BW0M15 + ZB5AK1343)</a>	<a href="#">XB5AK134M5C0</a> <a href="#">(ZB5BW0M15 + ZB5AK1343C0)</a>	0.516/1.138											
	Orange	<a href="#">XB5AK135M5</a> <a href="#">(ZB5BW0M15 + ZB5AK1353)</a>	<a href="#">XB5AK135M5C0</a> <a href="#">(ZB5BW0M15 + ZB5AK1353C0)</a>	0.516/1.138											

(1) For recommended maximum number of contacts constituting the body (fixing collar and contact) associated with the head, see page 26 and 27.

(2) To add customized markings on these references using the web customization tool, see page 5.

## Control and signaling units

Harmony XB5, plastic

Diameter 22 mm Illuminated selector switches with standard handle, with Universal light block

## Illuminated selector switches with standard handle, with Universal light block

(continued) (1)

Shape of head	Type of operator	Positions		Color of handle	Reference		Weight kg/lb	
		Number	Type		For black bezel	For gray bezel		
<b>Heads only (2) (3)</b>								
 ZB5AK1263	Standard handle	2-position	Stay put	↙	White	ZB5AK1213	ZB5AK1213C0	0.016/0.035
					Green	ZB5AK1233	ZB5AK1233C0	0.016/0.035
					Red	ZB5AK1243	ZB5AK1243C0	0.016/0.035
					Orange	ZB5AK1253	ZB5AK1253C0	0.016/0.035
					Yellow	ZB5AK1283	ZB5AK1283C0	0.016/0.035
					Blue	ZB5AK1263	ZB5AK1263C0	0.016/0.035
		Spring return from right to left	↘	White	ZB5AK1413	ZB5AK1413C0	0.017/0.037	
				Green	ZB5AK1433	ZB5AK1433C0	0.017/0.037	
				Red	ZB5AK1443	ZB5AK1443C0	0.017/0.037	
				Orange	ZB5AK1453	ZB5AK1453C0	0.017/0.037	
				Yellow	ZB5AK1483	ZB5AK1483C0	0.017/0.037	
				Blue	ZB5AK1463	ZB5AK1463C0	0.017/0.037	
	3-position ± 45°	Stay put	↘	White	ZB5AK1313	ZB5AK1313C0	0.016/0.035	
				Green	ZB5AK1333	ZB5AK1333C0	0.016/0.035	
				Red	ZB5AK1343	ZB5AK1343C0	0.016/0.035	
				Orange	ZB5AK1353	ZB5AK1353C0	0.016/0.035	
				Yellow	ZB5AK1383	ZB5AK1383C0	0.016/0.035	
				Blue	ZB5AK1363	ZB5AK1363C0	0.016/0.035	
		Spring return to center	↕	White	ZB5AK1513	ZB5AK1513C0	0.016/0.035	
				Green	ZB5AK1533	ZB5AK1533C0	0.016/0.035	
				Red	ZB5AK1543	ZB5AK1543C0	0.016/0.035	
				Orange	ZB5AK1553	ZB5AK1553C0	0.016/0.035	
				Yellow	ZB5AK1583	ZB5AK1583C0	0.016/0.035	
				Blue	ZB5AK1563	ZB5AK1563C0	0.016/0.035	
Spring return from right to center	↘	White	ZB5AK1813	ZB5AK1813C0	0.016/0.035			
		Green	ZB5AK1833	ZB5AK1833C0	0.016/0.035			
		Red	ZB5AK1843	ZB5AK1843C0	0.016/0.035			
		Orange	ZB5AK1853	ZB5AK1853C0	0.016/0.035			
		Yellow	ZB5AK1883	ZB5AK1883C0	0.016/0.035			
		Blue	ZB5AK1863	ZB5AK1863C0	0.016/0.035			
Spring return from left to center	↙	White	ZB5AK1713	ZB5AK1713C0	0.016/0.035			
		Green	ZB5AK1733	ZB5AK1733C0	0.016/0.035			
		Red	ZB5AK1743	ZB5AK1743C0	0.016/0.035			
		Orange	ZB5AK1753	ZB5AK1753C0	0.016/0.035			
		Yellow	ZB5AK1783	ZB5AK1783C0	0.016/0.035			
		Blue	ZB5AK1763	ZB5AK1763C0	0.016/0.035			

(1) For recommended maximum number of contacts constituting the body (fixing collar and contact) associated with the head, see page 26 and 27.

(2) For use with bodies comprising a light source with Universal LED only.

(3) To add customized markings on these references using the web customization tool, see page 5..



ZB5AK1313



ZB5AK1783



# Control and signaling units

## Harmony XB5, plastic

### Diameter 22 mm Pilot lights with Universal LED



XB5AVB1



XB5EVG3

Pilot lights with Universal LED							
Screw clamp terminal connections (Schneider Electric anti-loosening system)							
Shape of head	Supply voltage V	Color	Reference for monolithic units	Reference for complete units	Weight kg/lb		
<b>Complete units (with plain lens)</b>							
	24 ~ (50/60 Hz)	White	<a href="#">XB5EVB1</a>	<a href="#">XB5AVB1</a> ( <a href="#">ZB5AVB1</a> + <a href="#">ZB5AV013</a> )	0.038/0.084		
		Green	<a href="#">XB5EVB3</a>	<a href="#">XB5AVB3</a> ( <a href="#">ZB5AVB1</a> + <a href="#">ZB5AV033</a> )	0.038/0.084		
		Red	<a href="#">XB5EVB4</a>	<a href="#">XB5AVB4</a> ( <a href="#">ZB5AVB1</a> + <a href="#">ZB5AV043</a> )	0.038/0.084		
		Orange	<a href="#">XB5EVB5</a>	<a href="#">XB5AVB5</a> ( <a href="#">ZB5AVB1</a> + <a href="#">ZB5AV053</a> )	0.038/0.084		
		Blue	<a href="#">XB5EVB6</a>	<a href="#">XB5AVB6</a> ( <a href="#">ZB5AVB1</a> + <a href="#">ZB5AV063</a> )	0.038/0.084		
		Yellow	<a href="#">XB5EVB8</a>	–	0.038/0.084		
			110...120 ~ (50/60 Hz)	White	<a href="#">XB5EVG1</a>	<a href="#">XB5AVG1</a> ( <a href="#">ZB5AVG1</a> + <a href="#">ZB5AV013</a> )	0.038/0.084
				Green	<a href="#">XB5EVG3</a>	<a href="#">XB5AVG3</a> ( <a href="#">ZB5AVG1</a> + <a href="#">ZB5AV033</a> )	0.038/0.084
Red	<a href="#">XB5EVG4</a>			<a href="#">XB5AVG4</a> ( <a href="#">ZB5AVG1</a> + <a href="#">ZB5AV043</a> )	0.038/0.084		
Orange	<a href="#">XB5EVG5</a>			<a href="#">XB5AVG5</a> ( <a href="#">ZB5AVG1</a> + <a href="#">ZB5AV053</a> )	0.038/0.084		
Blue	<a href="#">XB5EVG6</a>			<a href="#">XB5AVG6</a> ( <a href="#">ZB5AVG1</a> + <a href="#">ZB5AV063</a> )	0.038/0.084		
Yellow	<a href="#">XB5EVG8</a>			–	0.038/0.084		
	230...240 ~ (50/60 Hz)			White	<a href="#">XB5EVM1</a>	<a href="#">XB5AVM1</a> ( <a href="#">ZB5AVM1</a> + <a href="#">ZB5AV013</a> )	0.038/0.084
				Green	<a href="#">XB5EVM3</a>	<a href="#">XB5AVM3</a> ( <a href="#">ZB5AVM1</a> + <a href="#">ZB5AV033</a> )	0.038/0.084
		Red	<a href="#">XB5EVM4</a>	<a href="#">XB5AVM4</a> ( <a href="#">ZB5AVM1</a> + <a href="#">ZB5AV043</a> )	0.038/0.084		
		Orange	<a href="#">XB5EVM5</a>	<a href="#">XB5AVM5</a> ( <a href="#">ZB5AVM1</a> + <a href="#">ZB5AV053</a> )	0.038/0.084		
		Blue	<a href="#">XB5EVM6</a>	<a href="#">XB5AVM6</a> ( <a href="#">ZB5AVM1</a> + <a href="#">ZB5AV063</a> )	0.038/0.084		
		Yellow	<a href="#">XB5EVM8</a>	–	0.038/0.084		

# Control and signaling units

## Harmony XB5, plastic

### Diameter 22 mm Pilot lights with Universal LED

#### Pilot lights with Universal LED

Screw clamp terminal connections (Schneider Electric anti-loosening system)

##### Heads only, circular (1)

Shape of head	For use with body comprising light source type	Color of lens	Reference	Weight kg/lb
---------------	--	---------------	-----------	--------------

##### ■ With plain lens

		Universal LED	White	<a href="#">ZB5AV013</a>	0.017/0.037
			Green	<a href="#">ZB5AV033</a>	0.017/0.037
			Red	<a href="#">ZB5AV043</a>	0.017/0.037
			Orange	<a href="#">ZB5AV053</a>	0.017/0.037
			Yellow	<a href="#">ZB5AV083</a>	0.017/0.037
			Blue	<a href="#">ZB5AV063</a>	0.017/0.037
			5 colors (2) (3)	<a href="#">ZB5AV003</a>	0.017/0.037



ZB5AV053



ZB5AV083S

##### ■ With plain lens, for insertion of legend (3)

		Universal LED	White	<a href="#">ZB5AV013E</a>	0.017/0.037
			Green	<a href="#">ZB5AV033E</a>	0.017/0.037
			Red	<a href="#">ZB5AV043E</a>	0.017/0.037
			Orange	<a href="#">ZB5AV053E</a>	0.017/0.037
			Yellow	<a href="#">ZB5AV083E</a>	0.017/0.037
			Blue	<a href="#">ZB5AV063E</a>	0.017/0.037

##### ■ With grooved lens (4)

		Universal LED	White	<a href="#">ZB5AV013S</a>	0.017/0.037
			Green	<a href="#">ZB5AV033S</a>	0.017/0.037
			Red	<a href="#">ZB5AV043S</a>	0.017/0.037
			Orange	<a href="#">ZB5AV053S</a>	0.017/0.037
			Yellow	<a href="#">ZB5AV083S</a>	0.017/0.037
			Blue	<a href="#">ZB5AV063S</a>	0.017/0.037



ZB5AV063S

(1) For use with bodies comprising a light source with Universal LED only.

(2) Head supplied with 5 different colored lenses (white, green, red, orange, or blue) not fitted, for insertion of legend.

(3) For legend ordering information, see [page 76](#).

(4) For use in bright ambient light conditions (for example, outdoors in sunlight).

# Control and signaling units

Harmony XB5, plastic

Diameter 22 mm Pilot lights with Universal LED and with BA 9s base fitting



XB5AV5B4

Pilot lights with Universal LED and transformer (1.2 VA, 24 V secondary)				
Screw clamp terminal connections (Schneider Electric anti-loosening system)				
Shape of head	Supply voltage V	Color	Reference (1)	Weight kg/lb
<b>Complete units - With plain lens</b>				
	400 ~ - 50 Hz (1)	White	<a href="#">XB5AV5B1</a>	0.133/0.293
		Green	<a href="#">XB5AV5B3</a>	0.133/0.293
		Red	<a href="#">XB5AV5B4</a>	0.133/0.293
		Orange	<a href="#">XB5AV5B5</a>	0.133/0.293
		Blue	<a href="#">XB5AV5B6</a>	0.133/0.293

Pilot lights with BA 9s base fitting, with plain or grooved lens					
Screw clamp terminal connections (Schneider Electric anti-loosening system)					
Shape of head	Supply voltage V	Color	Reference	Weight kg/lb	
<b>Complete units - With plain lens</b>					
	≤ 250	White	<a href="#">XB5AV61</a> ( <a href="#">ZB5AV6</a> + <a href="#">ZB5AV01</a> )	0.037/0.082	
		Green	<a href="#">XB5AV63</a> ( <a href="#">ZB5AV6</a> + <a href="#">ZB5AV03</a> )	0.037/0.082	
		Red	<a href="#">XB5AV64</a> ( <a href="#">ZB5AV6</a> + <a href="#">ZB5AV04</a> )	0.037/0.082	
		Orange	<a href="#">XB5AV65</a> ( <a href="#">ZB5AV6</a> + <a href="#">ZB5AV05</a> )	0.037/0.082	
		■ Direct supply, for BA 9s bulb, U ≤ 250 V, 2.4 W max. (bulb not included)			
	110...120 ~ - 50/60 Hz	White	<a href="#">XB5AV31</a> ( <a href="#">ZB5AV3</a> + <a href="#">ZB5AV01</a> )	0.109/0.240	
		Green	<a href="#">XB5AV33</a> ( <a href="#">ZB5AV3</a> + <a href="#">ZB5AV03</a> )	0.109/0.240	
		Red	<a href="#">XB5AV34</a> ( <a href="#">ZB5AV3</a> + <a href="#">ZB5AV04</a> )	0.109/0.240	
		Orange	<a href="#">XB5AV35</a> ( <a href="#">ZB5AV3</a> + <a href="#">ZB5AV05</a> )	0.109/0.240	
		■ Via integral transformer, 1.2 VA, 6 V secondary, with BA 9s incandescent bulb (included)			
	230 ~ - 50 Hz 220...240 ~ - 60 Hz	White	<a href="#">XB5AV41</a> ( <a href="#">ZB5AV4</a> + <a href="#">ZB5AV01</a> )	0.110/0.243	
		Green	<a href="#">XB5AV43</a> ( <a href="#">ZB5AV4</a> + <a href="#">ZB5AV03</a> )	0.110/0.243	
		Red	<a href="#">XB5AV44</a> ( <a href="#">ZB5AV4</a> + <a href="#">ZB5AV04</a> )	0.110/0.243	
		Orange	<a href="#">XB5AV45</a> ( <a href="#">ZB5AV4</a> + <a href="#">ZB5AV05</a> )	0.110/0.243	



XB5AV63



XB5AV34



ZB5AV01

Heads only (2)				
Shape of head	For use with body comprising light source type	Color of lens	Reference	Weight kg/lb
■ With plain lens				
	With BA 9s base fitting	White	<a href="#">ZB5AV01</a>	0.018/0.040
		Green	<a href="#">ZB5AV03</a>	0.018/0.040
		Red	<a href="#">ZB5AV04</a>	0.018/0.040
		Orange	<a href="#">ZB5AV05</a>	0.018/0.040
		Blue	<a href="#">ZB5AV06</a>	0.018/0.040
		Clear	<a href="#">ZB5AV07</a>	0.018/0.040
		■ With grooved lens (3)		
	With BA 9s base fitting	White	<a href="#">ZB5AV01S</a>	0.017/0.037
		Green	<a href="#">ZB5AV03S</a>	0.017/0.037
		Red	<a href="#">ZB5AV04S</a>	0.017/0.037
		Orange	<a href="#">ZB5AV05S</a>	0.017/0.037
		Blue	<a href="#">ZB5AV06S</a>	0.017/0.037
		Clear	<a href="#">ZB5AV07S</a>	0.017/0.037

(1) To order 440...460 V ~ - 60 Hz transformer blocks, replace "5" in the reference with "8". For example, XB5AV5B1 becomes XB5AV8B1. To order 550...600 V ~ - 60 Hz blocks, replace "5" with "9". For example, XB5AV5B1 becomes XB5AV9B1.

(2) For use with bodies comprising a light source with BA 9s base fitting (incandescent, neon, or LED) only.

(3) For use in bright ambient light conditions (for example, outdoors in sunlight).

## Control and signaling units

Harmony XB5, plastic

Diameter 22 mm 3-phase pilot light with Universal LED

Push-to-test pilot lights



XB5EV57K4



XB5EV57L4



XB5AW21B5



XB5AW25G5

## 3-phase pilot lights with Universal LED

Faston connector, 6.3 mm

Shape of head	Supply voltage V	Color	Reference	Weight kg/lb
<b>Complete units - With plain lens</b>				
	400 ~ - 50/60 Hz	Red Green Yellow	<a href="#">XB5EV57K4</a>	0.065/0.143
	400 ~ - 50/60 Hz	White White White	<a href="#">XB5EV57L4</a>	0.065/0.143

Push-to-test pilot light <sup>(1)</sup>

Shape of head	Supply voltage V	Color	Reference	Weight kg/lb
<b>Complete units</b>				
	24 ~ - 50/60 Hz	White	<a href="#">XB5AW21B5</a>	0.047/0.104
	24 ~ - 50/60 Hz	Green	<a href="#">XB5AW23B5</a>	0.047/0.104
	24 ~ - 50/60 Hz	Red	<a href="#">XB5AW24B5</a>	0.047/0.104
	24 ~ - 50/60 Hz	Orange	<a href="#">XB5AW25B5</a>	0.047/0.104
	24 ~ - 50/60 Hz	Yellow	<a href="#">XB5AW28B5</a>	0.047/0.104
	24 ~ - 50/60 Hz	Blue	<a href="#">XB5AW26B5</a>	0.047/0.104
	110 - 120 ~ - 50/60 Hz	White	<a href="#">XB5AW21G5</a>	0.047/0.104
	110 - 120 ~ - 50/60 Hz	Green	<a href="#">XB5AW23G5</a>	0.047/0.104
	110 - 120 ~ - 50/60 Hz	Red	<a href="#">XB5AW24G5</a>	0.047/0.104
	110 - 120 ~ - 50/60 Hz	Orange	<a href="#">XB5AW25G5</a>	0.047/0.104
	110 - 120 ~ - 50/60 Hz	Yellow	<a href="#">XB5AW28G5</a>	0.047/0.104
	110 - 120 ~ - 50/60 Hz	Blue	<a href="#">XB5AW26G5</a>	0.047/0.104



(1) For use with bodies comprising a light source with Universal LED only.

# Control and signaling units

Harmony XB5, plastic

Diameter 22 mm Specific functions

Pushbuttons for manual overload reset, potentiometers



XB5AA801

Manual overload reset buttons (travel 10 mm/0.349 in.)					
Shape of head	Actuation distance mm/in.	Marking	Color	Reference	Weight kg/lb
<b>Without cap (1)</b>					
	17...120/ 0.669...4.724	–	–	<a href="#">XB5AA801</a>	0.027/0.060
<b>With flush push</b>					
	17...120/ 0.669...4.724	Without	Green	<a href="#">XB5AA831</a>	0.027/0.060
			Red	<a href="#">XB5AA841</a>	0.027/0.060
			Blue	<a href="#">XB5AA861</a>	0.027/0.060
		O	Red	<a href="#">XB5AA84101</a>	0.027/0.060
		R	Blue	<a href="#">XB5AA86102</a>	0.027/0.060
<b>With projecting push</b>					
	17...120/ 0.669...4.724	O	Red	<a href="#">XB5AL84101</a>	0.027/0.060



XB5AD912R1K



XB5AD912R1K

Complete potentiometer			
Description	Resistance k Ω	Reference	Weight kg/lb
+/-10% linear mode precision complete potentiometer with screw terminals	1	<a href="#">XB5AD912R1K</a>	0.048/0.106
	4.7	<a href="#">XB5AD912R4K7</a>	0.048/0.106
	10	<a href="#">XB5AD912R10K</a>	0.048/0.106
	47	<a href="#">XB5AD912R47K</a>	0.048/0.106
	100	<a href="#">XB5AD912R100K</a>	0.048/0.106
	470	<a href="#">XB5AD912R470K</a>	0.048/0.106

Heads and mounting base for potentiometer (2)				
Shape of head	Description	For use with	Reference	Weight kg/lb
	For potentiometer with shaft length 45 to 50 mm/ 1.772 to 1.968 in.	Ø 6 mm/ 0.236 in. shaft	<a href="#">ZB5AD912</a>	0.032/0.071
		Ø 6.35 mm/ 0.250 in. shaft	<a href="#">ZB5AD922</a>	0.032/0.071

(1) Colored cap to be ordered separately (see page 68).

(2) Potentiometer not included.

## Control and signaling units

Harmony XB5, plastic

Diameter 22 mm Specific functions

Timers, Hour counters, Annunciators



XB5DTB22

Timers								
Description	Output type	Supply voltage V	Time delay type	Time delay range	Reference	Weight kg/lb		
Panel-mounted timer function with status LED and 1 static output in 22.5 mm/0.886 in. hole	1 static output	24 $\overline{\sim}$	Type A (delay on energization)	0.5...10s	<a href="#">XB5DTB22</a>	0.027/0.060		
				3...60 s	<a href="#">XB5DTB23</a>	0.027/0.060		
				0.5...10 min	<a href="#">XB5DTB24</a>	0.027/0.060		
				3...60 min	<a href="#">XB5DTB25</a>	0.027/0.060		
				100...240 $\overline{\sim}$ - 50/60 Hz	Type A (delay on energization)	0.5...10s	<a href="#">XB5DTGM2</a>	0.027/0.060
				3...60 s		<a href="#">XB5DTGM3</a>	0.027/0.060	
	0.5...10 min	<a href="#">XB5DTGM4</a>	0.027/0.060					
	3...60 min	<a href="#">XB5DTGM5</a>	0.027/0.060					



XB5DSB

Hour counters			
Characteristics	Supply voltage V	Reference	Weight kg/lb
Indication 0...9999.9	12...24 $\overline{\sim}$ - 50 or 60 Hz	<a href="#">XB5DSB</a>	0.045/0.099
	120 $\sim$ - 60 Hz	<a href="#">XB5DSG</a>	0.045/0.099
	230...240 $\sim$ - 50 Hz	<a href="#">XB5DSM (1)</a>	0.045/0.099



XB5KS2B4

Annunciators (IP66, IP67, and IP69)				
Characteristics	Supply voltage V	Color	Reference	Weight kg/lb
Continuous or intermittent non-illuminated buzzer - 90dB, 6.8kHz	24 $\overline{\sim}$ - 50 or 60 Hz	-	<a href="#">XB5KSB</a>	0.024/0.053
	110...120 V $\overline{\sim}$ - 50 or 60 Hz	-	<a href="#">XB5KSG</a>	0.024/0.053
	230...240 $\sim$ - 50 or 60 Hz	-	<a href="#">XB5KSM</a>	0.024/0.053
Continuous or intermittent illuminated buzzer - 90dB, 6.8kHz	24 $\overline{\sim}$ - 50 or 60 Hz	Red	<a href="#">XB5KS2B4</a>	0.024/0.053
	110...120 V $\overline{\sim}$ - 50 or 60 Hz	Red	<a href="#">XB5KS2G4</a>	0.024/0.053
	230...240 $\sim$ - 50 or 60 Hz	Red	<a href="#">XB5KS2M4</a>	0.024/0.053
	24V $\overline{\sim}$ - 50 or 60 Hz	Yellow	<a href="#">XB5KS2B8</a>	0.024/0.053
	110...120 V $\overline{\sim}$ - 50 or 60 Hz	Yellow	<a href="#">XB5KS2G8</a>	0.024/0.053
	230...240 $\sim$ - 50 or 60 Hz	Yellow	<a href="#">XB5KS2M8</a>	0.024/0.053

(1) To order a 60 Hz hour counter, add a suffix 6. The reference XB5DSM becomes XB5DSM6.

## Control and signaling units

Harmony XB5, plastic

Diameter 22 mm Specific functions

USB and RJ45 ports, Fuse carrier, Basic Displays



XB5PUSB3



XB5PRJ45



ZB5SKR01



XB5DT1S



XBH1AA0G4



XBH1AA0R4

## USB and RJ45 ports

Description	Interface type	Connection type	Degree of protection	Reference	Weight kg/lb
Panel-mounted USB and RJ45 ports in 22.5 mm/0.886 in. hole with notch	USB interface, jack type A	USB port 3.0 A-A	IP20  IP65, IP67, IP69K with protection cover (1)	<a href="#">XB5PUSB3</a>	0.017/0.037
	Ethernet interface, RJ45 jack	RJ45 port Cat. 6	IP20  IP65, IP67, IP69K with protection cover (1)	<a href="#">XB5PRJ45</a>	0.027/0.060

## RFID operator interface

Description	Set of	Supply Voltage V	Reference	Weight kg/lb
RFID Reader with key holder	1	24V	<a href="#">ZB5SKR01</a>	0.153/0.337
User tag with 2 master key and 2 reset key	10		<a href="#">ZB5SKT01</a>	0.108/0.238

## Fuse carrier

Description	For use with	Reference	Weight kg/lb
Fuse carrier	5 x 20 mm/0.197 x 0.787 in. fuse 6.3 A - 250 V	<a href="#">XB5DT1S</a>	0.022/0.049

## Basic Displays

Description	Input current range	LED color	Reference	Weight kg/lb
Digital panel meter LED display, 1 current input, -999...9999	4...20 mA	Green	<a href="#">XBH1AA0G4</a>	0.032/0.070
		Red	<a href="#">XBH1AA0R4</a>	0.032/0.070

(1) For protection covers, see [page 77](#).

# Control and signaling units

Harmony XB5, plastic

Diameter 22 mm Specific functions

Joystick controllers



ZD5PA12

**Joystick controllers** (with 54 mm/2.126 in. long operating shaft) (1)  
**Screw clamp terminal connections** (Schneider Electric anti-loosening system)

Description	Operation	Spring return to zero position	Reference	Weight kg/lb
<b>Sub-assemblies for joystick controllers</b>				
2-direction	1 notch 1 NO contact per direction	Without	<a href="#">XD5PA12</a>	0.060/0.132
		With	<a href="#">XD5PA22</a>	0.060/0.132
4-direction	1 notch 1 NO contact per direction	Without	<a href="#">XD5PA14</a>	0.077/0.170
		With	<a href="#">XD5PA24</a>	0.077/0.170

**Other versions** Joystick controllers and complete body/contact assemblies for joystick controllers with Faston connector terminals (6.35 or 2 x 2.8/0.250 or 2 x 0.110 in.) Please contact our Customer Care Center.



ZD5PA103

**Joystick controllers** (with 54 mm/2.126 in. long operating shaft) (1)  
**Screw clamp terminal connections** (Schneider Electric anti-loosening system)

Description	For use with	Spring return to zero position	Reference	Weight kg/lb
<b>Sub-assemblies for joystick controllers</b>				
Complete body/contact assemblies	2-direction	-	<a href="#">ZD5PA103</a>	0.049/0.108
	4-direction	-	<a href="#">ZD5PA203</a>	0.058/0.128
Complete head assemblies with operating shaft	2-direction, stay put	-	<a href="#">ZD5PA12</a>	0.022/0.049
	2-direction, spring return to zero position	-	<a href="#">ZD5PA22</a>	0.022/0.049
	4-direction, stay put	-	<a href="#">ZD5PA14</a>	0.022/0.049
	4-direction, spring return to zero position	-	<a href="#">ZD5PA24</a>	0.022/0.049

**Other versions** Joystick controllers and complete body/contact assemblies for joystick controllers with Faston connector terminals (6.35 or 2 x 2.8/0.250 or 2 x 0.110 in.) Please contact our Customer Care Center.



ZD5PA203

(1) Must not be used with standard contact blocks ZBE10● (single) or ZBE20● (double).

## Control and signaling units

Harmony XB5, plastic

Diameter 22 mm Accessories for heads

Unmarked pushbutton caps



ZBA4

## Pushbutton caps, unmarked

Description	For use with	Type of push	Color	Sold in lots of	Unit reference	Weight kg/lb
<b>For plastic pushbuttons</b>						
Caps for plastic pushbuttons, unmarked	ZBABA0 and ZB5AA0 circular pushbutton heads supplied without cap	Flush	White	10	ZBA1	0.001/0.002
			Black	10	ZBA2	0.001/0.002
			Green	10	ZBA3	0.001/0.002
			Red	10	ZBA4	0.001/0.002
			Yellow	10	ZBA5	0.001/0.002
			Blue	10	ZBA6	0.001/0.002



ZBAF9

## For flush mounted plastic pushbuttons (2)

Caps for flush mounted plastic pushbuttons, unmarked	ZB5FA0 circular pushbutton heads supplied without cap	Flush	White	10	ZBAF1	0.001/0.002
			Black	10	ZBAF2	0.001/0.002
			Green	10	ZBAF3	0.001/0.002
			Red	10	ZBAF4	0.001/0.002
			Yellow	10	ZBAF5	0.001/0.002
			Blue	10	ZBAF6	0.001/0.002
			6 colors (1)	1	ZBAF9	0.006/0.013

(1) Set of 6 different colored caps: white, black, green, red, yellow, or blue.

(2) To add customized markings on these references using the web customization tool, see [page 5](#).

## Control and signaling units

Harmony XB5, plastic

Diameter 22 mm Accessories for heads

Pushbutton caps with markings



ZBA333

Pushbutton caps, with markings (3)						
For use with	Type of push	Marking		Color of cap	Unit reference	Weight kg/lb
		Text	Color			
<b>Plastic pushbuttons</b>						
ZB4BA0 and ZB5AA0 circular pushbutton heads supplied without cap (sold in lots of 10)	Flush	I (1)	White	Green	ZBA331	0.001/0.002
			Black	White	ZBA131	0.001/0.002
		II	White	Green	ZBA336	0.001/0.002
		START (1)	White	Green	ZBA333	0.001/0.002
		UP (1)	Black	White	ZBA343	0.001/0.002
		DOWN (1)	White	Black	ZBA344	0.001/0.002
		Ⓣ (1)	White	Black	ZBA245	0.001/0.002
			Black	White	ZBA145	0.001/0.002
		↑ (2)	White	Black	ZBA335	0.001/0.002
			Black	White	ZBA334	0.001/0.002
		O (1)	White	Red	ZBA432	0.001/0.002
			Black		ZBA232	0.001/0.002
		STOP (1)	White	Red	ZBA434	0.001/0.002
			Black		ZBA234	0.001/0.002
		OFF	White	Red	ZBA435	0.001/0.002
		⚠	White	Green	ZBA346	0.001/0.002
		R (1)	White	Blue	ZBA639	0.001/0.002
		+	White	Black	ZBA2934	0.001/0.002
		-	White	Black	ZBA2935	0.001/0.002

(1) Double injection molded marking.

(2) Can be clipped in at 90° steps, through 360°.

(3) To add customized markings on these references using the web customization tool, see [page 5](#).

## Control and signaling units

Harmony XB5, plastic

Diameter 22 mm Accessories for heads

Boots, Lens caps



ZBP0

## Transparent boots for pushbuttons (1)

Description	For use with plastic pushbuttons	Sold in lots of	Unit reference	Weight kg/lb
Single boots (2)	Flush with circular head	10	ZBPA	0.002/0.004
	Projecting with circular head and push-push version	10	ZBP0	0.002/0.004
	Flush or projecting with circular head for food industry applications	10	ZBP0A	0.002/0.004

## Colored boots

Description	Color	For use with	Sold in lots of	Unit reference	Weight kg/lb
Colored boots (can be replaced without dismantling the head)	White	ZB5AP1S	10	-	0.003/0.007
	Black	ZB5AP2S	10	ZBP012	0.003/0.007
	Green	ZB5AP3S	10	ZBP013	0.003/0.007
	Red	ZB5AP4S	10	ZBP014	0.003/0.007
	Yellow	ZB5AP5S	10	ZBP015	0.003/0.007
	Blue	ZB5AP6S	10	ZBP016	0.003/0.007
Clear membrane	Transparent	ZB5AP●83	10	ZBP017	0.003/0.007

## Lens caps

For use with	Color	Sold in lots of	Unit reference	Weight kg/lb
<b>Circular lens caps for light sources with Universal LED</b>				
Pilot lights	White	10	ZBV0113	0.002/0.004
	Green	10	ZBV0133	0.002/0.004
	Red	10	ZBV0143	0.002/0.004
	Orange	10	ZBV0153	0.002/0.004
	Blue	10	ZBV0163	0.002/0.004
<b>Circular lens caps for light sources with BA 9s fitting</b>				
Pilot lights	White	10	ZBV011	0.002/0.004
	Green	10	ZBV013	0.002/0.004
	Red	10	ZBV014	0.002/0.004
	Orange	10	ZBV015	0.002/0.004
	Blue	10	ZBV016	0.002/0.004
	Clear	10	ZBV017	0.002/0.004



ZBV0153



ZBV016

(1) For boots for multiple-headed pushbuttons, see page 38.

(2) Permissible panel thickness 1 to 5 mm/0.039 to 0.179 in., cannot be used with legend holders.

## Control and signaling units

Harmony XB5, plastic

Diameter 22 mm 8 x 27 mm legends with 30 x 40 mm legend holders



ZBZ34



ZBY•H101

30 x 40 mm legend holders (flush mounting with bezel) for 8 x 27 mm legends <sup>(1)</sup>

Description	Legend		Sold in lots of	Unit reference		Weight kg/lb
	Background color	Marking				
Without legend	–	–	10	ZBZ34	–	0.003/0.007
With blank legend	Black or red	–	10	ZBY2H101	–	0.004/0.009
	White or yellow	–	10	ZBY4H101	–	0.004/0.009

Standard 30 x 40 mm legend holders for 8 x 27 mm legends <sup>(1)</sup>

Description	Legend		Sold in lots of	Unit reference		Weight kg/lb
	Color	Marking		For black bezel	For gray bezel <sup>(4)</sup>	
Without legend	–	–	10	ZBZ32	ZBZ32C0	0.001/0.002
With blank legend (for engraving)	Black or red	–	10	ZBY2101	ZBY2101C0	0.002/0.004
	White or yellow	–	10	ZBY4101	ZBY4101C0	0.002/0.004
With 8 x 27 mm/ 0.315 x 1.063 in. legend (with international marking)	Black or red (2)	I	10	ZBY2147	–	0.002/0.004
		O-I	10	ZBY2178	ZBY2178C0	0.002/0.004
		I-II	10	ZBY2179	–	0.002/0.004
		I-O-II	10	ZBY2186	ZBY2186C0	0.002/0.004
		STOP	10	ZBY2304	ZBY2304C0	0.002/0.004
With 8 x 27 mm/ 0.315 x 1.063 in. legend (with French language marking)	Black or red (2)	ARRET (red background)	10	ZBY2104	ZBY2104C0	0.002/0.004
		ARRET-MARCHE	10	ZBY2166	ZBY2166C0	0.002/0.004
		AUTO-MAIN	10	ZBY2164	–	0.002/0.004
		AUTO-O-MAIN	10	ZBY2185	–	0.002/0.004
		DEFAULT (black background)	10	ZBY2134	–	0.002/0.004
		DEFAULT (red background)	10	ZBY2135	–	0.002/0.004
		DESCENTE	10	ZBY2108	–	0.002/0.004
		EN SERVICE	10	ZBY2111	–	0.002/0.004
		FERMETURE	10	ZBY2114	–	0.002/0.004
		MARCHE	10	ZBY2103	ZBY2103C0	0.002/0.004
		MONTEE	10	ZBY2107	–	0.002/0.004
		OUVERTURE	10	ZBY2113	–	0.002/0.004
		REARMEMENT (red background)	10	ZBY2123	–	0.002/0.004
		REARMEMENT (black background)	10	ZBY0123	–	0.002/0.004
		SOUS TENSION	10	ZBY2126	–	0.002/0.004
Red	ARRET D'URGENCE	10	ZBY2130 <sup>(3)</sup>	–	0.002/0.004	

(1) For legends, see page 75.

(2) "Start" functions: white letters on black background. "Stop" functions: white letters on red background (unless otherwise specified above).

(3) For compliance with standard EN/ISO 13850, paragraph 4.4.6, the Emergency Stop function logo  has been added.

(4) To add customized markings on these references using the web customization tool, see page 5.



ZBZ32



ZBY2101



ZBY2104C0



ZBY4140



ZBY2107

# Control and signaling units

Harmony XB5, plastic

Diameter 22 mm 8 x 27 mm legends with 30 x 40 mm legend holders

Standard 30 x 40 mm legend holders with 8 x 27 mm legends <sup>(1)</sup> (continued)							
Description	Legend		Sold in lots of	Reference		Weight kg/lb	
	Color	Marking		For black bezel	For gray bezel <sup>(3)</sup>		
With legend (with English language marking)	Black or red background <sup>(1)</sup>	AUTO-HAND	10	ZBY2364	–	0.002/0.004	
		AUTO-O-HAND	10	ZBY2385	–	0.002/0.004	
		CLOSE	10	ZBY2314	–	0.002/0.004	
		FORWARD	10	ZBY2305	–	0.002/0.004	
		OFF	10	ZBY2312	–	0.002/0.004	
		OFF-ON	10	ZBY2367	ZBY2367C0	0.002/0.004	
		ON	10	ZBY2311	–	0.002/0.004	
		OPEN	10	ZBY2313	–	0.002/0.004	
		POWER ON	10	ZBY2326	–	0.002/0.004	
		RESET (red background)	10	ZBY2323	–	0.002/0.004	
		RESET (black background)	10	ZBY2322	–	0.002/0.004	
		REVERSE	10	ZBY2306	–	0.002/0.004	
		RUN	10	ZBY2334	–	0.002/0.004	
		START	10	ZBY2303	ZBY2303C0	0.002/0.004	
		STOP-START	10	ZBY2366	–	0.002/0.004	
		Red background	EMERGENCY STOP	10	ZBY2330 <sup>(2)</sup>	–	0.002/0.004
	With legend (with German language marking)	Black or red background <sup>(1)</sup>	AUTO-HAND	10	ZBY2364	–	0.002/0.004
			AUTO-O-HAND	10	ZBY2385	–	0.002/0.004



ZBY2303



ZBY2228

<sup>(1)</sup> "Start" functions: white letters on black background. "Stop" functions: white letters on red background (unless otherwise specified above).

<sup>(2)</sup> For compliance with standard EN/ISO 13850, paragraph 4.4.6, the Emergency Stop function logo  has been added.

<sup>(3)</sup> To add customized markings on these references using the web customization tool, see page 5.

## Control and signaling units

Harmony XB5, plastic

Diameter 22 mm 30 x 40 mm legend plates



ZBYP2101



ZBYM2303

## Standard 30 x 40 mm legend plates

Description	Marking (2)	Sold in lots of	Unit Reference		Weight kg/lb
			For black bezel	For gray bezel (1)	
<b>Legend plate, plastic</b>	-	10	ZBYP2101	ZBYP2101C0	0.001/0.002
	O-I	10	ZBYP2178	ZBYP2178C0	0.001/0.002
	STOP	10	ZBYP2304	ZBYP2304C0	0.001/0.002
	START	10	ZBYP2303	ZBYP2303C0	0.001/0.002
	MARCHE	10	ZBYP2103	ZBYP2103C0	0.001/0.002
	I-O-II	10	ZBYP2186	ZBYP2186C0	0.001/0.002
	OFF-ON	10	ZBYP2367	ZBYP2367C0	0.001/0.002
	ARRET-MARCHE	10	ZBYP2166	ZBYP2166C0	0.001/0.002
	ARRET	10	ZBYP2104	ZBYP2104C0	0.001/0.002
<b>Legend plate, metal</b>	-	10	ZBYM2101	-	0.004/0.009
	O-I	10	ZBYM2178	-	0.004/0.009
	STOP	10	ZBYM2304	-	0.004/0.009
	START	10	ZBYM2303	-	0.004/0.009
	MARCHE	10	ZBYM2103	-	0.004/0.009
	I-O-II	10	ZBYM2186	-	0.004/0.009
	OFF-ON	10	ZBYM2367	-	0.004/0.009
	ARRET-MARCHE	10	ZBYM2166	-	0.004/0.009
	ARRET	10	ZBYM2104	-	0.004/0.009

(1) To add customized markings on these references through web customization tool, see [page 5](#).

(2) Black marking for metal references, white marking for standard references.

# Control and signaling units

Harmony XB5, plastic

Diameter 22 mm Legend holders for 18 x 27 mm legends, 18 x 27 mm legends for engraving



ZBZ33

Standard 30 x 50 mm legend holders for 18 x 27 mm legends					
Description	Background color	Sold in lots of	Unit reference		Weight kg/lb
			For black bezel	For gray bezel (1)	
Without legend	–	10	ZBZ33	ZBZ33C0	0.001/0.002
With blank legend	Black or red	10	ZBY6101	ZBY6101C0	0.002/0.004
	White or yellow	10	ZBY6102	ZBY6102C0	0.002/0.004



ZBY6101

30 x 50 mm legend holder (flush mounting with bezel) for 18 x 27 mm legends					
Description	Background color	Sold in lots of	Unit reference		Weight kg/lb
			For black bezel	For gray bezel (1)	
Without legend	–	10	ZBZ35	–	0.003/0.007
With blank legend	Black or red	10	ZBY6H101	–	0.004/0.009
	White or yellow	10	ZBY6H102	–	0.004/0.009



ZBYP6101



ZBYM6101

30 x 50 mm legend plates						
Description	Language	Marking	Sold in lots of	Unit reference		Weight kg/lb
				For black bezel	For gray bezel (1)	
Legend plate, plastic	–	–	10	ZBYP6101	ZBYP6101C0	0.001/0.002
Legend plate, metal	–	–	10	ZBYM6101	–	0.006/0.013



ZBZ35



ZBY6H10

18 x 27 mm legends for engraving for 30 x 50 mm legend holders						
Description	Language	Marking	Sold in lots of	Unit reference		Weight kg/lb
				For black bezel	For gray bezel (1)	
Black or red background	–	Without	10	ZBY5101	–	0.001/0.002
White or yellow background	–	Without	10	ZBY5102	–	0.001/0.002

18 x 27 mm legends for engraving for 30 x 50 mm legend holders					
Description	For use with	Sold in lots of	Unit reference		Weight kg/lb
			For black bezel	For gray bezel (1)	
Sheet of 40 18 x 27 mm/ 0.709 x 1.063 in. legends	30 x 50 mm/ 1.181 x 1.968 in. legend holder ZBZ33 and ZBZ35	10	ZBY5100	–	0.044/0.097

(1) To add customized markings on these references using the web customization tool, see page 5.

## Control and signaling units

Harmony XB5, plastic

Diameter 22 mm, Legends 8 x 27 mm



ZBY0101



ZBY02304

## 8 x 27 mm marked legends for 30 x 40 mm legend holders ZBZ32 and ZBZ34

Language	Background color	Marking	Sold in lots of	Reference	Weight kg/lb
Without	Black or red	–	10	ZBY0101 (3)	0.001/0.002
	White or yellow	–	10	ZBY0102 (3)	0.001/0.002
International	Black or red (1)	O-I	10	ZBY02178	0.001/0.002
		STOP	10	ZBY02304	0.001/0.002
French	Black or red (1)	AUTO-O-MAIN	10	ZBY02185	0.001/0.002
		MARCHE	10	ZBY02103	0.001/0.002
		SOUS TENSION	10	ZBY02126	0.001/0.002

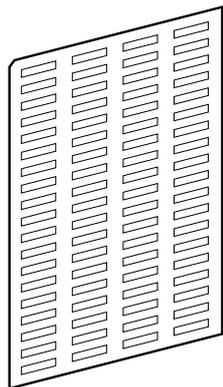

ZBY4100

## Sheets of peel-off legends (with backing board and protective transparent cover)

Description	For use with	Sold in lots of	Unit reference	Weight kg/lb
Sheet of 76 legends Ø 8 x 27 mm/ 0.315 x 1.063 in.	Ø 30 x 40 mm/1.181 x 1.575 in. legend holder ZBZ32 and ZBZ34	10	ZBY4100	0.043/0.095

(1) "Start" functions: white letters on black background. "Stop" functions: white letters on red background (unless otherwise specified above).

(2) For compliance with standard EN/ISO 13850, paragraph 4.4.6, the Emergency Stop function logo  has been added.

(3) To add customized markings on these references using the web customization tool, see [page 5](#).

## Control and signaling units

Harmony XB5, plastic

Diameter 22 mm Legends for insertion, printing, or pre-printed, circular

Bellows for harsh environments

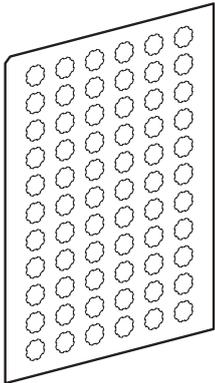

ZBY1101

### Legends for XB5A pushbuttons, illuminated pushbuttons, and pilot lights

Description	Language	Marking	Sold in lots of	Unit reference	Weight kg/lb
Sheets of 66 circular peel-off, transparent, self-adhesive legends	–	Without	10	ZBY1101	0.017/0.037
Strips of 66 circular peel-off, transparent, self-adhesive legends	International	I	10	ZBY1147	0.017/0.037

# Control and signaling units

## Harmony XB5, plastic

### Diameter 22 mm Accessories for pushbuttons

## Other accessories (continued)

Description	For use with	Color	Sold in lots of	Unit reference		Weight kg/lb
				For black bezel	For gray bezel	
<b>Plastic blanking plug</b> (with fixing nut)	Circular Ø 22 mm/0.866 in. control and signaling units	Black	10	ZB5SZ3	ZB5SZ3C0 (1)	0.009/0.020
		Black	10	ZB5SZ5	–	0.009/0.020
<b>Liquid spray protective washer</b> to be fitted under the head	Ø 22 mm/0.866 in. control and signaling units	Chromium plated	10	ZB4BZ007	–	0.010/0.022
		Black	10	ZB4BZ0077	–	0.010/0.022
<b>Plastic protection cover IP65/IP67</b>	Ø 22 mm/0.866 in. USB and RJ45 ports	Black	10	ZBSP1	–	0.002/0.004
<b>Rigid plastic protection cover IP65/IP67</b>	Ø 22 mm/0.866 in. USB and RJ45 ports	Transparent	1	ZBSP2	–	0.006/0.013
<b>Metal protection cover IP65/IP67/IP69K</b>	Ø 22 mm/0.866 in. USB and RJ45 ports	Silver	1	ZBSP3	–	0.010/0.022
<b>Ø 30 mm/1.181 in. plastic flush mounting kit</b>	Pushbuttons and pilot lights	Black	1	ZB5AZ021	–	0.006/0.013
	Selector switches and illuminated pushbuttons	Black	1	ZB5AZ022	–	0.007/0.015
<b>Ø 30 mm/1.181 in. plastic flush mounting kit with 1-line legend</b>	Pushbuttons and pilot lights	Black	1	ZB5AZ023	–	0.007/0.015
	Selector switches and illuminated pushbuttons	Black	1	ZB5AZ024	–	0.008/0.018
<b>Ø 30 mm/1.181 in. plastic flush mounting kit with 2-line legend</b>	Pushbuttons and pilot lights	Black	1	ZB5AZ025	–	0.007/0.015
	Selector switches and illuminated pushbuttons	Black	1	ZB5AZ026	–	0.009/0.020



ZB5SZ3



ZBSP2



ZB5AZ026

(1) To add customized markings on these references using the web customization tool, see [page 5](#).

# Harmony XB5 Flush mounted, Ø 30 mm

## Control and signaling units

Harmony XB5, plastic

Flush mounted Diameter 30 mm, spring return pushbuttons, unmarked

Flush mounted pushbuttons with flush push for Ø 30 mm <sup>(1)</sup>								
Screw clamp terminal connections (Schneider Electric anti-loosening system)								
Shape of head	Type of push	Type of contact		Marking on bezel Text (color)	Color of push	Reference		Weight kg/lb
		NO	NC			For black bezel	For gray bezel	

Complete units <sup>(2)</sup>

	Flush	1	-	-	White	<b>XB5FA11</b> (ZB5AZ101 + ZB5FA1)	<b>XB5FA11C0</b> (ZB5AZ101 + ZB5FA1C0)	0.037/0.082
					Black	<b>XB5FA21</b> (ZB5AZ101 + ZB5FA2)	<b>XB5FA21C0</b> (ZB5AZ101 + ZB5FA2C0)	0.037/0.082
					Green	<b>XB5FA31</b> (ZB5AZ101 + ZB5FA3)	<b>XB5FA31C0</b> (ZB5AZ101 + ZB5FA3C0)	0.037/0.082
					Yellow	<b>XB5FA51</b> (ZB5AZ101 + ZB5FA5)	<b>XB5FA51C0</b> (ZB5AZ101 + ZB5FA5C0)	0.037/0.082
					Blue	<b>XB5FA61</b> (ZB5AZ101 + ZB5FA6)	<b>XB5FA61C0</b> (ZB5AZ101 + ZB5FA6C0)	0.037/0.082
					Red	<b>XB5FA42</b> (ZB5AZ102 + ZB5FA4)	<b>XB5FA42C0</b> (ZB5AZ102 + ZB5FA4C0)	0.037/0.082

Heads only, circular <sup>(2)</sup>

	Without cap <sup>(3)</sup>		-	-	White	<b>ZB5FA0</b>	<b>ZB5FA0C0</b>	0.022/0.049
	Flush, with set of 6 colored caps		-	-	6 colors <sup>(4)</sup>	<b>ZB5FA9</b>	<b>ZB5FA9C0</b>	0.027/0.060
	Flush		-	-	White	<b>ZB5FA1</b>	<b>ZB5FA1C0</b>	0.018/0.040
					Black	<b>ZB5FA2</b>	<b>ZB5FA2C0</b>	0.018/0.040
					Green	<b>ZB5FA3</b>	<b>ZB5FA3C0</b>	0.018/0.040
					Red	<b>ZB5FA4</b>	<b>ZB5FA4C0</b>	0.018/0.040
					Yellow	<b>ZB5FA5</b>	<b>ZB5FA5C0</b>	0.018/0.040
					Blue	<b>ZB5FA6</b>	<b>ZB5FA6C0</b>	0.018/0.040
					Gray	<b>ZB5FA8</b>	<b>ZB5FA8C0</b>	0.018/0.040
					Blue	<b>ZB5FA68</b>	<b>ZB5FA68C0</b>	0.018/0.040
	Flush with transparent cap for insertion of legend <sup>(5)</sup>		-	-	White	<b>ZB5FA18</b>	<b>ZB5FA18C0</b>	0.018/0.040
					Green	<b>ZB5FA38</b>	<b>ZB5FA38C0</b>	0.018/0.040
					Red	<b>ZB5FA48</b>	<b>ZB5FA48C0</b>	0.018/0.040
					Yellow	<b>ZB5FA58</b>	<b>ZB5FA58C0</b>	0.018/0.040
					Blue	<b>ZB5FA68</b>	<b>ZB5FA68C0</b>	0.018/0.040

## Heads only with marked bezel

	Flush		"START" (White)	Green	<b>ZB5FA3M33</b>	-	0.018/0.040
---	-------	--	--------------------	-------	------------------	---	-------------

Flush mounted pushbutton with recessed push for Ø 30 mm <sup>(1)</sup> High guard

Shape of head	Type of push	Color	Reference		Weight kg/lb
			For black bezel	For gray bezel	

Heads only, circular <sup>(2)</sup>

	Recessed (high guard)		White	<b>ZB5FA16</b>	<b>ZB5FA16C0</b>	0.020/0.044
			Black	<b>ZB5FA26</b>	<b>ZB5FA26C0</b>	0.020/0.044
			Green	<b>ZB5FA36</b>	<b>ZB5FA36C0</b>	0.020/0.044
			Red	<b>ZB5FA46</b>	<b>ZB5FA46C0</b>	0.020/0.044
			Yellow	<b>ZB5FA56</b>	<b>ZB5FA56C0</b>	0.020/0.044
			Blue	<b>ZB5FA66</b>	<b>ZB5FA66C0</b>	0.020/0.044

(1) For recommended maximum number of contacts constituting the body (fixing collar and contact) associated with the head, see [page 26](#) and [27](#).(2) To add customized markings on these references using the web customization tool, see [page 5](#).(3) Colored cap to be ordered separately, see [page 94](#).

(4) Head supplied with 6 different colored caps (white, black, green, red, yellow, or blue) not fitted.

(5) For legend ordering information, see [page 98](#).

# Control and signaling units

Harmony XB5, plastic

Diameter 30 mm Flush mounted spring return pushbuttons, unmarked

Flush mounted pushbuttons with projecting push for Ø 30 mm (1)								
Screw clamp terminal connections (Schneider Electric anti-loosening system)								
Shape of head	Type of push	Type of contact		Marking on bezel Text (color)	Color of push	Reference		Weight kg/lb
		NO	NC			For black bezel	For gray bezel	

**Complete units (2)**

	Projecting	–	1		Red	<a href="#">XB5FL42</a> ( <a href="#">ZB5AZ102</a> + <a href="#">ZB5FL4</a> )	<a href="#">XB5FL42C0</a> ( <a href="#">ZB5AZ102</a> + <a href="#">ZB5FL4C0</a> )	0.038/0.084
---	------------	---	---	--	-----	--	--	-------------



XB5FL42



XB5FL42C0

**Heads only, circular (2)**

	Projecting				White	<a href="#">ZB5FL1</a>	–	0.019/0.042
---	------------	--	--	--	-------	------------------------	---	-------------

					Black	<a href="#">ZB5FL2</a>	<a href="#">ZB5FL2C0</a>	0.019/0.042
---	--	--	--	--	-------	------------------------	--------------------------	-------------

					Green	<a href="#">ZB5FL3</a>	<a href="#">ZB5FL3C0</a>	0.019/0.042
--	--	--	--	--	-------	------------------------	--------------------------	-------------

					Red	<a href="#">ZB5FL4</a>	<a href="#">ZB5FL4C0</a>	0.019/0.042
--	--	--	--	--	-----	------------------------	--------------------------	-------------

					Yellow	<a href="#">ZB5FL5</a>	<a href="#">ZB5FL5C0</a>	0.019/0.042
--	--	--	--	--	--------	------------------------	--------------------------	-------------

					Blue	<a href="#">ZB5FL6</a>	<a href="#">ZB5FL6C0</a>	0.019/0.042
--	--	--	--	--	------	------------------------	--------------------------	-------------



ZB5FL4

**Heads only with marked bezel**

	Projecting			"STOP" (White)	Red	<a href="#">ZB5FL4M34</a>	–	0.019/0.042
---	------------	--	--	-------------------	-----	---------------------------	---	-------------



ZB5FL4M34

(1) For recommended maximum number of contacts constituting the body (fixing collar and contact) associated with the head, see [page 26](#) and [27](#).

(2) To add customized markings on these references using the web customization tool, see [page 5](#).

# Control and signaling units

Harmony XB5, plastic  
Diameter 30 mm Flush mounted spring return  
pushbuttons, with marking



XB5FA4322



XB5FA3341C0



ZB5FA331



ZB5FA432



ZB5FL232

Flush mounted pushbuttons with flush or projecting push for Ø 30 mm <sup>(1)</sup>								
Screw clamp terminal connections (Schneider Electric anti-loosening system)								
Shape of head	Type of push	Type of contact		Marking Text (color)	Color of push	Reference		Weight kg/lb
		NO	NC			For black bezel	For gray bezel	
<b>Complete units <sup>(2)</sup></b>								
	Flush	1	–	"I" (white)	Green	<a href="#">XB5FA3311</a> ( <a href="#">ZB5AZ101</a> + <a href="#">ZB5FA331</a> )	<a href="#">XB5FA3311C0</a> ( <a href="#">ZB5AZ101</a> + <a href="#">ZB5FA331C0</a> )	0.037/0.082
	Flush	–	1	"O" (white)	Red	<a href="#">XB5FA4322</a> ( <a href="#">ZB5AZ102</a> + <a href="#">ZB5FA432</a> )	<a href="#">XB5FA4322C0</a> ( <a href="#">ZB5AZ102</a> + <a href="#">ZB5FA432C0</a> )	0.037/0.082
	Projecting	–	1	"O" (white)	Red	<a href="#">XB5FL4322</a> ( <a href="#">ZB5AZ102</a> + <a href="#">ZB5FL432</a> )	–	0.037/0.082
	Flush (3)	1	–	↑ (black)	White	<a href="#">XB5FA3341</a> ( <a href="#">ZB5AZ101</a> + <a href="#">ZB5FA334</a> )	<a href="#">XB5FA3341C0</a> ( <a href="#">ZB5AZ101</a> + <a href="#">ZB5FA334C0</a> )	0.037/0.082
	Flush (3)	1	–	↓ (white)	Black	<a href="#">XB5FA3351</a> ( <a href="#">ZB5AZ101</a> + <a href="#">ZB5FA335</a> )	<a href="#">XB5FA3351C0</a> ( <a href="#">ZB5AZ101</a> + <a href="#">ZB5FA335C0</a> )	0.037/0.082
<b>Heads only, circular <sup>(2)</sup></b>								
	Flush			"I" (white)	Green	<a href="#">ZB5FA331</a>	<a href="#">ZB5FA331C0</a>	0.018/0.040
				"I" (black)	White	<a href="#">ZB5FA131</a>	–	0.018/0.040
				"II" (white)	Green	<a href="#">ZB5FA336</a>	–	0.018/0.040
				"II" (black)	White	<a href="#">ZB5FA136</a>	–	0.018/0.040
				"START" (white)	Green	<a href="#">ZB5FA333</a>	–	0.018/0.040
				"START" (black)	White	<a href="#">ZB5FA133</a>	–	0.018/0.040
				"ON" (white)	Green	<a href="#">ZB5FA341</a>	–	0.018/0.040
				"ON" (black)	White	<a href="#">ZB5FA141</a>	–	0.018/0.040
				"MARCHE" (white)	Green	<a href="#">ZB5FA342</a>	–	0.018/0.040
				"MARCHE" (black)	White	<a href="#">ZB5FA142</a>	–	0.018/0.040
					Black	<a href="#">ZB5FA245</a>	–	0.018/0.040
					White	<a href="#">ZB5FA145</a>	–	0.018/0.040
				"O" (white)	Red	<a href="#">ZB5FA432</a>	<a href="#">ZB5FA432C0</a>	0.018/0.040
				"O" (white)	Black	<a href="#">ZB5FA232</a>	–	0.018/0.040
				"ARRET" (white)	Red	<a href="#">ZB5FA433</a>	–	0.018/0.040
				"ARRET" (white)	Black	<a href="#">ZB5FA233</a>	–	0.018/0.040
				"STOP" (white)	Red	<a href="#">ZB5FA434</a>	<a href="#">ZB5FA434C0</a>	0.018/0.040
				"STOP" (white)	Black	<a href="#">ZB5FA234</a>	–	0.018/0.040
				"OFF" (white)	Red	<a href="#">ZB5FA435</a>	–	0.018/0.040
				"OFF" (white)	Black	<a href="#">ZB5FA235</a>	–	0.018/0.040
			UP (black)	White	<a href="#">ZB5FA343</a>	–	0.018/0.040	
			DOWN (white)	Black	<a href="#">ZB5FA344</a>	–	0.018/0.040	
			↑ (black) (2)	White	<a href="#">ZB5FA334</a>	<a href="#">ZB5FA334C0</a>	0.018/0.040	
			↓ (white) (2)	Black	<a href="#">ZB5FA335</a>	<a href="#">ZB5FA335C0</a>	0.018/0.040	
<b>Heads only, circular <sup>(2)</sup></b>								
	Projecting (3)			"O" (white)	Red	<a href="#">ZB5FL432</a>	<a href="#">ZB5FL432C0</a>	0.019/0.042
				"O" (white)	Black	<a href="#">ZB5FL232</a>	–	0.019/0.042
				"ARRET" (white)	Red	<a href="#">ZB5FL433</a>	–	0.019/0.042
				"STOP" (white)	Red	<a href="#">ZB5FL434</a>	–	0.019/0.042
				"STOP" (white)	Black	<a href="#">ZB5FL234</a>	–	0.019/0.042
				"OFF" (white)	Red	<a href="#">ZB5FL435</a>	–	0.019/0.042
			"OFF" (white)	Black	<a href="#">ZB5FL235</a>	–	0.019/0.042	

(1) For recommended maximum number of contacts constituting the body (fixing collar and contact) associated with the head, see page 26 and 27.

(2) To add customized markings on these references using the web customization tool, see page 5

(3) Product supplied with cap not clipped in, allowing orientation through 360° in 90° steps.

# Control and signaling units

Harmony XB5, plastic  
Diameter 30 mm Flush mounted illuminated pushbuttons, spring return, with Universal LED



XB5FW31B5



XB5FW34G5

Flush mounted illuminated pushbuttons with flush push for Ø 30 mm <sup>(1)</sup>								
Screw clamp terminal connections (Schneider Electric anti-loosening system)								
Shape of head	Description	Type of contact		Supply voltage V	Color of push	Reference		Weight kg/lb
		NO	NC			For black bezel	For gray bezel	
<b>Complete units - With plain lens <sup>(2)</sup></b>								
	Universal LED	1	1	24 ~ 50/60 Hz	White	<b>XB5FW31B5</b> (ZB5AW0B15 + ZB5FW313)	<b>XB5FW31B5C0</b> (ZB5AW0B15 + ZB5FW313C0)	0.056/0.123
					Green	<b>XB5FW33B5</b> (ZB5AW0B15 + ZB5FW333)	<b>XB5FW33B5C0</b> (ZB5AW0B15 + ZB5FW333C0)	0.056/0.123
					Red	<b>XB5FW34B5</b> (ZB5AW0B15 + ZB5FW343)	<b>XB5FW34B5C0</b> (ZB5AW0B15 + ZB5FW343C0)	0.056/0.123
					Orange	<b>XB5FW35B5</b> (ZB5AW0B15 + ZB5FW353)	<b>XB5FW35B5C0</b> (ZB5AW0B15 + ZB5FW353C0)	0.056/0.123
					Blue	<b>XB5FW36B5</b> (ZB5AW0B15 + ZB5FW363)	<b>XB5FW36B5C0</b> (ZB5AW0B15 + ZB5FW363C0)	0.056/0.123
				110...120 ~ 50/60 Hz	White	<b>XB5FW31G5</b> (ZB5AW0G15 + ZB5FW313)	<b>XB5FW31G5C0</b> (ZB5AW0G15 + ZB5FW313C0)	0.056/0.123
					Green	<b>XB5FW33G5</b> (ZB5AW0G15 + ZB5FW333)	<b>XB5FW33G5C0</b> (ZB5AW0G15 + ZB5FW333C0)	0.056/0.123
					Red	<b>XB5FW34G5</b> (ZB5AW0G15 + ZB5FW343)	<b>XB5FW34G5C0</b> (ZB5AW0G15 + ZB5FW343C0)	0.056/0.123
					Orange	<b>XB5FW35G5</b> (ZB5AW0G15 + ZB5FW353)	<b>XB5FW35G5C0</b> (ZB5AW0G15 + ZB5FW353C0)	0.056/0.123
					Blue	<b>XB5FW36G5</b> (ZB5AW0G15 + ZB5FW363)	<b>XB5FW36G5C0</b> (ZB5AW0G15 + ZB5FW363C0)	0.056/0.123
				230...240 ~ 50/60 Hz	White	<b>XB5FW31M5</b> (ZB5AW0M15 + ZB5FW313)	<b>XB5FW31M5C0</b> (ZB5AW0M15 + ZB5FW313C0)	0.056/0.123
					Green	<b>XB5FW33M5</b> (ZB5AW0M15 + ZB5FW333)	<b>XB5FW33M5C0</b> (ZB5AW0M15 + ZB5FW333C0)	0.056/0.123
					Red	<b>XB5FW34M5</b> (ZB5AW0M15 + ZB5FW343)	<b>XB5FW34M5C0</b> (ZB5AW0M15 + ZB5FW343C0)	0.056/0.123
					Orange	<b>XB5FW35M5</b> (ZB5AW0M15 + ZB5FW353)	<b>XB5FW35M5C0</b> (ZB5AW0M15 + ZB5FW353C0)	0.056/0.123
					Blue	<b>XB5FW36M5</b> (ZB5AW0M15 + ZB5FW363)	<b>XB5FW36M5C0</b> (ZB5AW0M15 + ZB5FW363C0)	0.056/0.123

(1) For recommended maximum number of contacts constituting the body (fixing collar and contact) associated with the head, see page 26 and 27.

(2) To add customized markings on these references using the web customization tool, see page 5.

## Control and signaling units

Harmony XB5, plastic

Diameter 30 mm Flush mounted illuminated pushbuttons, spring return, with Universal LED



ZB5FW313



ZB5FW333C0



ZB5FW343C0



ZB5FW933

Flush mounted illuminated pushbuttons with flush push for Ø 30 mm (continued) <sup>(1)</sup>					
Shape of head	Type of push	Color	Reference		Weight kg/lb
			For black bezel	For gray bezel	
<b>Heads only, circular <sup>(2)</sup> - With plain lens <sup>(3)</sup></b>					
	Flush	White	ZB5FW313	ZB5FW313C0	0.017/0.037
		Green	ZB5FW333	ZB5FW333C0	0.017/0.037
		Red	ZB5FW343	ZB5FW343C0	0.017/0.037
		Orange	ZB5FW353	ZB5FW353C0	0.017/0.037
		Yellow	ZB5FW383	ZB5FW383C0	0.017/0.037
		Blue	ZB5FW363	ZB5FW363C0	0.017/0.037
	Flush with illuminated ring	White	ZB5FW913	–	0.016/0.035
		Green	ZB5FW933	–	0.016/0.035
		Red	ZB5FW943	–	0.016/0.035
		Orange	ZB5FW953	–	0.016/0.035
		Yellow	ZB5FW983	–	0.016/0.035
		Blue	ZB5FW963	–	0.016/0.035
	Flush for insertion of legend <sup>(4)</sup> (IP69 K)	White	ZB5FA18	ZB5FA18C0	0.018/0.040
		Green	ZB5FA38	ZB5FA38C0	0.018/0.040
		Red	ZB5FA48	ZB5FA48C0	0.018/0.040
		Orange	ZB5FA58	ZB5FA58C0	0.018/0.040
		Blue	ZB5FA68	ZB5FA68C0	0.018/0.040

UN  
Universal  
for all color heads

UN  
Universal  
for all color heads

UN  
Universal  
for all color heads

(1) For recommended maximum number of contacts constituting the body (fixing collar and contact) associated with the head, see [page 26](#) and [27](#).

(2) For use with bodies comprising a light source with Universal LED only.

(3) To add customized markings on these references using the web customization tool, see [page 5](#).

(4) For legend ordering information, see [page 99](#).

## Control and signaling units

Harmony XB5, plastic

Diameter 30 mm Flush mounted illuminated pushbuttons, spring return, with Universal LED

Flush mounted illuminated pushbuttons with projecting push for Ø 30 mm <sup>(1)</sup>					
Shape of head	Type of push	Color	Reference		Weight kg/lb
			For black bezel	For gray bezel	
<b>Heads only, circular - With plain lens <sup>(2)</sup></b>					
	Projecting	White	ZB5FW113	ZB5FW113C0	0.018/0.040
		Green	ZB5FW133	ZB5FW133C0	0.018/0.040
		Red	ZB5FW143	ZB5FW143C0	0.018/0.040
		Orange	ZB5FW153	ZB5FW153C0	0.018/0.040
		Yellow	ZB5FW183	ZB5FW183C0	0.018/0.040
		Blue	ZB5FW163	ZB5FW163C0	0.018/0.040

(1) For recommended maximum number of contacts constituting the body (fixing collar and contact) associated with the head, see [page 26](#) and [27](#).

(2) To add customized markings on these references using the web customization tool, see [page 5](#).

## Control and signaling units

Harmony XB5, plastic

Diameter 30 mm Flush mounted pushbuttons, push-push



ZB5FH04

Flush mounted pushbuttons with flush push for Ø 30 mm <sup>(1)</sup>					
Shape of head	Type of push	Color of push	Reference		Weight kg/lb
			For black bezel	For gray bezel	
<b>Heads only, circular <sup>(3)</sup></b>					
	Without cap <sup>(2)</sup>	–	ZB5FH0	ZB5FH0C0	0.018/0.040
	Flush	White	ZB5FH01	ZB5FH01C0	0.018/0.040
		Black	ZB5FH02	ZB5FH02C0	0.018/0.040
		Green	ZB5FH03	ZB5FH03C0	0.018/0.040
		Red	ZB5FH04	ZB5FH04C0	0.018/0.040
		Yellow	ZB5FH05	ZB5FH05C0	0.018/0.040
		Blue	ZB5FH06	ZB5FH06C0	0.018/0.040z

Flush mounted pushbuttons with projecting push for Ø 30 mm <sup>(1)</sup>					
Shape of head	Type of push	Color of push	Reference		Weight kg/lb
			For black bezel	For gray bezel	
<b>Heads only, circular <sup>(3)</sup></b>					
	Projecting	White	ZB5FH1	ZB5FH1C0	0.018/0.040
		Black	ZB5FH2	ZB5FH2C0	0.018/0.040
		Green	ZB5FH3	ZB5FH3C0	0.018/0.040
		Red	ZB5FH4	ZB5FH4C0	0.018/0.040
		Yellow	ZB5FH5	ZB5FH5C0	0.018/0.040
		Blue	ZB5FH6	ZB5FH6C0	0.018/0.040



ZB5FH5C0

(1) For recommended maximum number of contacts constituting the body (fixing collar and contact) associated with the head, see [page 26 and 27](#).

(2) Caps to be ordered separately, see [page 94](#).

(3) To add customized markings on these references using the web customization tool, see [page 5](#).

## Control and signaling units

Harmony XB5, plastic

Diameter 30 mm Flush mounted pushbuttons, push-push



ZB5FH063



Flush mounted illuminated pushbuttons with flush push for Ø 30 mm <sup>(1)</sup>					
Shape of head	Type of push	Color of push	Reference		Weight kg/lb
			For black bezel	For gray bezel	
Heads only, circular <sup>(2)</sup> <sup>(3)</sup>					
	Flush	White	ZB5FH013	ZB5FH013C0	0.017/0.037
		Green	ZB5FH033	ZB5FH033C0	0.017/0.037
		Red	ZB5FH043	ZB5FH043C0	0.017/0.037
		Orange	ZB5FH053	ZB5FH053C0	0.017/0.037
		Yellow	ZB5FH083	ZB5FH083C0	0.017/0.037
		Blue	ZB5FH063	ZB5FH063C0	0.017/0.037



ZB5FH83C0



Flush mounted illuminated pushbuttons with projecting push for Ø 30 mm <sup>(1)</sup>					
Shape of head	Type of push	Color of push	Reference		Weight kg/lb
			For black bezel	For gray bezel	
Heads only, circular <sup>(2)</sup> <sup>(3)</sup>					
	Projecting	White	ZB5FH13	ZB5FH13C0	0.017/0.037
		Green	ZB5FH33	ZB5FH33C0	0.017/0.037
		Red	ZB5FH43	ZB5FH43C0	0.017/0.037
		Orange	ZB5FH53	ZB5FH53C0	0.017/0.037
		Yellow	ZB5FH83	ZB5FH83C0	0.017/0.037
		Blue	ZB5FH63	ZB5FH63C0	0.017/0.037

(1) For recommended maximum number of contacts constituting the body (fixing collar and contact) associated with the head, see [page 26](#) and [27](#).

(2) For use with bodies comprising a light source with universal LED only.

(3) To add customized markings on these references using the web customization tool, see [page 5](#).

## Control and signaling units

Harmony XB5, plastic

Diameter 30 mm Flush mounted selector switches with standard handle

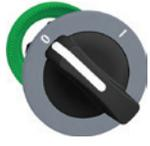
Flush mounted selector switches with standard handle for Ø 30 mm <sup>(1)</sup>									
Screw clamp terminal connections (Schneider Electric anti-loosening system)									
Shape of head operator	Type of contact	Marking on bezel	Positions	Reference	Weight				
	NO	NC	Number	Type		kg/lb	For black bezel	For gray bezel	
<b>Complete units <sup>(2)</sup></b>									
	Standard handle, black	1	–	2-position 90°	Stay put	0.043/0.095	<b>XB5FD21</b> ( <b>ZB5AZ101</b> + <b>ZB5FD2</b> )	<b>XB5FD21C0</b> ( <b>ZB5AZ101</b> + <b>ZB5FD2C0</b> )	
		1	–		Spring return from right to left	0.046/0.101	<b>XB5FD41</b> ( <b>ZB5AZ101</b> + <b>ZB5FD4</b> )	<b>XB5FD41C0</b> ( <b>ZB5AZ101</b> + <b>ZB5FD4C0</b> )	
		1	1		Stay put	0.043/0.095	<b>XB5FD25</b> ( <b>ZB5AZ105</b> + <b>ZB5FD2</b> )	<b>XB5FD25C0</b> ( <b>ZB5AZ105</b> + <b>ZB5FD2C0</b> )	
		2	–	3-position ± 45°	Stay put	0.043/0.095	<b>XB5FD33</b> ( <b>ZB5AZ103</b> + <b>ZB5FD3</b> )	<b>XB5FD33C0</b> ( <b>ZB5AZ103</b> + <b>ZB5FD3C0</b> )	
					Spring return to center	0.043/0.095	<b>XB5FD53</b> ( <b>ZB5AZ103</b> + <b>ZB5FD5</b> )	<b>XB5FD53C0</b> ( <b>ZB5AZ103</b> + <b>ZB5FD5C0</b> )	
<b>Heads only <sup>(2)</sup></b>									
	Standard handle, black			2-position 90°	Stay put	0.017/0.037	<b>ZB5FD2</b>	<b>ZB5FD2C0</b>	
					Spring return from right to left	0.020/0.044	<b>ZB5FD4</b>	<b>ZB5FD4C0</b>	
				3-position ± 45°	Stay put	0.017/0.037	<b>ZB5FD3</b>	<b>ZB5FD3C0</b>	
					Spring return to center	0.017/0.037	<b>ZB5FD5</b>	<b>ZB5FD5C0</b>	
					Spring return from left to center	0.017/0.037	<b>ZB5FD7</b>	<b>ZB5FD7C0</b>	
					Spring return from right to center	0.017/0.037	<b>ZB5FD8</b>	<b>ZB5FD8C0</b>	
									
<b>Heads only with marked bezel</b>									
	Standard handle, black	"O" and "I" (White)		2-position 90°	Stay put	0.017/0.037	<b>ZB5FD2M178</b>		
<b>Heads only with other colored handles <sup>(2)</sup></b>									
	Standard handle, white				Add suffix <b>01</b> to the reference, for example:		<b>ZB5FD201</b>	<b>ZB5FD201C0</b>	
	Standard handle, green				Add suffix <b>03</b> to the reference, for example:		<b>ZB5FD203</b>	<b>ZB5FD203C0</b>	
	Standard handle, red				Add suffix <b>04</b> to the reference, for example:		<b>ZB5FD204</b>	<b>ZB5FD204C0</b>	
	Standard handle, yellow				Add suffix <b>05</b> to the reference, for example:		<b>ZB5FD205</b>	<b>ZB5FD205C0</b>	
	Standard handle, blue				Add suffix <b>06</b> to the reference, for example:		<b>ZB5FD206</b>	<b>ZB5FD206C0</b>	

(1) For recommended maximum number of contacts and sequence of contacts constituting the body (fixing collar and contact) associated with the head, see [page 26](#) and [27](#).

(2) To add customized markings on these references using the web customization tool, see [page 5](#).

# Control and signaling units

Harmony XB5, plastic

Diameter 30 mm Flush mounted selector switches with long handle

Flush mounted selector switches with long handle for Ø 30 mm <sup>(1)</sup>									
Screw clamp terminal connections (Schneider Electric anti-loosening system)									
Shape of head	Type of operator	Type of contact		Positions Number	Type	Reference		Weight kg/lb	
		NO	NC			For black bezel	For gray bezel		
<b>Complete units <sup>(2)</sup></b>									
	Long handle, black	1	-	2-position 90°	Stay put	✓	<b>XB5FJ21</b> ( <b>ZB5AZ101</b> + <b>ZB5FJ2</b> )	<b>XB5FJ21C0</b> ( <b>ZB5AZ101</b> + <b>ZB5FJ2C0</b> )	0.043/0.095
					Spring return to center	∇	<b>XB5FJ53</b> ( <b>ZB5AZ103</b> + <b>ZB5FJ5</b> )	<b>XB5FJ53C0</b> ( <b>ZB5AZ103</b> + <b>ZB5FJ5C0</b> )	0.043/0.095
					Stay put	∇	<b>XB5FJ33</b> ( <b>ZB5AZ103</b> + <b>ZB5FJ3</b> )	<b>XB5FJ33C0</b> ( <b>ZB5AZ103</b> + <b>ZB5FJ3C0</b> )	0.043/0.095
<b>Heads only <sup>(2)</sup></b>									
	Long handle, black			2-position 90°	Stay put	✓	<b>ZB5FJ2</b>	<b>ZB5FJ2C0</b>	0.017/0.037
					Spring return from right to left	∇	<b>ZB5FJ4</b>	<b>ZB5FJ4C0</b>	0.020/0.044
					Stay put	∇	<b>ZB5FJ3</b>	<b>ZB5FJ3C0</b>	0.017/0.037
					Spring return to center	∇	<b>ZB5FJ5</b>	<b>ZB5FJ5C0</b>	0.017/0.037
					Spring return from left to center	∇	<b>ZB5FJ7</b>	<b>ZB5FJ7C0</b>	0.017/0.037
					Spring return from right to center	∇	<b>ZB5FJ8</b>	<b>ZB5FJ8C0</b>	0.017/0.037

(1) For recommended maximum number of contacts and sequence of contacts constituting the body (fixing collar and contact) associated with the head, see [page 26](#) and [27](#).

(2) To add customized markings on these references using the web customization tool, see [page 5](#).

## Control and signaling units

Harmony XB5, plastic

Diameter 30 mm Flush mounted key switches with key 455

Flush mounted key switches for Ø 30 mm <sup>(1)</sup>											
Screw clamp terminal connections (Schneider Electric anti-loosening system)											
Shape of head	Type of operator	Type of contact		Positions <sup>(2)</sup>		Reference	Reference		Weight kg/lb		
		NO	NC	Number	Type		For black bezel <sup>(4)</sup>	For gray bezel			
<b>Complete units</b>											
	Key switch with key 455	1	–	2-position 90°	Stay put		<a href="#">XB5FG21</a> ( <a href="#">ZB5AZ101</a> + <a href="#">ZB5FG2</a> )	<a href="#">XB5FG21C0</a> ( <a href="#">ZB5AZ101</a> + <a href="#">ZB5FG2C0</a> )	0.831/1.832		
							<a href="#">XB5FG41</a> ( <a href="#">ZB5AZ101</a> + <a href="#">ZB5FG4</a> )	<a href="#">XB5FG41C0</a> ( <a href="#">ZB5AZ101</a> + <a href="#">ZB5FG4C0</a> )	0.831/1.832		
						Spring return to left 	<a href="#">XB5FG61</a> ( <a href="#">ZB5AZ101</a> + <a href="#">ZB5FG6</a> )	<a href="#">XB5FG61C0</a> ( <a href="#">ZB5AZ101</a> + <a href="#">ZB5FG6C0</a> )	0.870/1.918		
	Key switch with key 455	2	–	3-position ± 45°	Stay put		<a href="#">XB5FG03</a> ( <a href="#">ZB5AZ103</a> + <a href="#">ZB5FG0</a> )	<a href="#">XB5FG03C0</a> ( <a href="#">ZB5AZ103</a> + <a href="#">ZB5FG0C0</a> )	0.831/1.832		
							<a href="#">XB5FG33</a> ( <a href="#">ZB5AZ103</a> + <a href="#">ZB5FG3</a> )	<a href="#">XB5FG33C0</a> ( <a href="#">ZB5AZ103</a> + <a href="#">ZB5FG3C0</a> )	0.831/1.832		
<b>Heads only</b>											
	Key switch with key 455 <sup>(3)</sup>	2-position 90°	–	2-position 90°	Stay put		<a href="#">ZB5FG2</a> <sup>(4)</sup>	<a href="#">ZB5FG2C0</a>	0.057/0.126		
							<a href="#">ZB5FG02</a>	–	0.057/0.126		
							<a href="#">ZB5FG4</a> <sup>(4)</sup>	<a href="#">ZB5FG4C0</a>	0.057/0.126		
						Spring return from right to left 	<a href="#">ZB5FG6</a> <sup>(4)</sup>	<a href="#">ZB5FG6C0</a>	0.061/0.134		
						3-position ± 45°	Stay put		<a href="#">ZB5FG0</a> <sup>(4)</sup>	<a href="#">ZB5FG0C0</a>	0.057/0.126
									<a href="#">ZB5FG3</a>	–	0.057/0.126
									<a href="#">ZB5FG5</a>	–	0.057/0.126
									<a href="#">ZB5FG9</a>	–	0.057/0.126
									<a href="#">ZB5FG09</a>	–	0.057/0.126
						Spring return from left to center 	<a href="#">ZB5FG1</a>	–	0.057/0.126		
						Spring return to center 	<a href="#">ZB5FG7</a> <sup>(4)</sup>	<a href="#">ZB5FG7C0</a>	0.057/0.126		
						Spring return from right to center 	<a href="#">ZB5FG8</a>	–	0.057/0.126		
	<a href="#">ZB5FG05</a> <sup>(4)</sup>	<a href="#">ZB5FG05C0</a>	0.057/0.126								
	<a href="#">ZB5FG08</a> <sup>(4)</sup>	<a href="#">ZB5FG08C0</a>	0.057/0.126								

<sup>(1)</sup> For recommended maximum number of contacts and sequence of contacts constituting the body (fixing collar and contact) associated with the head, see [page 26](#) and [27](#).

<sup>(2)</sup> The symbol  indicates key withdrawal position(s).

<sup>(3)</sup> For specific keys, please contact our Customer Care Center.

<sup>(4)</sup> To add customized markings on these references using the web customization tool, see [page 5](#).

# Control and signaling units

Harmony XB5, plastic

Diameter 30 mm Flush mounted key switches with key 8D1

Flush mounted selector switches with knurled knob



ZB5FG09D

Flush mounted key switches for Ø 30 mm (continued) (1)										
Shape of head	Type of operator	Positions (2)			Reference		Weight kg/lb			
		Number	Type		For black bezel	For gray bezel				
	Key switch with key 8D1	2-position 90°	Stay put		ZB5FG2D	–	0.069/0.152			
					ZB5FG02D	–	0.069/0.152			
					ZB5FG4D	–	0.069/0.152			
		3-position ± 45°	Stay put	Spring return from right to left		ZB5FG6D	–	0.069/0.152		
						ZB5FG0D	–	0.069/0.152		
						ZB5FG3D	–	0.069/0.152		
				Spring return from left to center		ZB5FG5D	–	0.069/0.152		
						ZB5FG9D	–	0.069/0.152		
						ZB5FG09D	–	0.069/0.152		
				Spring return from right to center		ZB5FG1D	–	0.069/0.152		
						ZB5FG7D	–	0.069/0.152		
						ZB5FG8D	–	0.069/0.152		
				3-position ± 45°	Stay put	Spring return to centre		ZB5FG05D	–	0.069/0.152
								ZB5FG08D	–	0.069/0.152
								ZB5FG03D	–	0.069/0.152
				3-position ± 45°	Stay put	Spring return from right to centre		ZB5FG04D	–	0.069/0.152
								ZB5FG06D	–	0.069/0.152
									ZB5FG07D	–



ZB5FD29



ZB5FD29C0

Flush mounted selector switches with knurled knob for Ø 30 mm (1)							
Shape of head	Type of operator	Positions (2)			Reference		Weight kg/lb
		Number	Type		For black bezel	For gray bezel	
<b>Heads only (3)</b>							
	Black knurled knob	2-position 90°	Stay put		ZB5FD29	ZB5FD29C0	0.034/0.075
					ZB5FD49	ZB5FD49C0	0.034/0.075
		3-position ± 45°	Stay put		ZB5FD39	ZB5FD39C0	0.034/0.075
					ZB5FD59	ZB5FD59C0	0.034/0.075
					ZB5FD79	ZB5FD79C0	0.034/0.075
					ZB5FD89	ZB5FD89C0	0.034/0.075

(1) For recommended maximum number of contacts and sequence of contacts constituting the body (fixing collar and contact) associated with the head, see page 26 and 27.

(2) The symbol indicates key withdrawal position(s).

(3) To add customized markings on these references using the web customization tool, see page 5.

## Control and signaling units

Harmony XB5, plastic

Diameter 30 mm Flush mounted illuminated selector switches with standard handle, with Universal LED

Flush mounted illuminated selector switches with standard handle, with Universal LED for Ø 30 mm (1)															
Screw clamp terminal connections (Schneider Electric anti-loosening system)															
Shape	Type of head operator	Type of contact		Positions Number and type	Supply voltage V	Color of handle	Reference		Weight kg/lb						
		NO	NC				For black bezel	For gray bezel							
<b>Complete units (2)</b>															
 XB5FK123B5	 Standard handle	1	1	2-position 90° Stay put	24 ~ (50/60 Hz)	Green	<a href="#">XB5FK123B5</a> ( <a href="#">ZB5AW0B15</a> + <a href="#">ZB5FK1233</a> )	<a href="#">XB5FK123B5C0</a> ( <a href="#">ZB5AW0B15</a> + <a href="#">ZB5FK1233C0</a> )	0.516/1.138						
						Red	<a href="#">XB5FK124B5</a> ( <a href="#">ZB5AW0B15</a> + <a href="#">ZB5FK1243</a> )	<a href="#">XB5FK124B5C0</a> ( <a href="#">ZB5AW0B15</a> + <a href="#">ZB5FK1243C0</a> )	0.516/1.138						
						Orange	<a href="#">XB5FK125B5</a> ( <a href="#">ZB5AW0B15</a> + <a href="#">ZB5FK1253</a> )	<a href="#">XB5FK125B5C0</a> ( <a href="#">ZB5AW0B15</a> + <a href="#">ZB5FK1253C0</a> )	0.516/1.138						
										110...120 ~ (50/60 Hz)	Green	<a href="#">XB5FK123G5</a> ( <a href="#">ZB5AW0G15</a> + <a href="#">ZB5FK1233</a> )	<a href="#">XB5FK123G5C0</a> ( <a href="#">ZB5AW0G15</a> + <a href="#">ZB5FK1233C0</a> )	0.516/1.138	
						Red	<a href="#">XB5FK124G5</a> ( <a href="#">ZB5AW0G15</a> + <a href="#">ZB5FK1243</a> )	–	0.516/1.138						
						Orange	<a href="#">XB5FK125G5</a> ( <a href="#">ZB5AW0G15</a> + <a href="#">ZB5FK1253</a> )	–	0.516/1.138						
										230...240 ~ (50/60 Hz)	Green	<a href="#">XB5FK123M5</a> ( <a href="#">ZB5AW0M15</a> + <a href="#">ZB5FK1233</a> )	<a href="#">XB5FK123M5C0</a> ( <a href="#">ZB5AW0M15</a> + <a href="#">ZB5FK1233C0</a> )	0.516/1.138	
						Red	<a href="#">XB5FK124M5</a> ( <a href="#">ZB5AW0M15</a> + <a href="#">ZB5FK1243</a> )	<a href="#">XB5FK124M5C0</a> ( <a href="#">ZB5AW0M15</a> + <a href="#">ZB5FK1243C0</a> )	0.516/1.138						
						Orange	<a href="#">XB5FK125M5</a> ( <a href="#">ZB5AW0M15</a> + <a href="#">ZB5FK1253</a> )	<a href="#">XB5FK125M5C0</a> ( <a href="#">ZB5AW0M15</a> + <a href="#">ZB5FK1253C0</a> )	0.516/1.138						
						 XB5FK124B5	 UN Universal for all color heads	1	1	3-position ±45° Stay put	24 ~ (50/60 Hz)	Green	<a href="#">XB5FK133B5</a> ( <a href="#">ZB5AW0B15</a> + <a href="#">ZB5FK1333</a> )	<a href="#">XB5FK133B5C0</a> ( <a href="#">ZB5AW0B15</a> + <a href="#">ZB5FK1333C0</a> )	0.516/1.138
												Red	<a href="#">XB5FK134B5</a> ( <a href="#">ZB5AW0B15</a> + <a href="#">ZB5FK1343</a> )	–	0.516/1.138
												Orange	<a href="#">XB5FK135B5</a> ( <a href="#">ZB5AW0B15</a> + <a href="#">ZB5FK1353</a> )	–	0.516/1.138
				110...120 ~ (50/60 Hz)	Green							<a href="#">XB5FK133G5</a> ( <a href="#">ZB5AW0G15</a> + <a href="#">ZB5FK1333</a> )	–	0.516/1.138	
Red	<a href="#">XB5FK134G5</a> ( <a href="#">ZB5AW0G15</a> + <a href="#">ZB5FK1343</a> )	–	0.516/1.138												
Orange	<a href="#">XB5FK135G5</a> ( <a href="#">ZB5AW0G15</a> + <a href="#">ZB5FK1353</a> )	–	0.516/1.138												
				230...240 ~ (50/60 Hz)	Green							<a href="#">XB5FK133M5</a> ( <a href="#">ZB5AW0M15</a> + <a href="#">ZB5FK1333</a> )	<a href="#">XB5FK133M5C0</a> ( <a href="#">ZB5AW0M15</a> + <a href="#">ZB5FK1333C0</a> )	0.516/1.138	
Red	<a href="#">XB5FK134M5</a> ( <a href="#">ZB5AW0M15</a> + <a href="#">ZB5FK1343</a> )	–	0.516/1.138												
Orange	<a href="#">XB5FK135M5</a> ( <a href="#">ZB5AW0M15</a> + <a href="#">ZB5FK1353</a> )	–	0.516/1.138												
 XB5FK125B5		1	1	3-position ±45° Stay put	24 ~ (50/60 Hz)							Green	<a href="#">XB5FK133B5</a> ( <a href="#">ZB5AW0B15</a> + <a href="#">ZB5FK1333</a> )	<a href="#">XB5FK133B5C0</a> ( <a href="#">ZB5AW0B15</a> + <a href="#">ZB5FK1333C0</a> )	0.516/1.138
												Red	<a href="#">XB5FK134B5</a> ( <a href="#">ZB5AW0B15</a> + <a href="#">ZB5FK1343</a> )	–	0.516/1.138
												Orange	<a href="#">XB5FK135B5</a> ( <a href="#">ZB5AW0B15</a> + <a href="#">ZB5FK1353</a> )	–	0.516/1.138
										110...120 ~ (50/60 Hz)	Green	<a href="#">XB5FK133G5</a> ( <a href="#">ZB5AW0G15</a> + <a href="#">ZB5FK1333</a> )	–	0.516/1.138	
						Red	<a href="#">XB5FK134G5</a> ( <a href="#">ZB5AW0G15</a> + <a href="#">ZB5FK1343</a> )	–	0.516/1.138						
						Orange	<a href="#">XB5FK135G5</a> ( <a href="#">ZB5AW0G15</a> + <a href="#">ZB5FK1353</a> )	–	0.516/1.138						
										230...240 ~ (50/60 Hz)	Green	<a href="#">XB5FK133M5</a> ( <a href="#">ZB5AW0M15</a> + <a href="#">ZB5FK1333</a> )	<a href="#">XB5FK133M5C0</a> ( <a href="#">ZB5AW0M15</a> + <a href="#">ZB5FK1333C0</a> )	0.516/1.138	
						Red	<a href="#">XB5FK134M5</a> ( <a href="#">ZB5AW0M15</a> + <a href="#">ZB5FK1343</a> )	–	0.516/1.138						
						Orange	<a href="#">XB5FK135M5</a> ( <a href="#">ZB5AW0M15</a> + <a href="#">ZB5FK1353</a> )	–	0.516/1.138						

(1) For recommended maximum number of contacts constituting the body (fixing collar and contact) associated with the head, see page 26 and 27.

(2) To add customized markings on these references using the web customization tool, see page 5.

# Control and signaling units

Harmony XB5, plastic

Diameter 30 mm Flush mounted pilot lights with Universal LED



XB5FVB1



XB5FVB4C0



XB5FVG3

Flush mounted pilot lights with Universal LED for Ø 30 mm <sup>(1)</sup>					
Screw clamp terminal connections (Schneider Electric anti-loosening system)					
Shape of head	Supply voltage V	Color	Reference		Weight kg/lb
			For black bezel	For gray bezel	
<b>Complete units (with plain lens)</b>					
	24 ~ (50/60 Hz)	White	<a href="#">XB5FVB1</a> ( <a href="#">ZB5AVB1</a> + <a href="#">ZB5FV013</a> )	<a href="#">XB5FVB1C0</a> ( <a href="#">ZB5AVB1</a> + <a href="#">ZB5FV013C0</a> )	0.038/0.084
		Green	<a href="#">XB5FVB3</a> ( <a href="#">ZB5AVB1</a> + <a href="#">ZB5FV033</a> )	<a href="#">XB5FVB3C0</a> ( <a href="#">ZB5AVB1</a> + <a href="#">ZB5FV033C0</a> )	0.038/0.084
		Red	<a href="#">XB5FVB4</a> ( <a href="#">ZB5AVB1</a> + <a href="#">ZB5FV043</a> )	<a href="#">XB5FVB4C0</a> ( <a href="#">ZB5AVB1</a> + <a href="#">ZB5FV043C0</a> )	0.038/0.084
		Orange	<a href="#">XB5FVB5</a> ( <a href="#">ZB5AVB1</a> + <a href="#">ZB5FV053</a> )	<a href="#">XB5FVB5C0</a> ( <a href="#">ZB5AVB1</a> + <a href="#">ZB5FV053C0</a> )	0.038/0.084
		Blue	<a href="#">XB5FVB6</a> ( <a href="#">ZB5AVB1</a> + <a href="#">ZB5FV063</a> )	<a href="#">XB5FVB6C0</a> ( <a href="#">ZB5AVB1</a> + <a href="#">ZB5FV063C0</a> )	0.038/0.084
			110...120 ~ (50/60 Hz)	White	<a href="#">XB5FVG1</a> ( <a href="#">ZB5AVG1</a> + <a href="#">ZB5FV013</a> )
Green	<a href="#">XB5FVG3</a> ( <a href="#">ZB5AVG1</a> + <a href="#">ZB5FV033</a> )			<a href="#">XB5FVG3C0</a> ( <a href="#">ZB5AVG1</a> + <a href="#">ZB5FV033C0</a> )	0.038/0.084
Red	<a href="#">XB5FVG4</a> ( <a href="#">ZB5AVG1</a> + <a href="#">ZB5FV043</a> )			<a href="#">XB5FVG4C0</a> ( <a href="#">ZB5AVG1</a> + <a href="#">ZB5FV043C0</a> )	0.038/0.084
Orange	<a href="#">XB5FVG5</a> ( <a href="#">ZB5AVG1</a> + <a href="#">ZB5FV053</a> )			<a href="#">XB5FVG5C0</a> ( <a href="#">ZB5AVG1</a> + <a href="#">ZB5FV053C0</a> )	0.038/0.084
Blue	<a href="#">XB5FVG6</a> ( <a href="#">ZB5AVG1</a> + <a href="#">ZB5FV063</a> )			<a href="#">XB5FVG6C0</a> ( <a href="#">ZB5AVG1</a> + <a href="#">ZB5FV063C0</a> )	0.038/0.084
	230...240 ~ (50/60 Hz)			White	<a href="#">XB5FVM1</a> ( <a href="#">ZB5AVM1</a> + <a href="#">ZB5FV013</a> )
		Green	<a href="#">XB5FVM3</a> ( <a href="#">ZB5AVM1</a> + <a href="#">ZB5FV033</a> )	<a href="#">XB5FVM3C0</a> ( <a href="#">ZB5AVM1</a> + <a href="#">ZB5FV033C0</a> )	0.038/0.084
		Red	<a href="#">XB5FVM4</a> ( <a href="#">ZB5AVM1</a> + <a href="#">ZB5FV043</a> )	<a href="#">XB5FVM4C0</a> ( <a href="#">ZB5AVM1</a> + <a href="#">ZB5FV043C0</a> )	0.038/0.084
		Orange	<a href="#">XB5FVM5</a> ( <a href="#">ZB5AVM1</a> + <a href="#">ZB5FV053</a> )	<a href="#">XB5FVM5C0</a> ( <a href="#">ZB5AVM1</a> + <a href="#">ZB5FV053C0</a> )	0.038/0.084
		Blue	<a href="#">XB5FVM6</a> ( <a href="#">ZB5AVM1</a> + <a href="#">ZB5FV063</a> )	<a href="#">XB5FVM6C0</a> ( <a href="#">ZB5AVM1</a> + <a href="#">ZB5FV063C0</a> )	0.038/0.084

(1) To add customized markings on these references using the web customization tool, see [page 5](#).

## Control and signaling units

Harmony XB5, plastic

Diameter 30 mm Flush mounted pilot lights with  
Universal LED

## Flush mounted pilot lights with Universal LED for Ø 30 mm (continued) (1)

Screw clamp terminal connections (Schneider Electric anti-loosening system)

Heads only, circular (2)

Shape of head	For use with body comprising light source type	Color of lens	Reference		Weight kg/lb
			For black bezel	For gray bezel	
■ With plain lens					
	Universal LED	White	ZB5FV013	ZB5FV013C0	0.017/0.037
		Green	ZB5FV033	ZB5FV033C0	0.017/0.037
		Red	ZB5FV043	ZB5FV043C0	0.017/0.037
		Orange	ZB5FV053	ZB5FV053C0	0.017/0.037
		Yellow	ZB5FV083	ZB5FV083C0	0.017/0.037
		Blue	ZB5FV063	ZB5FV063C0	0.017/0.037



ZB5FV043



ZB5FV083C0

(1) To add customized markings on these references using the web customization tool, see [page 5](#).

(2) For use with bodies comprising a light source with Universal LED only.

## Control and signaling units

Harmony XB5, plastic

Accessories for flush mounted heads

Pushbutton caps with markings



ZBAF331

## Pushbutton caps with markings for flush mounted heads (3)

For use with	Type of push	Marking		Color of cap	Unit reference	Weight kg/lb
		Text	Color			
<b>Plastic pushbuttons</b>						
ZB4FA0 and ZB5FA0 circular pushbutton heads supplied without cap (sold in lots of 10)	Flush	I (1)	White	Green	ZBAF331	0.001/0.002
			Black	White	ZBAF131	0.001/0.002
		II	White	Green	ZBAF336	0.001/0.002
			Black	White	ZBAF136	0.001/0.002
		III	White	Green	ZBAF337	0.001/0.002
			Black	White	ZBAF137	0.001/0.002
		IV	White	Green	ZBAF338	0.001/0.002
			Black	White	ZBAF138	0.001/0.002
START (1)			White	Green	ZBAF333	0.001/0.002
			Black	White	ZBAF133	0.001/0.002
ON			White	Green	ZBAF341	0.001/0.002
			Black	White	ZBAF141	0.001/0.002
MARCHE			White	Green	ZBAF342	0.001/0.002
			Black	White	ZBAF142	0.001/0.002
UP (1)			Black	White	ZBAF343	0.001/0.002
DOWN (1)			White	Black	ZBAF344	0.001/0.002
Ⓣ (1)			White	Black	ZBAF245	0.001/0.002
			Black	White	ZBAF145	0.001/0.002
↑ (2)			White	Black	ZBAF335	0.001/0.002
			Black	White	ZBAF334	0.001/0.002
O (1)			White	Red	ZBAF432	0.001/0.002
				Black	ZBAF232	0.001/0.002
ARRET			White	Red	ZBAF433	0.001/0.002
				Black	ZBAF233	0.001/0.002
STOP (1)			White	Red	ZBAF434	0.001/0.002
				Black	ZBAF234	0.001/0.002
OFF			White	Red	ZBAF435	0.001/0.002
				Black	ZBAF235	0.001/0.002
R (1)			White	Blue	ZBAF639	0.001/0.002
+			White	Black	ZBAF2934	0.001/0.002
-			White	Black	ZBAF2935	0.001/0.002

(1) Double injection molded marking.

(2) Can be clipped in at 90° steps, through 360°.

(3) To add customized markings on these references using the web customization tool, see page 5.

## Other accessories

Description	For use with	Color	Sold in lots of	Unit reference		Weight kg/lb
				For black bezel	For gray bezel	
 <p><b>Plastic blanking plug for flush mounted heads</b> (with fixing nut)</p>	Circular Ø 30 mm/1.181 in. flush mounted control and signaling units	Black	5	<a href="#">ZB5FSZ3</a>	–	0.009/0.020
 <p><b>Metal ring for flush mounted</b> Ø 30 mm/1.181 in. NEMA hole</p>	Ø 30 mm/1.181 in. flush mounted control and signaling units	Chromium plated	10	<a href="#">ZB4FBZ014</a>	–	0.012/0.027
<p><b>Liquid spray protective washer</b> to be fitted under the head</p>	Ø 30 mm/1.181 in. flush mounted control and signaling units	Chromium plated	10	<a href="#">ZB4FBZ007</a>	–	0.003/0.006

# Control and signaling units

Harmony XB5, plastic

Legend holders for flush mounted heads

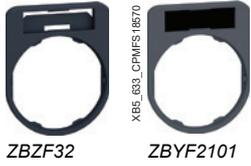

### Standard 40 x 50 mm legend holders for 8 x 27 mm legends - for flush mounted heads

Description	Color	Sold in lots of	Unit reference		Weight kg/lb
			For black bezel	For gray bezel (2)	
Without legend	–	10	ZBZF32	–	0.001/0.002
With blank legend (for engraving)	Black or red	10	ZBYF2101	ZBYF2101C0	0.002/0.004
	White or yellow	10	ZBYF4101	ZBYF4101C0	0.002/0.004
With 8 x 27 mm / 0.315 x 1.063 in. legend (with international marking)	Black or red (1) O-I	10	ZBYF2178	ZBYF2178C0	0.003/0.007
	STOP	10	ZBYF2304	ZBYF2304C0	0.003/0.007
	START (in white)	10	ZBYF2303	ZBYF2303C0	0.003/0.007
	MARCHE	10	ZBYF2103	ZBYF2103C0	0.003/0.007
	I-O-II	10	ZBYF2186	ZBYF2186C0	0.003/0.007
	OFF-ON	10	ZBYF2367	ZBYF2367C0	0.003/0.007
	ARRET-MARCHE	10	ZBYF2166	ZBYF2166C0	0.003/0.007



### Standard 40 x 60 mm legend holders for 18 x 27 mm legends - for flush mounted heads

Description	Color	Sold in lots of	Unit reference		Weight kg/lb
			For black bezel	For gray bezel (2)	
Without legend	–	10	ZBZF33	–	0.001/0.002
With blank legend (for engraving)	Black or red	10	ZBYF6101	ZBYF6101C0	0.002/0.004
	White or yellow	10	ZBYF6102	ZBYF6102C0	0.002/0.004

(1) "Start" functions: white letters on black background. "Stop" functions: white letters on red background (unless otherwise specified above).

(2) To add customized markings on these references using the web customization tool, see page 5.

(3) Black marking for white color plated, white marking for black and gray color plated.

## Control and signaling units

Harmony XB5, plastic

Legend holders for flush mounted heads

## Standard 40 x 50 mm legend plate - for flush mounted heads

Description	Color	Marking (3)	Sold in lots of	Unit reference		Weight kg/lb
				For black bezel	For gray bezel (2)	
Legend plate, plastic	–	–	10	ZBYFP2101	ZBYFP2101C0	0.003/0.007
		O-I	10	ZBYFP2178	ZBYFP2178C0	0.003/0.007
		STOP	10	ZBYFP2304	ZBYFP2304C0	0.003/0.007
		START	10	ZBYFP2303	ZBYFP2303C0	0.003/0.007
		MARCHE	10	ZBYFP2103	ZBYFP2103C0	0.003/0.007
		I-O-II	10	ZBYFP2186	ZBYFP2186C0	0.003/0.007
		OFF-ON	10	ZBYFP2367	ZBYFP2367C0	0.003/0.007
		ARRET-MARCHE	10	ZBYFP2166	ZBYFP2166C0	0.003/0.007
		ARRET	10	ZBYFP2104	ZBYFP2104C0	0.003/0.007



ZBYFP2101



ZBYFP2303

## 40 x 60 mm legend plate - for flush mounted heads

Description	Color	Marking	Sold in lots of	Unit Reference		Weight kg/lb
				For black bezel	For gray bezel (2)	
Legend plate, plastic	–	–	10	ZBYFP6101	ZBYFP6101C0	0.003/0.007

(1) "Start" functions: white letters on black background. "Stop" functions: white letters on red background (unless otherwise specified above).

(2) To add customized markings on these references using the web customization tool, see [page 5](#).

(3) Black marking for white color plated, white marking for black and gray color plated.

## Control and signaling units

Harmony XB5, plastic

Diameter 22 mm, Legends 8 x 27 mm



ZBY0101



ZBY02304

## 8 x 27 mm marked legends for 30 x 40 mm legend holders ZBZ32 and ZBZ34

Language	Background color	Marking	Sold in lots of	Reference	Weight kg/lb
Without	Black or red	–	10	ZBY0101 (3)	0.001/0.002
	White or yellow	–	10	ZBY0102 (3)	0.001/0.002
International	Black or red (1)	O-I	10	ZBY02178	0.001/0.002
		STOP	10	ZBY02304	0.001/0.002
		SOUS TENSION	10	ZBY02126	0.001/0.002
French	Black or red (1)	AUTO-O-MAIN	10	ZBY02185	0.001/0.002
		MARCHE	10	ZBY02103	0.001/0.002

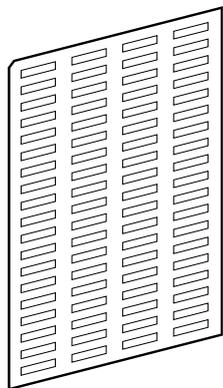

ZBY4100

## Sheets of peel-off legends (with backing board and protective transparent cover)

Description	For use with	Sold in lots of	Unit reference	Weight kg/lb
Sheet of 76 legends Ø 8 x 27 mm/ 0.315 x 1.063 in.	Ø 30 x 40 mm/1.181 x 1.575 in. legend holder ZBZ32 and ZBZ34	10	ZBY4100	0.043/0.095

(1) "Start" functions: white letters on black background. "Stop" functions: white letters on red background (unless otherwise specified above).

(2) For compliance with standard EN/ISO 13850, paragraph 4.4.6, the Emergency Stop function logo  has been added.

(3) To add customized markings on these references using the web customization tool, see [page 5](#).

## Control and signaling units

Harmony XB5, plastic

Diameter 22 mm Legends for insertion, printing, or pre-printed, circular

Bellows for harsh environments

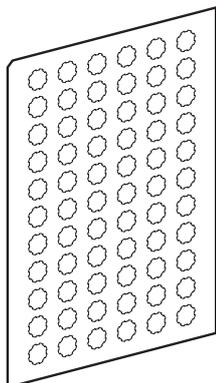

ZBY1101

## Legends for XB5A pushbuttons, illuminated pushbuttons, and pilot lights

Description	Language	Marking	Sold in lots of	Unit reference	Weight kg/lb
Sheets of 66 circular peel-off, transparent, self-adhesive legends	–	Without	10	ZBY1101	0.017/0.037
Strips of 66 circular peel-off, transparent, self-adhesive legends	International	I	10	ZBY1147	0.017/0.037

# Common Components and Accessories

# Control and signaling units

Harmony XB5, plastic

Body/contact assemblies - Screw clamp terminal connections



ZB5AZ009



ZBE101



ZBE203



ZB5AZ101



ZBE201



ZB5AZ107



ZBE501



ZB2BE101

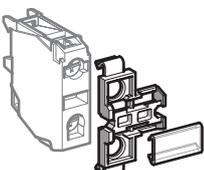

ZBZ001

## Body/fixing collar

For use with	Sold in lots of	Unit reference	Weight kg/lb
Electrical block (contact or light)	10	ZB5AZ009	0.006/0.013

## Contact functions <sup>(1)</sup>

Screw clamp terminal connections (Schneider Electric anti-loosening system)

Application	Type of contact	Description	NO	NC	NC MC(7)	Sold in lots of	Unit reference	Weight kg/lb
-------------	-----------------	-------------	----	----	----------	-----------------	----------------	--------------

### Contacts for standard applications

Contact blocks	Single	Contact blocks	1	–	–	5	ZBE101	0.011/0.024
			–	1	–	5	ZBE102 (6)	0.011/0.024
	Double		–	–	1	5	ZBE302	0.014/0.030
			2	–	–	5	ZBE203	0.020/0.044
			–	2	–	5	ZBE204	0.020/0.044
			1	1	–	5	ZBE205	0.020/0.044
			1	–	–	1	ZB5AZ101	0.021/0.046
	Single with body/fixing collar		–	1	–	1	ZB5AZ102	0.021/0.046
			2	–	–	1	ZB5AZ103	0.030/0.066
			–	2	–	1	ZB5AZ104	0.030/0.066
1			1	–	1	ZB5AZ105	0.030/0.066	
1			2	–	1	ZB5AZ141	0.040/0.088	

### Contacts for specific applications

Low power switching	Single	Standard	1	–	–	5	ZBE1016	0.012/0.026	
			–	1	–	5	ZBE1026	0.012/0.026	
		Dusty environment <sup>(2)</sup> (IP 5X, 50 µm dust)	1	–	–	5	ZBE1016P	0.012/0.026	
			–	1	–	5	ZBE1026P	0.012/0.026	
Staggered contacts	Single	Early make NO	1	–	–	5	ZBE201	0.011/0.024	
			–	1	–	5	ZBE202	0.011/0.024	
		Single with body/fixing collar	Overlapping NO+NC	1	1	–	5	ZB5AZ106	0.062/0.137
			Staggered NO+NO	2	–	–	5	ZB5AZ107	0.062/0.137
			High power switching	Single	Standard <sup>(3)</sup>	1	–	–	1
–	1	–				1	ZBE502	0.020/0.044	
2	–	–				1	ZBE503	0.032/0.071	
–	2	–				1	ZBE504	0.032/0.071	
1	1	–				1	ZBE505	0.032/0.071	
Additional contact blocks for high power switching	Single	Standard <sup>(4)</sup>	1	–	–	1	ZB2BE101	0.020/0.044	
			–	1	–	1	ZB2BE102	0.020/0.044	

## Clip-on legend holder, sheet of blank legends and labelling software

Description	Sold in lots of	Unit reference	Weight kg/lb
Clip-on legend-holder for electrical blocks with screw clamp terminal connections <sup>(5)</sup> . For identification of an XB4B control or signaling unit	10	ZBZ001	0.001/0.002
Sheet of 50 blank legends for legend holder ZBZ001	10	ZBY001	0.023/0.051

<sup>(1)</sup> The contact blocks enable variable composition of body/contact assemblies. Maximum number of rows possible: 3. Either 3 rows of 3 single contacts or 1 row of 3 double contacts + 1 row of 3 single contacts (double contacts occupy the first 2 rows). Maximum number of contacts is specified on 22 of this catalog.

<sup>(2)</sup> It is not possible to fit an additional contact block on the back of these contact blocks.

<sup>(3)</sup> It is not possible to fit an additional contact block on the back of these contact blocks or to use these contacts with light blocks.

<sup>(4)</sup> To be fitted on the back of ZBE50● contacts.

<sup>(5)</sup> This legend holder is not compatible with high power switching contacts.

<sup>(6)</sup> To order products with screw clamp terminal connections for lugs, add a 9 at the end of the commercial reference. Example: ZBE102 becomes ZBE1029.

<sup>(7)</sup> NC contact block with monitoring dedicated for Emergency stop head only.

# Control and signaling units

## Harmony XB5, plastic

### Light blocks - Screw clamp terminal connections



ZBVB1



UN  
Universal  
for all color heads

Light blocks				
Description	Supply voltage V	Sold in lots of	Unit reference	Weight kg/lb
<b>Light blocks with screw clamp terminal connections</b> (Schneider Electric anti-loosening system)				
Universal LED light block	12 ~ (50 or 60 Hz)	5	ZBVJ1	0.017/0.037
	24 ~ (50 or 60 Hz)	5	ZBVB1	0.017/0.037
	24...120 ~ (50 or 60 Hz)	5	ZBVBG1	0.017/0.037
	110...120 ~ (50 or 60 Hz)	5	ZBVG1	0.017/0.037
	230...240 ~ (50 or 60 Hz)	5	ZBVM1	0.017/0.037



ZBVG4T



UN  
Universal  
for all color heads

Light blocks with inductive overload protection				
Description	Supply voltage V	Sold in lots of	Unit reference	Weight kg/lb
Universal LED light block	110...240 V ~ 50/60 Hz	5	ZBVG1T	0.017/0.037

## Control and signaling units

Harmony XB5, plastic

Flashing light blocks, transformer blocks, blocks for “test light”, LED suppressors



ZBV5B



ZBZG156



ZBVM156



ZBZM156

## Flashing light blocks with screw clamp terminal connections

(Schneider Electric anti-loosening system)

Description	Supply voltage V		Sold in lots of	Unit reference	Weight kg/lb
Universal LED light block	24 $\sim$ (50 or 60 Hz)	White	5	ZBV18B1	0.017/0.037
		Green	5	ZBV18B3	0.017/0.037
		Red	5	ZBV18B4	0.017/0.037
		Orange	5	ZBV18B5	0.017/0.037
		Blue	5	ZBV18B6	0.017/0.037
		110...120 $\sim$ (50 or 60 Hz)	White	5	ZBV18G1
	Green	5	ZBV18G3	0.017/0.037	
	Red	5	ZBV18G4	0.017/0.037	
	Orange	5	ZBV18G5	0.017/0.037	
	Blue	5	ZBV18G6	0.017/0.037	
230...240 $\sim$ (50 or 60 Hz)	White	5	ZBV18M1	0.017/0.037	
		Green	5	ZBV18M3	0.017/0.037
		Red	5	ZBV18M4	0.017/0.037
		Orange	5	ZBV18M5	0.017/0.037
		Blue	5	ZBV18M6	0.017/0.037

Transformer blocks for 24 V light blocks <sup>(1)</sup>

For use with	Supply voltage V	Description	Reference	Weight kg/lb
Universal LED light blocks	400 V $\sim$ - 50Hz	Transformer 400 V - 24 V $\sim$	ZBV5B <sup>(2)</sup>	0.090/0.198

## Blocks for “test light” function

For use with	Supply voltage V	Description	Reference	Weight kg/lb
Light blocks	12 and 24 $\sim$ 24...120 $\sim$	Single module, 1 connecting wire	ZBZG156 <sup>(3)</sup>	0.010/0.022
Light blocks with Universal LED	48...230 $\sim$	Double module, with connecting wires	ZBZM156 <sup>(4)</sup>	0.010/0.022

<sup>(1)</sup> To be used with 2 dummy contact blocks ZBE000.<sup>(2)</sup> To order 440...460 V  $\sim$  - 60 Hz transformer blocks, replace “5” in the reference with “8”: ZBV5B becomes ZBV8B.  
To order 550...600 V  $\sim$  - 60 Hz transformer blocks, replace “5” with “9”: ZBV5B becomes ZBV9B.<sup>(3)</sup> Block for use with  $\sim$  light blocks with Universal LED types ZBVJ●, ZBVB●, ZBVBG● or with direct supply light block for BA 9s bulb, ZBV6.<sup>(4)</sup> Block for use  $\sim$  light blocks Universal LED types ZBVG●, ZBVM●, see connection on the Schneider Electric website, Harmony XB5 page.

# Control and signaling units

Harmony XB5, plastic

Body/contact assemblies - Spring clamp terminal connections



ZB5AZ009

## Body/fixing collar

For use with	Sold in lots of	Unit reference	Weight kg/lb
Electrical block (contact or light)	10	ZB5AZ009	0.006/0.013

## Contact functions

Spring clamp terminal connections (1)

Contacts for standard applications

Description	Type of contact	Contact configuration		Sold in lots of	Unit reference	Weight kg/lb
		NO	NC			
Contact blocks	Single	1	–	4	ZBE1015	0.011/0.024
		–	1	4	ZBE1025	0.011/0.024
Single with body/fixing collar	Single with body/fixing collar	1	–	1	ZB5AZ1015	0.021/0.046
		–	1	1	ZB5AZ1025	0.021/0.046
		2	–	1	ZB5AZ1035	0.030/0.066
		–	2	1	ZB5AZ1045	0.030/0.066
		1	1	1	ZB5AZ1055	0.030/0.066



ZBE1015



ZB5AZ1015

# Control and signaling units

Harmony XB5, plastic

Light blocks - Spring clamp terminal connections, blank legends



ZBVB35



Light blocks				
Spring clamp terminal connections <sup>(1)</sup>				
Description	Supply voltage V	Sold in lots of	Unit reference	Weight kg/lb
Universal LED	12 ~ (50 or 60 Hz)	4	ZBVJ15	0.016/0.035
	24 ~ (50 or 60 Hz)	4	ZBVB15	0.016/0.035
	110...120 ~ (50 or 60 Hz)	4	ZBVG15	0.016/0.035
	230...240 ~ (50 or 60 Hz)	4	ZBVM15	0.016/0.035

(1) It is not possible to fit an additional block on the back of these contact or light blocks.

# Control and signaling units

## Harmony XB5, plastic

### Body/contact assemblies for printed circuit board



ZB5AZ009

#### Body/fixing collar and accessories specifically for printed circuit board mounting (1) Accessories required when using adaptor (socket) ZBZ010

Description	For use with	Sold in lots of	Unit reference	Weight kg/lb
Body/fixing collar	Electrical block (contact or light)	10	ZB5AZ009	0.006/0.013
Fixing collar/pillar	Printed circuit board support (fixing screw ZBZ006 to be ordered separately)	10	ZB5AZ079	0.003/0.007
Fixing screw for printed circuit board	Fixing collar/pillar ZB5AZ079	10	ZBZ006	0.011/0.024



ZB5AZ079 + ZB5AZ009

#### Adapter (socket) (1)

For use with	Thickness of printed circuit board mm/in.	Sold in lots of	Unit reference	Weight kg/lb
Electrical block (contact or light)	1.6 ± 0.2/0.063 ± 0.008	10	ZBZ010	0.008/0.018
	3.2 ± 0.2/0.126 ± 0.008	10	ZBZ012	0.008/0.018



ZBZ010

#### Contact functions (1)

##### Contacts for standard applications

Description	Type of contact	NO	NC	Sold in lots of	Unit reference	Weight kg/lb
Contact blocks	Single	1	–	10	ZBE701	0.011/0.024
		–	1	10	ZBE702	0.011/0.024



ZBE701



ZBE702

##### Contacts for specific applications

Application	Type of contact	NO	NC	Sold in lots of	Unit reference	Weight kg/lb
Low power switching	Single	1	–	5	ZBE7016	0.012/0.026
		–	1	5	ZBE7026	0.012/0.026

#### Light blocks (1)

Description	Supply voltage V	Color of LED	Sold in lots of	Unit reference	Weight kg/lb
Integral LED (to combine with heads for integral LED)	24 ~ (50 or 60 Hz)	White	5	ZBVB17	0.004/0.009
		Green	5	ZBVB37	0.004/0.009
		Red	5	ZBVB47	0.004/0.009
		Orange	5	ZBVB57	0.004/0.009
		Blue	5	ZBVB67	0.004/0.009



ZBVB37

Protected LED

(1) For details on support drilling and printed circuit board, refer to the Schneider Electric website, Harmony XB5 page.

## Control and signaling units

Harmony XB5, plastic

Body/contact assemblies - Faston connectors



ZBE1023

Contact functions <sup>(1)</sup>

Faston connectors (6.35 or 2 x 2.8 mm/0.250 or 2 x 0.110 in.)

## Contacts for standard applications

Description	Type of contact			Sold in lots of	Unit reference	Weight kg/lb
Contact blocks	Single	1	–	5	ZBE1013	0.011/0.024
		–	1	5	ZBE1023	0.011/0.024
	Double	2	–	5	ZBE2033	0.020/0.044
		1	1	5	ZBE2053	0.020/0.044
	Single with body/fixing collar	1	–	1	ZB5AZ1013 (2)	0.021/0.046
		–	1	1	ZB5AZ1023 (2)	0.021/0.046
		2	–	1	ZB5AZ1033	0.030/0.066
		–	2	1	ZB5AZ1043	0.030/0.066
		1	1	1	ZB5AZ1053	0.030/0.066

## Contacts for specific applications

Application	Type of contact	Description			Sold in lots of	Unit reference	Weight kg/lb
Low power switching	Single	Standard	1	–	5	ZBE10163 (2)	0.012/0.026
		Dusty environments <sup>(3)</sup> (IP 5X, 50 µm dust)	1	–	5	ZBE1016P3 (2)	0.012/0.026
			–	1	5	ZBE1026P3 (2)	0.012/0.026
High power switching	Single	Standard <sup>(4)</sup>	–	1	1	ZBE5023	0.021/0.046
			–	2	1	ZBE5043	0.033/0.073



ZBE5043

Clip-on legend holder for electrical blocks with screw clamp terminal connections <sup>(5)</sup>

For use with	Sold in lots of	Unit reference	Weight kg/lb
Identification of an XB5A control or signaling unit	10	ZBZ001	0.001/0.002

## Sheet of 50 blank legends

Legend holder ZBZ001	10	ZBY001	0.023/0.051
----------------------	----	--------	-------------

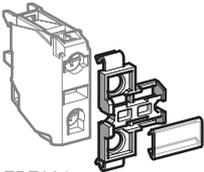

ZBZ001

- (1) The contact blocks enable variable composition of body/contact assemblies. Maximum number of rows possible: 3. Either 3 rows of 3 single contacts or 1 row of 3 double contacts + 1 row of 3 single contacts (double contacts occupy the first 2 rows).
- (2) To order products with screw clamp terminal connections for lugs, replace the 3 at the end of the reference with a 9. Example: ZBE1013 becomes ZBE1019.
- (3) It is not possible to fit an additional contact block on the back of these contact blocks.
- (4) It is not possible to use these contacts with light blocks.
- (5) This legend holder is not compatible with high power switching contacts.

# Control and signaling units

Harmony XB5, plastic

Body/contact assemblies and light blocks with

Universal LED

**Complete body/contact assemblies and light blocks <sup>(1)</sup>**  
**Screw clamp terminal connections (Schneider Electric anti-loosening system)**

Light source	Supply voltage V	Type of contact		Reference	Weight kg/lb	
						
<b>Direct supply</b>						
 Universal LED	24 ~ (50 or 60 Hz)	1	–	ZB5AW0B11	0.032/0.071	
		–	1	ZB5AW0B12	0.032/0.071	
		2	–	ZB5AW0B13	0.042/0.093	
		1	1	ZB5AW0B15	0.042/0.093	
		110...120 ~ (50 or 60 Hz)	1	–	ZB5AW0G11	0.032/0.071
			–	1	ZB5AW0G12	0.032/0.071
	2		–	ZB5AW0G13	0.042/0.093	
	230...240 ~ (50 or 60 Hz)	1	1	ZB5AW0G15	0.042/0.093	
		1	–	ZB5AW0M11	0.032/0.071	
		–	1	ZB5AW0M12	0.032/0.071	
		2	–	ZB5AW0M13	0.042/0.093	
		1	1	ZB5AW0M15	0.042/0.093	

**Other versions** Complete bodies with Faston connector terminals (6.35 or 2 x 2.8/0.250 or 2 x 0.110 in.). Please contact our Customer Care Center.

(1) Can be fitted with additional contact blocks, see [page 101](#).



## Control and signaling units

Harmony XB5, plastic

Body/light assemblies for pilot lights with Universal LED



ZB5AVJ1



Complete light bodies (fixing collar and light block with Universal LED)			
Screw clamp terminal connections (Schneider Electric anti-loosening system)			
Light source	Supply voltage V	Reference	Weight kg/lb
Universal LED light block	12 $\sim$ (50 or 60 Hz)	ZB5AVJ1	0.022/0.049
	24 $\sim$ (1) (50 or 60 Hz)	ZB5AVB1	0.022/0.049
	24...120 $\sim$ (50 or 60 Hz)	ZB5AVBG1	0.022/0.049
	110...120 $\sim$ (1) (50 or 60 Hz)	ZB5AVG1	0.022/0.049
	230...240 $\sim$ (1) (50 or 60 Hz)	ZB5AVM1	0.022/0.049

(1) Complete bodies with Faston connector terminals (6.35 or 2 x 2.8/0.250 or 2 x 0.110 in.), see [page 107](#).

# Control and signaling units

Harmony XB5, plastic

Body/contact assemblies and light blocks with BA 9s base fitting



ZB5AW065



ZB5AW035

Complete body/contact assemblies and light blocks <sup>(1)</sup>						
For bulb with BA 9s base fitting (incandescent, neon or LED)						
Screw clamp terminal connections (Schneider Electric anti-loosening system)						
Light source	Supply voltage V	Type of contact		Color of light source	Reference	Weight kg/lb
		NO	NC			
<b>Direct supply</b>						
BA 9s base fitting bulb, 2.4 W max., not included <sup>(2)</sup>	≤ 250	1	–	–	ZB5AW061	0.031/0.068
		–	1	–	ZB5AW062	0.031/0.068
		2	–	–	ZB5AW063	0.041/0.090
		1	1	–	ZB5AW065	0.041/0.090
<b>Supply via Universal transformer (1.2 VA, 6 V secondary)</b>						
Incandescent BA 9s base fitting bulb, included	110...120 ~ 50 or 60 Hz	1	–	–	ZB5AW031	0.110/0.243
		1	1	–	ZB5AW035	0.119/0.262
	230 ~ 50 Hz	1	–	–	ZB5AW041	0.110/0.243
		1	1	–	ZB5AW045	0.119/0.262
	220...240 ~ 60 Hz	1	–	–	ZB5AW041	0.110/0.243
		1	1	–	ZB5AW045	0.119/0.262
	400 ~ 50 Hz	1	–	–	ZB5AW055	0.119/0.262
		1	1	–	ZB5AW055	0.119/0.262
	230 ~ 50 Hz 220...240 ~ 60 Hz	1	1	White	ZB5AW04D15	0.119/0.262
		1	1	Green	ZB5AW04D35	0.119/0.262
1		1	Red	ZB5AW04D45	0.119/0.262	
1		1	Orange	ZB5AW04D55	0.119/0.262	
1		1	Blue	ZB5AW04D65	0.119/0.262	
<b>Other versions</b>	Complete bodies with Universal transformer incorporating Faston connector terminals (6.35 or 2 x 2.8/0.250 or 2 x 0.110 in.). Please contact our Customer Care Center.					

(1) Can be fitted with additional contact blocks, see page 101.

(2) Bulb to be ordered separately, see page 112.

# Control and signaling units

## Harmony XB5, plastic

### Light bodies for pilot lights with BA 9s base fitting



ZB5AV6



ZB5AV3



ZB5AV156

#### Light blocks

##### Screw clamp terminal connections (Schneider Electric anti-loosening system)

Description	Supply voltage V	Sold in lots of	Unit reference	Weight kg/lb
Direct supply for BA 9s base fitting bulb, 2.4 W max., not included (1)	≤ 250	5	ZBV6	0.016/0.035

##### Complete light bodies (fixing collar and light block)

##### For bulb with BA 9s base fitting (incandescent, neon or LED)

##### Screw clamp terminal connections (Schneider Electric anti-loosening system)

Light source	Supply voltage V	Color of light source	Reference	Weight kg/lb
<b>Direct supply</b>				
BA 9s base fitting bulb, 2.4 W max, not included (1)	≤ 250	–	ZB5AV6	0.022/0.049

##### Supply via Universal transformer (1.2 VA, 6 V secondary)

BA 9s base fitting incandescent bulb, included	110...120 ~ - 50 or 60 Hz	–	ZB5AV3	0.099/0.218
	230 ~ - 50 Hz	–	ZB5AV4	0.099/0.218
	220...240 ~ - 60 Hz	–	ZB5AV4	0.099/0.218
	400 ~ - 50 Hz	–	ZB5AV5	0.099/0.218
	440...480 ~ - 60 Hz	–	ZB5AV8	0.099/0.218
BA 9s base fitting LED, included	550...600 ~ - 60 Hz	–	ZB5AV9	0.099/0.218
	400 ~ - 50 or 60 Hz	White	ZB5AV5D1	0.102/0.225
		Green	ZB5AV5D3	0.102/0.225
		Red	ZB5AV5D4	0.102/0.225
		Orange	ZB5AV5D5	0.102/0.225
		Blue	ZB5AV5D6	0.102/0.225

##### Complete light bodies with 3-terminal "test" function (fixing collar + light block)

##### For bulb with BA 9s base fitting (incandescent, neon or LED)

##### Screw clamp terminal connections (Schneider Electric anti-loosening system)

Light source	Supply voltage V	Reference	Weight kg/lb
<b>Direct supply</b>			
BA 9s base fitting bulb, 2.4 W max, not included (1)	≤ 250	ZB5AV156	0.021/0.046

**Other versions** Complete bodies with Faston connector terminals (6.35 or 2 x 2.8/0.250 or 2 x 0.110 in.), see [page 82](#).

(1) Bulb to be ordered separately, see [page 112](#).



DL1CJ0●●●



DL1CE●●●



DL1CF●●●



XBFX13



ZB5AZ31



ZB5AZ905



ZB5AZ902



ZB5FAZ902

## Bulbs with BA 9s base fitting and associated accessories

## Illuminated pushbuttons

Description	Characteristics	Color	Sold in lots of	Unit reference	Weight kg/lb	
LEDs	24 V ~	White	1	<a href="#">DL1CJ0241</a>	0.002/0.004	
		Green	1	<a href="#">DL1CJ0243</a>	0.002/0.004	
		Red	1	<a href="#">DL1CJ0244</a>	0.002/0.004	
		Orange	1	<a href="#">DL1CJ0245</a>	0.002/0.004	
		Blue	1	<a href="#">DL1CJ0246</a>	0.002/0.004	
		48 V ~	Green	1	<a href="#">DL1CJ0483</a>	0.002/0.004
	Red		1	<a href="#">DL1CJ0484</a>	0.002/0.004	
	Orange		1	<a href="#">DL1CJ0485</a>	0.002/0.004	
	6 V - 1.2 W		White	1	<a href="#">DL1CD0061</a>	0.002/0.004
			Green	1	<a href="#">DL1CD0063</a>	0.002/0.004
			Red	1	<a href="#">DL1CD0064</a>	0.002/0.004
		Orange	1	<a href="#">DL1CD0065</a>	0.002/0.004	
Incandescent bulbs	6 V - 1.2 W	–	10	<a href="#">DL1CB006</a>	0.002/0.004	
	24 V - 2 W	–	10	<a href="#">DL1CE024</a>	0.002/0.004	
	120...130 V 2.4 W	–	10	<a href="#">DL1CE130</a>	0.002/0.004	
Neon bulbs	120...130 V	–	10	<a href="#">DL1CF110</a>	0.002/0.004	
	230...240 V	–	10	<a href="#">DL1CF220</a>	0.002/0.004	
Bulb extractor	–	–	1	<a href="#">XBFX13</a>	0.005/0.011	
Description	Application	Color	Sold in lots of	Unit reference	Weight kg/lb	
Add-on square trim	Gives a square appearance to ZB5A circular heads	Black	10	<a href="#">ZB5AZ31</a>	0.002/0.004	
		Green	10	<a href="#">ZB5AZ1715626002</a>	0.002/0.004	
		Red	10	<a href="#">ZB5AZ1715626001</a>	0.002/0.004	
		Blue	10	<a href="#">ZB5AZ1715626003</a>	0.002/0.004	
Nut	For fixing ZB5A heads	Green	10	<a href="#">ZB5AZ903</a>	0.002/0.004	
Fixing nut for flush mounted heads	For fixing ZB5FA heads	Green	10	<a href="#">ZB5FAZ901</a>	0.102/0.225	
Bezel tool	For tightening ZB5AZ901 head fixing nut		1	<a href="#">ZB5AZ905</a>	0.016/0.035	
Anti-rotation plate	For ZB5A selector switches and Emergency stop pushbutton heads		10	<a href="#">ZB5AZ902</a>	0.008/0.018	
Anti-rotation plate for flush mounted heads	For ZB5F selector switch heads		10	<a href="#">ZB5FAZ902</a>	0.008/0.018	

## Control and signaling units

Harmony XB5, plastic

Accessories for pushbuttons: keys



ZBG455



ZBG455P



ZBGP



ZBDD2

## Replacement keys

Description	Key number	Reference	Weight kg/lb
<b>For latching mushroom head pushbuttons and selector switches</b>			
Sets of 2 keys	455	<a href="#">ZBG455</a>	0.013/0.029
	421E	<a href="#">ZBG421E</a>	0.014/0.031
	458A	<a href="#">ZBG458A</a>	0.014/0.031
	520E	<a href="#">ZBG520E</a>	0.014/0.031
	3131A	<a href="#">ZBG3131A</a>	0.014/0.031
	4A185	<a href="#">ZBDA185</a>	0.014/0.031
	8D1	<a href="#">ZBD8D1</a>	0.014/0.031
	Specific key	<a href="#">ZBGK (1)</a>	0.014/0.031

## For booted selector switches

Sets of 2 keys, one of which is supplied booted (rubber boot)	455	<a href="#">ZBG455P</a>	–
--	-----	-------------------------	---

## Accessory for key switches (2)

Description	Function	Reference	Weight kg/lb
Keyhole cover (rubber boot)	Protection of lock barrel when no key inserted in lock	<a href="#">ZBGP</a>	0.005/0.011

## Boot for standard handle

Description	For use with	Sold in lots of	Unit reference	Weight kg/lb
Boot for standard handle	ZB4BD●● and ZB5AD●●	10	<a href="#">ZBDD2</a>	0.005/0.011

(1) Key number to be added when ordering.

(2) Not compatible with products with key TEC10.

## Control and signaling units

Harmony XB5, plastic

Legends panel

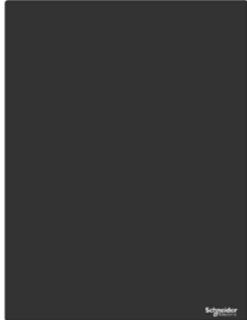

ZBYLEG304000

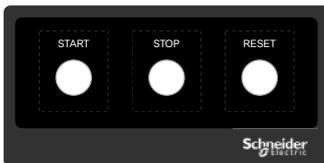

ZBYLEG201001



ZBYLEG304001



ZBYLEG503001

## Legends panel (1)

Template size mm/in.	Unit reference	Weight kg/lb
<b>Unmarked templates</b>		
100 x 100/3.93 x 3.93	ZBYLEG101000	0.010/0.022
200 x 100/7.87 x 3.93	ZBYLEG201000	0.010/0.022
300 x 100/11.81 x 3.93	ZBYLEG301000	0.010/0.022
300 x 200/11.81 x 7.87	ZBYLEG302000	0.030/0.066
300 x 300/11.81 x 11.81	ZBYLEG303000	0.030/0.066
300 x 400/11.81 x 15.74	ZBYLEG304000	0.030/0.066
400 x 100/15.74 x 3.93	ZBYLEG401000	0.010/0.022
400 x 200/15.74 x 7.87	ZBYLEG402000	0.050/0.110
500 x 100/19.68 x 3.93	ZBYLEG501000	0.030/0.066
500 x 200/19.68 x 7.87	ZBYLEG502000	0.050/0.110
500 x 300/19.68 x 11.81	ZBYLEG503000	0.050/0.110
500 x 400/19.68 x 15.74	ZBYLEG504000	0.050/0.110
<b>Marked templates</b>		
100 x 100/3.93 x 3.93	ZBYLEG101001	0.010/0.022
200 x 100/7.87 x 3.93	ZBYLEG201001	0.010/0.022
300 x 100/11.81 x 3.93	ZBYLEG301001	0.010/0.022
300 x 200/11.81 x 7.87	ZBYLEG302001	0.030/0.066
300 x 300/11.81 x 11.81	ZBYLEG303001	0.030/0.066
300 x 400/11.81 x 15.74	ZBYLEG304001	0.030/0.066
400 x 100/15.74 x 3.93	ZBYLEG401001	0.010/0.022
400 x 200/15.74 x 7.87	ZBYLEG402001	0.050/0.110
500 x 100/19.68 x 3.93	ZBYLEG501001	0.030/0.066
500 x 200/19.68 x 7.87	ZBYLEG502001	0.050/0.110
500 x 300/19.68 x 11.81	ZBYLEG503001	0.050/0.110
500 x 400/19.68 x 15.74	ZBYLEG504001	0.050/0.110

(1) To add customized markings on these references using the web customization tool, see [page 5](#)

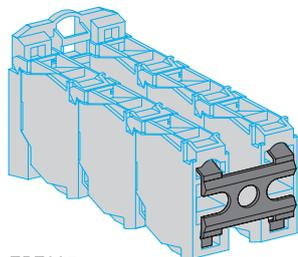

ZBZ007

## Other accessories

Description	For use with	Color	Sold in lots of	Unit reference		Weight kg/lb
				For black bezel	For gray bezel	
<b>Plastic clips</b>	2 or 3 levels of ZBE10● contact blocks in high vibration environment	–	10	ZBZ007	–	0.001/0.002
<b>Dummy contact block</b>	ZBE10● contact blocks and ZBV5B transformer blocks	–	5	ZBE000	–	0.006/0.013
<b>Set of tabs for Faston connection</b>	ZBE10● contact blocks and ZBV● light blocks	–	10	ZBZ003	–	–

<b>D</b>					
DL1CD0061	112	XB5AD912R4K7	64	XB5AP31	31
DL1CD0063	112	XB5AD912R10K	64	XB5AP31C0	31
DL1CD0064	112	XB5AD912R47K	64	XB5AP42	31
DL1CD0065	112	XB5AD912R100K	64	XB5AP51	31
DL1CD0066	112	XB5AD912R470K	64	XB5AP51C0	31
DL1CE024	112	XB5AG03	56	XB5AP61	31
DL1CE130	112	XB5AG03C0	56	XB5AP61C0	31
DL1CF110	112	XB5AG21	56	XB5AS84W3B5	43
DL1CF220	112	XB5AG21C0	56	XB5AS84W3B41	43
DL1CJ0241	112	XB5AG33	56	XB5AS8442	41
DL1CJ0243	112	XB5AG33C0	56	XB5AS8444	41
DL1CJ0244	112	XB5AG41	56	XB5AS8445	41
DL1CJ0245	112	XB5AG41C0	56	XB5AS8446	41
DL1CJ0246	112	XB5AG61	56	XB5AS9442	41
DL1CJ0483	112	XB5AG61C0	56	XB5AS9445	41
DL1CJ0484	112	XB5AJ21	55	XB5AS84449	45
DL1CJ0485	112	XB5AJ21C0	55	XB5AS84462	41
		XB5AJ33	55	XB5AS86449B4	45
		XB5AJ33C0	55	XB5AT842	41
		XB5AJ53	55	XB5AT845	41
XB5AA11	29	XB5AJ53C0	55	XB5AV5B1	62
XB5AA11C0	29	XB5AK123B5	58	XB5AV5B3	62
XB5AA21	29	XB5AK123B5C0	58	XB5AV5B4	62
XB5AA21C0	29	XB5AK123G5	58	XB5AV5B5	62
XB5AA31	29	XB5AK123G5C0	58	XB5AV5B6	62
XB5AA31C0	29	XB5AK123M5	58	XB5AV31	62
XB5AA42	29	XB5AK123M5C0	58	XB5AV33	62
XB5AA42C0	29	XB5AK124B5	58	XB5AV34	62
XB5AA51	29	XB5AK124B5C0	58	XB5AV35	62
XB5AA51C0	29	XB5AK124G5	58	XB5AV41	62
XB5AA61	29	XB5AK124G5C0	58	XB5AV43	62
XB5AA61C0	29	XB5AK124M5	58	XB5AV44	62
XB5AA801	64	XB5AK124M5C0	58	XB5AV45	62
XB5AA831	64	XB5AK125B5	58	XB5AV61	62
XB5AA841	64	XB5AK125B5C0	58	XB5AV63	62
XB5AA861	64	XB5AK125G5	58	XB5AV64	62
XB5AA3311	32	XB5AK125G5C0	58	XB5AV65	62
XB5AA3311C0	32	XB5AK125M5	58	XB5AVB1	60
ZB5AA331C0	32	XB5AK125M5C0	58	XB5AVB3	60
XB5AA3341	32	XB5AK133B5	58	XB5AVB4	60
XB5AA3341C0	32	XB5AK133B5C0	58	XB5AVB5	60
XB5AA3351	32	XB5AK133G5	58	XB5AVB6	60
XB5AA3351C0	32	XB5AK133G5C0	58	XB5AVG1	60
XB5AA4322	32	XB5AK133M5	58	XB5AVG3	60
XB5AA4322C0	32	XB5AK133M5C0	58	XB5AVG4	60
ZB5AZ102	32	XB5AK134B5	58	XB5AVG5	60
ZB5AA432C0	32	XB5AK134B5C0	58	XB5AVG6	60
XB5AA84101	64	XB5AK134G5	58	XB5AVM1	60
XB5AA86102	64	XB5AK134G5C0	58	XB5AVM3	60
XB5AA711237	38	XB5AK134M5	58	XB5AVM4	60
XB5AA731327	38	XB5AK134M5C0	58	XB5AVM5	60
XB5AC21	39	XB5AK135B5	58	XB5AVM6	60
XB5AD21	54	XB5AK135B5C0	58	XB5AW21B5	63
XB5AD21C0	54	XB5AK135G5	58	XB5AW21G5	63
XB5AD25	54	XB5AK135G5C0	58	XB5AW23B5	63
XB5AD25C0	54	XB5AK135M5	58	XB5AW23G5	63
XB5AD33	54	XB5AK135M5C0	58	XB5AW24B5	63
XB5AD33C0	54	XB5AL42	30	XB5AW24G5	63
XB5AD41	54	XB5AL42C0	30	XB5AW25B5	63
XB5AD41C0	54	XB5AL73415	37	XB5AW25G5	63
XB5AD53	54	XB5AL84101	64	XB5AW26B5	63
XB5AD53C0	54	XB5AP21	31	XB5AW26G5	63
XB5AD912R1K	64	XB5AP21C0	31	XB5AW28B5	63
				XB5AW28G5	63
				XB5AW31B5	33
				XB5AW31B5C0	33
				XB5AW31G5	33
				XB5AW31G5C0	33
				XB5AW31M5	33
				XB5AW31M5C0	33
				XB5AW33B5	33
				XB5AW33B5C0	33
				XB5AW33G5	33
				XB5AW33G5C0	33
				XB5AW33M5	33
				XB5AW33M5C0	33
				XB5AW34B5	33
				XB5AW34B5C0	33
				XB5AW34G5	33
				XB5AW34G5C0	33
				XB5AW34M5	33
				XB5AW34M5C0	33
				XB5AW35B5	33
				XB5AW35B5C0	33
				XB5AW35G5	33
				XB5AW35G5C0	33
				XB5AW35M5	33
				XB5AW35M5C0	33
				XB5AW36B5	33
				XB5AW36B5C0	33
				XB5AW36G5	33
				XB5AW36G5C0	33
				XB5AW36M5	33
				XB5AW36M5C0	33
				XB5AW3165	36
				XB5AW3365	36
				XB5AW3465	36
				XB5AW3565	36
				XB5AW73731B5	37
				XB5AW73731G5	37
				XB5AW73731M5	37
				XB5DSB	65
				XB5DSG	65
				XB5DSM	65
				XB5DT1S	66
				XB5DTB22	65
				XB5DTB23	65
				XB5DTB24	65
				XB5DTB25	65
				XB5DTGM2	65
				XB5DTGM3	65
				XB5DTGM4	65
				XB5DTGM5	65
				XB5EV57K4	63
				XB5EV57L4	63
				XB5EVB1	60
				XB5EVB3	60
				XB5EVB4	60
				XB5EVB5	60
				XB5EVB6	60
				XB5EVB8	60
				XB5EVG1	60
				XB5EVG3	60
				XB5EVG4	60
				XB5EVG5	60
				XB5EVG6	60
				XB5EVG8	60
				XB5EVM1	60
				XB5EVM3	60
				XB5EVM4	60
				XB5EVM5	60
				XB5EVM6	60
				XB5EVM8	60
				XB5FA11	79
				XB5FA11C0	79
				XB5FA21	79
				XB5FA21C0	79
				XB5FA31	79
				XB5FA31C0	79
				XB5FA42	79
				XB5FA42C0	79
				XB5FA51	79
				XB5FA51C0	79
				XB5FA61	79
				XB5FA61C0	79
				XB5FA3311	81
				XB5FA3311C0	81
				XB5FA3341	81
				XB5FA3341C0	81
				XB5FA3351	81
				XB5FA3351C0	81
				XB5FA4322	81
				XB5FA4322C0	81
				XB5FD21	87
				XB5FD21C0	87
				XB5FD25	87
				XB5FD25C0	87
				XB5FD33	87
				XB5FD33C0	87
				XB5FD41	87
				XB5FD41C0	87
				XB5FD53	87
				XB5FD53C0	87
				XB5FG03	89
				XB5FG03C0	89
				XB5FG21	89
				XB5FG21C0	89
				XB5FG33	89
				XB5FG33C0	89
				XB5FG41	89
				XB5FG41C0	89
				XB5FG61	89
				XB5FG61C0	89
				XB5FJ21	88
				XB5FJ21C0	88
				XB5FJ33	88
				XB5FJ33C0	88
				XB5FJ53	88
				XB5FJ53C0	88
				XB5FK123B5	91
				XB5FK123B5C0	91
				XB5FK123G5	91
				XB5FK123G5C0	91
				XB5FK123M5	91
				XB5FK123M5C0	91
				XB5FK124B5	91
				XB5FK124B5C0	91
				XB5FK124G5	91
				XB5FK124M5	91

XB5FK124M5C0	91	XB5FW34B5C0	82	ZB5AA8	29	ZB5AA7213	37	ZB5AG2	56
XB5FK125B5	91	XB5FW34G5	82	ZB5AA8C0	29	ZB5AA7340	37	ZB5AG02	56
XB5FK125B5C0	91	XB5FW34G5C0	82	ZB5AA9	29	ZB5AA7341	37	ZB5AG2C0	56
XB5FK125G5	91	XB5FW34M5	82	ZB5AA16	30	ZB5AA71123	38	ZB5AG2D	57
XB5FK125M5	91	XB5FW34M5C0	82	ZB5AA16C0	30	ZB5AA71124	38	ZB5AG02D	57
XB5FK125M5C0	91	XB5FW35B5	82	ZB5AA18	29	ZB5AA72124	38	ZB5AG2DC0	57
XB5FK133B5	91	XB5FW35B5C0	82		34	ZB5AA73134	38	ZB5AG3	56
XB5FK133B5C0	91	XB5FW35G5	82	ZB5AA18C0	29	ZB5AC2	39	ZB5AG3C0	56
XB5FK133G5	91	XB5FW35G5C0	82		34	ZB5AC3	39	ZB5AG3D	57
XB5FK133M5	91	XB5FW35M5	82	ZB5AA26	30	ZB5AC4	39	ZB5AG03D	57
XB5FK133M5C0	91	XB5FW35M5C0	82	ZB5AA26C0	30	ZB5AC5	39	ZB5AG4	56
XB5FK134B5	91	XB5FW36B5	82	ZB5AA36	30	ZB5AC6	39	ZB5AG4C0	56
XB5FK134G5	91	XB5FW36B5C0	82	ZB5AA36C0	30	ZB5AC24	39	ZB5AG4D	57
XB5FK134M5	91	XB5FW36G5	82	ZB5AA38	29	ZB5AC34	39	ZB5AG4DC0	57
XB5FK135B5	91	XB5FW36G5C0	82	ZB5AA38C0	29	ZB5AC44	39	ZB5AG5	56
XB5FK135G5	91	XB5FW36M5	82		34	ZB5AC54	39	ZB5AG05	56
XB5FK135M5	91	XB5FW36M5C0	82	ZB5AA46	30	ZB5AC64	39	ZB5AG05C0	56
XB5FL42	80	XB5KS2B4	65	ZB5AA46C0	30	ZB5AC180	51	ZB5AG6	56
XB5FL42C0	80	XB5KS2B8	65	ZB5AA48	29	ZB5AC280	51	ZB5AG6C0	56
XB5FL4322	81	XB5KS2G4	65		34	ZB5AC380	51	ZB5AG6D	57
XB5FVB1	92	XB5KS2G8	65	ZB5AA48C0	29	ZB5AC480	51	ZB5AG7	56
XB5FVB1C0	92	XB5KS2M4	65		34	ZB5AC580	51	ZB5AG7C0	56
XB5FVB3	92	XB5KS2M8	65	ZB5AA56	30	ZB5AC680	51	ZB5AG07D	57
XB5FVB3C0	92	XB5KSB	65	ZB5AA58	29	ZB5AC28001	51	ZB5AG7D	57
XB5FVB4	92	XB5KSG	65		34	ZB5AC38023	51	ZB5AG8	56
XB5FVB4C0	92	XB5KSM	65	ZB5AA58C0	29	ZB5AC48021	51	ZB5AG08	56
XB5FVB5	92	XB5PRJ45	66		34	ZB5AD2	54	ZB5AG08C0	56
XB5FVB5C0	92	XB5PUSB3	66	ZB5AA66	30	ZB5AD2C0	54	ZB5AG9	56
XB5FVB6	92	XBFX13	112	ZB5AA66C0	30	ZB5AD3	54	ZB5AG09	56
XB5FVB6C0	92	XBH1AA0G4	66	ZB5AA68	29	ZB5AD3C0	54	ZB5AG9C0	56
XB5FVG1	92	XBH1AA0R4	66		34	ZB5AD4	54	ZB5AH01	52
XB5FVG1C0	92	XD5PA12	67	ZB5AA68C0	29	ZB5AD4C0	54	ZB5AH1	52
XB5FVG3	92	XD5PA14	67		34	ZB5AD5	54	ZB5AH01C0	52
XB5FVG3C0	92	XD5PA22	67	ZB5AA79	37	ZB5AD5C0	54	ZB5AH1C0	52
XB5FVG4	92	XD5PA24	67	ZB5AA88	34	ZB5AD7	54	ZB5AH02	52
XB5FVG4C0	92			ZB5AA88C0	34	ZB5AD7C0	54	ZB5AH2	52
XB5FVG5	92			ZB5AA98	29	ZB5AD8	54	ZB5AH02C0	52
XB5FVG5C0	92	<b>Z</b>			34	ZB5AD8C0	54	ZB5AH2C0	52
XB5FVG6	92	ZB2BE101	101	ZB5AA131	32	ZB5AD28	57	ZB5AH03	52
XB5FVG6C0	92	ZB2BE102	101	ZB5AA131C0	32	ZB5AD28C0	57	ZB5AH3	52
XB5FVM1	92	ZB4BZ007	77	ZB5AA145	32	ZB5AD28C0	57	ZB5AH03C0	52
XB5FVM1C0	92	ZB4BZ62	49	ZB5AA232	32	ZB5AD29	57	ZB5AH3C0	52
XB5FVM3	92	ZB4BZ64	49	ZB5AA234	32	ZB5AD29C0	57	ZB5AH04	52
XB5FVM3C0	92	ZB4BZ65	49	ZB5AA245	32	ZB5AD39	57	ZB5AH4	52
XB5FVM4	92	ZB4BZ66	49	ZB5AA331	32	ZB5AD39C0	57	ZB5AH4	52
XB5FVM4C0	92	ZB4BZ0077	77	ZB5AA333	32	ZB5AD48C0	57	ZB5AH04C0	52
XB5FVM5	92	ZB4BZ1905	49	ZB5AA333C0	32	ZB5AD49C0	57	ZB5AH4C0	52
XB5FVM5C0	92	ZB4BZ2005	49	ZB5AA334	32	ZB5AD59	57	ZB5AH05	52
XB5FVM6	92	ZB4BZ2105	49	ZB5AA334C0	32	ZB5AD59C0	57	ZB5AH5	52
XB5FVM6C0	92	ZB4FBZ007	95	ZB5AA335	32	ZB5AD79C0	57	ZB5AH05C0	52
XB5FW31B5	82	ZB4FBZ014	95	ZB5AA335C0	32	ZB5AD89C0	57	ZB5AH5C0	52
XB5FW31B5C0	82	ZB5AA0	29	ZB5AA336	32	ZB5AD912	64	ZB5AH06	52
XB5FW31G5	82	ZB5AA1	29	ZB5AA341	32	ZB5AD922	64	ZB5AH6	52
XB5FW31G5C0	82	ZB5AA1C0	29	ZB5AA342	32	ZB5AD2801	57	ZB5AH06C0	52
XB5FW31M5	82	ZB5AA2	29	ZB5AA343	32	ZB5AD2801C0	57	ZB5AH6C0	52
XB5FW31M5C0	82	ZB5AA2C0	29	ZB5AA344	32	ZB5AD2804	57	ZB5AH013	52
XB5FW33B5	82	ZB5AA3	29	ZB5AA432	32	ZB5AD2804C0	57	ZB5AH13	52
XB5FW33B5C0	82	ZB5AA3C0	29	ZB5AA433	32	ZB5AD2806C0	57	ZB5AH013C0	52
XB5FW33G5	82	ZB5AA4	29	ZB5AA434	32	ZB5AF	53	ZB5AH13C0	52
XB5FW33G5C0	82	ZB5AA4C0	29	ZB5AA434C0	32	ZB5AF351	53	ZB5AH033	52
XB5FW33M5	82	ZB5AA5	29	ZB5AA435	32	ZB5AG0	56	ZB5AH33	52
XB5FW33M5C0	82	ZB5AA5C0	29	ZB5AA791	38	ZB5AG0C0	56	ZB5AH033C0	52
XB5FW33M5C0	82	ZB5AA6	29	ZB5AA7120	37	ZB5AG0D	57	ZB5AH33C0	52
XB5FW34B5	82	ZB5AA6C0	29	ZB5AA7121	37	ZB5AG1	56	ZB5AH043	52

ZB5AH43	52	ZB5AK1513	59	ZB5AP4S	31	ZB5AV5D1	111	ZB5AW11	36
ZB5AH043C0	52	ZB5AK1513C0	59		70	ZB5AV5D3	111	ZB5AW13	36
ZB5AH43C0	52	ZB5AK1533	59	ZB5AP5	31	ZB5AV5D4	111	ZB5AW14	36
ZB5AH053	52	ZB5AK1533C0	59	ZB5AP5S	31	ZB5AV5D5	111	ZB5AW15	36
ZB5AH53	52				70	ZB5AV5D6	111	ZB5AW16	36
ZB5AH053C0	52	ZB5AK1543	59	ZB5AP6	31	ZB5AV05S	62	ZB5AW17	36
ZB5AH53C0	52	ZB5AK1543C0	59	ZB5AP6S	31	ZB5AV06	62	ZB5AW31	36
ZB5AH063	52	ZB5AK1553	59		70	ZB5AV6	111	ZB5AW031	110
ZB5AH63	52	ZB5AK1553C0	59	ZB5AP18	31	ZB5AV06S	62	ZB5AW33	36
ZB5AH063C0	52	ZB5AK1563	59	ZB5AP38	31	ZB5AV07	62	ZB5AW34	36
ZB5AH63C0	52	ZB5AK1563C0	59	ZB5AP48	31	ZB5AV07S	62	ZB5AW35	36
ZB5AH083	52	ZB5AK1583	59	ZB5AP58	31	ZB5AV8	111	ZB5AW035	110
ZB5AH83	52	ZB5AK1583C0	59	ZB5AP68	31	ZB5AV9	111	ZB5AW36	36
ZB5AH083C0	52	ZB5AK1713	59	ZB5AP183	31	ZB5AV013	61	ZB5AW37	36
ZB5AH83C0	52	ZB5AK1713C0	59	ZB5AP383	31	ZB5AV013E	61	ZB5AW041	110
ZB5AJ2	55	ZB5AK1733	59	ZB5AP483	31	ZB5AV013S	61	ZB5AW045	110
ZB5AJ2C0	55	ZB5AK1733C0	59	ZB5AP583	31	ZB5AV033	61	ZB5AW055	110
ZB5AJ3	55	ZB5AK1743	59	ZB5AP683	31	ZB5AV033E	61	ZB5AW061	110
ZB5AJ3C0	55	ZB5AK1743C0	59	ZB5AR2	39	ZB5AV033S	61	ZB5AW062	110
ZB5AJ4	55	ZB5AK1753	59	ZB5AR3	39	ZB5AV043	61	ZB5AW063	110
ZB5AJ4C0	55	ZB5AK1753C0	59	ZB5AR4	39	ZB5AV043E	61	ZB5AW065	110
ZB5AJ5	55	ZB5AK1763	59	ZB5AR5	39	ZB5AV043S	61	ZB5AW113	35
ZB5AJ5C0	55	ZB5AK1763C0	59	ZB5AR6	39	ZB5AV053	61	ZB5AW113C0	35
ZB5AJ7	55	ZB5AK1783	59	ZB5AS12	40	ZB5AV053E	61	ZB5AW133	35
ZB5AJ7C0	55	ZB5AK1783C0	59	ZB5AS42	40	ZB5AV053S	61	ZB5AW133C0	35
ZB5AJ8	55	ZB5AK1813	59	ZB5AS52	40	ZB5AV063	61	ZB5AW143	35
ZB5AJ8C0	55	ZB5AK1813C0	59	ZB5AS55	40	ZB5AV063E	61	ZB5AW143C0	35
ZB5AK1213	59	ZB5AK1833	59	ZB5AS62	40	ZB5AV063S	61	ZB5AW153	35
ZB5AK1213C0	59	ZB5AK1833C0	59	ZB5AS72	40	ZB5AV083	61	ZB5AW153C0	35
ZB5AK1233	59	ZB5AK1843	59	ZB5AS84W00	43	ZB5AV083E	61	ZB5AW163	35
ZB5AK1233C0	59	ZB5AK1843C0	59	ZB5AS84W2B	43	ZB5AV083S	61	ZB5AW163C0	35
ZB5AK1243	59	ZB5AK1853	59	ZB5AS84W2G	43	ZB5AV156	111	ZB5AW183	35
ZB5AK1243C0	59	ZB5AK1853C0	59	ZB5AS84W2M	43	ZB5AVB1	109	ZB5AW183C0	35
ZB5AK1253	59	ZB5AK1863	59	ZB5AS84W3B	43	ZB5AVBG1	109	ZB5AW313	34
ZB5AK1253C0	59	ZB5AK1863C0	59	ZB5AS834	41	ZB5AVG1	109	ZB5AW313C0	34
ZB5AK1263	59	ZB5AK1883	59	ZB5AS842Y	50	ZB5AVJ1	109	ZB5AW313S	34
ZB5AK1263C0	59	ZB5AK1883C0	59	ZB5AS844	41	ZB5AVM1	109	ZB5AW313SC0	34
ZB5AK1283	59	ZB5AL1	30	ZB5AS934	41	ZB5AW0B11	108	ZB5AW333	34
ZB5AK1283C0	59	ZB5AL1C0	30	ZB5AS944	41	ZB5AW0B12	108	ZB5AW333C0	34
ZB5AK1313	59	ZB5AL2	30	ZB5AS944D	41	ZB5AW0B13	108	ZB5AW333S	34
ZB5AK1313C0	59	ZB5AL2C0	30	ZB5AS964	41	ZB5AW0B15	108	ZB5AW333SC0	34
ZB5AK1333	59	ZB5AL3	30	ZB5AT2	40	ZB5AW0G11	108	ZB5AW343	34
ZB5AK1333C0	59	ZB5AL3C0	30	ZB5AT24	40	ZB5AW0G12	108	ZB5AW343C0	34
ZB5AK1343	59	ZB5AL4	30	ZB5AT84	41	ZB5AW0G13	108	ZB5AW343S	34
ZB5AK1343C0	59	ZB5AL4C0	30	ZB5AT844	41	ZB5AW0G15	108	ZB5AW343SC0	34
ZB5AK1353	59	ZB5AL5	30	ZB5AT8643M	44	ZB5AW0M11	108	ZB5AW353	34
ZB5AK1353C0	59	ZB5AL5C0	30	ZB5AT8643M130	44	ZB5AW0M12	108	ZB5AW353C0	34
ZB5AK1363	59	ZB5AL6	30	ZB5AT8643M140	44	ZB5AW0M13	108	ZB5AW353S	34
ZB5AK1363C0	59	ZB5AL6C0	30	ZB5AT8643M230	44	ZB5AW0M15	108	ZB5AW353SC0	34
ZB5AK1383	59	ZB5AL232	32	ZB5AT8643M330	44	ZB5AW04D15	110	ZB5AW363	34
ZB5AK1383C0	59	ZB5AL432	32	ZB5AT8643M430	44	ZB5AW04D35	110	ZB5AW363C0	34
ZB5AK1413	59	ZB5AL432C0	32	ZB5AT8643M630	44	ZB5AW04D45	110	ZB5AW363S	34
ZB5AK1413C0	59	ZB5AL434	32	ZB5AV01	62	ZB5AW04D55	110	ZB5AW363SC0	34
ZB5AK1433	59	ZB5AL7340	37	ZB5AV01S	62	ZB5AW04D65	110	ZB5AW383	34
ZB5AK1433C0	59	ZB5AL7341	37	ZB5AV003	61	ZB5AW7A9	37	ZB5AW383C0	34
ZB5AK1443	59	ZB5AP1	31	ZB5AV03	62	ZB5AW7A1715	37	ZB5AW383S	34
ZB5AK1443C0	59	ZB5AP1S	31	ZB5AV3	111	ZB5AW7A1720	37	ZB5AW383SC0	34
ZB5AK1453	59		70	ZB5AV01	62	ZB5AW7A1721	37	ZB5AW513	34
ZB5AK1453C0	59	ZB5AP2	31	ZB5AV03S	62	ZB5AW7A1724	37	ZB5AW513C0	34
ZB5AK1463	59	ZB5AP2S	31	ZB5AV04	62	ZB5AW7A3740	37	ZB5AW533	34
ZB5AK1463C0	59		70	ZB5AV4	111	ZB5AW7A3741	37	ZB5AW533C0	34
ZB5AK1483	59	ZB5AP3	31	ZB5AV04S	62	ZB5AW7L3740	37	ZB5AW543	34
ZB5AK1483C0	59	ZB5AP3S	31	ZB5AV05	62	ZB5AW7L3741	37	ZB5AW543C0	34
		ZB5AP4	31	ZB5AV5	111				

ZB5AW553	34	ZB5FA3C0	79	ZB5FA344	81	ZB5FG07D	90	ZB5FJ3C0	88
ZB5AW553C0	34	ZB5FA3M33	79	ZB5FA432	81	ZB5FG8	89	ZB5FJ4	88
ZB5AW563	34	ZB5FA4	79	ZB5FA432C0	81	ZB5FG08	89	ZB5FJ4C0	88
ZB5AW563C0	34	ZB5FA4C0	79	ZB5FA433	81	ZB5FG08C0	89	ZB5FJ5	88
ZB5AW583	34	ZB5FA5	79	ZB5FA434	81	ZB5FG8D	90	ZB5FJ5C0	88
ZB5AW583C0	34	ZB5FA5C0	79	ZB5FA434C0	81	ZB5FG08D	90	ZB5FJ7	88
ZB5AW713	40	ZB5FA6	79	ZB5FA435	81	ZB5FG9	89	ZB5FJ7C0	88
ZB5AW733	40	ZB5FA6C0	79	ZB5FAZ901	112	ZB5FG09	89	ZB5FJ8	88
ZB5AW743	44	ZB5FA8	79	ZB5FAZ902	112	ZB5FG9D	90	ZB5FJ8C0	88
ZB5AW753	40	ZB5FA8C0	79	ZB5FD2	87	ZB5FG09D	90	ZB5FL1	80
ZB5AW763	40	ZB5FA9	79	ZB5FD2C0	87	ZB5FH0	85	ZB5FL2	80
ZB5AW913	34	ZB5FA9C0	79	ZB5FD2M178	87	ZB5FH0C0	85	ZB5FL2C0	80
ZB5AW933	34	ZB5FA16	79	ZB5FD3	87	ZB5FH01	85	ZB5FL3	80
ZB5AW943	34	ZB5FA16C0	79	ZB5FD3C0	87	ZB5FH1	85	ZB5FL3C0	80
ZB5AW953	34	ZB5FA18	79	ZB5FD4	87	ZB5FH01C0	85	ZB5FL4	80
ZB5AW963	34		83	ZB5FD4C0	87	ZB5FH1C0	85	ZB5FL4C0	80
ZB5AW983	34	ZB5FA18C0	79	ZB5FD5	87	ZB5FH02	85	ZB5FL4M34	80
ZB5AX2	40		83	ZB5FD5C0	87	ZB5FH2	85	ZB5FL5	80
ZB5AX84	41	ZB5FA26	79	ZB5FD7	87	ZB5FH02C0	85	ZB5FL5C0	80
ZB5AZ009	101	ZB5FA26C0	79	ZB5FD7C0	87	ZB5FH2C0	85	ZB5FL6	80
	106	ZB5FA36	79	ZB5FD8	87	ZB5FH03	85	ZB5FL6C0	80
ZB5AZ009	104	ZB5FA36C0	79	ZB5FD8C0	87	ZB5FH3	85	ZB5FL232	81
ZB5AZ021	77	ZB5FA38	79	ZB5FD29	90	ZB5FH03C0	85	ZB5FL234	81
ZB5AZ022	77		83	ZB5FD29C0	90	ZB5FH3C0	85	ZB5FL235	81
ZB5AZ023	77	ZB5FA38C0	79	ZB5FD39	90	ZB5FH04	85	ZB5FL432	81
ZB5AZ024	77		83	ZB5FD39C0	90	ZB5FH4	85	ZB5FL432C0	81
ZB5AZ025	77	ZB5FA46	79	ZB5FD39C0	90	ZB5FH4C0	85	ZB5FL433	81
ZB5AZ026	77	ZB5FA46C0	79	ZB5FD49	90	ZB5FH04C0	85	ZB5FL434	81
ZB5AZ31	112	ZB5FA48	79	ZB5FD49C0	90	ZB5FH4C0	85	ZB5FL435	81
ZB5AZ079	106		83	ZB5FD59	90	ZB5FH05	85	ZB5FSZ3	95
ZB5AZ101	101	ZB5FA48C0	79	ZB5FD59C0	90	ZB5FH5	85	ZB5FV013	93
ZB5AZ102	101		83	ZB5FD79	90	ZB5FH05C0	85	ZB5FV013C0	93
ZB5AZ103	56	ZB5FA56	79	ZB5FD79C0	90	ZB5FH5C0	85	ZB5FV033	93
	101	ZB5FA56C0	79	ZB5FD89	90	ZB5FH06	85	ZB5FV033C0	93
ZB5AG3C0	56	ZB5FA58	79	ZB5FD89C0	90	ZB5FH6	85	ZB5FV043	93
ZB5AZ104	101		83	ZB5FD9C0	90	ZB5FH06C0	85	ZB5FV043C0	93
ZB5AZ105	101	ZB5FA58C0	79	ZB5FG0	89	ZB5FH6C0	85	ZB5FV053	93
ZB5AZ106	101		83	ZB5FG0C0	89	ZB5FH013	86	ZB5FV053C0	93
ZB5AZ107	101	ZB5FA66	79	ZB5FG0D	90	ZB5FH13	86	ZB5FV063	93
ZB5AZ141	101	ZB5FA66C0	79	ZB5FG1	89	ZB5FH013C0	86	ZB5FV063C0	93
ZB5AZ141	101	ZB5FA68	79	ZB5FG1D	90	ZB5FH13C0	86	ZB5FV083	93
ZB5AZ902	112		83	ZB5FG02	89	ZB5FH033	86	ZB5FV083C0	93
ZB5AZ903	112	ZB5FA131	81	ZB5FG2	89	ZB5FH33	86	ZB5FW113	84
ZB5AZ905	112	ZB5FA133	81	ZB5FG2C0	89	ZB5FH033C0	86	ZB5FW113C0	84
ZB5AZ1013	107	ZB5FA136	81	ZB5FG2D	90	ZB5FH33C0	86	ZB5FW133	84
ZB5AZ1015	104	ZB5FA141	81	ZB5FG02D	90	ZB5FH043	86	ZB5FW133C0	84
ZB5AZ1023	107	ZB5FA142	81	ZB5FG3	89	ZB5FH43	86	ZB5FW143	84
ZB5AZ1025	104	ZB5FA145	81	ZB5FG3D	90	ZB5FH043C0	86	ZB5FW143C0	84
ZB5AZ1033	107	ZB5FA145	81	ZB5FG03D	90	ZB5FH053	86	ZB5FW153	84
ZB5AZ1035	104	ZB5FA232	81	ZB5FG4	89	ZB5FH053C0	86	ZB5FW153C0	84
ZB5AZ1043	107	ZB5FA233	81	ZB5FG4C0	89	ZB5FH53	86	ZB5FW163	84
ZB5AZ1045	104	ZB5FA234	81	ZB5FG4D	90	ZB5FH053C0	86	ZB5FW163C0	84
ZB5AZ1045	104	ZB5FA235	81	ZB5FG04D	90	ZB5FH53C0	86	ZB5FW183	84
ZB5AZ1053	107	ZB5FA245	81	ZB5FG5	89	ZB5FH063	86	ZB5FW183C0	84
ZB5AZ1055	104	ZB5FA331	81	ZB5FG05	89	ZB5FH63	86	ZB5FW313	83
ZB5AZ1715626001	112	ZB5FA331C0	81	ZB5FG05C0	89	ZB5FH063C0	86	ZB5FW313C0	83
ZB5AZ1715626002	112	ZB5FA333	81	ZB5FG5D	90	ZB5FH63C0	86	ZB5FW333	83
ZB5AZ1715626003	112	ZB5FA334	81	ZB5FG05D	90	ZB5FH083	86	ZB5FW333C0	83
ZB5FA0	79	ZB5FA334C0	81	ZB5FG6	89	ZB5FH83	86	ZB5FW343	83
ZB5FA0C0	79	ZB5FA335	81	ZB5FG6C0	89	ZB5FH083C0	86	ZB5FW343C0	83
ZB5FA1	79	ZB5FA335C0	81	ZB5FG6D	90	ZB5FH83C0	86	ZB5FW353	83
ZB5FA1C0	79	ZB5FA336	81	ZB5FG06D	90	ZB5FJ2	88	ZB5FW353C0	83
ZB5FA2	79	ZB5FA341	81	ZB5FG7	89	ZB5FJ2C0	88	ZB5FW363	83
ZB5FA2C0	79	ZB5FA342	81	ZB5FG7C0	89	ZB5FJ3	88		
ZB5FA3	79	ZB5FA343	81	ZB5FG7D	90				

ZB5FW363C0	83	ZBAF9	68	ZBE5023	107	ZBVM1	102	ZBY2113	71
ZB5FW383	83	ZBAF131	94	ZBE5043	107	ZBVJ1	102	ZBY2114	71
ZB5FW383C0	83	ZBAF133	94	ZBE7016	106	ZBVJ15	105	ZBY2123	71
ZB5FW913	83	ZBAF136	94	ZBE7026	106	ZBVM1	102	ZBY2126	71
ZB5FW933	83	ZBAF137	94	ZBE10163	107	ZBVM15	105	ZBY02126	75
ZB5FW943	83	ZBAF138	94	ZBG421E	113	ZBY001	101		98
ZB5FW953	83	ZBAF141	94	ZBG455	113	ZBY001	107	ZBY2130	71
ZB5FW963	83	ZBAF142	94	ZBG455P	113	ZBY2H101	71	ZBY2134	71
ZB5FW983	83	ZBAF145	94	ZBG458A	113	ZBY4H101	71	ZBY2135	71
ZB5SKR01	66	ZBAF232	94	ZBG520E	113	ZBY6H101	74	ZBY2147	71
ZB5SKT01	66	ZBAF233	94	ZBG3131A	113	ZBY6H102	74	ZBY2164	71
ZB5SZ3	77	ZBAF234	94	ZBGK	113	ZBY8L140	43	ZBY2166	71
ZB5SZ3C0	77	ZBAF235	94	ZBGP	113	ZBY8L330	43	ZBY2166C0	71
ZB5SZ5	77	ZBAF245	94	ZBP0	70	ZBY9W2B101	42	ZBY2178	71
ZBA1	68	ZBAF331	94	ZBP0A	70	ZBY9W2B130	42	ZBY02178	75
ZBA2	68	ZBAF333	94	ZBP012	70	ZBY9W2B140	42		98
ZBA3	68	ZBAF334	94	ZBP013	70	ZBY9W2B230	42	ZBY2178C0	71
ZBA4	68	ZBAF335	94	ZBP014	70	ZBY9W2B330	42	ZBY2179	71
ZBA5	68	ZBAF336	94	ZBP015	70	ZBY9W2B430	42	ZBY2185	71
ZBA6	68	ZBAF337	94	ZBP016	70	ZBY9W2B501	42	ZBY02185	75
ZBA71	38	ZBAF338	94	ZBP017	70	ZBY9W2B630	42		98
ZBA72	38	ZBAF341	94	ZBPA	70	ZBY9W2G101	42	ZBY2186	71
ZBA73	38	ZBAF342	94	ZBSP1	77	ZBY9W2G130	42	ZBY2186C0	71
ZBA74	38	ZBAF343	94	ZBSP2	77	ZBY9W2G140	42	ZBY2303	72
ZBA75	38	ZBAF344	94	ZBSP3	77	ZBY9W2G230	42	ZBY2303C0	72
ZBA76	38	ZBAF432	94	ZBV5B	103	ZBY9W2G330	42	ZBY2304	71
ZBA131	69	ZBAF433	94	ZBV6	111	ZBY9W2G430	42	ZBY02304	75
ZBA145	69	ZBAF434	94	ZBV011	70	ZBY9W2G630	42		98
ZBA232	69	ZBAF435	94	ZBV013	70	ZBY9W2M101	42	ZBY2304C0	71
ZBA234	69	ZBAF639	94	ZBV014	70	ZBY9W2M130	42	ZBY2305	72
ZBA245	69	ZBAF2934	94	ZBV015	70	ZBY9W2M140	42	ZBY2306	72
ZBA331	69	ZBAF2935	94	ZBV016	70	ZBY9W2M230	42	ZBY2311	72
ZBA333	69	ZBD8D1	113	ZBV017	70	ZBY9W2M330	42	ZBY2312	72
ZBA334	69	ZBDA185	113	ZBV18B1	103	ZBY9W2M430	42	ZBY2313	72
ZBA335	69	ZBDD2	113	ZBV18B3	103	ZBY9W2M630	42	ZBY2314	72
ZBA336	69	ZBE000	115	ZBV18B4	103	ZBY9W3B101	42	ZBY2322	72
ZBA343	69	ZBE101	101	ZBV18B5	103	ZBY9W3B130	42	ZBY2323	72
ZBA344	69	ZBE102	101	ZBV18B6	103	ZBY9W3B140	42	ZBY2326	72
ZBA346	69	ZBE201	101	ZBV18G1	103	ZBY9W3B230	42	ZBY2330	72
ZBA432	69	ZBE202	101	ZBV18G3	103	ZBY9W3B330	42	ZBY2334	72
ZBA434	69	ZBE203	101	ZBV18G4	103	ZBY9W3B430	42	ZBY2364	72
ZBA435	69	ZBE204	101	ZBV18G5	103	ZBY9W3B501	42	ZBY2366	72
ZBA639	69	ZBE205	101	ZBV18G6	103	ZBY9W3B630	42	ZBY2367	72
ZBA708	38	ZBE302	101	ZBV18M1	103	ZBY9W101	42	ZBY2367C0	72
ZBA709	38	ZBE501	101	ZBV18M3	103	ZBY0101	75	ZBY2385	72
ZBA710	38	ZBE502	101	ZBV18M4	103		98	ZBY4100	75
ZBA2934	69	ZBE503	101	ZBV18M5	103	ZBY0102	75		98
ZBA2935	69	ZBE504	101	ZBV18M6	103		98	ZBY4101	71
ZBA7131	38	ZBE505	101	ZBV0113	70	ZBY0123	71	ZBY4101C0	71
ZBA7134	38	ZBE701	106	ZBV0133	70	ZBY1101	76	ZBY5100	74
ZBA7138	38	ZBE702	106	ZBV0143	70		98	ZBY5101	74
ZBA7232	38	ZBE1013	107	ZBV0153	70	ZBY1147	76	ZBY5102	74
ZBA7235	38	ZBE1015	104	ZBV0163	70		98	ZBY6101	74
ZBA7237	38	ZBE1016	101	ZBVB1	102	ZBY2101	71	ZBY6101C0	74
ZBA7331	38	ZBE1016P	101	ZBVB15	105	ZBY2101C0	71	ZBY6102	74
ZBA7335	38	ZBE1016P3	107	ZBVB17	106	ZBY2103	71	ZBY6102C0	74
ZBA7432	38	ZBE1023	107	ZBVB37	106	ZBY02103	75	ZBY8101	44
ZBAF1	68	ZBE1025	104	ZBVB47	106		98	ZBY8130	46
ZBAF2	68	ZBE1026	101	ZBVB57	106	ZBY2103C0	71	ZBY8160	44
ZBAF3	68	ZBE1026P	101	ZBVB67	106	ZBY2104	71	ZBY8230	46
ZBAF4	68	ZBE1026P3	107	ZBVBG1	102	ZBY2104C0	71	ZBY8330	46
ZBAF5	68	ZBE2033	107	ZBVG1	102	ZBY2107	71	ZBY8430	46
ZBAF6	68	ZBE2053	107	ZBVG15	105	ZBY2108	71	ZBY8630	46
						ZBY2111	71	ZBY9101	44

ZBY9101M	48	ZBYFP2178	97	ZBYP2367C0	73
ZBY9120	43	ZBYFP2178C0	97	ZBYP6101	74
	46	ZBYFP2186	97	ZBYP6101C0	74
ZBY9121	43	ZBYFP2186C0	97	ZBZ001	101
	46	ZBYFP2303	97		107
ZBY9130M	48	ZBYFP2303C0	97	ZBZ003	115
ZBY9130T	47	ZBYFP2304	97	ZBZ006	106
ZBY9140M	48	ZBYFP2304C0	97	ZBZ007	115
ZBY9140T	47	ZBYFP2367	97	ZBZ010	106
ZBY9141	45	ZBYFP2367C0	97	ZBZ012	106
ZBY9142	45	ZBYFP6101	97	ZBZ28	49
ZBY9160	44	ZBYFP6101C0	97		50
ZBY9160M	48	ZBYLEG101000	114	ZBZ32	71
ZBY9220	43	ZBYLEG101001	114	ZBZ32C0	71
	46	ZBYLEG201000	114	ZBZ33	74
ZBY9230M	48	ZBYLEG201001	114	ZBZ33C0	74
ZBY9230T	47	ZBYLEG301000	114	ZBZ34	71
ZBY9260	44	ZBYLEG301001	114	ZBZ35	74
ZBY9260M	48	ZBYLEG302000	114	ZBZ58	49
ZBY9320	43	ZBYLEG302001	114		50
	46	ZBYLEG303000	114	ZBZ60	49
ZBY9330M	48	ZBYLEG303001	114	ZBZ60	51
ZBY9330T	47	ZBYLEG304000	114	ZBZ1600	47
ZBY9360	44	ZBYLEG304001	114	ZBZ1602	47
ZBY9360M	48	ZBYLEG401000	114	ZBZ1604	47
ZBY9420	43	ZBYLEG401001	114	ZBZ1605	47
	46	ZBYLEG402000	114	ZBZ1606	47
ZBY9430M	48	ZBYLEG402001	114	ZBZ1902	51
ZBY9460M	48	ZBYLEG501000	114	ZBZ2102	49
ZBY9530M	48	ZBYLEG501001	114	ZBZ3605	47
ZBY9620	43	ZBYLEG502000	114	ZBZF32	96
	46	ZBYLEG502001	114	ZBZF33	96
ZBY9630M	48	ZBYLEG503000	114	ZBZG156	103
ZBY9730M	48	ZBYLEG503001	114	ZBZM156	103
ZBY9830M	48	ZBYLEG504000	114	ZD5PA12	67
ZBYF2101	96	ZBYLEG504001	114	ZD5PA14	67
ZBYF2101C0	96	ZBYM2101	73	ZD5PA22	67
ZBYF2103	96	ZBYM2103	73	ZD5PA24	67
ZBYF2103C0	96	ZBYM2104	73	ZD5PA103	67
ZBYF2166	96	ZBYM2166	73	ZD5PA203	67
ZBYF2166C0	96	ZBYM2178	73		
ZBYF2178	96	ZBYM2186	73		
ZBYF2178C0	96	ZBYM2303	73		
ZBYF2186	96	ZBYM2304	73		
ZBYF2186C0	96	ZBYM2367	73		
ZBYF2303	96	ZBYM6101	74		
ZBYF2303C0	96	ZBYP2101	73		
ZBYF2304	96	ZBYP2101C0	73		
ZBYF2304C0	96	ZBYP2103	73		
ZBYF2367	96	ZBYP2103C0	73		
ZBYF2367C0	96	ZBYP2104	73		
ZBYF4101	96	ZBYP2104C0	73		
ZBYF4101C0	96	ZBYP2166	73		
ZBYF6101	96	ZBYP2166C0	73		
ZBYF6101C0	96	ZBYP2178	73		
ZBYF6102	96	ZBYP2178C0	73		
ZBYF6102C0	96	ZBYP2186	73		
ZBYFP2101	97	ZBYP2186C0	73		
ZBYFP2101C0	97	ZBYP2303	73		
ZBYFP2103	97	ZBYP2303C0	73		
ZBYFP2103C0	97	ZBYP2304	73		
ZBYFP2104	97	ZBYP2304C0	73		
ZBYFP2104C0	97	ZBYP2367	73		
ZBYFP2166	97				
ZBYFP2166C0	97				

Life Is On



Learn more about our products at  
[www.se.com](http://www.se.com)

The information provided in this documentation contains general descriptions and/or technical characteristics of the performance of the products contained herein. This documentation is not intended as a substitute for and is not to be used for determining suitability or reliability of these products for specific user applications. It is the duty of any such user or integrator to perform the appropriate and complete risk analysis, evaluation and testing of the products with respect to the relevant specific application or use thereof. Neither Schneider Electric nor any of its affiliates or subsidiaries shall be responsible or liable for misuse of the information contained herein.

Design: Schneider Electric  
Photos: Schneider Electric

**Schneider Electric Industries SAS**

Head Office  
35, rue Joseph Monier - CS 30323  
F-92500 Rueil-Malmaison Cedex  
France

DIA5ED2121213EN  
September 2022 - V16.1