



ENGLISH

Datasheet

ABS Instrument Case, Grey, 150 x 80 x 60mm

RS Stock number 219-346



Description:

Plastic enclosure, dark grey colour, made of heat resistant high-impact plastic UL-94V0. Provides protection against dust and moisture according to the standard IP54. Printed circuit boards may be horizontally or vertically mounted.

Specifications:

Colour:	Dark grey
Body Material:	ABS
External Dimensions:	150 (length) x 80 (width) x 60 (height)mm
IP Rating:	IP54
Possibility of installation of printed circuit boards:	Horizontally and vertically, racks and rails

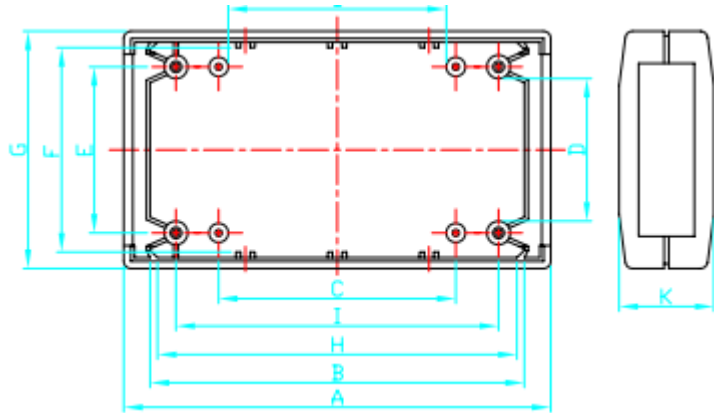
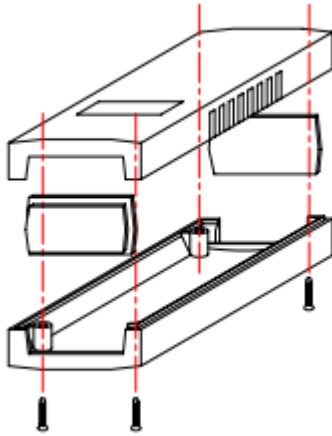

Dimensions: mm

A	150
B	138
C	110
D	46
E	55
F	64
G	80
H	138
I	128
J	100
K	60