



Datasheet

RS PRO Cable Clamp 3/8"

Stock number: 172-0843

EN



DIMENSIONS	TOLERANCE
<4mm	±0.20
4mm~15mm	±0.30
15mm~30mm	±0.40
30mm~50mm	±0.50

REVISIONS			
REV	DESCRIPTION	DATE	BY
01	NEW DRAWING	2016-8-28	Jack Xu

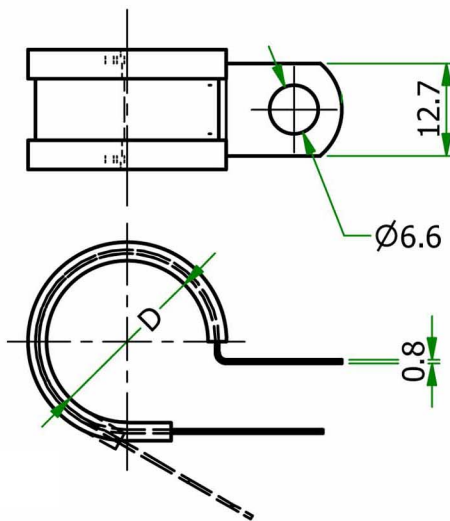

NOTES:
 1.MATERIAL:
 Cold Rolled Steel-- Silver
 Cushion:RUBBER-- BLACK
 2.HOLDING DIA. ØD=9.53mm

Unit:mm

SCALE	--	PART NAME	Hose Clamp
COLOR	SEE NOTES	PART NO.	172-0843
DRAWN	ALEX	MATERIAL	SEE NOTES
CHECK	JACK	DRAWING NO.	KS180710-4
APPROVED	GARY	DRAWING DATE	2016-8-28