

## Datasheet

# RS PRO BATTERY HOLDER, FOR CR2032 SMT TYPE COLOR: BROWN

Stock No: **2378347, 2378348**



## Product Details:

RS PRO Battery Holders, Battery Snaps, Spring Connectors, and Mobile Battery Connectors are designed to create connections and contain batteries in electronic equipment. This series includes battery holders and coin cell holders for AAA, AA, C, D, 9V and lithium coin cells. Adam Tech produces this series in a variety of terminations such as through hole PCB leads, SMT leads, wire leads and solder lugs. Custom lead lengths on wire configurations are also available. Our superior retention holders are molded of UL-94V0 or UL-94HB material with spring steel contacts and perform extremely well under normal or adverse environment conditions.

## Features & Benefits:

- Single and Multiple Cell
- Reliable spring tension contacts assures low contact resistance
- Rugged construction
- Light Weight

## SPECIFICATIONS:

### Material:

Housing: Hi-temp thermoplastic, Color: Brown

Contact: Phosphor Bronze, Gold plated

### Electrical:

Contact resistance: 30 mohms max

Insulation resistance: 1,000 Megaohms ohms min

Dielectric Voltage: 500 VAC one sec level

### Temperature Rating:

Operating temperature: -25°C to +85°C

### Environmental:

Lead free, RoHS compliant

## Dimensional line drawings

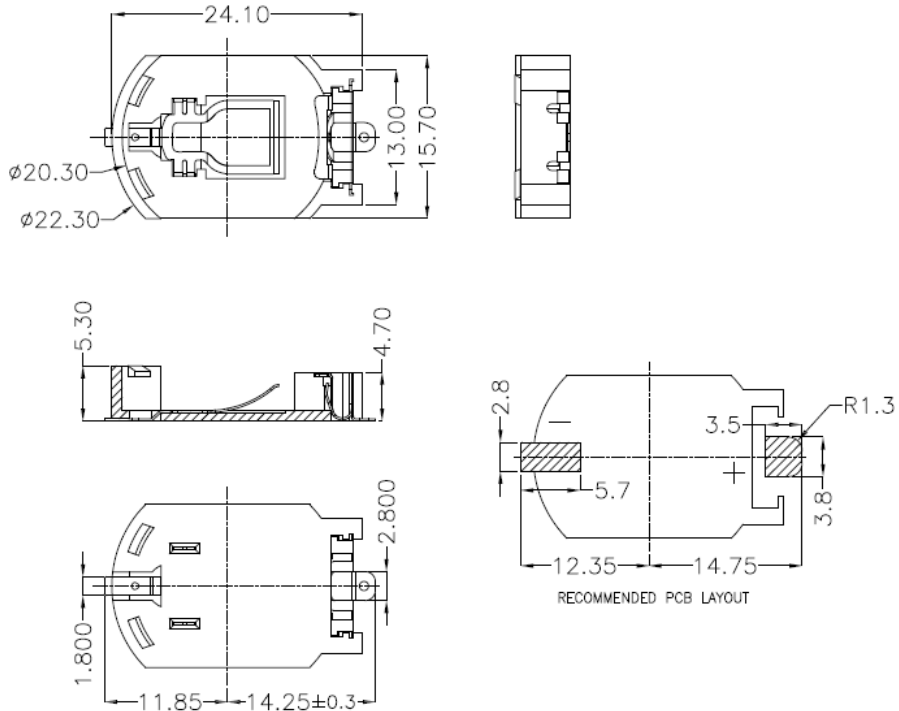

# General

Extra page for more complex