



Datasheet

ENGLISH

RS PRO DC Motor, 19.8 W, 4.5 - 15 V, 12000 gcm, 20 rpm, 6mm Shaft Diameter

Stock No: 752-1986



Specifications:

Output Speed	20 rpm
Supply Voltage	4.5 - 15 V dc
Maximum Output Torque	12000 g.cm
DC Motor Type	Brushed
Shaft Diameter	6mm
Power Rating	19.8 W
Gearhead Type	Planetary
Length	95.7mm
Width	35.8mm
Current Rating	2.81 A
Weight	332g

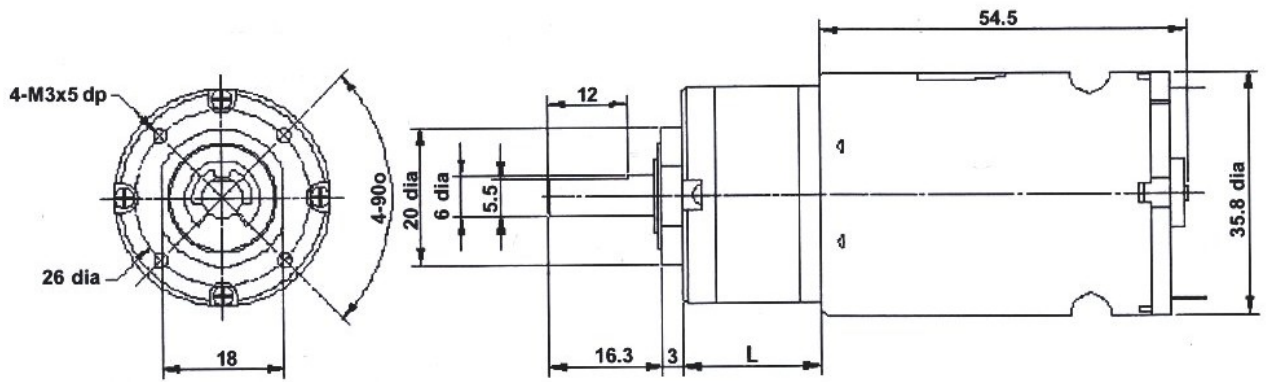

Operating relative humidity 20% ~ 85%
 Operating temperature range -10°C ~ +60°C

Ratio	L
721:1	41.2mm

Gearbox Housing material	Metal
Backlash at no-load	< 2.5°
Bearing at output	Sleeve bearings
Radial load (10mm from flange)	< 3 kgf
Shaft axial load	< 2.5 kgf
Shaft press fit force max	< 10 kgf
Radial play of shaft	< 0.05mm
Thrust play of shaft	< 0.3mm

Reduction Ratio	Rated tolerance Torque	Max momentary Tolerance Torque	Efficiency
1/721	12 kgf-cm Max.	36 kgf-cm	50%

Reduction Table RPM SUPPLY VOLTAGE	4.5v	6v	9v	12v	15v
752-1983	8	10	15	20	25

Note: Motor speeds may vary by (+) or (-) 12.5%