

Datasheet

RS Pro M12 Connector Female Angled

RS Pro: 877-1022



General Specification	
Rated Operational Voltage	250V
Current Rating	4A
Insulation Resistance	$\geq 100\text{M}\Omega$
Temperature Range	-25°C ... +75°C
Degree Of Protection	IP67
Material Specification	
Grip Material	PU
Contact	Cu-Zn
Contact Plating	Gold Plated
Contact Carrier	Nylon 66
O-Ring	Neoprene
Grip Colour	Black
Coupling Nut	Brass Nickel-Plated

Cable Specification	
Cable Length-L	2m
Cable Type	3 Core PVC Multi Strand
Sheath Colour	Black
Cross Section of Wire	0.34sq. mm
Core Dia	1.4mm
Cable Dia	4.5 ± 0.1mm
Termination	Partially Stripped

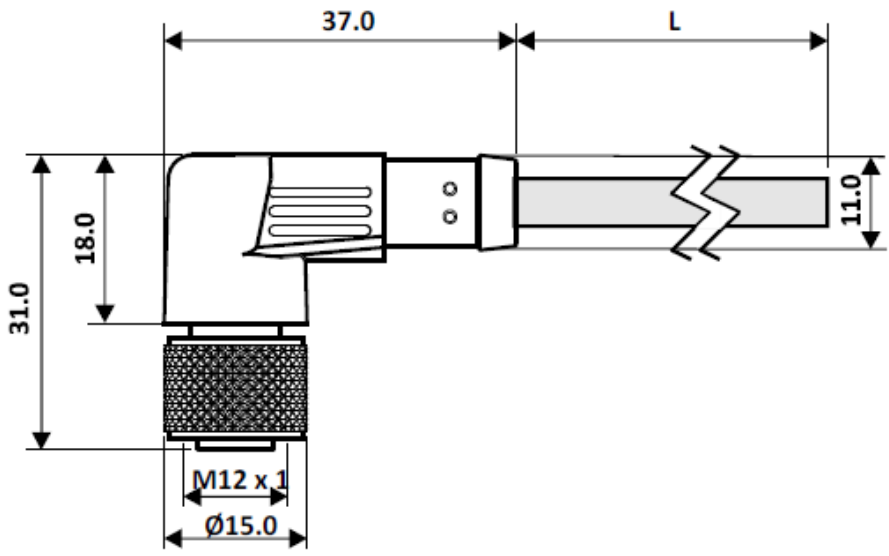

Pin Assignment

