

FEATURES

- Durable and rugged design
- Reliable with a high performance
- Lightweight with a compact space-saving high-density design
- Rugged aluminium shell for extra strength and EMI/RFI shielding
- Interface seal isolates contacts from one another
- Gold plated pin and receptacle contacts
- Pre-terminated with 18-inch wire leads

RS PRO 25 Way Panel Mount D-sub Connector Socket

RS Stock No.: 245-0918



RS Professionally Approved Products bring to you professional quality parts across all product categories. Our product range has been tested by engineers and provides a comparable quality to the leading brands without paying a premium price.

Product Description

From RS PRO a durable high density, high-performance Micro-D D-Sub connector designed for use in rugged and demanding environments. The metal shell of this connector provides both EMI & RFI shielding. This d-sub also features an interfacial seal which offers protection to the contacts against moisture and humidity. This D-sub connector has a compact design with a contact pitch of just 1.27mm which means it is ideal for use in applications where weight and space need to be kept at a minimum.

General Specifications

Number Of Contacts	25
Gender	Female
Body Orientation	Straight
Mounting Type	Panel Mount
D Connector	Micro-D
Termination Method	Solder
Housing Material	Aluminium
Dimensions	29.84mm x 7.57mm x 10.64mm
Contact Material	Copper Alloy
Contact Plating	Gold
Application	Networking and communications equipment, Data processing equipment, Sensors and data loggers, Industrial and medical equipment, Portable electric generation equipment, Aircraft and Spacecraft applications
Material Flammability Rating	UL94 V-0

Electrical Specifications

Current Rating	3.0A
Voltage Rating	250V
Contact Resistance	8 milliohms maximum
Dielectric Withstand Voltage	600VAC/RMS

Mechanical Specifications

Length	29.84mm
Width	7.57mm
Depth	10.64
Maximum Mating Force	7.10kg
Minimum Unmating Force	0.35kg
Individual Contact	6 oz. (170.40 g) maximum insertion; 0.5 oz. (14.20 g) minimum withdrawal

Operation Environment Specifications

Maximum Operating Temperature	+135°C
Minimum Operating Temperature	-55°C

Approvals

Compliance/Certifications	UL94V-0
----------------------------------	---------

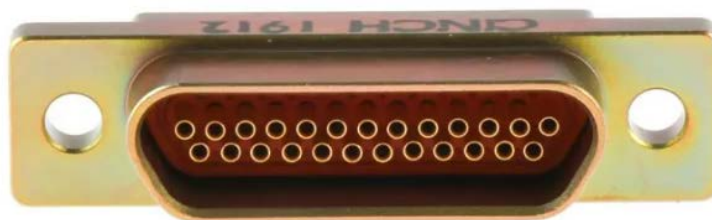



No. of Contacts	Maximum Mating Force		Minimum Unmating Force	
	Lb.	Kg	Lb.	Kg
9	5.63	2.56	.28	.13
15	9.38	4.26	.47	.21
21	13.13	5.96	.66	.30
25	15.63	7.10	.78	.35
31	19.38	8.80	.97	.44
37	23.13	10.50	1.16	.53
51	31.88	14.47	1.59	.72
100	62.50	28.38	3.13	1.42

Contact Arrangements

(Face view of pin insert)
(Use reverse order for socket side)

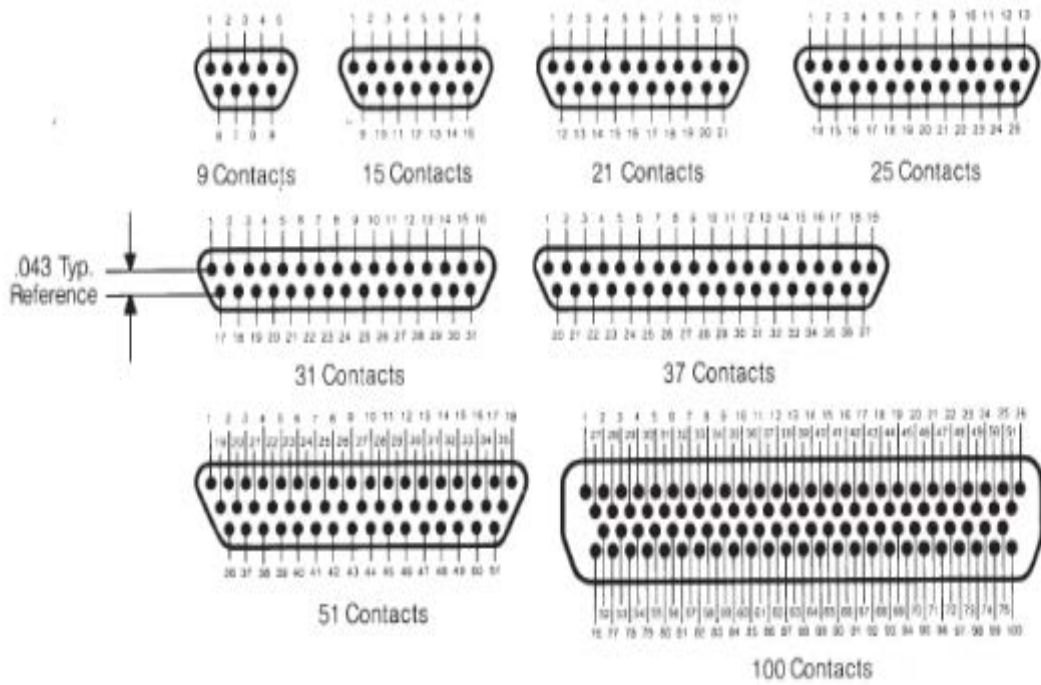

Connector Dimensions - Metal Shell

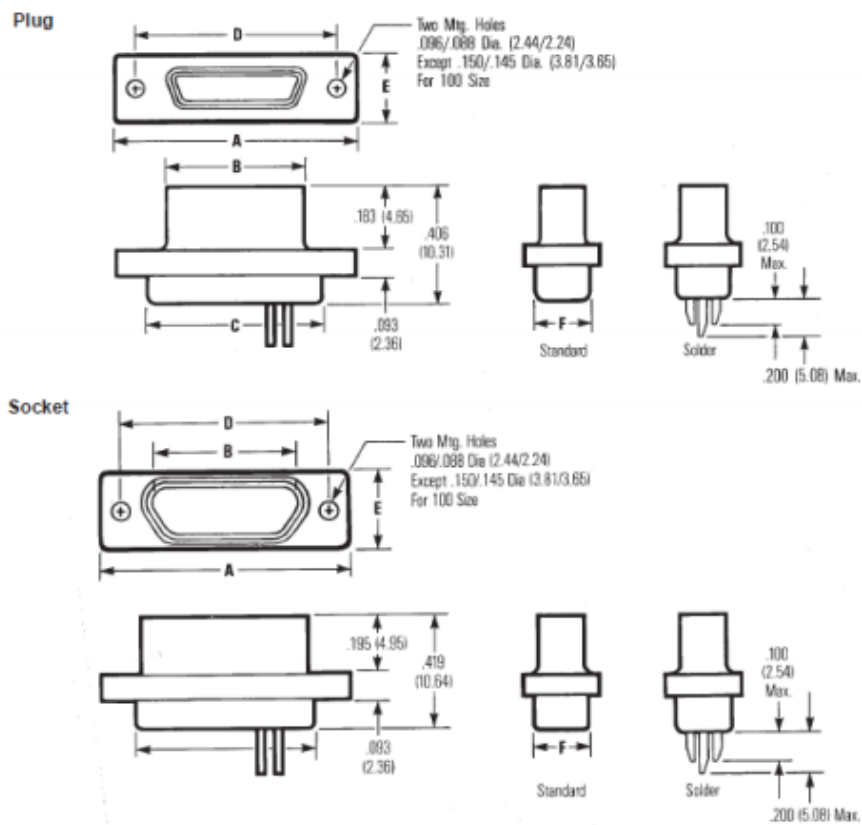

No. of Contacts	A		B Max.		C +.010 (.254) -.018 (.457)		D		E		F Max.	
	± .010 (.254) in	mm	in	mm	in	mm	± .005 (.127) in	mm	± .010 (.254) in	mm	in	mm
9 Plug	.775	19.68	.333	8.46	.390	9.91	.565	14.35	.298	7.57	.270	6.86
9 Socket	.775	19.68	.396	10.06	.390	9.91	.565	14.35	.298	7.57	.270	6.86
15 Plug	.925	23.50	.483	12.27	.540	13.72	.715	18.16	.298	7.57	.270	6.86
15 Socket	.925	23.50	.546	13.87	.540	13.72	.715	18.16	.298	7.57	.270	6.86
21 Plug	1.075	27.30	.633	16.08	.690	17.53	.865	21.97	.298	7.57	.270	6.86
21 Socket	1.075	27.30	.696	17.68	.690	17.53	.865	21.97	.298	7.57	.270	6.86
25 Plug	1.175	29.84	.733	18.62	.790	20.07	.965	24.51	.298	7.57	.270	6.86
25 Socket	1.175	29.84	.796	20.22	.790	20.07	.965	24.51	.298	7.57	.270	6.86
31 Plug	1.325	33.66	.883	21.16	.940	23.88	1.115	28.32	.298	7.57	.270	6.86
31 Socket	1.325	33.66	.946	24.03	.940	23.88	1.115	28.32	.298	7.57	.270	6.86
37 Plug	1.475	37.46	1.033	26.24	1.090	27.69	1.265	32.13	.298	7.57	.270	6.86
37 Socket	1.475	37.46	1.096	27.84	1.090	27.69	1.265	32.13	.298	7.57	.270	6.86
51 Plug	1.425	36.20	.983	24.97	1.040	26.42	1.215	30.86	.341	8.66	.310	7.87
51 Socket	1.425	36.20	1.046	26.57	1.040	26.42	1.215	30.86	.341	8.66	.310	7.87
100 Plug	2.160	54.86	1.383	35.13	1.432	36.38	1.800	45.71	.384	9.75	.360	9.15
100 Socket	2.160	54.86	1.446	36.73	1.432	36.38	1.800	45.71	.384	9.75	.360	9.15

Panel Mounting Dimensions

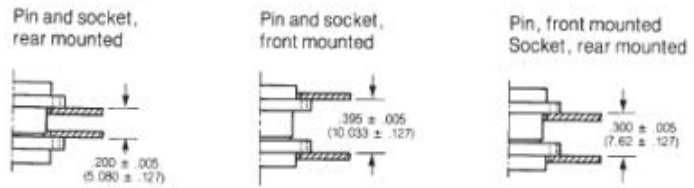

Panel Cutout Dimensions

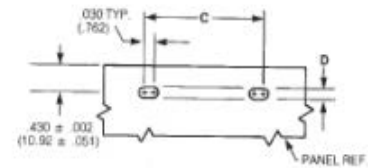
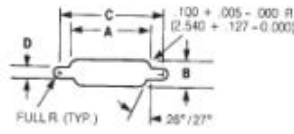
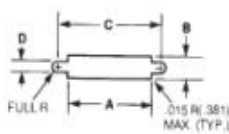

No. of Contacts	Figure Number	A		B		C		D	
		+0.004	(.101)	+0.004	(.101)	+0.005	(.127)	+0.005	(1.27)
		-.000	(.000)	-.000	(.000)	-.000	(.000)	-.000	(.000)
		in	mm	in	mm	in	mm	in	mm
9	1	.408	10.36	.270	6.86	.570	14.48	-	-
	2	.408	10.36	.256	6.50	.570	14.48	.089	2.26
	3	-	-	-	-	.570	14.48	-	-
15	1	.558	14.17	.270	6.86	.720	18.29	-	-
	2	.558	14.17	.256	6.50	.720	18.29	.089	2.26
	3	-	-	-	-	.720	18.29	-	-
21	1	.708	17.98	.270	6.86	.870	22.10	-	-
	2	.708	17.98	.256	6.50	.870	22.10	.089	2.26
	3	-	-	-	-	.870	22.10	-	-
25	1	.808	20.52	.270	6.86	.970	24.64	-	-
	2	.808	20.52	.256	6.50	.970	24.64	.089	2.26
	3	-	-	-	-	.970	24.64	-	-
31	1	.958	24.33	.270	6.86	1.120	28.45	-	-
	2	.958	24.33	.256	6.50	1.120	28.45	.089	2.26
	3	-	-	-	-	1.120	28.45	-	-
37	1	1.108	28.14	.270	6.86	1.270	32.26	-	-
	2	1.108	28.14	.256	6.50	1.270	32.26	.089	2.26
	3	-	-	-	-	1.270	32.26	-	-
51	1	1.058	26.87	.315	8.00	1.220	30.99	-	-
	2	1.058	26.87	.300	7.62	1.220	30.99	.089	2.26
	3	-	-	-	-	1.220	30.99	-	-
100	1	1.450	36.84	.361	9.17	1.805	45.86	.117	2.97
	2	1.562	39.68	.338	8.58	1.805	45.86	.117	2.97
	3	-	-	-	-	1.805	45.86	.117	2.97