

Datasheet

RS 2.77mm Pitch 15 Way IDC D-sub Connector, Plug, Thermoplastic Shell

RS Stock number 642-4862

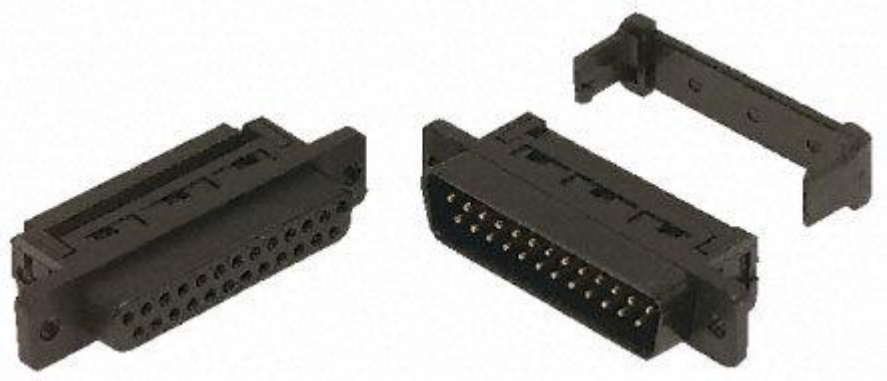

Dimensions: (mm)

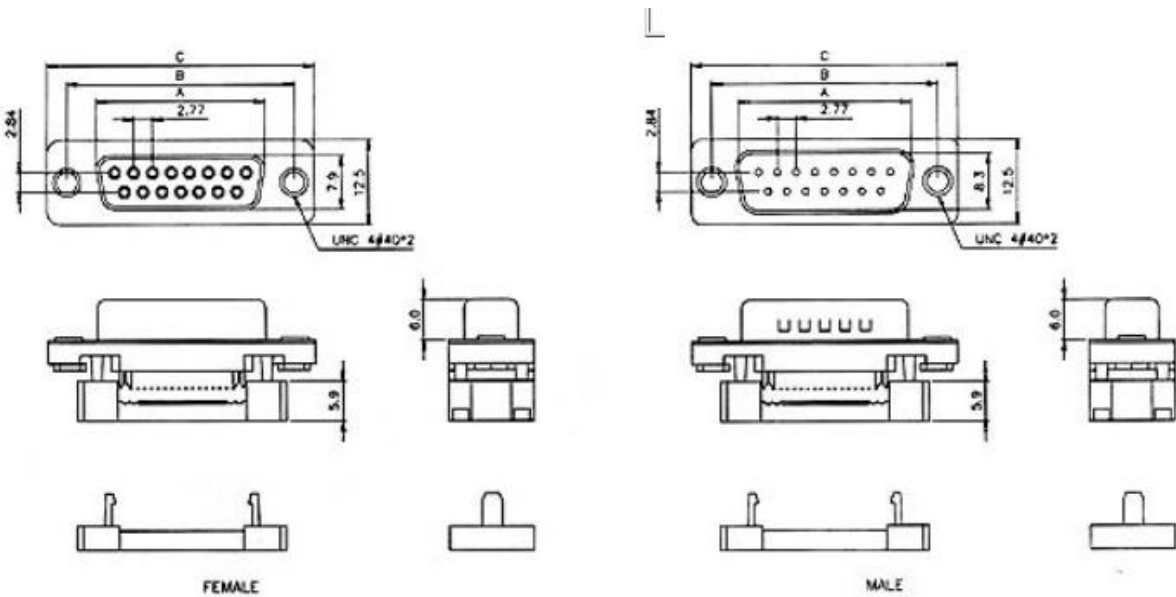

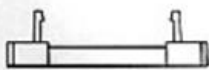
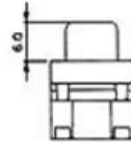
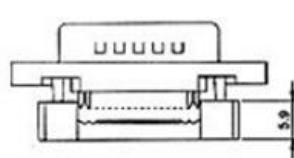
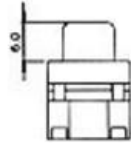
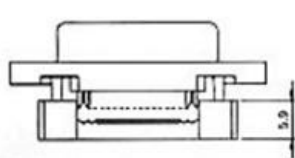
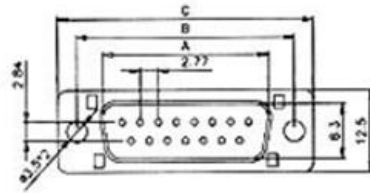
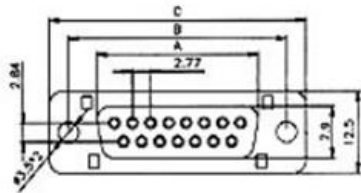

FEMALE FOR PLASTIC

MALE FOR PLASTIC

Process Option

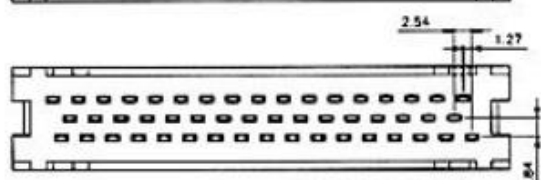
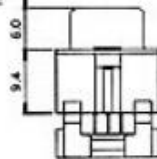
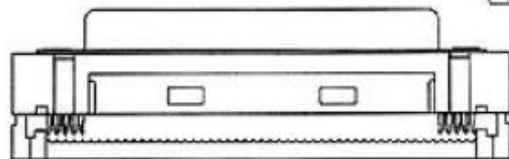
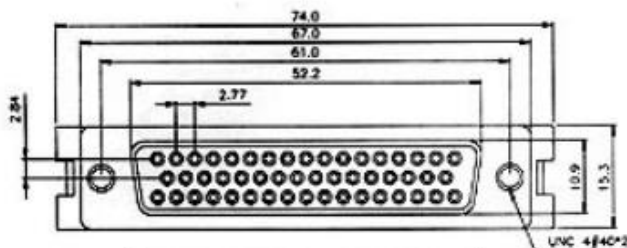

50 POSITION FEMALE

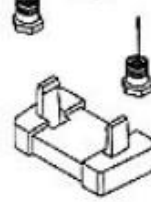
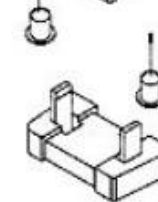
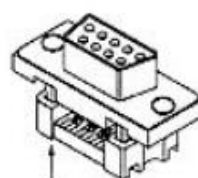

NON-THREAD RIVET

THREAD RIVET

Specification

- Contact Type: M= Male F=Female
- Contact Plating: S= Selective Gold G=Gold Flash
- Shell Option: A=Plastic Shell / B=Metal Shell / C=Metal W/Rivet / D= Metal W/Rivet
- S.R Option: A=W/O Strain Relief B=W/Strain Relief
- Process Option: A=Non accessories / B= Loose Hex- Screws / C= Fixed Hex Screws (4.8*12.0mm)