

# Heavy Duty Connector Inserts Standard

**multicomp** PRO

**RoHS  
Compliant**

## Specifications

### Housing

Rated Current	: 16A
Rated Voltage	: 500V
Rated Impulse Voltage	: 6KV
Pollution Degree	: 3
Insulation Resistance	: $\geq 10^{10}\Omega$
Material	: Polycarbonate
Temperature Range	: -40°C to +125°C
Mating Cycles	: $\geq 500$
Contact Material	: Copper
Contact Surface	: Silver plated / Gold plated
Contact Resistance	: $\leq 1m\Omega$
Tightening Torque	: 0.5Nm

### Screw Terminal

Wire Gauge	: 0.14~4mm <sup>2</sup>
AWG	: 26-14

### Crimp Terminal

Wire Gauge	: 0.14~4mm <sup>2</sup>
AWG	: 26-12



## 16A, 500V, 6 Pin, Insert

### Screw Terminal



MP009561

MP009560

### Crimp Terminal



MP009563

MP009562

### Diagram

Distance for contact max.21mm

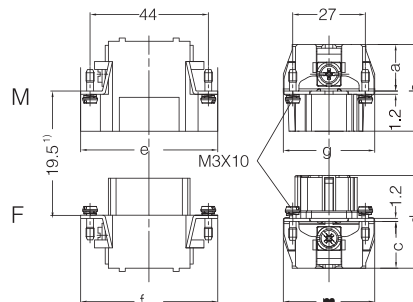

Contacts arrangement view from termination side

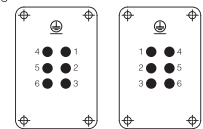

Panel cut out for inserts for use without Hoods/housings

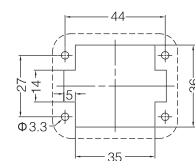

Part Number	Inserts	Terminal	a	b	e	g	c	d	f	m
MP009561	Male	Screw	16	32.4	51	34	16.8	34.5	50.5	34
MP009560	Female									
MP009563	Male	Crimp	18	33	51	34	18	35	50.5	34
MP009562	Female									

Dimensions : Millimetres

Newark.com/multicomp-pro  
Farnell.com/multicomp-pro  
sg.element14.com/b/multicomp-pro

**multicomp** PRO

# Heavy Duty Connector Inserts Standard



## 16A, 500V, 10 Pin, Insert

### Screw Terminal

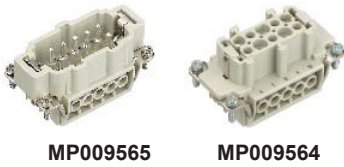

MP009565

MP009564

### Crimp Terminal



MP009567

MP009566

### Diagram

Distance for contact max.21mm

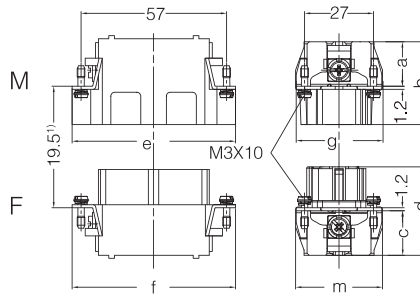

Contacts arrangement view from termination side

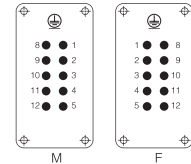

Panel cut out for inserts for use without Hoods/housings

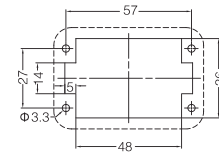

Part Number	Inserts	Terminal	a	b	e	g	c	d	f	m
MP009565	Male	Screw	16.5	32	64.5	34	16.8	34.2	64	34
MP009564	Female									
MP009567	Male	Crimp	18	33	64	34	17.5	35.2	64	34
MP009566	Female									

## 16A, 500V, 16 Pin, Insert

### Screw Terminal

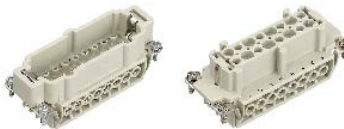

MP009569

MP009568

### Crimp Terminal



MP009571

MP009570

### Diagram

Distance for contact max.21mm

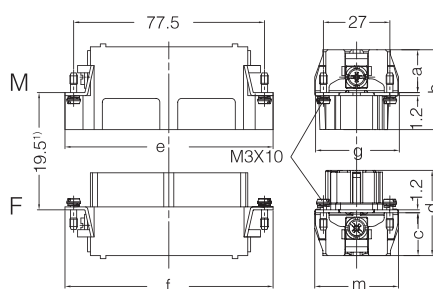

Contacts arrangement view from termination side

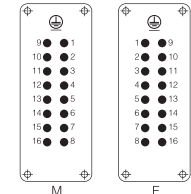

Panel cut out for inserts for use without Hoods/housings

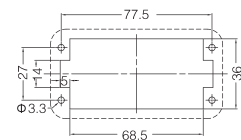

Part Number	Inserts	Terminal	a	b	e	g	c	d	f	m
MP009569	Male	Screw	17	32.5	84.2	34	17	34.5	84.2	33.5
MP009568	Female									
MP009571	Male	Crimp	18	33.5	84.5	34	18	35	84.5	34
MP009570	Female									

Dimensions : Millimetres

Newark.com/multicomp-pro  
 Farnell.com/multicomp-pro  
 sg.element14.com/b/multicomp-pro



# Heavy Duty Connector Inserts Standard

**multicomp** PRO

## 16A, 500V, 24 Pin, Insert

### Screw Terminal



MP009573

MP009572

### Crimp Terminal



MP009575

MP009574

### Diagram

Distance for contact max.21mm

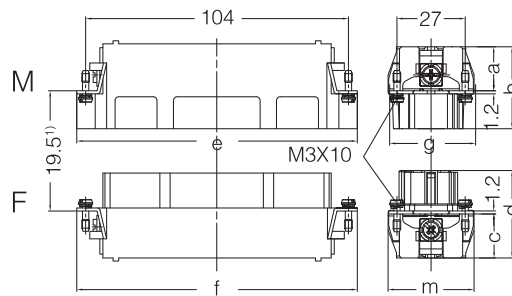

Contacts arrangement view from termination side

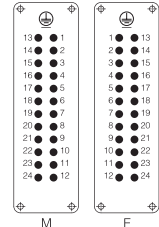

Panel cut out for inserts for use without Hoods/housings

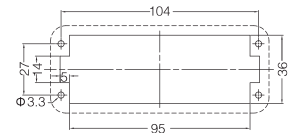

Part Number	Inserts	Terminal	a	b	e	g	c	d	f	m
MP009573	Male	Screw	17	32.5	111	33.5	17	34.5	111	33.5
MP009572	Female									
MP009575	Male	Crimp	18.3	33.5	111	34	18.3	35.5	111	34
MP009574	Female									

## 16A, 500V, 32 Pin, Insert

### Screw Terminal



MP009577

MP009576

### Crimp Terminal

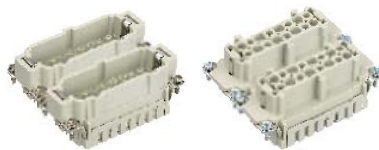

MP009579

MP009578

### Diagram

Distance for contact max.21mm

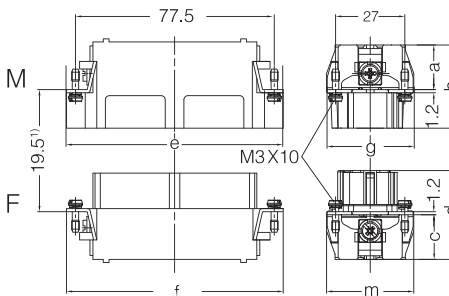

Contacts arrangement view from termination side

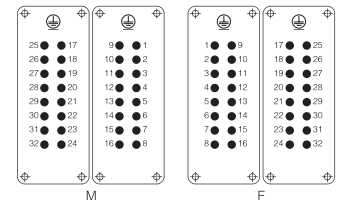

Panel cut out for inserts for use without Hoods/housings

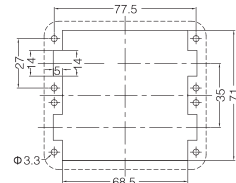

Part Number	Inserts	Terminal	a	b	e	g	c	d	f	m
MP009577	Male	Screw	17	32.5	84.2	34	17	34.5	84.2	33.5
MP009576	Female									
MP009579	Male	Crimp	18	33.5	84.5	34	18	35	84.5	34
MP009578	Female									

Dimensions : Millimetres

Newark.com/multicomp-pro  
Farnell.com/multicomp-pro  
sg.element14.com/b/multicomp-pro

**multicomp** PRO

# Heavy Duty Connector Inserts Standard

**multicomp** PRO

## 16A, 500V, 48 Pin, Insert

### Screw Terminal



MP009581

MP009580

### Crimp Terminal



MP009583

MP009582

### Diagram

Distance for contact max.21mm

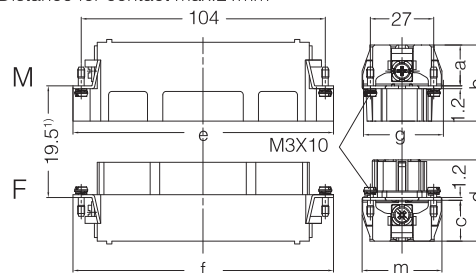

Contacts arrangement view from termination side

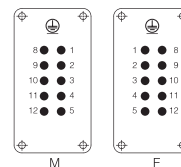

Panel cut out for inserts for use without Hoods/housings

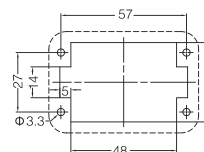

Part Number	Inserts	Terminal	a	b	e	g	c	d	f	m
MP009581	Male	Screw	17	32.5	111	33.5	17	34.5	111	33.5
MP009580	Female									
MP009583	Male	Crimp	18.3	33.5	111	34	18.3	35.5	111	34
MP009582	Female									

Dimensions : Millimetres

Newark.com/multicomp-pro  
Farnell.com/multicomp-pro  
sg.element14.com/b/multicomp-pro

**multicomp** PRO

# Heavy Duty Connector Inserts Standard



## Part Number Table

Description	Part Number
Heavy Duty Connector Insert, 16A, 500V, 6 Pin, Female, Screw Terminal	MP009560
Heavy Duty Connector Insert, 16A, 500V, 6 Pin, Female, Crimp Terminal	MP009562
Heavy Duty Connector Insert, 16A, 500V, 6 Pin, Male, Screw Terminal	MP009561
Heavy Duty Connector Insert, 16A, 500V, 6 Pin, Male, Crimp Terminal	MP009563
Heavy Duty Connector Insert, 16A, 500V, 10 Pin, Female, Screw Terminal	MP009564
Heavy Duty Connector Insert, 16A, 500V, 10 Pin, Female, Crimp Terminal	MP009566
Heavy Duty Connector Insert, 16A, 500V, 10 Pin, Male, Screw Terminal	MP009565
Heavy Duty Connector Insert, 16A, 500V, 10 Pin, Male, Crimp Terminal	MP009567
Heavy Duty Connector Insert, 16A, 500V, 16 Pin, Female, Screw Terminal	MP009568
Heavy Duty Connector Insert, 16A, 500V, 16 Pin, Female, Crimp Terminal	MP009570
Heavy Duty Connector Insert, 16A, 500V, 16 Pin, Male, Screw Terminal	MP009569
Heavy Duty Connector Insert, 16A, 500V, 16 Pin, Male, Crimp Terminal	MP009571
Heavy Duty Connector Insert, 16A, 500V, 24 Pin, Female, Screw Terminal	MP009572
Heavy Duty Connector Insert, 16A, 500V, 24 Pin, Female, Crimp Terminal	MP009574
Heavy Duty Connector Insert, 16A, 500V, 24 Pin, Male, Screw Terminal	MP009573
Heavy Duty Connector Insert, 16A, 500V, 24 Pin, Male, Crimp Terminal	MP009575
Heavy Duty Connector Insert, 16A, 500V, 32 Pin, Female, Screw Terminal	MP009576
Heavy Duty Connector Insert, 16A, 500V, 32 Pin, Female, Crimp Terminal	MP009578
Heavy Duty Connector Insert, 16A, 500V, 32 Pin, Male, Screw Terminal	MP009577
Heavy Duty Connector Insert, 16A, 500V, 32 Pin, Male, Crimp Terminal	MP009579
Heavy Duty Connector Insert, 16A, 500V, 48 Pin, Female, Screw Terminal	MP009580
Heavy Duty Connector Insert, 16A, 500V, 48 Pin, Female, Crimp Terminal	MP009582
Heavy Duty Connector Insert, 16A, 500V, 48 Pin, Male, Screw Terminal	MP009581
Heavy Duty Connector Insert, 16A, 500V, 48 Pin, Male, Crimp Terminal	MP009583

**Important Notice :** This data sheet and its contents (the "Information") belong to the members of the AVNET group of companies (the "Group") or are licensed to it. No licence is granted for the use of it other than for information purposes in connection with the products to which it relates. No licence of any intellectual property rights is granted. The Information is subject to change without notice and replaces all data sheets previously supplied. The Information supplied is believed to be accurate but the Group assumes no responsibility for its accuracy or completeness, any error in or omission from it or for any use made of it. Users of this data sheet should check for themselves the Information and the suitability of the products for their purpose and not make any assumptions based on information included or omitted. Liability for loss or damage resulting from any reliance on the Information or use of it (including liability resulting from negligence or where the Group was aware of the possibility of such loss or damage arising) is excluded. This will not operate to limit or restrict the Group's liability for death or personal injury resulting from its negligence. Multicomp Pro is the registered trademark of Premier Farnell Limited 2019.

