

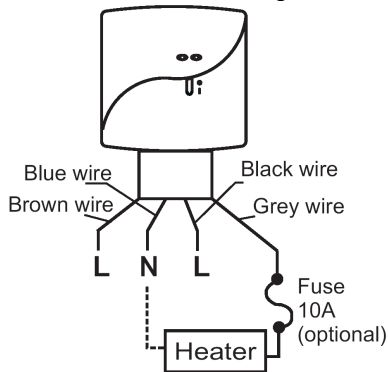

TABLE OF CONTENT

A. Installation and Mounting	2
1. Installation	3
2. Wiring	3
3. Mounting	3
B. Start/Reset	5
C. Normal Time Mode	5
D. Normal Time Setting Mode	6
E. Factory Defined Programs	7
F. Set Program	8
G. Temporary/Permanent Override Mode	9
H. Control Off/ Sleep Mode	11
I. Jumper Selection	12
J. Address Setting	13
K. Specification	13

10. Storage temperature: -10 - 60°C
11. Sensing Element: NTC thermistor

Terminal block connecting Label:



the receiver. Select the cooler option when a cooler is connected to the receiver.

J. Address setting:

In transmitter and receiver, there are dip switches to select the addresses. The receiver ignores the message which is sent by the transmitter with different address setting.

K. Specification:

1. Temperature measurement: 0.0 - 40°C(0.1°C/step)
2. Accuracy: $\pm 0.5^{\circ}\text{C}$
3. Temperature control range: 5.0 - 35.0°C (0.5°C/step)
4. Terminals: 2.5mm² cable
5. Electronic control: Type 2.B action
6. Transmitter—Battery: 2 x 1.5V AAA alkaline battery
7. Receiver—Input voltage: 240Vac
8. Receiver—Output voltage: 24..240Vac 50/60Hz
10(3)A max
9. Operating temperature: 0 - 50°C

RF Programmable Thermostat

1. The system includes one wireless thermostat controller plus one RF receiver.
2. Transmits up to 20 meter indoor.
3. Communicates at 868MHz(Europe Standard) and designed for unlicensed operation under FCC Part 15.

Warning:

1. If there is a dead zone in the RF communication. That means the receiver may not be able to receive the message from the transmitter. Before the installation, check the communication first. If the communication fails, relocate the receiver and transmitter location.
2. If the receiver has interference, set another transmitter address. Reset the transmitter and follow the set up instruction to reset the receiver.
3. It is recommended locate at least 30cm distance from any metal objects (including the metal box) and at least 2 meter from any electronic devices e.g. radio TV, PC,

etc. The metal objects or electronic devices maybe interfere with the RF communication, so maximum distance will be shorter.

4. Do not mount onto metal wall boxes.

A. Installation, Mounting:

Caution:

Turn off thermostat and the electrical devices (e.g. heater, cooler) which will be connected before installation.

It is highly recommended that the installation procedure is processed by trained personnel.

1. Installation Location:

The thermostat (Receiver and Transmitter) should be mounted on an inner wall 1.5m above the floor in position where it is readily affected by changes of the general room temperature with freely circulating air. Prevent direct exposure to sunlight; dripping or splashing area. Do not place this unit at a location where air circulation is low, or where it has great temperature changes (e.g. near door).

irrespective of the current setting temperature.

Control Off mode:

The LCD is fully turned off. The heater/ cooler is switched off, irrespective of the current control temperature setting.

I. Jumper selection:

Delay / No Delay jumper:

	Heater	Cooler
No delay	10sec	4mins
Delay	4mins	4mins

Choose the Delay option if compressor heat is connected.

12-hours / 24-hours mode jumper:

When the 12-hours option is selected, the time is shown in 12-hours mode. Otherwise, the time is shown in 24-hours mode.

Heater / Cooler jumper:

Select the heater option when a heater is connected to

Temporary Override Mode:

Temporary Override mode maintains until next program time is met.

Permanent Override Mode:

The room temperature will be maintained at the Override temperature until Override mode is released. Press <PRG> to release the Permanent Override mode.

H. Control Off / Sleep mode:

1. Press the <⏻> to select the sleep mode and control off mode.

The sequence is as below:

Normal Mode → Sleep Mode → Control Off Mode → Normal Mode →...

2. Press any other keys to exit the control off / sleep mode and return normal mode.

Sleep Mode:

At sleep mode, <Ⓞ> icon is displayed. Transmitter stops measuring and displaying the temperature. Only the

Do not place the thermostat near heat/cool generating sources.

2. Wiring:

Caution: Turn off the electrical devices and receiver before wiring.

There is 4-wire cable provided

Color	Connection
Brown	240Vac Live
Blue	240Vac Neutral
Black	240Vac Live
Grey	Device's power input

It is recommended that a 10A fuse is fitted at grey wire. (Please refer to the wiring diagram on the last page.)

3. Mounting:

Using the accessory screws and wall anchors provided, mount with the key-hole at the back.

The transmitter and receiver should be mounted on the wall and install the covers on them.

Install or replace the battery for transmitter:

Caution: Turn off the electrical devices and disconnect the supply to the appliances before replacing the batteries. Replace only with the same or equivalent type of batteries. Do not dispose the used batteries with household waste. Refer to your local area for the proper disposal.

Figure1

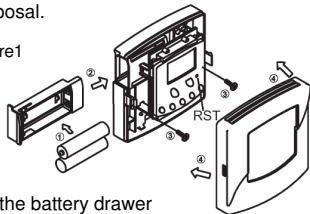

1. Pull out the battery drawer
2. Place the new batteries according to the marking on the battery drawer.
3. Dispose the old batteries properly.
4. Slide the battery drawer back to its position.
5. Check if the thermostat works properly or not. Press

5

Normal → Temporary Override → Permanent
Override → Normal → ...

Selecting the Temporary/ Permanent Override Mode

1. Press to change the mode from normal to Temporary Override. **T** icon will be displayed.
2. Press again, the mode changes from Temporary Override to Permanent Override mode. **P** icon will be displayed.
3. Press once, the mode changes from Permanent Override to normal mode.

Review and adjust the Override temperature:

1. Press , the Override temperature is shown.
2. Hold the , for 2 seconds, the Override temperature will flash.
3. Press , to adjust the Override temperature.
4. Press to exit the Override temperature setting.
Or transmitter will auto-return to normal mode after 10 seconds.

10

F. Set Program:

1. Press <PRG>, the hour will flash, press <▲>, <▼> to change the hour setting.
2. Press <PRG>, the minutes will flash, press <▲>, <▼> to change the minutes setting.
3. Press <PRG>, temperature will flash, press <▲>, <▼> to change the setpoint.
4. Press <PRG> to set the next program.
5. The program setting sequence is as below:
Mon~Fri (P1→ P2→ P3 → P4→P5→P6)→ Sat (P1→ P2→ P3 → P4→P5→P6)→ Sun (P1→ P2→ P3 → P4→P5→P6)→...
6. Press <←> to exit the program setting mode and return to the normal mode.
Or transmitter will auto-return to normal mode after 10 seconds.



G. Temporary / Permanent Override Mode:

1. There are two modes in the override mode (Temporary override and Permanent override mode).
The sequence is as below:



9

“Reset” if necessary.

B. Start/Reset:

1. After wiring and mounting, switch off all the connected devices. Place 2 new AAA 1.5V alkaline batteries according to the polarities marked.
LCD display will be switched on.
2. Press 'RST' to reset. The thermostat will be ready to control the heater / cooler.
3. Switch ON the heater/cooler and receiver. The heater/cooler will remain OFF until transmitter activates the output ON with  /  displayed on LCD.

C. Normal Time Mode:

1. Temperature detection starts and LCD displays the room temperature.
2. If Battery is LOW,  will be flashing. The old batteries must be replaced with new one immediately.
3. Defrost function is activated with  displayed when temperature is 5°C or below. Output will be forced to ON @ Heat & OFF @ Cool.



6

- Below 0°C, transmitter will display **LO**.
- Above 40°C, transmitter will display **HI**.

D. Normal Time Setting Mode:

- Press $\langle \text{⌚} \rangle$, the Day of Week (1-7) will flash, press $\langle \blacktriangle \rangle$, $\langle \blacktriangledown \rangle$ to select the current Day of Week.
- Press $\langle \text{⌚} \rangle$, the Hour will flash, press $\langle \blacktriangle \rangle$, $\langle \blacktriangledown \rangle$ to set the Hour.
- Press $\langle \text{⌚} \rangle$, the Minute will flash, press $\langle \blacktriangle \rangle$, $\langle \blacktriangledown \rangle$ to set the Minute.
- Press $\langle \text{⌚} \rangle$ will jump back to the step 1.
- Press $\langle \blackleftarrow \rangle$ to confirm the settings and return to Normal Mode.
Or transmitter will auto-return to normal mode after 10 seconds.

E. Factory Defined Programs:

The heater/cooler turns on according to the activated program and the control temperature setting. When the heater/cooler is On. Program number and  

icons are shown. The pre-defined programs are as below:

Heater mode:

	Mon ~ Fri	Sat	Sun
P1	06:00 (21°C)	08:00 (21°C)	08:00 (21°C)
P2	08:00 (16°C)	10:00 (16°C)	10:00 (16°C)
P3	12:00 (21°C)	12:00 (21°C)	12:00 (21°C)
P4	15:00 (16°C)	15:00 (16°C)	15:00 (16°C)
P5	18:00 (21°C)	18:00 (21°C)	18:00 (21°C)
P6	22:00 (16°C)	23:00 (16°C)	23:00 (16°C)

Cooler mode:

	Mon ~ Fri	Sat	Sun
P1	06:00 (24°C)	08:00 (24°C)	08:00 (24°C)
P2	08:00 (29.5°C)	10:00 (29.5°C)	10:00 (29.5°C)
P3	12:00 (24°C)	12:00 (24°C)	12:00 (24°C)
P4	15:00 (29.5°C)	15:00 (29.5°C)	15:00 (29.5°C)
P5	18:00 (24°C)	18:00 (24°C)	18:00 (24°C)
P6	22:00 (26°C)	23:00 (26°C)	23:00 (26°C)