

Datasheet

DIN Circular Connectors

RS Stock number 692-5494



Description:

DIN socket straight version, shielded with metal housing, bend protection and solder terminals.

Specifications:

<u>Temperature range</u>	-20 °C/+85 °C
<u>Materials</u>	
Insulating body	ABS, V0 according to UL 94
Contact spring	CuZn, silvered
Strain relief	steel, nickeled
Screw	steel, nickeled
Housing	CuZn, nickeled
Bend protection	PVC
<u>Mechanical data</u>	
Mating with	DIN plugs 0131, WB
Wire section	≤ AWG 18 (0.75 mm ²)
<u>Electrical data</u>	
Contact resistance contact spring	≤ 30 mΩ
Contact resistance housing	≤ 50 mΩ
Rated current	≤ 4 A
Rated voltage	60 V AC
Test voltage	250 V AC RMS/60 s
Insulation resistance	≥ 100 MΩ

Drawing (mm):

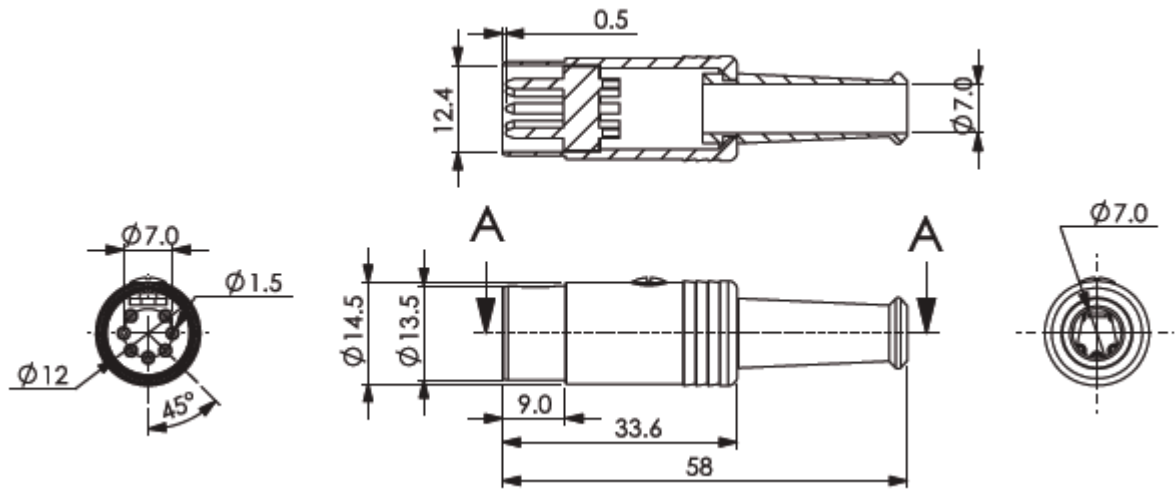

DIN 41524



0131 03

DIN 41524



0131 04

DIN 45322

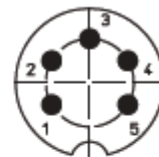

0131 05-1

DIN 45322

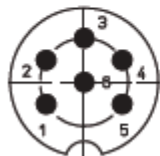

0131 06

DIN 45329

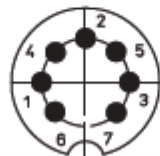

0131 07-1

DIN 45326



0131 08-1