

Click [here](#) for production status of specific part numbers.

MAX38640/1/2/3/A/B

Tiny 1.8V - 5.5V Input, 330nA I_Q, 700mA nanoPower Buck Converter

General Description

The MAX3864xA/B are nanoPower family of ultra-low 330nA quiescent current buck (step-down) DC-DC converters operating from 1.8V to 5.5V input voltage and supporting load currents of up to 175mA, 350mA, 700mA with peak efficiencies of 96%. While in shutdown, there is only 5nA of shutdown current. The devices offer ultra-low quiescent current, small total solution size, and high efficiency throughout the load range. The MAX3864xA/B are ideal for battery applications where long battery life is a must.

The MAX3864xA/B family utilizes a unique control scheme that allows ultra-low quiescent current and high efficiency over a wide output current range. MAX38642 excludes active discharge resistor in shutdown which allows the output to be regulated or held high by another source or by the charged output capacitor.

The MAX3864xA/B devices are offered in a space-saving 1.42mm x 0.89mm 6-pin wafer-level package (WLP) (2 x 3 bumps, 0.4mm pitch), as well as a 2mm x 2mm, 6-pin μ DFN package. All parts are specified from -40°C to +85°C.

Benefits and Features

- Extends Battery Life
 - 330nA Ultra-Low Quiescent Supply Current
 - 5nA Shutdown Current
 - 96% Peak Efficiency and Over 88% at 10 μ A
- Easy to Use – Addresses Popular Operation
 - 1.8V to 5.5V Input Range
 - Preprogrammed V_{OUT} from 0.5V to 5V
 - Single Resistor Adjustable V_{OUT} from 0.7V to 3.3V
 - \pm 1.75% Output Voltage Accuracy
 - Up to 175mA/350mA/700mA Load Current
- Protects System in Multiple Use Cases
 - Reverse-Current Blocking in Shutdown
 - Optional Active Discharge Feature
- Reduces Size and Increases Reliability
 - -40°C to +85°C Temperature Range
 - 2mm x 2mm 6-pin μ DFN Package
 - 1.42mm x 0.89mm, 0.4mm Pitch 6-pin (2 x 3) WLP

Ordering Information appears at end of data sheet.

Applications

- Portable Space-Constrained Consumer Products
- Wearable devices, Ultra-Low-Power IoT, NB IoT, and BLE
- Single Li-ion and Coin Cell Battery Products
- Wired, Wireless, Industrial Products

Typical Operating Circuit

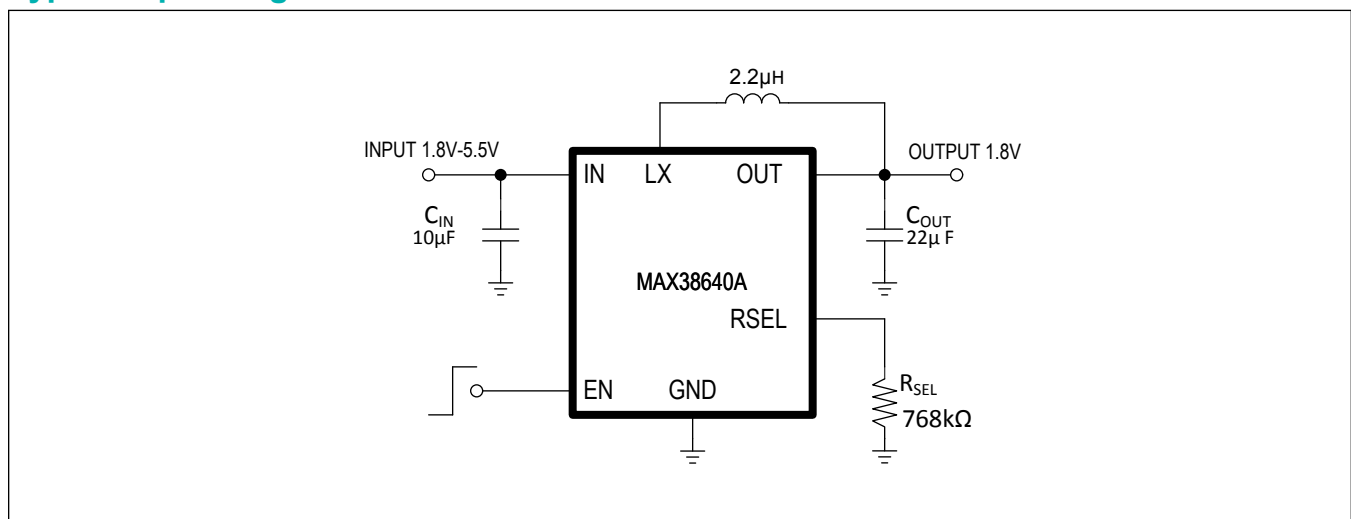

Absolute Maximum Ratings

IN, EN, RSEL, NC, OUT to GND	-0.3V to +6V	4.5mW/°C above +70°C)	357.8mW
LX RMS Current WLP	-1.6A _{RMS} to +1.6A _{RMS}	Operating Temperature Range	-40°C to +85°C
LX RMS Current μDFN	-1A _{RMS} to +1A _{RMS}	Maximum Junction Temperature	+150°C
Continuous Power Dissipation - WLP (T _A = +70°C) (Derate 10.5mW/°C above +70°C)	840mW	Storage Temperature Range	-65°C to +150°C
Continuous Power Dissipation - μDFN (T _A = +70°C) (Derate		Lead Temperature (soldering, 10 seconds)	+300°C
		Soldering Temperature (reflow)	+260°C

Stresses beyond those listed under "Absolute Maximum Ratings" may cause permanent damage to the device. These are stress ratings only, and functional operation of the device at these or any other conditions beyond those indicated in the operational sections of the specifications is not implied. Exposure to absolute maximum rating conditions for extended periods may affect device reliability.

Package Information

6 μDFN

Package Code	L622+1C
Outline Number	21-0164
Land Pattern Number	90-0004
Thermal Resistance, Four Layer Board:	
Junction-to-Ambient (θ _{JA})	223.6°C/W
Junction-to-Case Thermal Resistance (θ _{JC})	122°C/W

For the latest package outline information and land patterns (footprints), go to www.maximintegrated.com/packages. Note that a "+", "#", or "-" in the package code indicates RoHS status only. Package drawings may show a different suffix character, but the drawing pertains to the package regardless of RoHS status.

Package thermal resistances were obtained using the method described in JEDEC specification JESD51-7, using a four-layer board. For detailed information on package thermal considerations, refer to www.maximintegrated.com/thermal-tutorial.

6 WLP

Package Code	N60E1+2
Outline Number	21-100128
Land Pattern Number	Refer to Application Note 1891
Thermal Resistance, Four Layer Board:	
Junction-to-Ambient (θ _{JA})	95.15°C/W

For the latest package outline information and land patterns (footprints), go to www.maximintegrated.com/packages. Note that a "+", "#", or "-" in the package code indicates RoHS status only. Package drawings may show a different suffix character, but the drawing pertains to the package regardless of RoHS status.

Package thermal resistances were obtained using the method described in JEDEC specification JESD51-7, using a four-layer board. For detailed information on package thermal considerations, refer to www.maximintegrated.com/thermal-tutorial.

Electrical Characteristics

(V_{IN} = 3.3V, V_{OUT} = 1.8V, T_A = -40°C to +85°C, C_{IN} = 4.7μF, C_{OUT} = 10μF, unless otherwise specified. (Note 1))

PARAMETER	SYMBOL	CONDITIONS		MIN	TYP	MAX	UNITS
Shutdown Current	I _{IN_SD}	V _{EN} = 0V, T _A = 25°C			0.005	0.1	μA
Input Voltage Range	V _{IN_RANGE}	Guaranteed by Output Accuracy		1.8		5.5	V
Input Undervoltage Lockout	V _{UVLO}	R _{SEL} > 50kΩ (MAX3864xA), MAX3864xB	V _{IN} rising		1.75	1.8	V
			Hysteresis		50		mV
	V _{UVLO}	R _{SEL} < 50kΩ (MAX3864xA)	V _{IN} rising		2.6	2.7	V
			Hysteresis		125		mV
Output Voltage Range	V _{OUT_RANGE}	Guaranteed by Output Accuracy		0.5		5	V
Output Accuracy	V _{OUT_ACC}	OUT falling, when LX begins switching above 1MHz, V _{OUT} = 0.7V to 3.3V, V _{IN} = 5.5V (Note 2)		-1.75		+1.75	%
DC Line Regulation	V _{LREG}	V _{OUT} = 1.8V, V _{IN} = 2.0V to 5.5V, I _{OUT} = 10mA to 160mA			±1.5		%
Quiescent Supply Current Into IN	I _{Q_IN}	V _{EN} = V _{IN} , not switching V _{OUT} = 106% of target voltage, V _{OUT TARGET} = 2.5V, T _A = 25°C			330	660	nA
Quiescent Supply Current Into OUT	I _{Q_OUT}	V _{EN} = V _{IN} , not switching V _{OUT} = 106% of target voltage, V _{OUT TARGET} = 2.5V, T _A = 25°C			10		nA
Soft-Start Slew Rate	dV _{OUT} /dt	V _{OUT} = 1.8V, no load			6.5		mV/μs
LX Leakage Current	I _{LEAK_LX}	V _{LX} = V _{IN} = 5.5V, T _A = 25°C			2	100	nA
Inductor Peak Current Limit	I _{PEAK_LX}	MAX38643		800	1000	1200	mA
		MAX38641/MAX38642		400	500	600	
		MAX38640		225	250	300	
High-Side R _{DS(on)}	R _{DS_H}	V _{IN} = 3.3V	MAX38643		95	150	mΩ
			MAX38641/ MAX38642		170	320	
			MAX38640		320	600	
Low-Side R _{DS(on)}	R _{DS_L}	V _{IN} = 3.3V	MAX38643		50	90	mΩ
			MAX38641/ MAX38642		80	160	
			MAX38640		150	290	
Zero-Crossing Threshold	I _{ZX_LX}	V _{OUT} = 1.2V, percent of I _{PEAK_LX}			5		%
Enable Input Leakage	I _{LEAK_EN}	V _{EN} = 5.5V, T _A = +25°C			0.1	100	nA
Enable Voltage Threshold	V _{EN_R}	V _{EN} rising			0.8	1.2	V
	V _{EN_F}	V _{EN} falling		0.4	0.7		
Active Discharge Resistance (MAX3860/ MAX3861/MAX3863 Only)	R _{OUT_DIS}	V _{EN} = 0V,		50	85	200	Ω

Electrical Characteristics (continued)(V_{IN} = 3.3V, V_{OUT} = 1.8V, T_A = -40°C to +85°C, C_{IN} = 4.7μF, C_{OUT} = 10μF, unless otherwise specified. (Note 1))

PARAMETER	SYMBOL	CONDITIONS	MIN	TYP	MAX	UNITS
Required Select Resistor Accuracy (MAX3864xA only)	R _{SEL}	Use the nearest ±1% resistor from R _{SEL} Selection Table	-1		+1	%
Select Resistor Detection Time (MAX3864xA Only)	t _{RSEL}	C _{SEL} < 2pF	240	600	1320	μs
Thermal Shutdown	T _{SHUT}	T _J rising when output turns off		165		°C
Thermal Shutdown Threshold	T _{SHUT}	T _J falling when output turns on		150		°C

Note 1: Limits over the specified operating temperature and supply voltage range are guaranteed by design and characterization, and production tested at room temperature only.

Note 2: Output Accuracy in Low Power Mode (LPM) and does not include load, line or ripple.

Typical Operating Characteristics

(MAX38640AENT+, V_{IN} = 3.6V, V_{OUT} = 1.8V, L = 2.2μH, C_{IN} = 10μF, C_{OUT} = 22μF, T_A = 25°C, unless otherwise noted.)

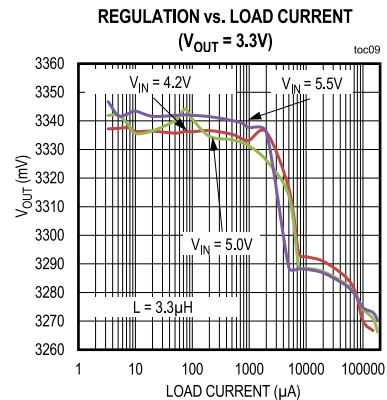
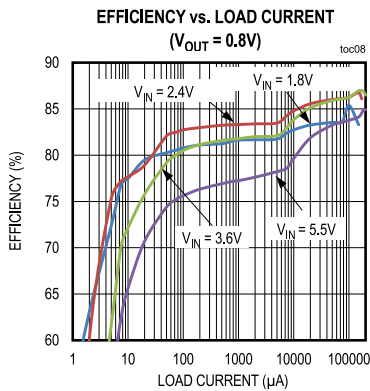
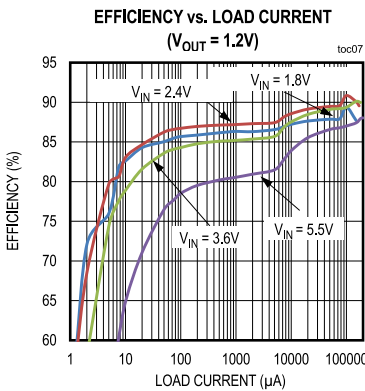
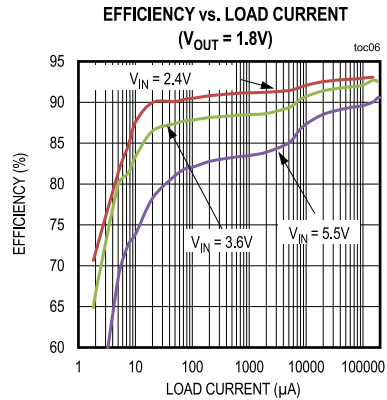
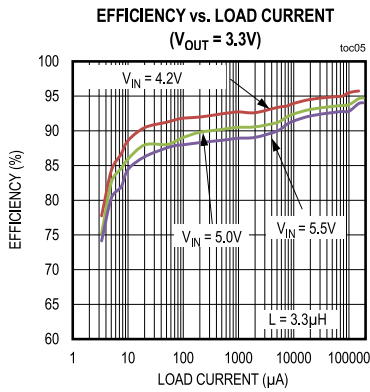
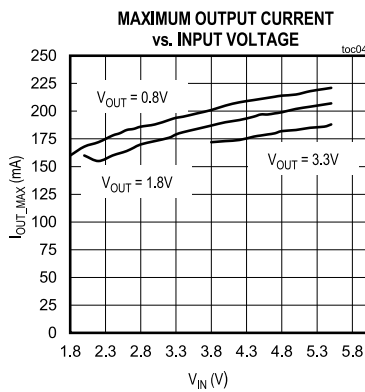
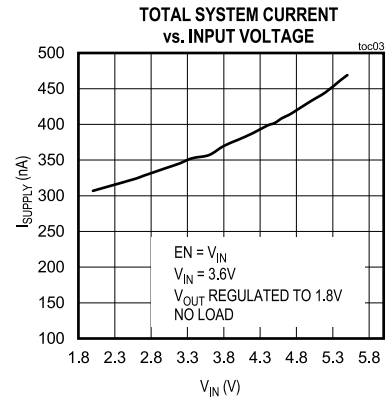
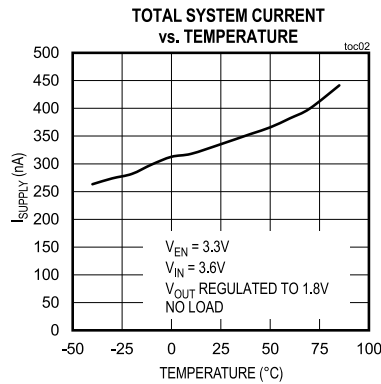
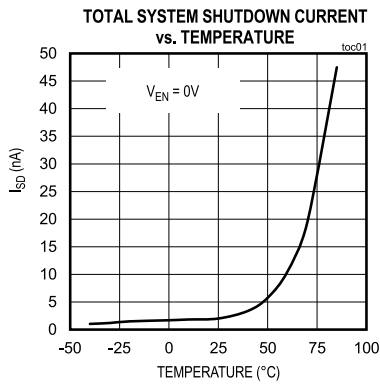

Typical Operating Characteristics (continued)

(MAX38640AENT+, V_{IN} = 3.6V, V_{OUT} = 1.8V, L = 2.2μH, C_{IN} = 10μF, C_{OUT} = 22μF, T_A = 25°C, unless otherwise noted.)

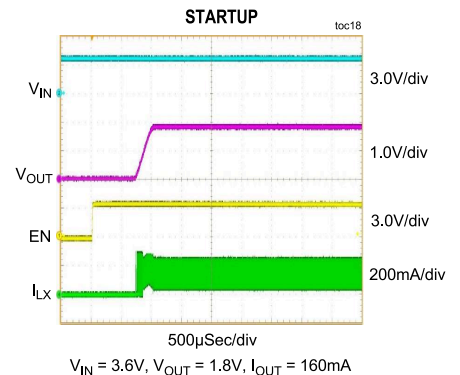
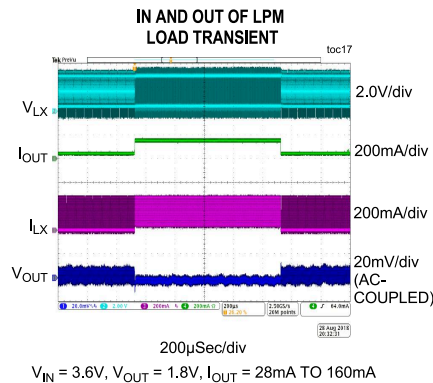
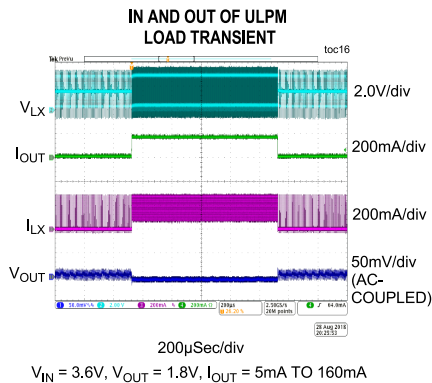
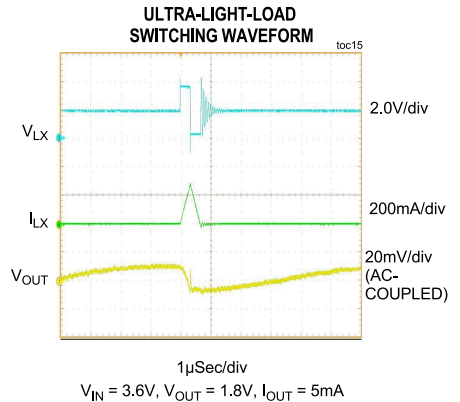
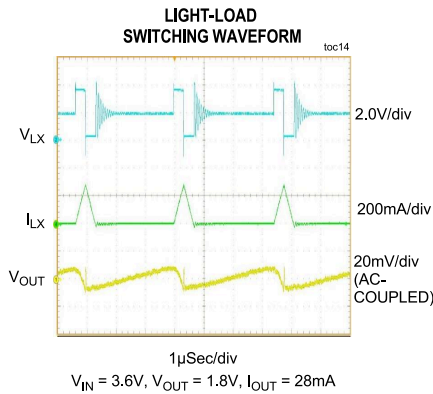
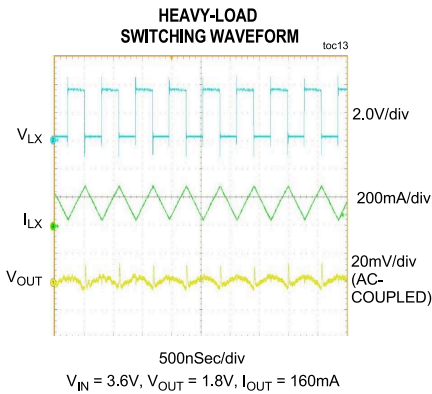
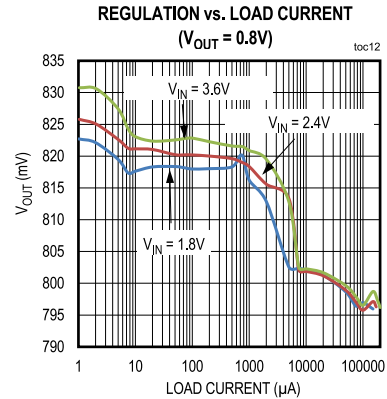
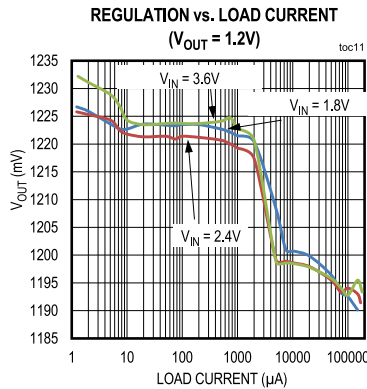
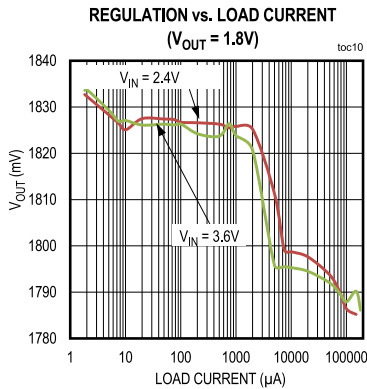

Typical Operating Characteristics (continued)

(MAX38640AENT+, V_{IN} = 3.6V, V_{OUT} = 1.8V, L = 2.2μH, C_{IN} = 10μF, C_{OUT} = 22μF, T_A = 25°C, unless otherwise noted.)

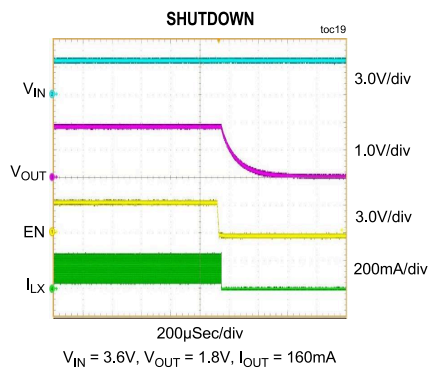

Pin Configurations

MAX3864__ELT+

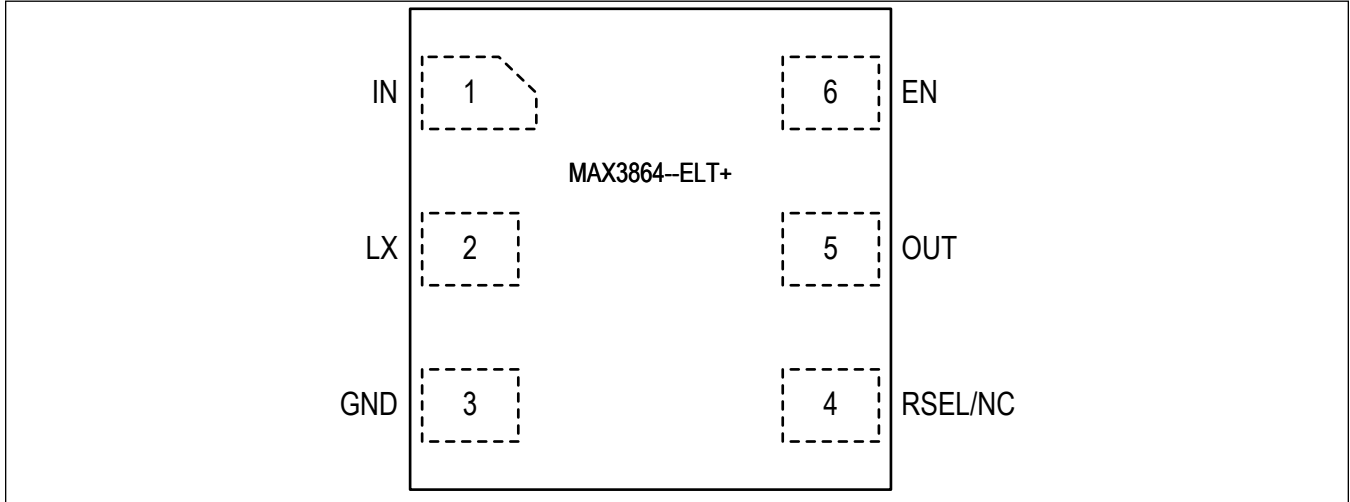

MAX3864__ENT+

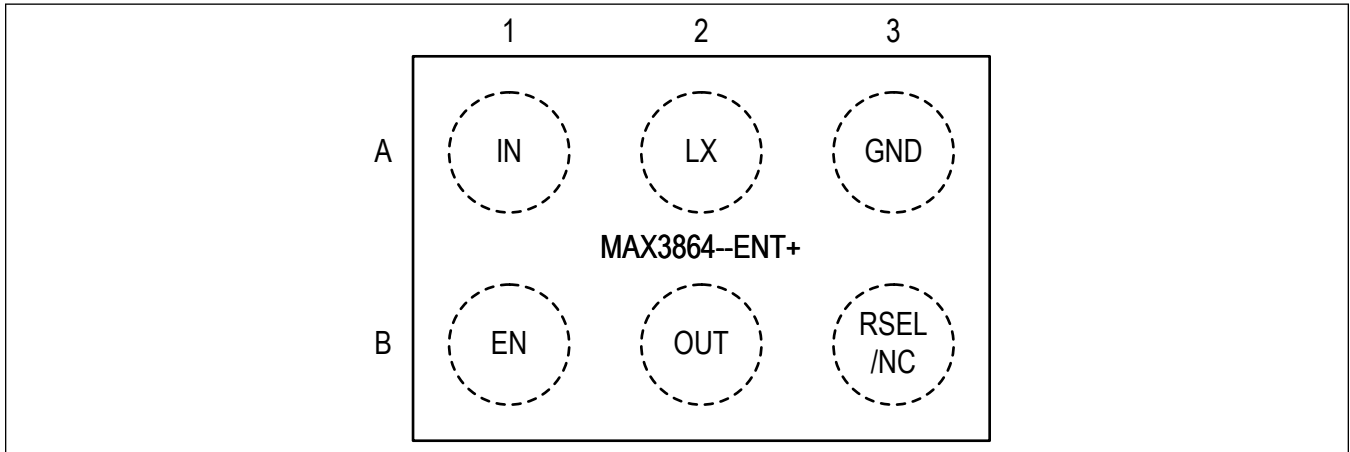

Pin Description

PIN		NAME	FUNCTION
MAX3864__ELT+	MAX3864__ENT+		
1	A1	IN	Regulator Supply Input. Connect to a voltage between 1.8V and 5.5V and bypass with a 10µF capacitor from IN to GND.
2	A2	LX	Switching Node. Connect an inductor between LX and the regulator output.
3	A3	GND	Ground.

Pin Description (continued)

PIN		NAME	FUNCTION
MAX3864 __ELT+	MAX3864 __ENT+		
4	B3	RSEL/NC	<p>MAX3864 __A: Output Voltage Select Input. Connect a resistor from RSEL to GND to program the output voltage and IN undervoltage threshold based on the Table 1.</p> <p>MAX3864 __B: No Connect. Leave floating.</p>
5	B2	OUT	Output Voltage Sense Input. Connect to the load at a point where accurate regulation (output capacitor) is required to eliminate resistive metal drops.
6	B1	EN	Enable Input. Force this pin high to enable the buck converter. Force this pin low to disable the part and enter shutdown.

Functional Diagrams

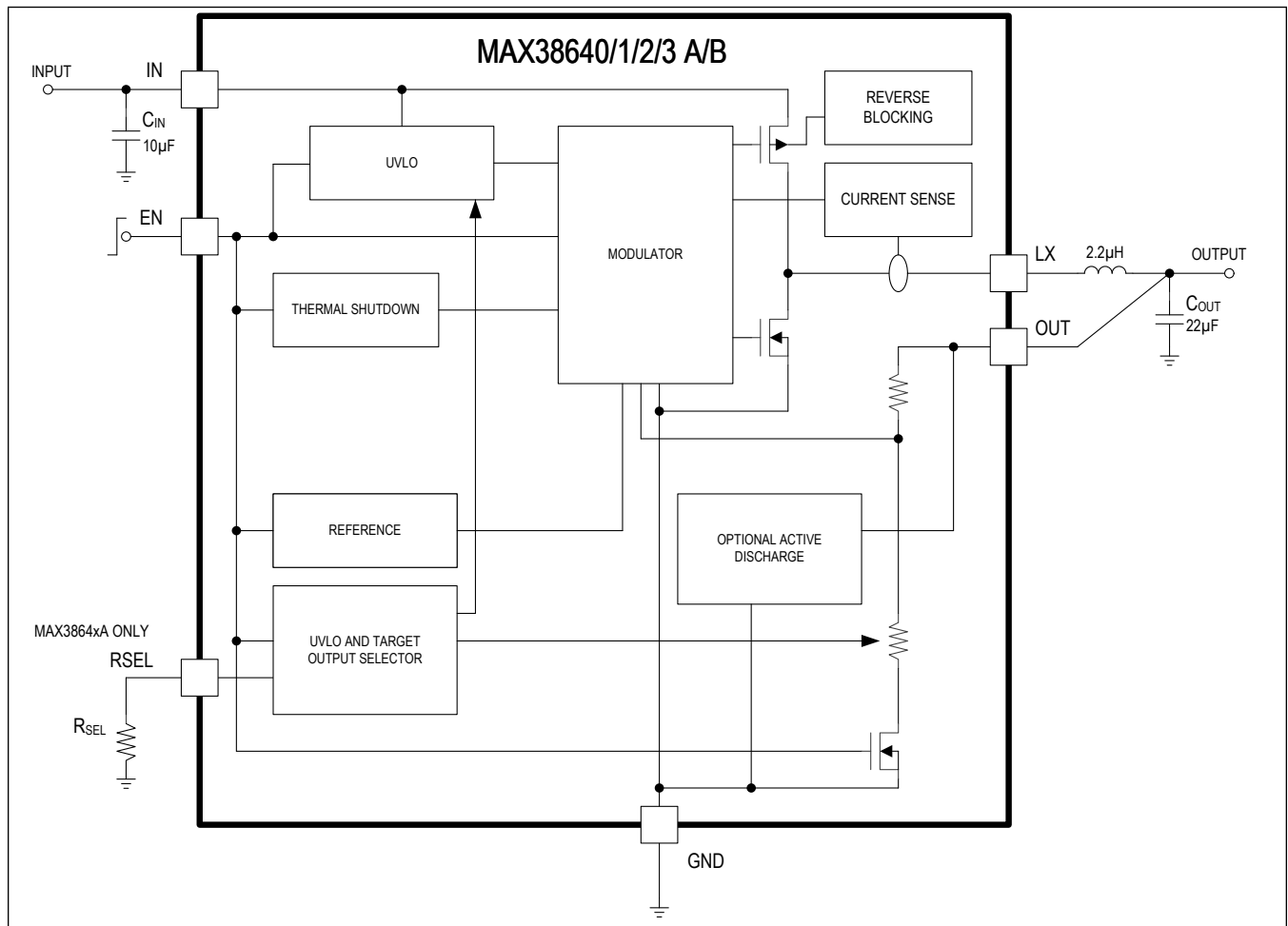

Detailed Description

MAX38640/1/2/3 A/B are ultra-low IQ (330nA) buck converters that step-down from 1.8V to 5.5V to wide range of output voltages between 0.5V to 5V. The output voltage is either programmable on MAX3864xA versions using an external resistor or fixed for MAX3864xB versions. The external R_{SEL} resistor on the RSEL pin programs the output voltage upon startup for MAX3864xA versions.

The buck converter automatically switches between ultra-low-power mode (ULPM), low-power mode (LPM), and high-power mode (HPM) to better service the load, depending on the load current. The buck converter overregulates in ultra-low-power mode to allow the output capacitor to handle the transient load currents. The device has 90% duty cycle limitation.

Active discharge resistor in MAX38640/MAX38641/MAX38643 pulls OUT to ground when the part is in shutdown. Active discharge has been strategically omitted for MAX38642 to preserve the charge on the output capacitor in shutdown. Harvesting applications where the output is connected to a super capacitor can take advantage of reverse-current blocking feature to preserve the charge on the output capacitor even if the input were to fall below the output in shutdown. Applications where two MAX38642 buck converters are connected in parallel to drive the load can have the input of one of the buck converters to go to 0V in shutdown without dragging the output down or loading the other buck.

Voltage Configuration

The MAX3864xA includes an RSEL pin to configure the output voltage and input UVLO threshold on startup. Resistors with tolerance 1% (or better) should be chosen, with nominal values specified in [Table 1](#).

Table 1. MAX3864xA RSEL Selection Table

TARGET OUTPUT VOLTAGE (V)	RSEL (kΩ)	INPUT UVLO THRESHOLD, RISING (V)
2.5	OPEN	1.75
2	909	1.75
1.8	768	1.75
1.5	634	1.75
1.3	536	1.75
1.25	452	1.75
1.2	383	1.75
1.15	324	1.75
1.1	267	1.75
1.05	226	1.75
1	191	1.75
0.95	162	1.75
0.9	133	1.75
0.85	113	1.75
0.8	95.3	1.75
0.75	80.6	1.75
0.7	66.5	1.75
3.3	56.2	2.6
3	47.5	2.6
2.8	40.2	2.6
2.75	34	2.6
2.5	28	2.6
2	23.7	2.6
1.8	20	2.6
1.5	16.9	2.6
1.25	14	2.6
1.2	11.8	2.6
1.15	10	2.6
1.1	8.45	2.6
1	7.15	2.6
0.95	5.9	2.6

Table 1. MAX3864xA RSEL Selection Table (continued)

TARGET OUTPUT VOLTAGE (V)	R _{SEL} (kΩ)	INPUT UVLO THRESHOLD, RISING (V)
0.9	4.99	2.6
0.8	SHORT TO GND	2.6

The MAX3864xB has a fixed output voltage that is preprogrammed (no RSEL programming). Contact Maxim to order a part with an output voltage listed in [Table 2](#). The input UVLO threshold for MAX3864xB is 1.75V (typ., V_{IN} rising) with 50mV hysteresis (typ.).

Table 2. MAX3864xB Preprogrammed Output Voltage Table

PART NUMBER	OUTPUT VOLTAGE (V)
MAX3864xB-50	5.0
MAX3864xB-45	4.5
MAX3864xB-40	4.0
MAX3864xB-33	3.3
MAX3864xB-30	3.0
MAX3864xB-275	2.75
MAX3864xB-25	2.5
MAX3864xB-20	2.0
MAX3864xB-18	1.8
MAX3864xB-15	1.5
MAX3864xB-12	1.2
MAX3864xB-10	1.0
MAX3864xB-09	0.9
MAX3864xB-08	0.8
MAX3864xB-07	0.7
MAX3864xB-065	0.65
MAX3864xB-06	0.6
MAX3864xB-055	0.55
MAX3864xB-05	0.5

Applications Information

Inductor Selection

The inductor value for MAX3864x affects the ripple current, the transition point from low power mode (LPM) to ultra-low-power mode (ULPM), and the overall efficiency performance. Based on the peak current limit required for different applications, it is recommended to select an inductor value based on [Table 3](#).

Table 3. Inductor Selection

PEAK CURRENT, PART NUMBER	INDUCTANCE RANGE (μH)
1.0A Peak Current, MAX38643	1.0–1.5
500mA Peak Current, MAX38641/MAX38642	2.2
250mA Peak Current, MAX38640	2.2–4.7

Input Capacitor

The input capacitor (C_{IN}) reduces the peak current drawn from battery or input power source and reduces the switching noise in the IC. The impedance of C_{IN} at the switching frequency should be very low. Ceramic capacitors are recommended with their small size and low ESR. For most applications, use 10 μF ceramic capacitor with X5R or X7R temperature characteristics.

Output Capacitor

The output capacitor (C_{OUT}) is required to keep the output voltage ripple small and to ensure loop stability. C_{OUT} must have low impedance at the switching frequency. Ceramic capacitors are recommended due to their small size and low ESR. Make sure the capacitor does not degrade its capacitance significantly over temperature and DC bias. Capacitors with X5R or X7R temperature characteristics typically perform well. A 22 μF ceramic capacitor is recommended for most applications.

Enabling Device

The device has a dedicated EN pin. This pin can be driven by a digital signal. It is recommended that the digital signal enables the device after V_{IN} crosses the UVLO threshold. In applications where EN is tied to IN, the device is designed to be powered by fast V_{IN} slew rates. If V_{IN} slew rates are slower than 5V/ms, users must delay enabling the device after V_{IN} crosses the UVLO threshold. This can be done using a simple RC circuit, as shown in [Figure 1](#).

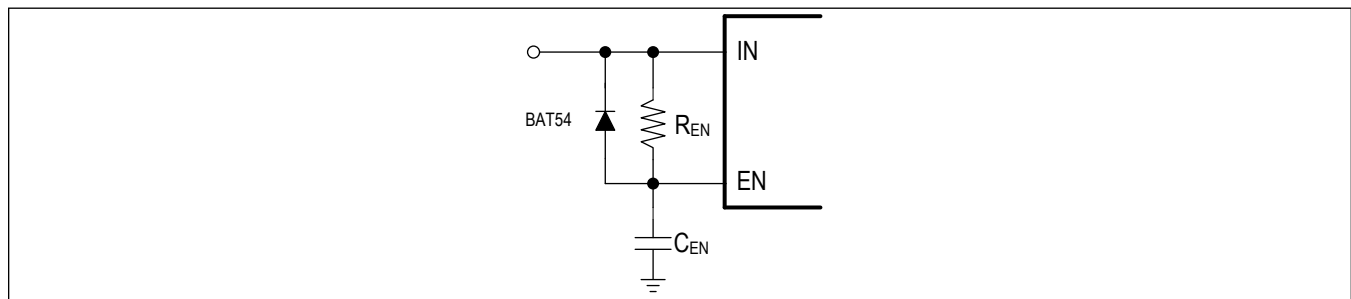

Figure 1. RC Circuit at EN

PCB Layout and Routing

High switching frequencies and large peak currents make PCB layout a very important part of the buck regulator design. Good design minimizes excessive EMI (Electromagnetic Interference) on the feedback paths and voltage gradients in the ground plane, to avoid instability and regulation errors. The input capacitor (C_{IN}) should be placed as close as possible to the IC pins IN and GND. Connect the inductor, input capacitor, and output capacitor (C_{OUT}) as close together as possible, and keep their traces short, direct, and wide.

Connect the two GND pins under the IC and directly to the ground of the output capacitor. Keep noisy traces, such as the LX node, as short as possible. The OUT pin should be connected to the output capacitor and this trace should be routed away from the main power path between the inductor and C_{OUT}. The OUT trace should also be routed away from noisy traces such as the LX line or other external noise sources. Refer to the MAX3864x evaluation kit for an example PCB layout and routing scheme.

Ordering Information

PART NUMBER	PEAK INDUCTOR CURRENT (A)	ACTIVE DISCHARGE	FEATURES	PACKAGE
MAX38640AELT+*	0.25	Yes	0.7V to 3.3V Resistor-Selectable Output Voltage Using RSEL (Resistor Select) Pin	6-pin 2mm x 2mm μ DFN
MAX38641AELT+*	0.50	Yes		
MAX38642AELT+*	0.50	—		
MAX38643AELT+*	1.00	Yes		
MAX38640BELT+*	0.25	Yes	0.5V to 5V Preprogrammed Output Voltage	
MAX38641BELT+*	0.50	Yes		
MAX38642BELT+*	0.50	—		
MAX38643BELT+*	1.00	Yes		
MAX38640AENT+	0.25	Yes	0.7V to 3.3V Resistor-Selectable Output Voltage Using RSEL (Resistor Select) Pin	6-pin 2mm x 3 0.4mm Pitch WLP
MAX38641AENT+*	0.50	Yes		
MAX38642AENT+*	0.50	—		
MAX38643AENT+*	1.00	Yes		
MAX38640BENT+*	0.25	Yes	0.5V to 5V Preprogrammed Output Voltage	
MAX38641BENT+*	0.50	Yes		
MAX38642BENT+*	0.50	—		
MAX38643BENT+*	1.00	Yes		

*Future product—contact factory for availability.

+Denotes a lead(Pb)-free/RoHS-compliant package.

T Denotes tape-and-reel.

Revision History

REVISION NUMBER	REVISION DATE	DESCRIPTION	PAGES CHANGED
0	10/18	Initial release	—

For pricing, delivery, and ordering information, please visit Maxim Integrated's online storefront at <https://www.maximintegrated.com/en/storefront/storefront.html>.

Maxim Integrated cannot assume responsibility for use of any circuitry other than circuitry entirely embodied in a Maxim Integrated product. No circuit patent licenses are implied. Maxim Integrated reserves the right to change the circuitry and specifications without notice at any time. The parametric values (min and max limits) shown in the Electrical Characteristics table are guaranteed. Other parametric values quoted in this data sheet are provided for guidance.