



### Main

Range of product	Modicon M251
Product or component type	Logic controller
[Us] rated supply voltage	24 V DC

### Complementary

Maximum number of I/O expansion module	7 (local I/O-Architecture) 14 (remote I/O-Architecture)
Supply voltage limits	20.4...28.8 V
Inrush current	50 A
Power consumption in W	32.6...40.4 W (with max number of I/O expansion module)
Memory capacity	64 MB for system memory RAM
Data backed up	128 MB built-in flash memory for backup of user programs
Data storage equipment	<= 16 GB SD card (optional)
Battery type	BR2032 lithium non-rechargeable, battery life: 4 year(s)
Backup time	2 years at 25 °C
Execution time for 1 KInstruction	0.3 Ms for event and periodic task 0.7 ms for other instruction
Application structure	3 cyclic master tasks + 1 freewheeling task 8 event tasks 4 cyclic master tasks 8 external event tasks
Realtime clock	With
Clock drift	<= 60 s/month at 25 °C
Integrated connection type	USB port with mini B USB 2.0 connector Non isolated serial link serial with RJ45 connector and RS232/RS485 interface Dual-port Ethernet with RJ45 connector CANopen J1939 with SUB-D 9 connector
Supply	(serial)serial link supply: 5 V, <200 mA
Transmission rate	1.2...115.2 kbit/s (115.2 kbit/s by default) for bus length of 15 m for RS485 1.2...115.2 kbit/s (115.2 kbit/s by default) for bus length of 3 m for RS232 480 Mbit/s for bus length of 3 m for USB
Communication port protocol	USB port: USB - SoMachine-Network Non isolated serial link: Modbus master/slave - RTU/ASCII or SoMachine-Network
Port Ethernet	Ethernet marking 10BASE-T/100BASE-TX - 2 copper cable
Web services	Web server

The information provided in this documentation contains general descriptions and/or technical characteristics of the performance of the products contained herein. This documentation is not intended as a substitute for and is not to be used for determining suitability or reliability of these products for specific user applications. It is the duty of any such user or integrator to perform the appropriate and complete risk analysis, evaluation and testing of the products with respect to the relevant specific application or use thereof. Neither Schneider Electric Industries SAS nor any of its affiliates or subsidiaries shall be responsible or liable for misuse of the information contained herein.

Communication service	DHCP client Downloading Ethernet/IP slave device IEC VAR ACCESS Modbus TCP client Modbus TCP server Modbus TCP slave device Monitoring NGVL Programming Updating firmware SMS notifications FTP client/server SNMP client/server SQL client Send and receive email from the controller based on TCP/UDP library Web server (WebVisu & XWeb system) OPC UA server DNS client
Maximum number of connections	8 Modbus server 8 Modbus client 16 Ethernet/IP target 4 FTP server 10 web server 8 SoMachine protocol
CANopen feature profile	DR 303-1 DS 301 V4.02
Number of server device(s)	63 CANopen:
Local signalling	1 LED (green) for PWR 1 LED (green) for RUN 1 LED (red) for module error (ERR) 1 LED (red) for I/O error (I/O) 1 LED (green) for SD card access (SD) 1 LED (red) for BAT 1 LED (green) for Ethernet port activity 1 LED (green) for SL 1 LED (red) for bus fault on TM4 (TM4) 1 LED (green) for CANopen run 1 LED (green) for CANopen error
Electrical connection	Removable screw terminal blockpower supply (pitch 5.08 mm)
Insulation	Non-insulated between supply and internal logic Between supply and ground at 500 V AC
Marking	CE
Surge withstand	1 kV shielded cable common mode conforming to IEC 61000-4-5 1 kV power lines common mode conforming to IEC 61000-4-5 0.5 kV power lines differential mode conforming to IEC 61000-4-5
Mounting support	Top hat type TH35-15 rail conforming to IEC 60715 Top hat type TH35-7.5 rail conforming to IEC 60715 Plate or panel with fixing kit
Height	90 mm
Depth	95 mm
Width	54 mm
Net weight	0.22 kg

## Environment

Standards	ANSI/ISA 12-12-01 CSA C22.2 No 142 CSA C22.2 No 213 IEC 61131-2:2007 Marine specification (LR, ABS, DNV, GL) UL 508
Product certifications	cULus[RETURN]CE[RETURN]UKCA[RETURN]DNV-GL[RETURN]ABS[RETURN]LR
Resistance to electrostatic discharge	8 kV in air conforming to IEC 61000-4-2 4 kV on contact conforming to IEC 61000-4-2
Resistance to electromagnetic fields	10 V/M 80 MHz...1 GHz conforming to IEC 61000-4-3 3 V/M 1.4 GHz...2 GHz conforming to IEC 61000-4-3 1 V/m 2 GHz...3 GHz conforming to IEC 61000-4-3
Resistance to fast transients	2 kV (power lines) conforming to IEC 61000-4-4 1 kV (Ethernet line) conforming to IEC 61000-4-4 1 kV (serial link) conforming to IEC 61000-4-4

Resistance to conducted disturbances	10 V 0.15...80 MHz conforming to IEC 61000-4-6 3 V 0.1...80 MHz conforming to Marine specification (LR, ABS, DNV, GL) 10 V spot frequency (2, 3, 4, 6.2, 8.2, 12.6, 16.5, 18.8, 22, 25 MHz) conforming to Marine specification (LR, ABS, DNV, GL)
Electromagnetic emission	Conducted emissions - test level: 120...69 dB $\mu$ V/m QP ( power lines) at 10...150 kHz conforming to IEC 55011 Conducted emissions - test level: 63 dB $\mu$ V/m QP ( power lines) at 1.5...30 MHz conforming to IEC 55011 Radiated emissions - test level: 40 dB $\mu$ V/m QP class A ( 10 m) at 30...230 MHz conforming to IEC 55011 Conducted emissions - test level: 79...63 dB $\mu$ V/m QP ( power lines) at 150...1500 kHz conforming to IEC 55011 Radiated emissions - test level: 47 dB $\mu$ V/m QP class A ( 10 m) at 230...1000 MHz conforming to IEC 55011
Immunity to microbreaks	10 ms
Ambient air temperature for operation	-10...35 °C (vertical installation) -10...55 °C (horizontal installation)
Ambient air temperature for storage	-25...70 °C
Relative humidity	10...95 %, without condensation (in operation) 10...95 %, without condensation (in storage)
IP degree of protection	IP20 with protective cover in place
Pollution degree	2
Operating altitude	0...2000 m
Storage altitude	0...3000 m
Vibration resistance	3.5 mm at 5...8.4 Hz on symmetrical rail 3 gn at 8.4...150 Hz on symmetrical rail 3.5 mm at 5...8.4 Hz on panel mounting 3 gn at 8.4...150 Hz on panel mounting
Shock resistance	15 gn for 11 ms

## Packing Units

Unit Type of Package 1	PCE
Number of Units in Package 1	1
Package 1 Height	10.632 cm
Package 1 Width	11.868 cm
Package 1 Length	16.721 cm
Package 1 Weight	380.0 g
Unit Type of Package 2	S03
Number of Units in Package 2	10
Package 2 Height	30 cm
Package 2 Width	30 cm
Package 2 Length	40 cm
Package 2 Weight	4.461 kg
Unit Type of Package 3	P06
Number of Units in Package 3	80
Package 3 Height	75.0 cm
Package 3 Width	40.0 cm
Package 3 Length	80.0 cm
Package 3 Weight	43 kg

## Offer Sustainability

Sustainable offer status	Green Premium product
REACH Regulation	<a href="#">REACH Declaration</a>
EU RoHS Directive	Pro-active compliance (Product out of EU RoHS legal scope)
Mercury free	Yes
China RoHS Regulation	<a href="#">China RoHS Declaration</a>
RoHS exemption information	<a href="#">Yes</a>
Environmental Disclosure	<a href="#">Product Environmental Profile</a>
Circularity Profile	<a href="#">End Of Life Information</a>

---

WEEE	The product must be disposed on European Union markets following specific waste collection and never end up in rubbish bins
PVC free	Yes

---

Dimensions

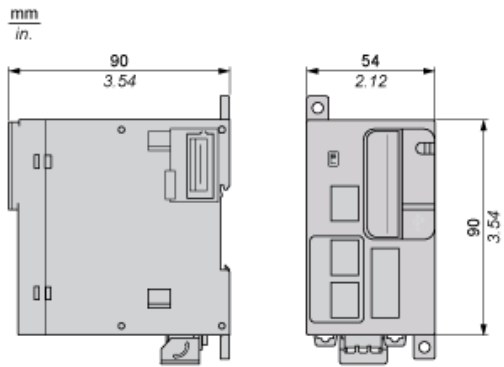

Clearance

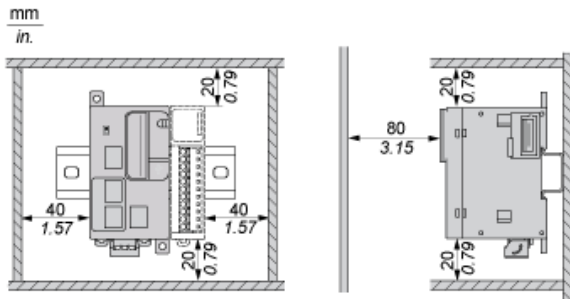

Mounting Position

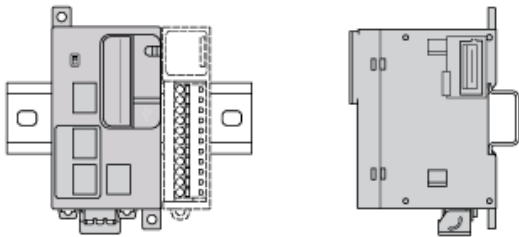

NOTE: Keep adequate spacing for proper ventilation and to maintain an ambient temperature between -10°C (14°F) and 55°C (131°F).

Acceptable Mounting

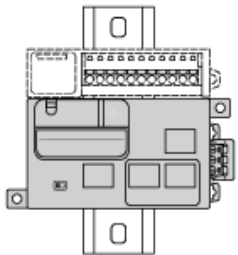

NOTE: Expansion modules must be mounted above the controller.

Incorrect Mounting

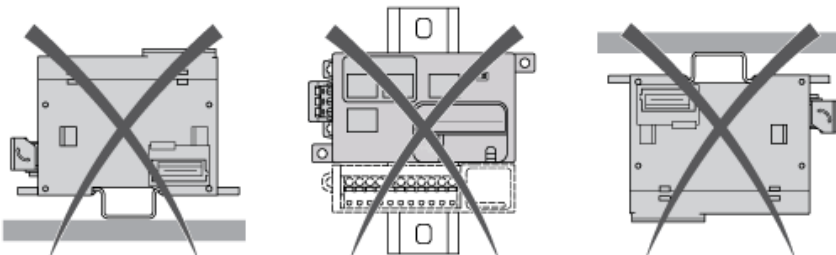

Direct Mounting on a Panel Surface

M4 x 6/8 mm  
0.24/0.31 in.

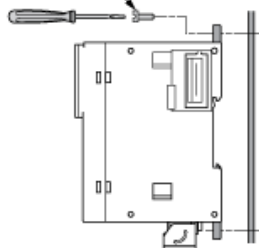

mm  
in.

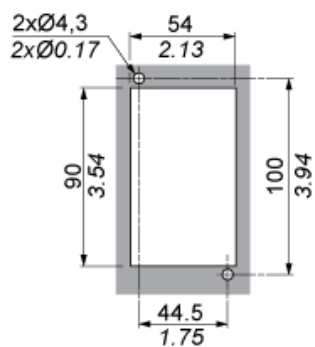

USB Connection to a PC



Ethernet Connection to a PC



CANopen

Wiring

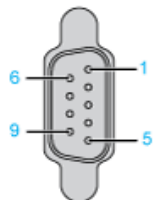

Pin	Signal	Description
1	–	Reserved
2	CAN_L	CAN_L bus line
3	CAN_GND	CAN ground
4	–	Reserved
5	(CAN_SHLD)	Optional CAN shield
6	GND	Ground
7	CAN_H	CAN_H bus line
8	–	Reserved
9	(CAN_V+)	Optional CAN external positive supply