



### Typical Applications

The HMC734LP5(E) is ideal for:

- Point-to-Point/Multi-Point Radio
- Test Equipment & Industrial Controls
- SATCOM
- Military End-Use

### Features

- Dual Output:  $F_o = 8.6 - 10.2 \text{ GHz}$   
 $F_o/4 = 2.15 - 2.55 \text{ GHz}$
- Pout: +18 dBm
- Phase Noise: -100 dBc/Hz @ 100 kHz Typ.
- No External Resonator Needed
- 32 Lead 5x5mm SMT Package: 25mm<sup>2</sup>

### Functional Diagram

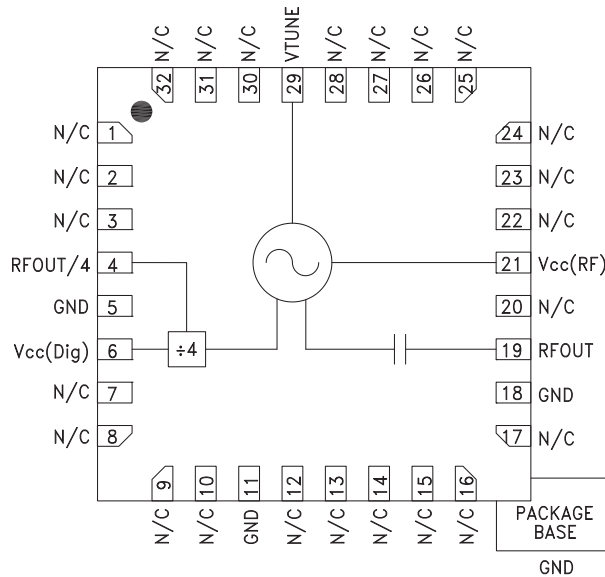

### General Description

The HMC734LP5(E) is a GaAs InGaP Heterojunction Bipolar Transistor (HBT) MMIC VCO. The HMC734LP5(E) integrates a resonator, negative resistance device, varactor diode and features a divide-by-4 frequency output. The VCO's phase noise performance is excellent over temperature, shock, and process due to the oscillator's monolithic structure. Power output is +18 dBm typical from a +5V supply voltage. The prescaler function can be disabled to conserve current if not required. The voltage controlled oscillator is packaged in a leadless QFN 5x5 mm surface mount package, and requires no external matching components.

### Electrical Specifications, $T_A = +25^\circ \text{C}$ , $V_{cc}(\text{Dig})$ , $V_{cc}(\text{Amp})$ , $V_{cc}(\text{RF}) = +5\text{V}$

Parameter	Min.	Typ.	Max.	Units	
Frequency Range	$F_o$ $F_o/4$	8.6 - 10.2 2.15 - 2.55		GHz GHz	
Power Output	RFOUT RFOUT/4	15 -8	22 -1	dBm dBm	
SSB Phase Noise @ 100 kHz Offset, $V_{tune} = +5\text{V}$ @ RFOUT		-100		dBc/Hz	
Tune Voltage	$V_{tune}$	1	13	V	
Supply Current	$I_{cc}(\text{Dig}) + I_{cc}(\text{Amp}) + I_{cc}(\text{RF})$	180	218	240	mA
Tune Port Leakage Current ( $V_{tune} = 13\text{V}$ )			10	$\mu\text{A}$	
Output Return Loss (RFOUT)		8		dB	
Harmonics/Subharmonics	1/2 2nd 3rd	66 15 30		dBc dBc	
Pulling (into a 2.0:1 VSWR)		38		MHz pp	
Pushing @ $V_{tune} = 5\text{V}$		30		MHz/V	
Frequency Drift Rate		1.1		MHz/ $^\circ\text{C}$	

Information furnished by Analog Devices is believed to be accurate and reliable. However, no responsibility is assumed by Analog Devices for its use, nor for any infringements of patents or other rights of third parties that may result from its use. Specifications subject to change without notice. No license is granted by implication or otherwise under any patent or patent rights of Analog Devices. Trademarks and registered trademarks are the property of their respective owners.

For price, delivery, and to place orders: Analog Devices, Inc., One Technology Way, P.O. Box 9106, Norwood, MA 02062-9106 Phone: 781-329-4700 • Order online at [www.analog.com](http://www.analog.com) Application Support: Phone: 1-800-ANALOG-D

# HMC734\* PRODUCT PAGE QUICK LINKS

Last Content Update: 02/23/2017

---

## COMPARABLE PARTS

View a parametric search of comparable parts.

## EVALUATION KITS

- HMC734LP5 Evaluation Board

## DOCUMENTATION

### Data Sheet

- HMC734 Data Sheet

## REFERENCE MATERIALS

### Quality Documentation

- Package/Assembly Qualification Test Report: 32L 5x5mm QFN Package (QTR: 10009 REV: 05)
- Package/Assembly Qualification Test Report: LP3, LP4, LP5 & LP5G (QTR: 2014-00145)
- Semiconductor Qualification Test Report: GaAs HBT-A (QTR: 2013-00228)

## DESIGN RESOURCES

- HMC734 Material Declaration
- PCN-PDN Information
- Quality And Reliability
- Symbols and Footprints

## DISCUSSIONS

View all HMC734 EngineerZone Discussions.

## SAMPLE AND BUY

Visit the product page to see pricing options.

## TECHNICAL SUPPORT

Submit a technical question or find your regional support number.

## DOCUMENT FEEDBACK

Submit feedback for this data sheet.

---



**MMIC VCO w/ DIVIDE-BY-4  
8.6 - 10.2 GHz**

**Frequency vs. Tuning Voltage, Vcc = +5V**

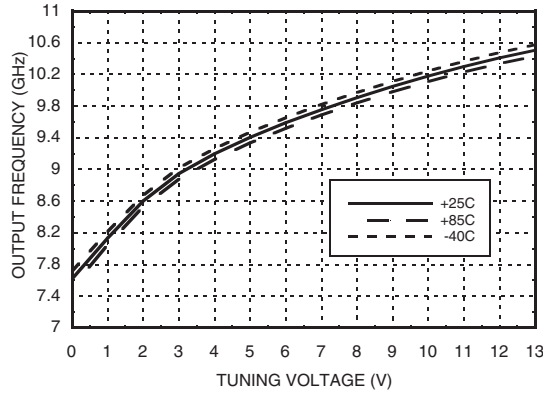

**Frequency vs. Tuning Voltage, T = 25°C**

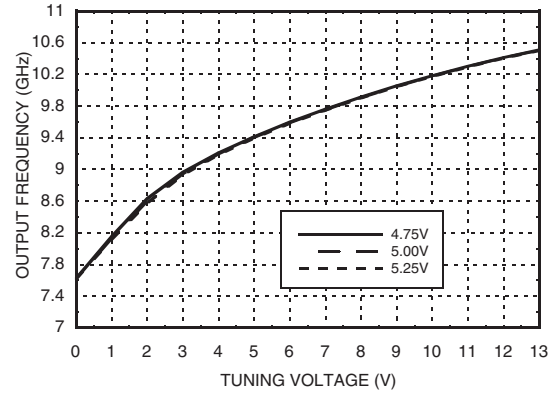

**Sensitivity vs. Tuning Voltage, Vcc = +5V**

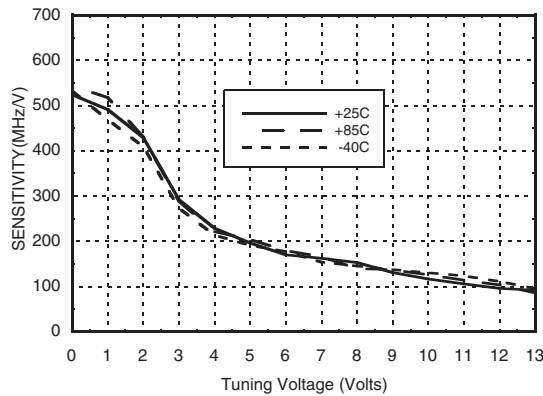

**Output Power vs. Tuning Voltage, Vcc = +5V**

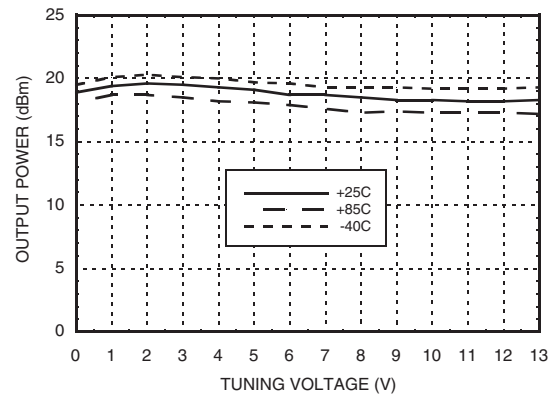

**SSB Phase Noise vs. Tuning Voltage**

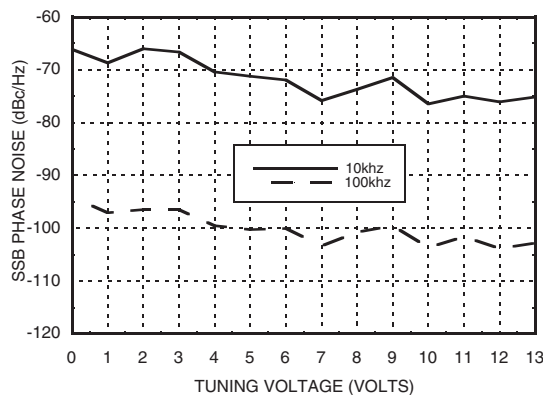

**SSB Phase Noise @ Vtune = +5V**

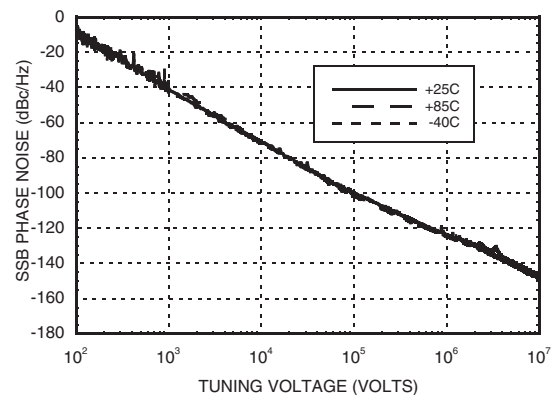

Information furnished by Analog Devices is believed to be accurate and reliable. However, no responsibility is assumed by Analog Devices for its use, nor for any infringements of patents or other rights of third parties that may result from its use. Specifications subject to change without notice. No license is granted by implication or otherwise under any patent or patent rights of Analog Devices. Trademarks and registered trademarks are the property of their respective owners.

For price, delivery, and to place orders: Analog Devices, Inc., One Technology Way, P.O. Box 9106, Norwood, MA 02062-9106 Phone: 781-329-4700 • Order online at [www.analog.com](http://www.analog.com) Application Support: Phone: 1-800-ANALOG-D



## MMIC VCO w/ DIVIDE-BY-4 8.6 - 10.2 GHz

**Divide-by-4 Frequency vs. Tuning Voltage, Vcc = +5V**

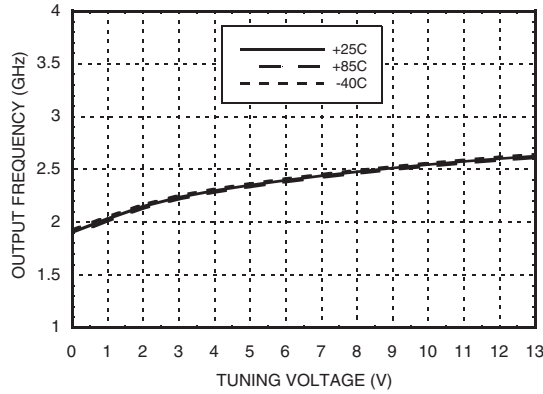

**Divide-by-4 Output Power vs. Tuning Voltage, Vcc = +5V**

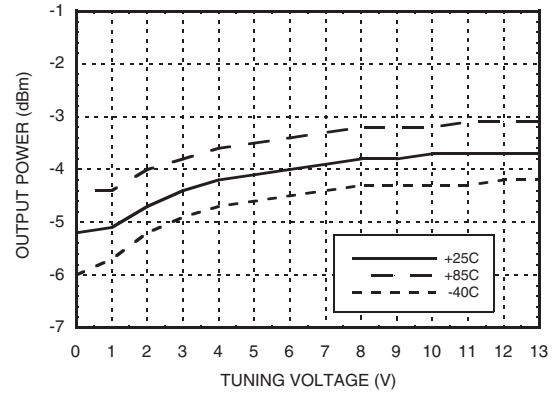

### Outline Drawing

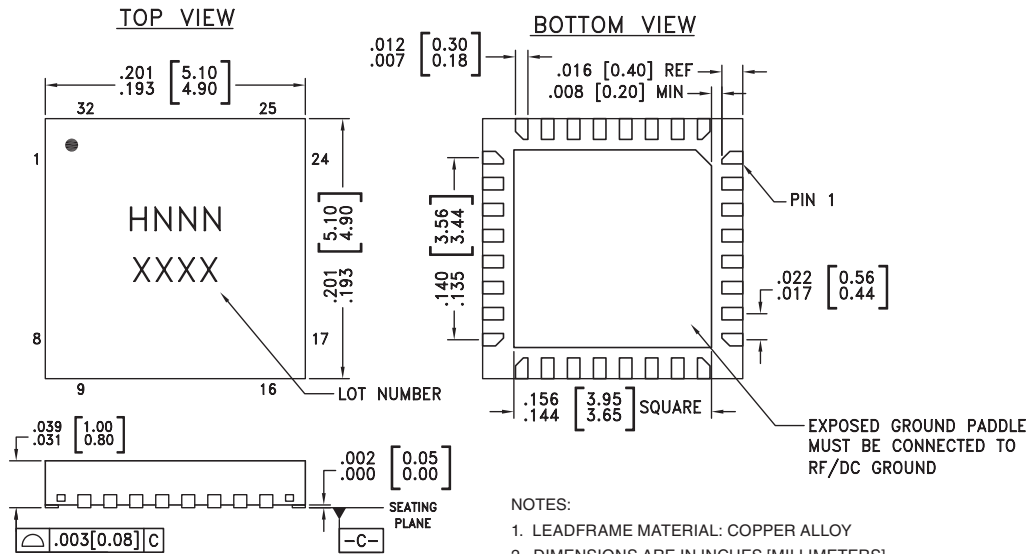

### Package Information

Part Number	Package Body Material	Lead Finish	MSL Rating	Package Marking <sup>[3]</sup>
HMC734LP5	Low Stress Injection Molded Plastic	Sn/Pb Solder	MSL3 <sup>[1]</sup>	H734 XXXX
HMC734LP5E	RoHS-compliant Low Stress Injection Molded Plastic	100% matte Sn	MSL3 <sup>[2]</sup>	H734 XXXX

[1] Max peak reflow temperature of 235 °C

[2] Max peak reflow temperature of 260 °C

[3] 4-Digit lot number XXXX



## MMIC VCO w/ DIVIDE-BY-4 8.6 - 10.2 GHz

### Absolute Maximum Ratings

Vcc(Dig), Vcc(Amp), Vcc(RF)	+5.5 Vdc
Vtune	0 to +15V
Junction Temperature	135 °C
Continuous P <sub>diss</sub> (T=85 °C) (derate 25.3 mW/C above 85 °C)	1.3 W
Thermal Resistance (junction to ground paddle)	39.5 °C/W
Storage Temperature	-65 to +150 °C
Operating Temperature	-40 to +85 °C

### Typical Supply Current vs. Vcc



Vcc (V)	I <sub>cc</sub> (mA)
4.75	198
5.00	218
5.25	237

Note: VCO will operate over full voltage range shown above.

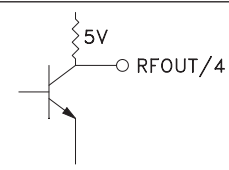
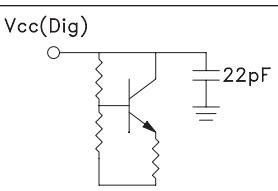
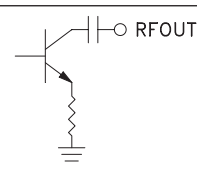
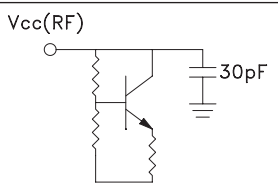
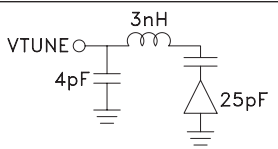

**ELECTROSTATIC SENSITIVE DEVICE  
OBSERVE HANDLING PRECAUTIONS**

### Pin Descriptions

Pin Number	Function	Description	Interface Schematic
1 - 3, 7 - 10, 12 - 17, 20, 22 - 28, 30 - 32	N/C	No Connection. These pins may be connected to RF/DC ground. Performance will not be affected.	
4	RFOUT/4	Divide-by-4 output. DC block required.	
6	Vcc (Dig)	Supply voltage for prescaler. If prescaler is not required, this pin may be left open to conserve approximately 100 mA of current.	
19	RFOUT	RF output (AC coupled).	
21	Vcc (RF)	Supply Voltage, +5V	
29	VTUNE	Control voltage and modulation input. Modulation bandwidth dependent on drive source impedance. See "Determining the FM Bandwidth of a Wideband Varactor Tuned VCO" application note.	
5, 11, 18, Paddle	GND	Package bottom has an exposed metal paddle that must be connected to RF/DC ground.	



**MMIC VCO w/ DIVIDE-BY-4  
8.6 - 10.2 GHz**

**Application Circuit**

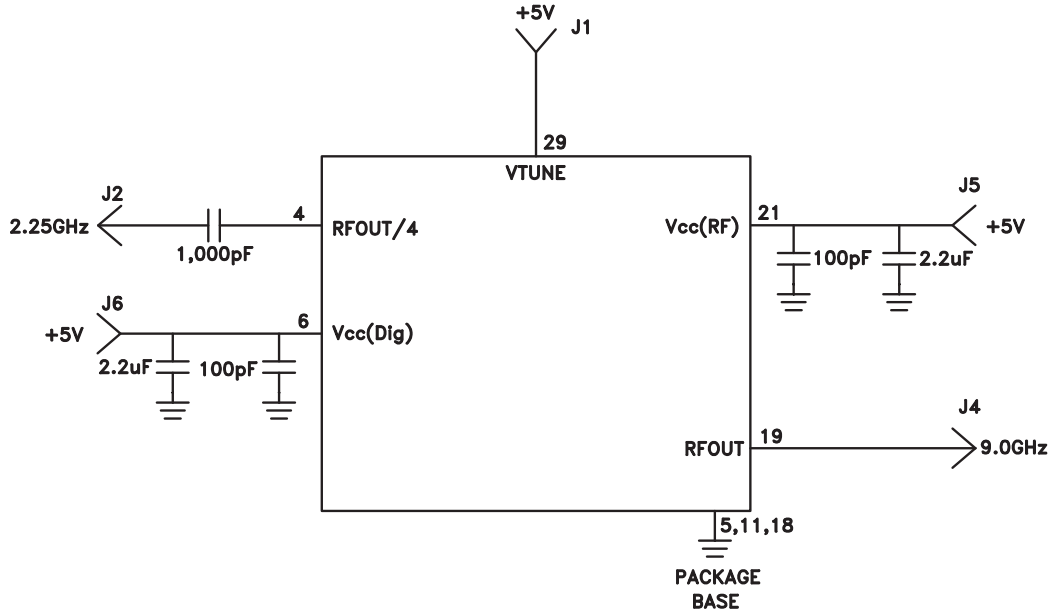

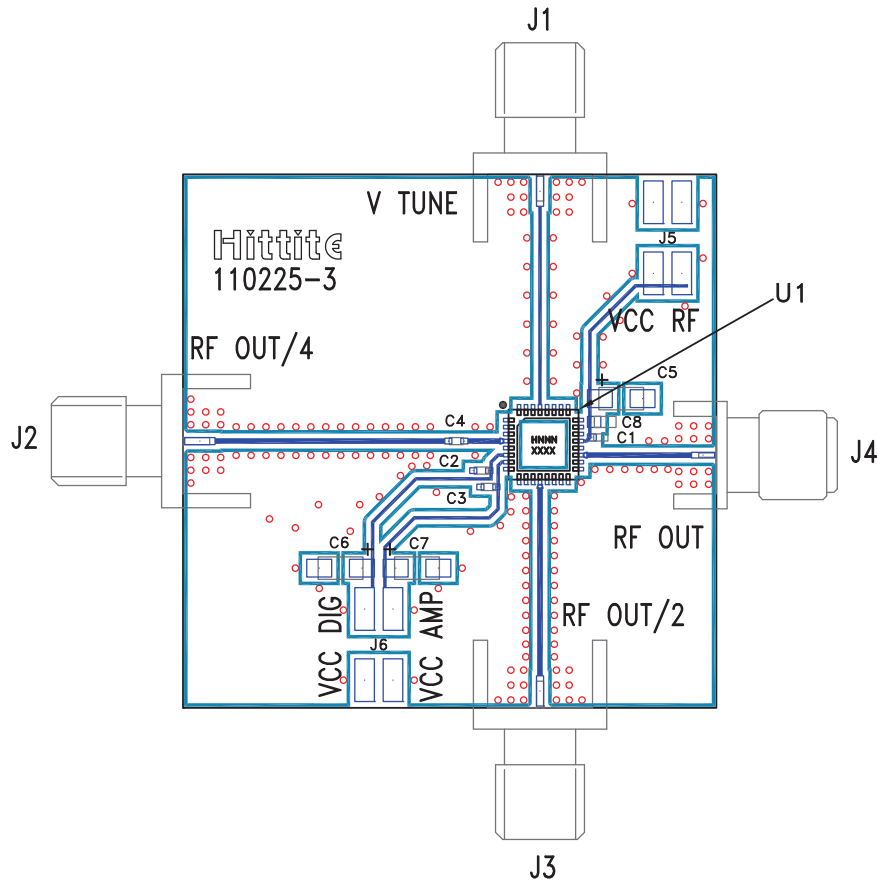
**Evaluation PCB**

**List of Materials for Evaluation PCB 110227 [1]**

Item	Description
J1 - J4	PCB Mount SMA RF Connector
J5 - J6	2 mm DC Header
C1 - C3	100 pF Capacitor, 0402 Pkg.
C4	1,000 pF Capacitor, 0402 Pkg.
C5 - C7	2.2 $\mu$ F Tantalum Capacitor
U1	HMC734LP5(E) VCO
PCB [2]	110225 Eval Board

[1] Reference this number when ordering complete evaluation PCB

[2] Circuit Board Material: Rogers 4350 or Arlon 25FR

The circuit board used in the application should use RF circuit design techniques. Signal lines should have 50 Ohm impedance while the package ground leads and backside ground paddle should be connected directly to the ground plane similar to that shown. A sufficient number of via holes should be used to connect the top and bottom ground planes. The evaluation circuit board shown is available from Hittite upon request.