

## Original installation and operation manual

**BEKOMAT® 12**  
**BEKOMAT® 12 CO**  
**BEKOMAT® 12 CO PN63**

- > BM12
- > BM12CO
- > BM12COPN63

## ■ Table of contents

<b>1. Notes about the documentation</b> .....	<b>4</b>
1.1 Contact .....	4
1.2 Information regarding installation and operation manual .....	4
1.3 Other applicable documents .....	4
<b>2. Safety</b> .....	<b>5</b>
2.1 Use .....	5
2.1.1 Intended use .....	5
2.1.2 Reasonably foreseeable inappropriate use .....	5
2.2 Responsibility of the operating company .....	6
2.3 Target group and personnel.....	7
2.4 Explanation of the symbols used .....	8
2.5 Safety instructions .....	9
<b>3. Product information</b> .....	<b>11</b>
3.1 Product description.....	11
3.2 Product overview .....	11
3.3 Function description .....	12
3.4 Type plate .....	13
3.5 Scope of delivery .....	13
<b>4. Technical data</b> .....	<b>14</b>
4.1 Operating parameters .....	14
4.2 Storage and transport parameters .....	15
4.3 Materials.....	15
4.4 Climatic zones and performance data.....	16
4.4.1 Performance data .....	16
4.5 Dimensions.....	17
4.5.1 BM 12, BM12 CO .....	17
4.5.2 BM 12 CO PN63.....	17
4.6 Installation dimensions.....	18
4.7 Terminal diagrams.....	18
4.7.1 Power control board.....	18
4.7.2 Control PCB.....	18
<b>5. Transport and storage</b> .....	<b>19</b>
5.1 Transport .....	19
5.2 Storage.....	19
<b>6. Assembly</b> .....	<b>20</b>
6.1 Warning notices .....	20
6.1.1 General assembly instructions.....	21
6.2 Assembly of BM12, BM12 CO .....	23
6.3 Assembly of BM12 CO PN63 .....	24

<b>7. Electrical installation</b> .....	<b>25</b>
7.1 Warning notices .....	25
7.2 Connection work .....	26
7.2.1 Voltage supply connection.....	26
7.2.1.1 Power control board AC .....	26
7.2.1.2 Power control board DC .....	29
7.2.2 Connection of potential free contact .....	31
7.2.3 Connection of external TEST .....	32
<b>8. Commissioning</b> .....	<b>33</b>
8.1 Warning notices .....	33
8.2 Commissioning tasks .....	34
<b>9. Operation</b> .....	<b>34</b>
9.1 Operating states .....	34
<b>10. Maintenance</b> .....	<b>36</b>
10.1 Warning notices .....	36
10.2 Maintenance schedule .....	37
10.3 Maintenance work .....	37
10.3.1 Wear parts exchange .....	37
10.3.2 Cleaning work .....	44
10.3.3 Visual inspection .....	46
10.3.4 Leakage test.....	46
<b>11. Consumables, accessories and spare parts</b> .....	<b>46</b>
11.1 Order information.....	46
11.2 Accessories.....	47
11.3 Spare parts.....	48
<b>12. Decommissioning</b> .....	<b>52</b>
12.1 Warning notices .....	52
12.2 Decommissioning work .....	52
<b>13. Disassembly</b> .....	<b>53</b>
<b>14. Disposal</b> .....	<b>54</b>
14.1 Warning notices .....	54
14.2 Disposal work.....	55
<b>15. Troubleshooting / FAQ</b> .....	<b>55</b>
<b>16. Appendices</b> .....	<b>56</b>
16.1 Approval certificates and declarations of conformity.....	56
16.2 Exploded view BM12, BM12 CO.....	58
16.3 Exploded view of BM12 CO PN63 .....	60


# 1. Notes about the documentation

This documentation contains all the necessary steps for installation and operation of the product and the accessories.

## 1.1 Contact

Manufacturer	Customer service and tools
<b>BEKO TECHNOLOGIES GmbH</b>  Im Taubental 7   D-41468 Neuss Tel. + 49 2131 988 - 1000 info@beko-technologies.com www.beko-technologies.com	<b>BEKO TECHNOLOGIES GmbH</b>  Im Taubental 7   D-41468 Neuss Tel. + 49 2131 988 - 1000 service-eu@beko-technologies.com www.beko-technologies.com


## 1.2 Information regarding installation and operation manual

INFORMATION	Copyright protection!
	The contents of the installation and operation manual in the form of text, figures, illustrations, photographs, technical drawings, diagrams and other representations are protected by the copyright of the manufacturer. This applies especially to duplication, reproduction, microfilming and storage as well as processing in electronic systems.

Publication date	Revision	Version	Reason for amendment	Scope of amendment
01/12/2019	00	00	Changes to standards and regulations	Completely new version

The installation and operation manual, hereinafter referred to as the manual, must always be kept close to the product and be in a permanently legible condition.

The manual must be handed over along with the product if it is sold or passed on.

NOTE	Follow the instructions given in the manual!
	This manual contains all the basic information required for safe operation of the product and must therefore be read before any actions are performed. Otherwise personal and material hazards as well as malfunction and device failure are possible.

## 1.3 Other applicable documents

More detailed information can be obtained from the following documents:

- Installation and operation manual: Thermostatically controlled heating system and insulation shell
- Installation and operation manual: Trace heater



## 2. Safety

### 2.1 Use

#### 2.1.1 Intended use

The **BEKOMAT**®, also termed product below, is an electronically level-controlled condensate drain used for draining off condensate in compressed gas systems.

Any use of this system other than the use described in this manual is hereby deemed to be non-intended and can cause a hazard for the safety of people and the environment.

The following must be noted for intended use:

- Read and follow the manual.
- Only operate the product and accessories with media which are free of caustic, aggressive, corrosive, toxic, flammable, oxidising or inorganic components. In cases of doubt an analysis must be carried out.
- Only use the product and the accessories in wet surroundings where only splashwater, free of corroding components, can occur.
- Only use the product and the accessories in areas without CO<sub>2</sub> atmosphere.
- Only use the product and accessories within the operating parameters given in the technical data and the agreed delivery conditions.
- Only use the product and accessories within pipework designed for the technical data with appropriate connections, pipe diameters and assembly clearance.
- Only use the product and accessories in areas which are free of toxic and corrosive chemicals and gases.
- Only use the product and accessories outside potentially explosive atmospheres.
- Only use the product and accessories indoors and away from direct solar radiation and heat sources as well as areas subject to frost.
- Only combine the product and accessories with the products named and recommended by **BEKO TECHNOLOGIES GmbH** in the manual.
- Adhere to the prescribed maintenance schedule.

Before using the product and the accessories, the operating company must make sure that all conditions and prerequisites for intended use are given.

The product and the accessories have been exclusively designed for use in a commercial or industrial area. All the assembly, installation, operation, disassembly and disposal work described may only be performed by qualified skilled technical personnel.

#### 2.1.2 Reasonably foreseeable inappropriate use

Reasonably foreseeable inappropriate use is deemed to have occurred if the product or the accessories are used in any other way than that described in the chapter "Intended use". Reasonably foreseeable inappropriate use includes the use of the product or the accessories in a manner not intended by the manufacturer or supplier but which may result from foreseeable human behaviour.

Reasonably foreseeable inappropriate use includes:

- The execution of any kind of modification, in particular constructive and process-technology related interventions.
- The suspension, bridging or non-application of existing or recommended safety equipment.

This list is not exhaustive as not all possible inappropriate use can be foreseen in advance. If the operating company is aware of any inappropriate use of the product or accessories which are not listed here, the manufacturer must be informed immediately.


## 2.2 Responsibility of the operating company

The responsible operating company must ensure the following to prevent accidents, incidents and adverse effects on the environment:

- Before all actions, check to ensure that the manual available does in fact belong to the product.
- The product and the accessories are used, serviced and repaired in accordance with the intended use.
- All applicable statutory requirements, safety regulations and accident prevention regulations are being adhered to.
- All regulations and operating guidelines for safe working and information regarding behaviour in the event of accidents and fires are accessible at the operating location at all are times.
- The product and accessories are only used with the recommended and fully operable safety equipment.
- All assembly, installation and maintenance work is carried out by qualified skilled technical personnel only.
- Personnel have the necessary personal protective equipment available and also use this equipment.
- Suitable technical safety measures are taken so that the permissible operating parameters are not exceeded or undershot.

## 2.3 Target group and personnel

This manual addresses the personnel listed below who are involved with work on the product or the accessories.

INFORMATION	Personnel requirements!
	<p>The personnel may not execute any actions on the product or the accessories when they are under the influence of drugs, medications, alcohol or other substances that may impair their consciousness.</p>

### Skilled technical personnel - transport and storage

Skilled technical personnel - transport and storage are people who, due to their training, professional experience and qualifications, have all the necessary skills to safely execute all actions in connection with the transport and storage of the product, to instruct, to recognise possible dangerous situations independently and to execute measures to avoid danger.

The capabilities include, in particular, experience with hoists, forklifts and lifting equipment and knowledge of local laws, standards and guidelines relating to transport and storage.

### Skilled technical personnel - compressed gas technology

Skilled technical personnel - compressed gas technology are people who, due to their training, professional experience and qualification, possess all the necessary capabilities to safely execute actions, and instruct all actions related to compressed gases and pressurised systems, to independently foresee potential hazardous situations and implement appropriate measures to avert any danger.

The capabilities include, in particular, experience in handling measurement and control technology as well as knowledge of the regionally applicable laws, standards and regulations for compressed gas technology.

### Skilled technical personnel - electrical engineering

Skilled technical personnel - electrical engineering are people who, due to their training, professional experience and qualification, have all the necessary capabilities to safely execute all actions related to electricity, to instruct and to independently foresee potential hazardous situations and take appropriate measures to avoid any danger.











The capabilities include, in particular, experience in handling electric voltage plants, measurement and control technology as well as knowledge of the regionally applicable laws, standards and regulations (e.g. VDE 0100 / IEC 60364/ ATEX) applicable for handling electrical technology.

### Skilled technical personnel - customer service

Skilled technical personnel - customer service are people who have the skills and qualifications of the skilled personnel named above. Skilled technical personnel - customer service must have documented proof of training for all work on the product and be authorised.

## 2.4 Explanation of the symbols used

The symbols used below indicate safety-relevant and important information which must be adhered to when handling the product and to ensure safe and optimum operation.


Symbol	Description/Explanation
	General warning symbol (danger, warning, caution)
	Warning: pressure build-up in the pipework
	Warning: electric voltage
	Note the installation and operating manual
	General note
	Wear safety footwear
	Use respiratory protection, protection class FFP 3 (particle-filtering half mask)
	Use protective gloves (cut-proof and liquid-resistant)
	Wear safety goggles with side shields
	General information

## 2.5 Safety instructions

Safety instructions warn against residual risks when handling the product and accessories.






These safety instructions must be strictly observed in order to prevent accidents, personal injury, damage to property and impairments during operation.

### Structural design of the safety instructions:

SIGNAL WORD	Type and source of danger!
 Safety symbol	Possible consequences if the danger is ignored
	<ul style="list-style-type: none"> <li>• Measure to prevent the danger</li> </ul>

### Signal words:

<b>DANGER</b>	<b>Imminent hazard</b> Consequences of non-compliance: Death or serious personal injury
<b>WARNING</b>	<b>Imminent hazard</b> Consequences of non-compliance: Death or serious personal injury are possible
<b>CAUTION</b>	<b>Potential hazard</b> Consequences of non-compliance: Personal injury or damage to property are possible
<b>NOTE</b>	<b>Additional notes, information, tips</b> Consequences of non-compliance: Malfunction and device failure during handling and maintenance are possible. No hazard to people or regarding the safe operation.

<b>DANGER</b>	<b>Operation of plant outside the permissible limit range!</b>
	Operation of the product or accessories outside the permissible limits and operating parameters, unauthorised interference and modifications may result in death or serious injury.
	<ul style="list-style-type: none"> <li>• For safe operation of the product and accessories, always adhere to the limit values, operating parameters and maintenance intervals as well as the set-up and ambient parameters specified on the type plate and in the manual.</li> <li>• Inspect whether the operating parameters have been amended or restricted by the use of accessories.</li> </ul>
<b>DANGER</b>	<b>Pressure build-up in the pipework!</b>
	Death or serious personal injury can result through contact with fast or suddenly escaping compressed gas or through bursting system parts.
	<ul style="list-style-type: none"> <li>• All work on the compressed gas system must be carried out in the depressurised state and with the compressed gas system secured against unintentional pressure build-up.</li> <li>• Set up a safety area around the working area during all assembly, installation, maintenance and repair work.</li> <li>• During all work, prevent people or objects from being affected by condensate or escaping compressed gas.</li> <li>• Before building up pressure in the pipework, check all pipe connections and tighten if necessary.</li> <li>• Slowly pressurise the system with pressure.</li> <li>• Avoid pressure blows and high differential pressures.</li> <li>• Assemble all pipelines without stress.</li> <li>• Avoid any vibrations occurring in the pipe network by using vibration dampers.</li> </ul>
<b>DANGER</b>	<b>Electric voltage!</b>
	There is a danger of death or serious injuries following contact with components which are in contact with electric voltage. Malfunction and device failure as well as material damage can occur.
	<ul style="list-style-type: none"> <li>• The product and the accessories may only be connected to the current supply if they are undamaged.</li> <li>• Only carry out installation, maintenance and repair work on the product and accessories when they have been disconnected and secured against being switched back on again.</li> <li>• Set up a safety area around the working area during all installation, maintenance and repair work.</li> <li>• Only operate the product and accessories with the cover or housing complete and closed.</li> </ul>
<b>DANGER</b>	<b>Use of incorrect spare parts, accessories or materials!</b>
	The use of incorrect spare parts, accessories or materials, as well as auxiliary and operating materials, may result in death or serious injury. Malfunction and device failure as well as material damage can occur.
	<ul style="list-style-type: none"> <li>• For all work, only use undamaged original parts, auxiliary and operating materials which are specified by the manufacturer.</li> <li>• Use only the approved materials and suitable tools for the respective purpose and make sure that they are in proper working order.</li> <li>• Only use cleaned pipes that are free of dirt and corrosion.</li> </ul>
<b>CAUTION</b>	<b>Polluted condensate!</b>
	Contact with condensate containing substances which endanger health and the environment can pose a health hazard, causing irritation and/or damage to the eyes, skin and mucous membranes. Polluted condensate must be prevented from entering the sewerage system, waters or the ground.
	<ul style="list-style-type: none"> <li>• Use personal protective equipment.</li> <li>• Pick up and dispose of any escaped or spilled condensate in line with local regulations.</li> </ul>

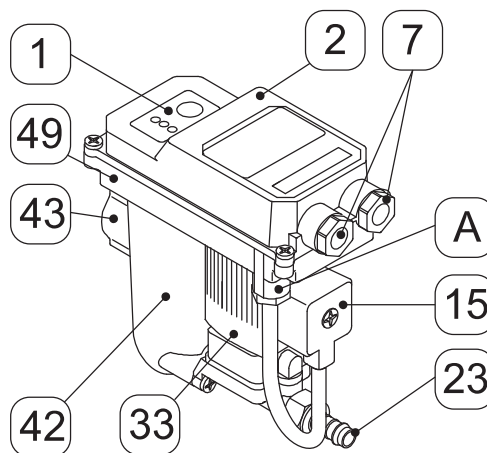
## 3. Product information

### 3.1 Product description

The **BEKOMAT®** is an electronically level-controlled condensate drain used for draining off condensate in compressed gas systems.

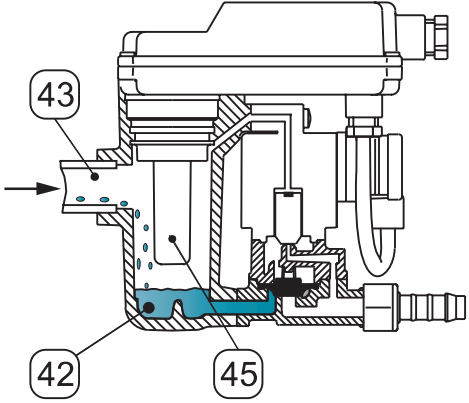
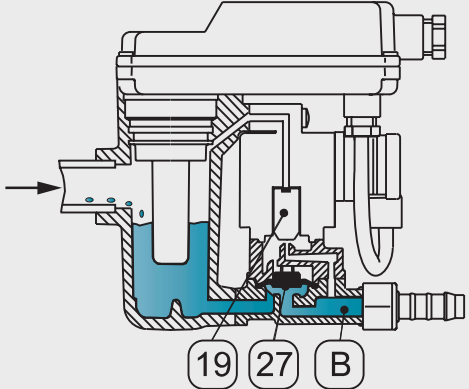
The condensate formed is collected in the **BEKOMAT®** and the filling level is monitored by an integrated capacitive sensor. When the defined filling level is reached, the condensate is discharged via a pilot-controlled solenoid valve.

### 3.2 Product overview



Item	Description / explanation	Item	Description / explanation
[1]	Operating label with TEST button	[23]	Hose connection (not with <b>BEKOMAT® 12 CO PN63</b> )
[2]	Top cover	[33]	Solenoid valve
[7]	<b>Cable glands</b> right: Voltage supply left: potential-free contact	[42]	Housing
[A]	Cable gland solenoid valve	[43]	Condensate inlet
[15]	Solenoid valve connector	[49]	Bottom cover

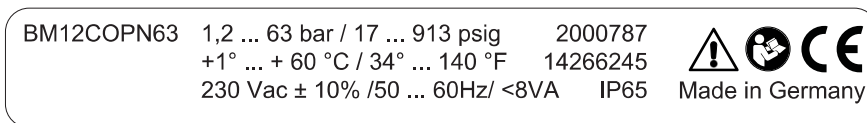
### 3.3 Function description

Illustration	Description / explanation
 <p>A cross-sectional diagram of the BEKOMAT® valve assembly. An arrow on the left points to the condensate inlet [43], which leads into a chamber. The chamber is labeled as the housing [42]. Inside the housing, a sensor tube [45] is positioned to monitor the liquid level. Blue dots representing condensate are shown entering the housing and pooling at the bottom.</p>	<p>The condensate flows via the condensate inlet [43] into the <b>BEKOMAT®</b> and collects in the housing [42]. The filling level in the housing [42] is permanently monitored by a capacitive sensor in the sensor tube [45].</p>
 <p>A cross-sectional diagram of the BEKOMAT® valve assembly in an actuated state. An arrow on the left points to the condensate inlet. The valve core [19] is shown moving downwards, pushing against a membrane [27]. This action opens a passage labeled [B], through which blue liquid (condensate) is being discharged from the housing.</p>	<p>The control actuates the pilot valve with valve core [19] and the membrane [27] opens the condensate discharge [B] to the condensate drain system.</p> <p>Once the <b>BEKOMAT®</b> has been emptied, the condensate discharge [B] is closed tightly again before any loss of compressed gas can occur.</p>



### 3.4 Type plate

The type plate is located on the housing and contains all the identification and operating parameters of the **BEKOMAT®**. If you contact the manufacturer or supplier, always have this data ready for system identification.



Example illustrations

Position on type plate	Description / explanation
<b>BM12COPN63</b>	Product name
<b>1.2 ... 63 bar / 17 ... 913 psig</b>	Operating pressure
<b>+1° ... +60°C / 34° ... 140 °F</b>	Operating temperature
<b>230 Vac ± 10% / 50-60Hz/ &lt;8VA</b>	Operating voltage
<b>2000787</b>	Order reference
<b>14266245</b>	Serial number
<b>IP65</b>	IP degree of protection

<b>NOTE</b>	<b>Handling the type plate!</b>
	Never damage, remove or make the type plate illegible.

For more information regarding the symbols, refer to “2.4 Explanation of the symbols used” on Page 8.

### 3.5 Scope of delivery

The table below shows the scope of delivery of the **BEKOMAT®**:

Illustration	Description / explanation
	<b>BEKOMAT®</b>
	Original installation and operation manual

## 4. Technical data

### 4.1 Operating parameters

BEKOMAT®	12	12 CO	12 CO PN63
Min. / max. operating pressure	0.8 ... 16 bar(g) 12 ... 230 psi(g)		1.2 ... 63 bar(g) 18 ... 913 psi(g)
Min. / max. operating temperature	+1 ... +60 °C +34 ... +140 °F		
Min. / max. ambient temperature	+1 ... +60 °C +34 ... +140 °F		
Min. / max. ambient air humidity	10 ... 80 %, non-condensing		
Condensate inlet	G1/2 (internal thread) 1/2" NPT (internal thread)		
Condensate discharge	G3/8 (internal thread)		
Media	Condensate, oil-contaminated	Condensate, oil-contaminated + oil-free	
Empty weight	0.8 kg 1.8 lbs		0.9 kg 2.0 lbs
Operating voltage	230 / 115 / ... / 24 VAC ± 10%, 50 ... 60 Hz / 24 VDC ± 10% See type plate		
Power consumption	P < 8.0 VA (W)		
Fuse protection	recommended for AC: 1 A (time-lag)   prescribed for DC: 1 A (time-lag)		
Recommended cable diameter	5.8 ... 8.5 mm 0.23 ... 0.34 inch		
Recommended wire cross-section (voltage supply)	3 x 0.75 ... 1.5 mm <sup>2</sup> AWG 16 ... 18		
Recommended shortening of the cable jacket	PE= ~ 60 mm ~ 2.3 inch L N= ~ 50 mm ~ 1.96 inch	PE= ~ 60 mm ~ 2.3 inch L N= ~ 50 mm ~ 1.96 inch	PE= ~ 60 mm ~ 2.3 inch L N= ~ 50 mm ~ 1.96 inch
Recommended stripping length of the cable wires	~ 6 mm ~ 0.24 inch		
Connection data potential-free contact for switching load	AC: max. 250 V / 1A   DC: max. 30 V / 1A		
Degree of protection	IP65 / NEMA 13		
Overvoltage category	II		
Degree of pollution	3		

## 4.2 Storage and transport parameters

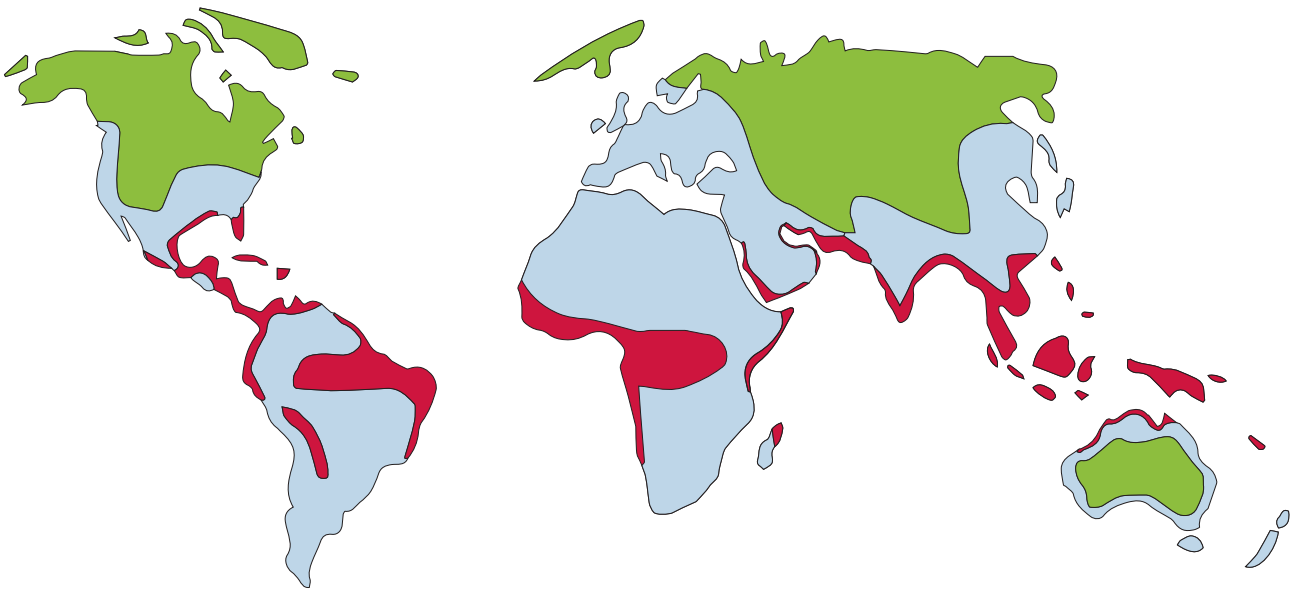
BEKOMAT®	12	12 CO	12 CO PN63
Min. / max. storage and transport temperature		+1 ... +60 °C +34 ... +140 °F	

## 4.3 Materials

BEKOMAT®	12	12 CO	12 CO PN63
Housing	Aluminium	Aluminium, hardcoated	
Membrane	FKM		

## 4.4 Climatic zones and performance data

Depending on which climatic zone the product is used in, the product performance differs depending on the climatic ambient conditions.



Climatic zone	Max. compressor performance		Max. dryer performance		Max. filter performance		
	Unit	m <sup>3</sup> /min.	cfm	m <sup>3</sup> /min.	cfm	m <sup>3</sup> /min.	cfm
green		8.0	283	16.0	565	80.0	2825
blue		6.5	230	13.0	459	65.0	2300
red		4.0	141	8.0	283	40.0	1413

The performance data given refer to a moderate climate valid for Europe, large parts of South-East Asia, North and South Africa, parts of North and South America (climatic zone: blue).

For a dry and / or cool climate (climatic zone: green), the following factor applies:

Performance in climatic zone "blue"  $\times$  approx. 1.2

For a hot and / or humid climate (tropics, climatic zone: red), the following factor applies:

Performance in climatic zone "blue"  $\times$  approx. 0.7

### 4.4.1 Performance data

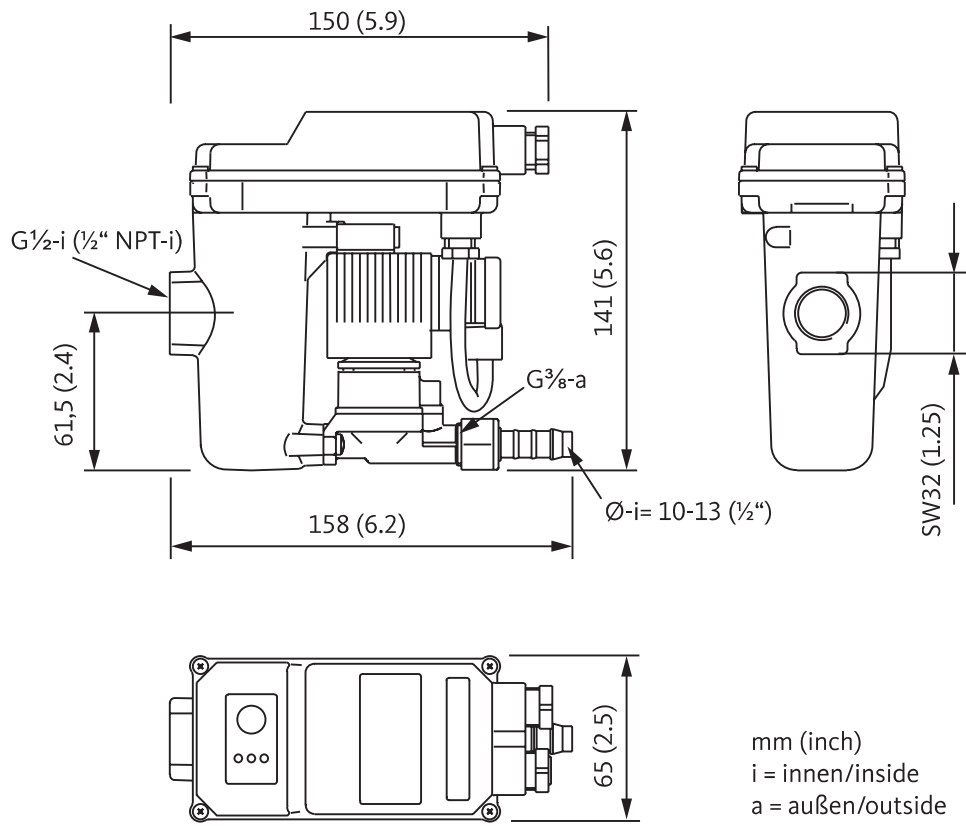
BEKOMAT®	12	12 CO	12 CO PN63
Max. compressor performance		6.5 m <sup>3</sup> /min 230 cfm	
Max. refrigeration dryer performance		13 m <sup>3</sup> /min 460 cfm	
Max. filter performance		65 m <sup>3</sup> /min 2300 cfm	

Operating pressure	1 bar(g) 14.5 psi(g)	2 bar(g) 29.01 psi(g)	3 bar(g) 43.51 psi(g)	4 bar(g) 58.02 psi(g)	5 bar(g) 72.52 psi(g)	≥ 6 bar(g) 87.02 psi(g)
Ø discharge rate	0.95 l/h 0.25 gal/h	1.10 l/h 0.29 gal/h		1.29 l/h 0.34 gal/h		1.43 l/h 0.37 gal/h
Max. discharge rate (short-term)*	20 l/h 5.28 gal/h	23 l/h 6.07 gal/h		27 l/h 7.13 gal/h		30 l/h 7.92 gal/h

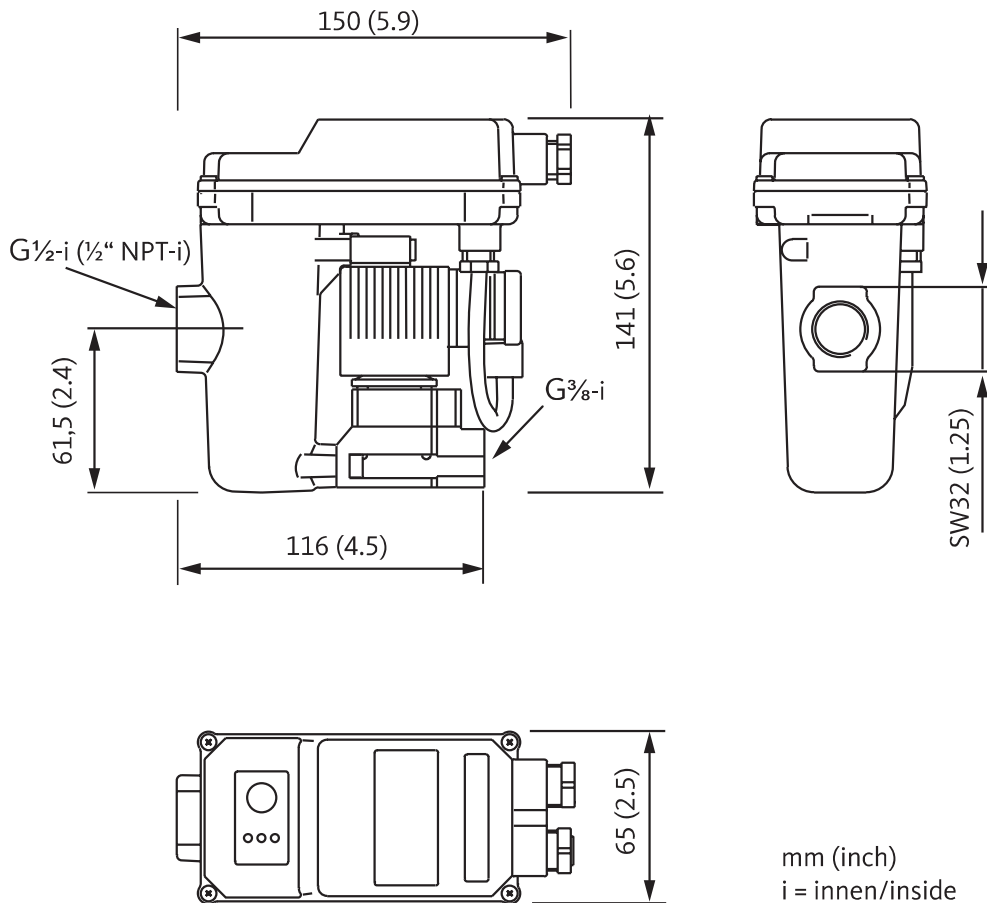
\* The peak volume can only be achieved if the device is correctly installed according to the installation and operation manual. If in doubt, a venting line must be installed.

## 4.5 Dimensions

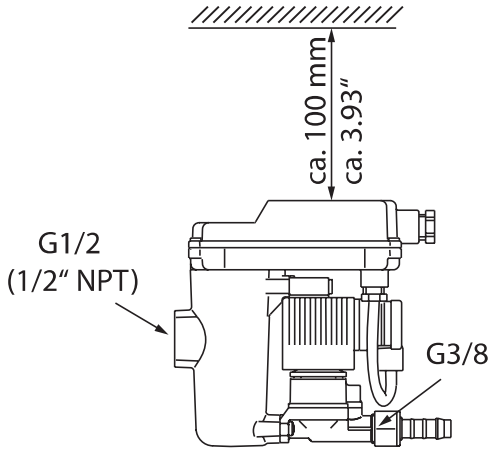
### 4.5.1 BM 12, BM12 CO



### 4.5.2 BM 12 CO PN63

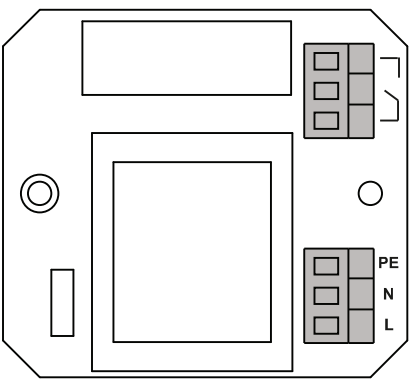
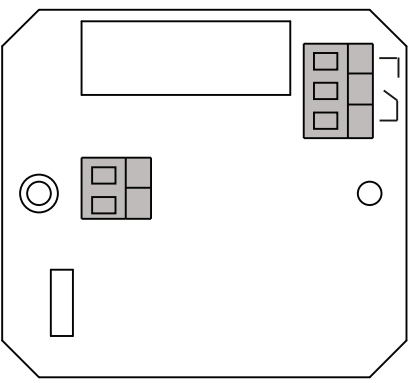


## 4.6 Installation dimensions

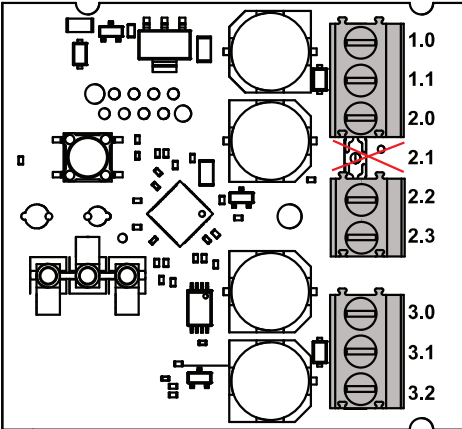
Illustration	Description / explanation
 <p>G1/2 (1/2" NPT)</p> <p>G3/8</p>	<p>At the place of installation, allow sufficient assembly space above the top cover so that the LEDs are visible and the TEST button can be pressed.</p>

## 4.7 Terminal diagrams





### 4.7.1 Power control board

Illustration VAC board	Illustration VDC board											
 <table border="1" data-bbox="558 1086 766 1198"> <tr><td>Normally Open (NO)</td></tr> <tr><td>Common (CO)</td></tr> <tr><td>Normally Closed (NC)</td></tr> </table> <table border="1" data-bbox="558 1288 766 1400"> <tr><td>Schutzleiter (PE)</td></tr> <tr><td>Neutralleiter (N)</td></tr> <tr><td>Phase (L)</td></tr> </table>	Normally Open (NO)	Common (CO)	Normally Closed (NC)	Schutzleiter (PE)	Neutralleiter (N)	Phase (L)	 <table border="1" data-bbox="1220 1086 1428 1198"> <tr><td>Normally Open (NO)</td></tr> <tr><td>Common (CO)</td></tr> <tr><td>Normally Closed (NC)</td></tr> </table> <table border="1" data-bbox="1220 1198 1428 1276"> <tr><td>24V+</td></tr> <tr><td>24V-</td></tr> </table>	Normally Open (NO)	Common (CO)	Normally Closed (NC)	24V+	24V-
Normally Open (NO)												
Common (CO)												
Normally Closed (NC)												
Schutzleiter (PE)												
Neutralleiter (N)												
Phase (L)												
Normally Open (NO)												
Common (CO)												
Normally Closed (NC)												
24V+												
24V-												

### 4.7.2 Control PCB

Illustration										
	<table border="1" data-bbox="965 1624 1077 1870"> <tr><td>+24V</td></tr> <tr><td>0V</td></tr> <tr><td>OT1</td></tr> <tr><td><del>2.1</del></td></tr> <tr><td>INP1</td></tr> <tr><td>0V</td></tr> </table> <p data-bbox="1109 1635 1372 1724">Voltage supply from the power control board</p> <p data-bbox="1109 1747 1252 1780">not assigned</p> <p data-bbox="1109 1803 1332 1836">External test button</p> <table border="1" data-bbox="965 1904 1077 2027"> <tr><td>0V</td></tr> <tr><td>+24V</td></tr> <tr><td>OT2</td></tr> </table> <p data-bbox="1109 1948 1276 1982">Solenoid valve</p>	+24V	0V	OT1	<del>2.1</del>	INP1	0V	0V	+24V	OT2
+24V										
0V										
OT1										
<del>2.1</del>										
INP1										
0V										
0V										
+24V										
OT2										

## 5. Transport and storage

<b>WARNING</b>	<b>Insufficient qualification!</b>
	Insufficient qualification of the personnel can lead to accidents, personal injury and damage to the device as well as impairments in operation during work on the product.
	The work on the product described below may only be executed and documented by skilled technical personnel - transport and storage.
<b>CAUTION</b>	<b>Inappropriate transport or storage!</b>
 	Inappropriate transport or storage may result in personal injury or damage to the device.
	<ul style="list-style-type: none"> <li>• Wear protective gloves when working with packaging material</li> <li>• Use personal protective equipment, inspect it regularly for faultlessness and functionality and replace damaged parts immediately.</li> <li>• Handle packaging and product with care.</li> <li>• Pack all parts impact-proof using suitable material.</li> <li>• Transport and handle the packaging according to the markings (observe lifting gear attachment points, the centre of gravity and orientation e.g. keep vertical, do not throw etc.).</li> <li>• Use proper means of transport and lifting equipment that is in proper working order.</li> <li>• Always adhere to the specified transport and storage parameters.</li> <li>• Store the product only outside of areas exposed to direct sunlight and heat sources.</li> </ul>
<b>NOTE</b>	<b>Handling packaging material!</b>
	Inappropriate disposal of packaging materials can cause environmental damage.
	<ul style="list-style-type: none"> <li>• Dispose of the packaging material in accordance with the regional laws, provisions, guidelines and regulations of the country and place of use.</li> </ul>

### 5.1 Transport

After transporting and removing the packaging material, inspect the product for possible transport damage. If you detect any damage, immediately notify the carrier company and **BEKO TECHNOLOGIES GMBH** or one of its agents.

Transport the product as follows:

- Only transport the product packaged.
- Handle packaging and the product with care.
- Note the transport weight specification and marking on the packaging.
- Secure the packaging and the product against slipping and falling during transport.





### 5.2 Storage

Store the product and the accessories as follows:

- Adhere to the storage conditions in chapter **“4.2 Storage and transport parameters” on Page 15**.
- Store in a closed, dry as well as frost-free room.
- Store protected from external influences of the weather, direct sunlight and sources of heat.
- Secure against falling over and protect against vibrations at the storage location.

## 6. Assembly

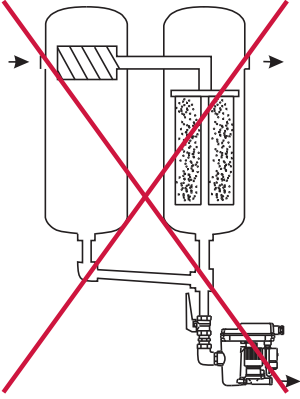
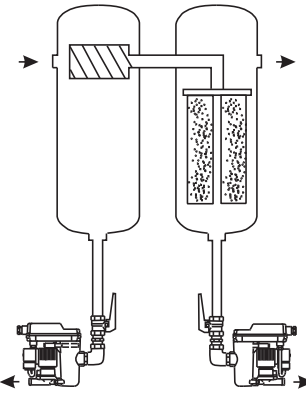

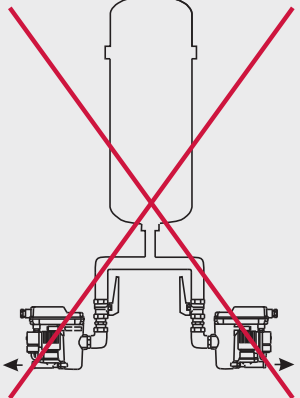
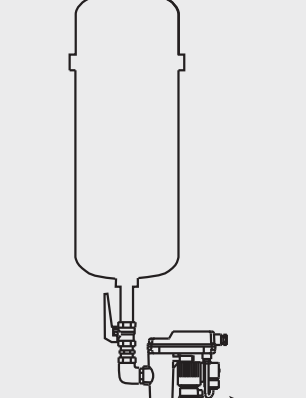

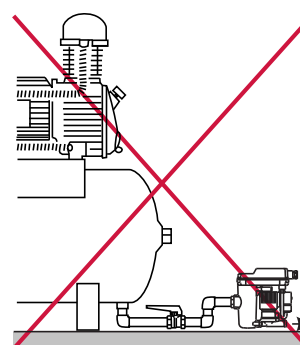
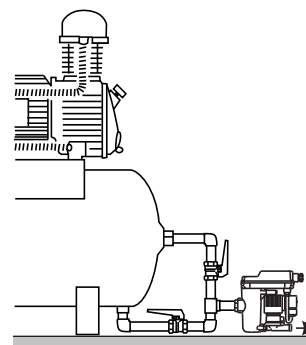

### 6.1 Warning notices

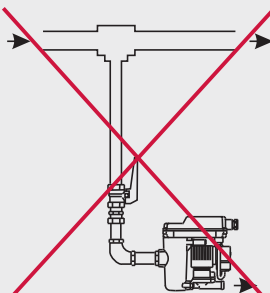
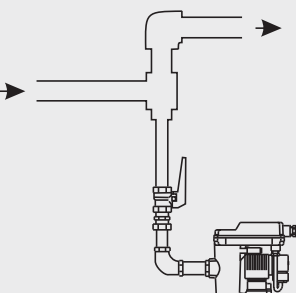

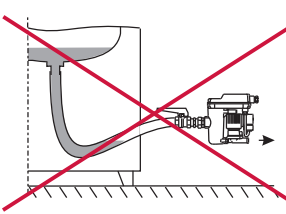
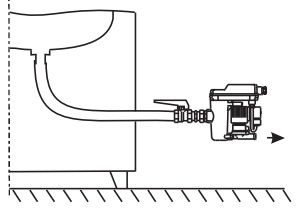

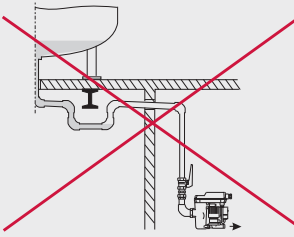
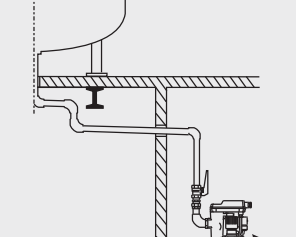

<b>DANGER</b>	<b>Use of incorrect spare parts, accessories or materials!</b>
	<p>The use of incorrect spare parts, accessories or materials, as well as auxiliary and operating materials, may result in death or serious injury. Malfunction and device failure as well as material damage can occur.</p> <ul style="list-style-type: none"> <li>• For all work, only use undamaged original parts, auxiliary and operating materials which are specified by the manufacturer.</li> <li>• Use only the approved materials and suitable tools for the respective purpose and make sure that they are in proper working order.</li> <li>• Only use pipes that are free of dirt, damage and corrosion.</li> </ul>
<b>DANGER</b>	<b>Pressure build-up in the pipework!</b>
	<p>Death or serious personal injury can result through contact with fast or suddenly escaping compressed gas or through bursting system parts.</p> <ul style="list-style-type: none"> <li>• All work on the compressed gas system must be carried out in the depressurised state and with the compressed gas system secured against unintentional pressure build-up.</li> <li>• Set up a safety area around the working area during all assembly, installation, maintenance and repair work.</li> <li>• Before building up pressure in the pipework, check all pipe connections and tighten if necessary.</li> <li>• Slowly pressurise the system with pressure.</li> <li>• Avoid pressure blows and high differential pressures.</li> <li>• Assemble all pipelines without stress.</li> <li>• Avoid any vibrations occurring in the pipe network by using vibration dampers.</li> <li>• Install pipes tightly as feed and discharge lines.</li> </ul>
<b>WARNING</b>	<b>Insufficient qualification!</b>
	<p>Insufficient qualification of the personnel carrying out work on the product and accessories can lead to accidents, personal injury and damage to property as well as impair operation.</p> <ul style="list-style-type: none"> <li>• All work on the product and accessories may only be carried out by skilled technical personnel - compressed gas technology.</li> </ul>
<b>CAUTION</b>	<b>Inappropriate assembly!</b>
	<p>Inappropriate assembly of the product and the accessories can lead to personal injury and damage to property as well as impair operation.</p> <ul style="list-style-type: none"> <li>• Fix hoses in such a way that they do not flap around.</li> <li>• Note the specified assembly instructions at all times.</li> </ul>



### 6.1.1 General assembly instructions


Note the following assembly instructions at all times.

Wrong	Right	Description / explanation
		 <p><b>Bypassing the filter!</b> Drain each point where condensate occurs separately in order to avoid bypassing the filters!</p>
		 <p><b>Avoid pressure ranges!</b> Drain each point where condensate occurs using a <b>BEKOMAT®</b> to avoid pressure ranges in the pipework!</p>
		 <p><b>Ensure sufficient venting!</b> If the gradient in the inflow is not sufficient or there are other problems with the inflow, a venting line must be laid!</p>

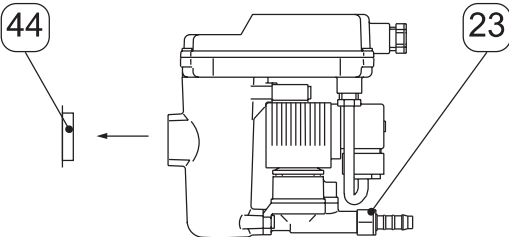
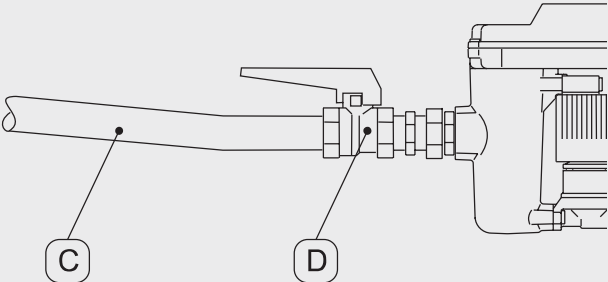
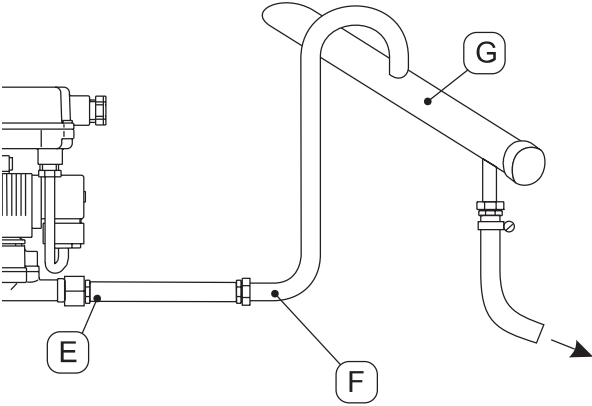
Wrong	Right	Description / explanation
		 <p><b>Deflecting surface!</b> In the case of direct drainage from the compressed gas line a deflection of the compressed gas flow is necessary!</p>
		 <p><b>Continuous slope!</b> If a pressure hose is used for inflow, avoid the formation of a water pocket!</p>
		 <p><b>Continuous slope!</b> When laying pipes for the feed line, avoid the formation of a water pocket.</p>

## 6.2 Assembly of BM12, BM12 CO

For assembly work to be carried out, the following prerequisites must be fulfilled and the preparatory tasks must have been completed.


Prerequisites		
Tools	Material	Protective equipment
<ul style="list-style-type: none"> <li>e.g. adjustable spanner</li> </ul>	<ul style="list-style-type: none"> <li>Sealants</li> <li>Feed line and discharge line</li> </ul>	<p><b>Always to be worn:</b></p> 

Preparatory tasks	
1.	Depressurise the compressed gas system or the respective system section and secure it against unintentional pressure build-up.

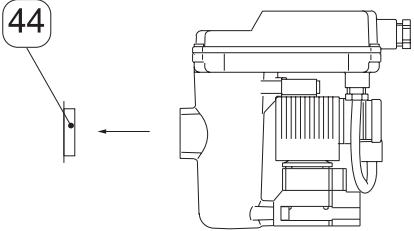
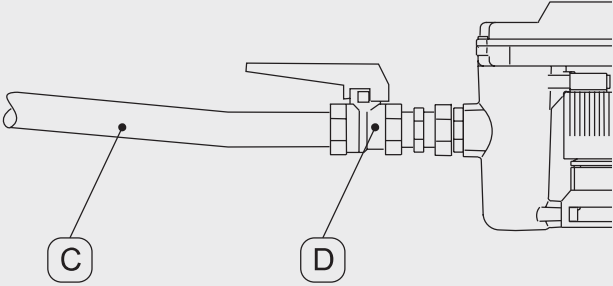
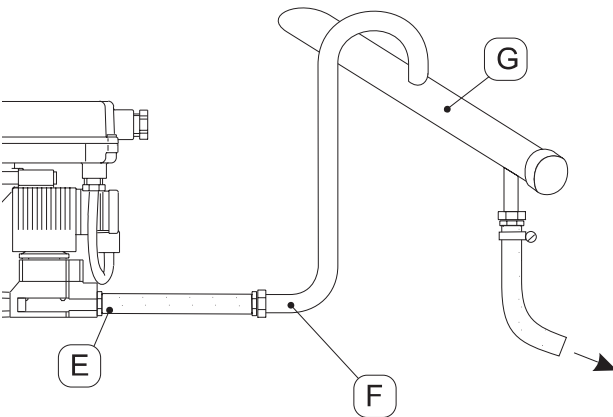
Illustration	Description / explanation
	<ol style="list-style-type: none"> <li>Remove the dust cap [44].</li> <li>Screw the enclosed hose connection [23] to the condensate discharge.</li> </ol>
	<p><b>Assembly instructions</b></p> <ul style="list-style-type: none"> <li>The gradient of the condensate inlet line [C] must be <math>\geq 3\%</math>.</li> <li>Do not mount any filters in the condensate inlet line [C].</li> <li>The diameter of the condensate inlet line [C] must be <math>\geq 1/2"</math> (inner diameter <math>\geq 13</math> mm (0.5")).</li> <li>The cross-section of the manifold must correspond to at least the sum of the individual cross-sections.</li> <li>Do not reduce any of the given line cross-sections e.g. by means of reducing nipples.</li> <li><b>Recommended interval:</b> Equip the condensate inlet line [C] with a shut-off valve [D] to make simple product maintenance possible.</li> </ul> <ol style="list-style-type: none"> <li>For the condensate inlet line [C] apply sealant to the end of the pressure-resistant pipe and screw in at the condensate inlet.</li> </ol>
	<p><b>Assembly instructions</b></p> <ul style="list-style-type: none"> <li>The condensate discharge line [F] may be max. 10 m (32.8 ft) long and laid rising by max. 5 m (17 ft). The minimum pressure required increases by 0.1 bar (1.5 psi) per metre of incline.</li> <li>The diameter of the manifold [G] must be <math>\geq 1/2"</math> and the gradient <math>\geq 3\%</math>.</li> <li>Do not use shut-off valves in the condensate discharge.</li> <li>Do not kink or block the pressure hose [E], or route it across storage or transport areas.</li> </ul> <ol style="list-style-type: none"> <li>For the drain, connect a short pressure hose [D] (designed for the system pressure) to the condensate discharge and the condensate discharge line [F] using a hose clamp.</li> </ol>

## 6.3 Assembly of BM12 CO PN63

For assembly work to be carried out, the following prerequisites must be fulfilled and the preparatory tasks must have been completed.





Prerequisites		
Tools	Material	Protective equipment
<ul style="list-style-type: none"> <li>e.g. adjustable spanner</li> </ul>	<ul style="list-style-type: none"> <li>Sealants</li> <li>Feed line and discharge line</li> </ul>	<p><b>Always to be worn:</b></p> 

Preparatory tasks	
1.	Depressurise the compressed gas system or the respective system section and secure it against unintentional pressure build-up.
2.	Note the specified assembly instructions at all times.

Illustration	Description / explanation
	<p>3. Remove the dust cap [44].</p>
	<p><b>Assembly instructions</b></p> <ul style="list-style-type: none"> <li>The gradient of the condensate inlet line [C] must be <math>\geq 3\%</math>.</li> <li>Do not mount any filters in the condensate inlet line [C].</li> <li>The diameter of the condensate inlet line [C] must be <math>\geq 1/2"</math> (inner diameter <math>\geq 13</math> mm (0.5")).</li> <li><b>Recommended interval:</b> Equip the condensate inlet line [C] with a shut-off valve [D] to make simple product maintenance possible.</li> </ul> <p>4. For the condensate inlet line [C] apply sealant to the end of the pressure-resistant pipe and screw in at the condensate inlet.</p>
	<p><b>Assembly instructions</b></p> <ul style="list-style-type: none"> <li>The condensate discharge line [F] may be laid rising by max. 5 m (17 ft). The minimum pressure required increases by 0.1 bar (1.5 psi) per metre of incline.</li> <li>The diameter of the manifold [G] must be <math>\geq 1/2"</math> and the gradient <math>\geq 3\%</math>.</li> <li>Do not use shut-off valves in the condensate discharge.</li> </ul> <p>5. For the drain, connect a short pressure hose [E] (designed for the system pressure) to the condensate discharge and the condensate discharge line [F].</p>


## 7. Electrical installation

### 7.1 Warning notices

<b>DANGER</b>	<b>Use of incorrect spare parts, accessories or materials!</b>
	The use of incorrect spare parts, accessories or materials, as well as auxiliary and operating materials, may result in death or serious injury. Malfunction and device failure as well as material damage can occur.
	<ul style="list-style-type: none"> <li>• For all work, only use undamaged original parts, auxiliary and operating materials which are specified by the manufacturer.</li> <li>• Use only the approved materials and suitable tools for the respective purpose and make sure that they are in proper working order.</li> </ul>
<b>DANGER</b>	<b>Electric voltage!</b>
	There is a danger of death or serious injuries as well as malfunction and device failure following contact with components which are in contact with electric voltage.
	<ul style="list-style-type: none"> <li>• Only carry out installation, maintenance and repair work on the product and accessories when they have been disconnected and secured against being switched back on again.</li> <li>• Set up a safety area around the working area during all installation, maintenance and repair work.</li> <li>• For installation of the device, adhere to all applicable regulations (e.g. VDE 0100 / IEC 60364/ ATEX).</li> <li>• Connect the protective conductor (earth connection) according to regulations.</li> </ul>
<b>WARNING</b>	<b>Insufficient qualification!</b>
	Insufficient qualification of the personnel carrying out work on the product and accessories can lead to accidents, personal injury and damage to property as well as impair operation.
	<ul style="list-style-type: none"> <li>• All work on the product and the accessories may only be carried out by skilled technical personnel - electrical engineering.</li> </ul>
<b>CAUTION</b>	<b>Inappropriate electrical installation!</b>
	Inappropriate electrical installation of the product and the accessories can lead to personal injury and damage to property as well as impair operation.
	<ul style="list-style-type: none"> <li>• Check all plug-type connections for a correct fit.</li> <li>• Avoid stumbling hazard through appropriate cable routing.</li> <li>• Avoid mechanical load on the cables through appropriate cable routing.</li> </ul>

## 7.2 Connection work

For connection work to be carried out, the following prerequisites must be fulfilled and the preparatory tasks must have been completed.

Prerequisites		
Tools	Material	Protective equipment
<ul style="list-style-type: none"> <li>Stripping tool</li> <li>Crimping tool for wire-end ferrules</li> <li>Screwdriver - cross-head size 2.5 mm (0.09")</li> <li>Screwdriver - flat-blade size 2.5 mm (0.09")</li> </ul>	<ul style="list-style-type: none"> <li>3-wire cable for voltage supply 230 V</li> <li>2-wire cable for voltage supply 24 V</li> <li>2-wire cable for external test</li> <li>2/3-wire cable for potential-free contact (depending on the application)</li> <li>Wire end ferrules</li> </ul>	<p><b>Always to be worn:</b></p> 

Preparatory tasks	
1.	Assembly must have been completed.
2.	Protect the cables for the voltage supply of the <b>BEKOMAT®</b> in accordance with the specifications in the technical data. AC = 1 A (time-lag) recommended DC = 1 A (time-lag) prescribed
3.	In the case of AC voltage supply an accessible circuit breaker (e.g. power plug or switch) that shuts off all energised conductors must be installed close to the unit.

### 7.2.1 Voltage supply connection

#### 7.2.1.1 Power control board AC

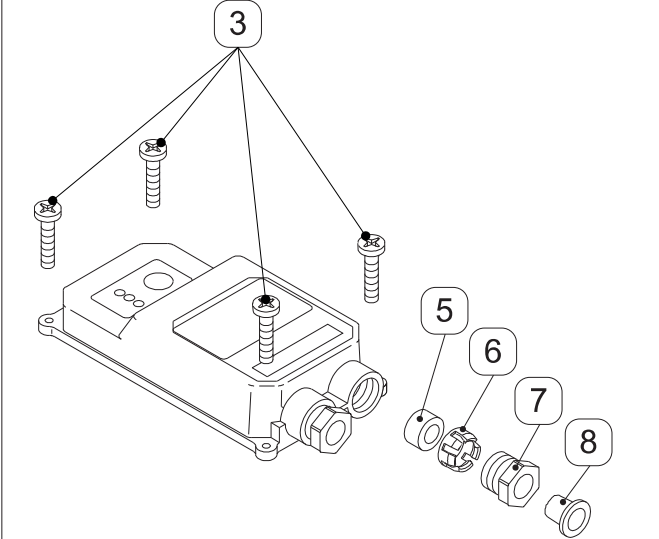
Illustration	Description / explanation
	<p>4. Loosen the 4 pan-head screw [3] in the top cover and unscrew the components of the cable gland [5, 6, 7, 8].</p>

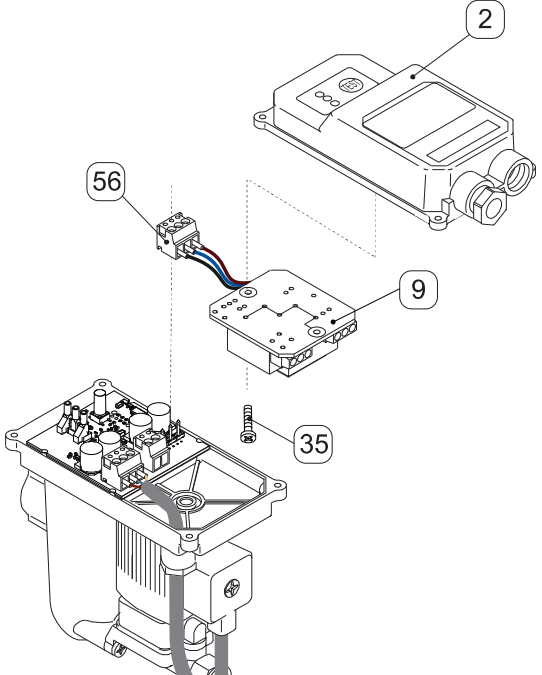
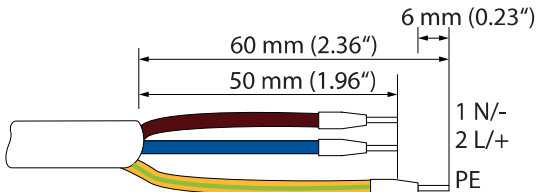
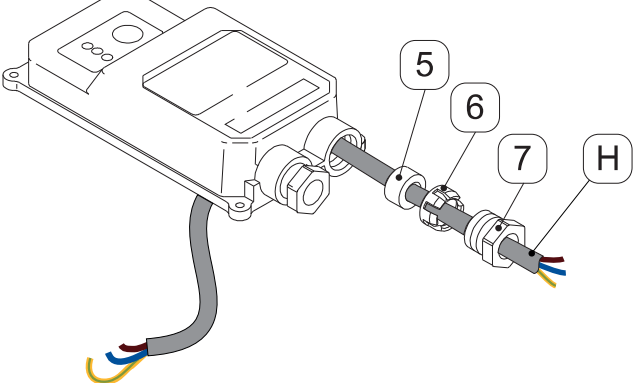
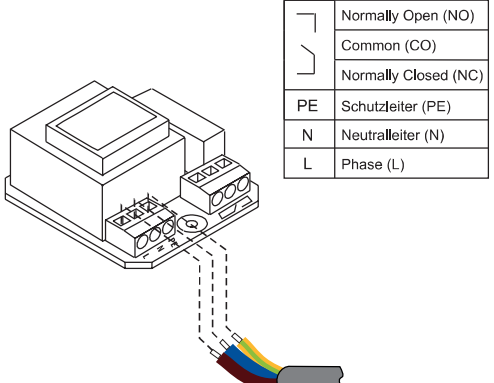
Illustration	Description / explanation												
	<p>5. Raise the top cover [2] a little and pull the screw terminal [56] of the power control board up and off.</p> <p>6. Unscrew the pan-head screw [35] and take the power control board [9] out of the top cover [2].</p>												
	<p>7. Prepare the 3-wire cable of the voltage supply.</p>												
	<p>8. Slide the components of the cable gland [5, 6, 7] over the cable for voltage supply [H] and insert the cable into the top cover.</p>												
 <table border="1" data-bbox="518 1545 726 1724"> <tr> <td></td> <td>Normally Open (NO)</td> </tr> <tr> <td></td> <td>Common (CO)</td> </tr> <tr> <td></td> <td>Normally Closed (NC)</td> </tr> <tr> <td>PE</td> <td>Schutzleiter (PE)</td> </tr> <tr> <td>N</td> <td>Neutralleiter (N)</td> </tr> <tr> <td>L</td> <td>Phase (L)</td> </tr> </table>		Normally Open (NO)		Common (CO)		Normally Closed (NC)	PE	Schutzleiter (PE)	N	Neutralleiter (N)	L	Phase (L)	<p>9. Connect the voltage supply cable to the power control board in accordance with the terminal diagram.</p>
	Normally Open (NO)												
	Common (CO)												
	Normally Closed (NC)												
PE	Schutzleiter (PE)												
N	Neutralleiter (N)												
L	Phase (L)												

Illustration	Description / explanation
	<p>10. Insert the power control board [9] back into the top cover [2] and fasten using the pan-head screw [35]. Tighten the voltage supply cable [H] while doing this and screw the components of the cable gland [5, 6, 7] in place.</p>
	<p>11. Fit the screw terminal [56]. Set the top cover [2] in place and fix it using the pan-head screws [3].</p>



## 7.2.1.2 Power control board DC

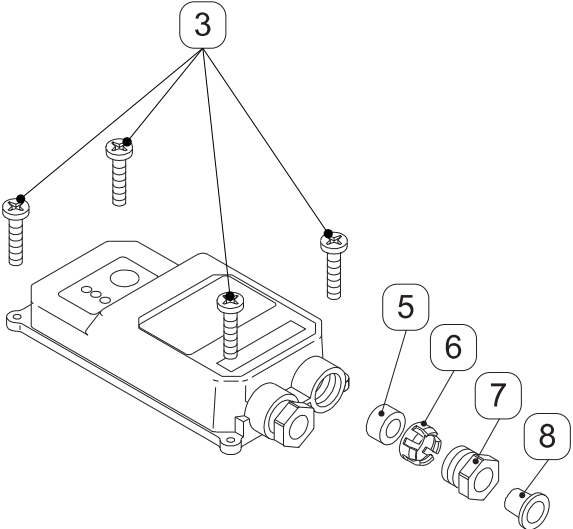
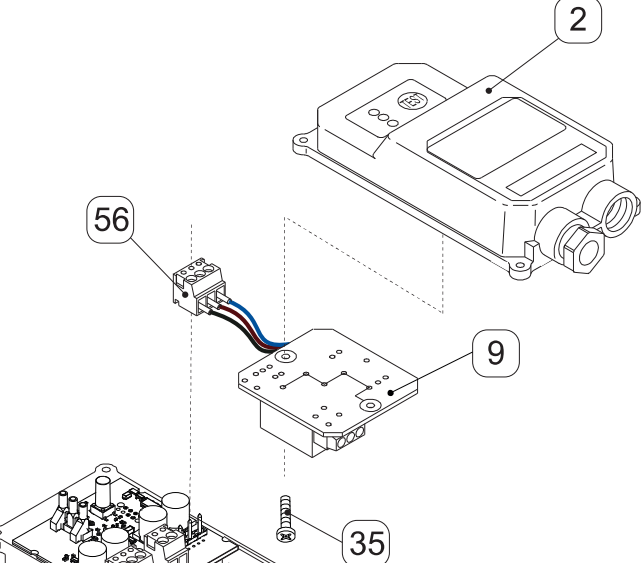
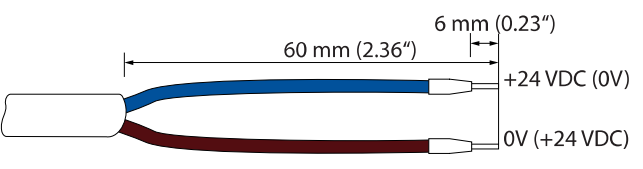
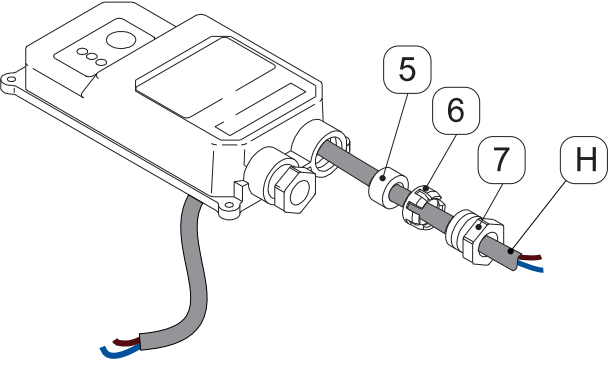
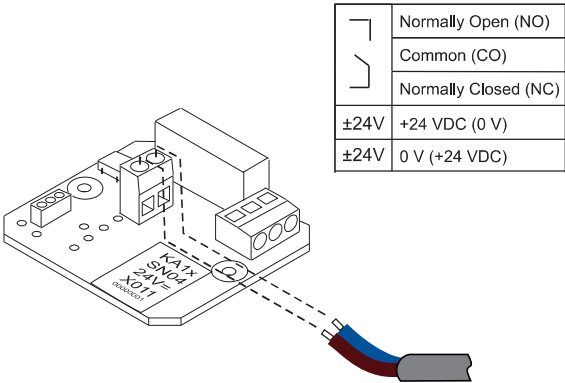
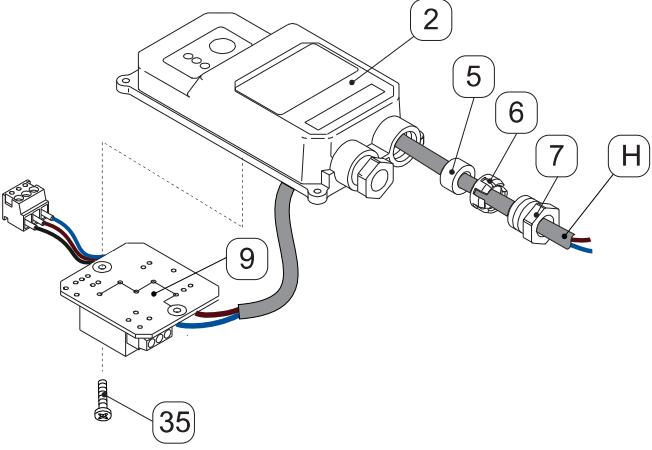
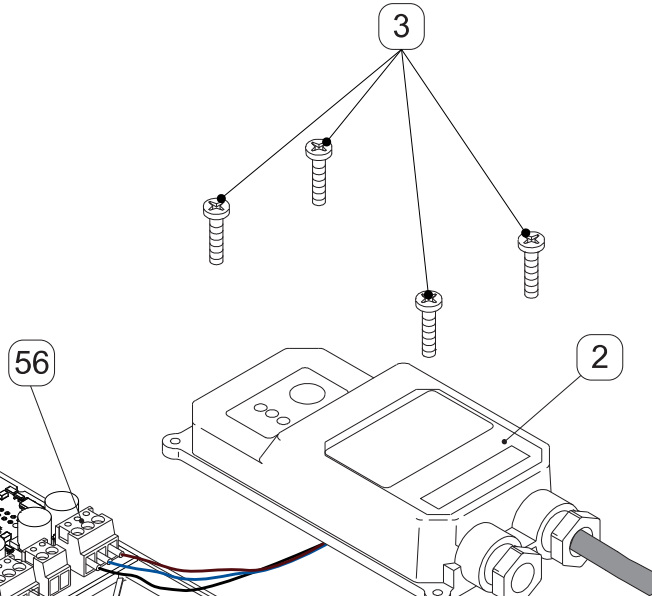
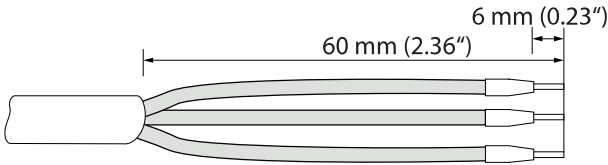

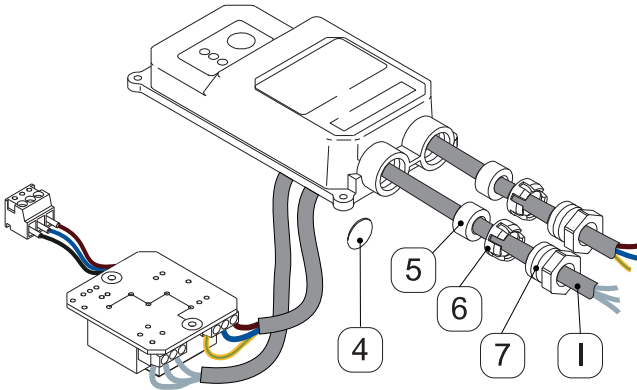
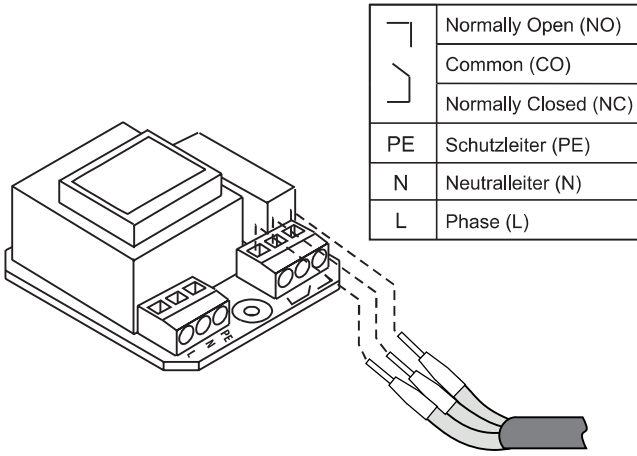









Illustration	Description / explanation
	<ol style="list-style-type: none"> <li>1. Loosen the 4 pan-head screw <b>[3]</b> in the top cover and unscrew the components of the cable gland <b>[5, 6, 7, 8]</b>.</li> </ol>
	<ol style="list-style-type: none"> <li>2. Raise the top cover <b>[2]</b> a little and pull the screw terminal <b>[56]</b> of the power control board up and off.</li> <li>3. Unscrew the pan-head screw <b>[35]</b> and take the power control board <b>[9]</b> out of the top cover <b>[2]</b>.</li> </ol>
	<ol style="list-style-type: none"> <li>4. Prepare the 2-wire cable of the voltage supply.</li> </ol>
	<ol style="list-style-type: none"> <li>5. Slide the components of the cable gland <b>[5, 6, 7]</b> over the cable for voltage supply <b>[H]</b> and insert the cable into the top cover.</li> </ol>

Illustration	Description / explanation										
 <table border="1" data-bbox="486 241 718 414"> <tr> <td></td> <td>Normally Open (NO)</td> </tr> <tr> <td></td> <td>Common (CO)</td> </tr> <tr> <td></td> <td>Normally Closed (NC)</td> </tr> <tr> <td>±24V</td> <td>+24 VDC (0 V)</td> </tr> <tr> <td>±24V</td> <td>0 V (+24 VDC)</td> </tr> </table>		Normally Open (NO)		Common (CO)		Normally Closed (NC)	±24V	+24 VDC (0 V)	±24V	0 V (+24 VDC)	<p>6. Connect the voltage supply cable to the power control board in accordance with the terminal diagram.</p>
	Normally Open (NO)										
	Common (CO)										
	Normally Closed (NC)										
±24V	+24 VDC (0 V)										
±24V	0 V (+24 VDC)										
	<p>7. Insert the power control board <b>[9]</b> back into the top cover <b>[2]</b> and fasten using the pan-head screw <b>[35]</b>. Tighten the voltage supply cable <b>[H]</b> while doing this and screw the components of the cable gland <b>[5, 6, 7]</b> in place.</p>										
	<p>8. Fit the screw terminal <b>[56]</b>, set the top cover <b>[2]</b> in place and fasten using the pan-head screw <b>[3]</b>.</p>										

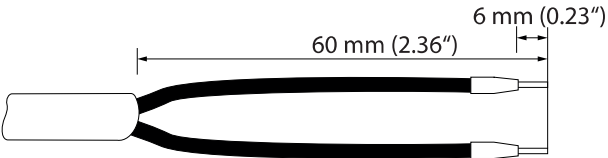

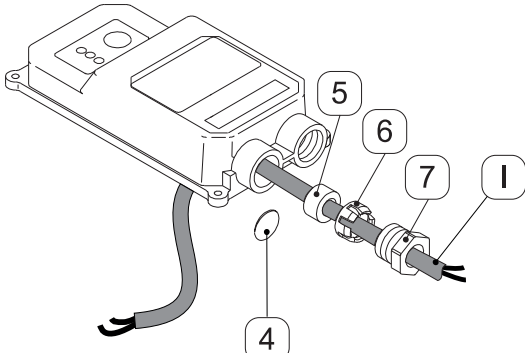
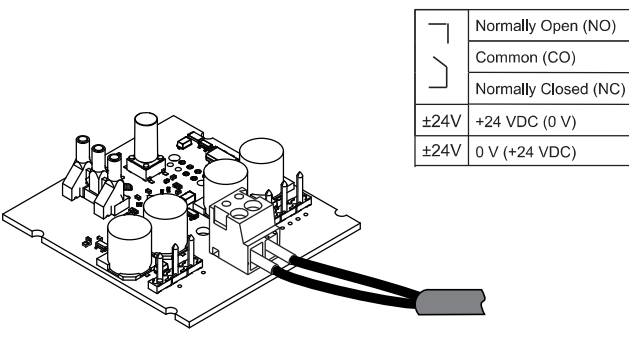









## 7.2.2 Connection of potential free contact

The **BEKOMAT®** has a potential-free contact on the power control board. A fault signal can be indicated at a remote maintenance centre through this.

Illustration	Description / explanation												
	<ol style="list-style-type: none"> <li>1. Prepare the 2/3-wire cable of the potential-free contact (depending on the application).</li> </ol> <p> If the external TEST button is to be connected in addition to the potential-free contact, a 4/5-wire cable must be used for the connection (depending on the application).</p>												
	<ol style="list-style-type: none"> <li>2. Take the dust protection pane [4] out.</li> <li>3. Slide the components of the cable gland [5, 6, 7] over the cable for potential-free contact [I] and insert the cable into the top cover.</li> </ol>												
 <table border="1" data-bbox="531 1126 802 1361"> <tbody> <tr> <td></td> <td>Normally Open (NO)</td> </tr> <tr> <td></td> <td>Common (CO)</td> </tr> <tr> <td></td> <td>Normally Closed (NC)</td> </tr> <tr> <td>PE</td> <td>Schutzleiter (PE)</td> </tr> <tr> <td>N</td> <td>Neutralleiter (N)</td> </tr> <tr> <td>L</td> <td>Phase (L)</td> </tr> </tbody> </table>		Normally Open (NO)		Common (CO)		Normally Closed (NC)	PE	Schutzleiter (PE)	N	Neutralleiter (N)	L	Phase (L)	<ol style="list-style-type: none"> <li>4. Connect the cable of the potential-free contact to the power control board in accordance with the terminal diagram.</li> </ol>
	Normally Open (NO)												
	Common (CO)												
	Normally Closed (NC)												
PE	Schutzleiter (PE)												
N	Neutralleiter (N)												
L	Phase (L)												




### 7.2.3 Connection of external TEST

The **BEKOMAT®** has an option for the connection of an external TEST button. This enables condensate to be discharged via remote control. If the external contact is closed, the solenoid valve opens like after pressing the TEST button on the top cover and the **BEKOMAT®** discharges condensate.

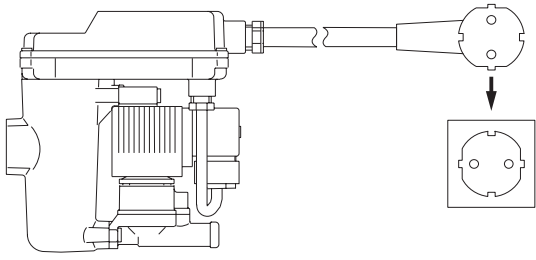
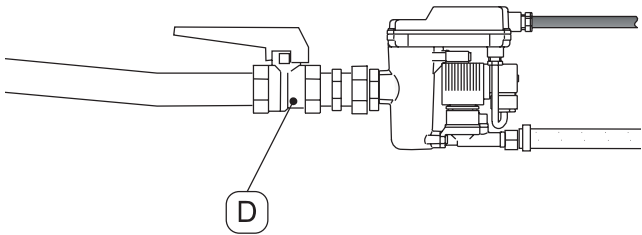
Illustration	Description / explanation										
	<p>1. Prepare the external TEST button cable.</p> <p> If the potential free contact is to be connected in addition to the external TEST button, a 4/5-wire cable must be used for the connection (depending on the application).</p>										
	<p>2. Take the dust protection pane [4] out of the left-hand cable gland.</p> <p>3. Slide the components of the cable gland [5, 6, 7] over the cable [I] and insert the cable into the top cover.</p>										
 <table border="1" data-bbox="542 1048 758 1205"> <tbody> <tr> <td></td> <td>Normally Open (NO)</td> </tr> <tr> <td></td> <td>Common (CO)</td> </tr> <tr> <td></td> <td>Normally Closed (NC)</td> </tr> <tr> <td>±24V</td> <td>+24 VDC (0 V)</td> </tr> <tr> <td>±24V</td> <td>0 V (+24 VDC)</td> </tr> </tbody> </table>		Normally Open (NO)		Common (CO)		Normally Closed (NC)	±24V	+24 VDC (0 V)	±24V	0 V (+24 VDC)	<p>4. Connect the cable of the external TEST button to the control PCB in accordance with the terminal diagram.</p>
	Normally Open (NO)										
	Common (CO)										
	Normally Closed (NC)										
±24V	+24 VDC (0 V)										
±24V	0 V (+24 VDC)										

## 8. Commissioning

### 8.1 Warning notices

<b>DANGER</b>	<b>Pressure build-up in the pipework!</b>
	<p>Death or serious personal injury can result through contact with fast or suddenly escaping compressed gas or through bursting system parts.</p>
	<ul style="list-style-type: none"> <li>• All work on the compressed gas system must be carried out in the depressurised state and with the compressed gas system secured against unintentional pressure build-up.</li> <li>• Set up a safety area around the working area during <b>all</b> assembly, installation, maintenance and repair work.</li> <li>• Before building up pressure in the pipework, check <b>all</b> pipe connections and tighten if necessary.</li> <li>• Slowly pressurise the system with pressure.</li> <li>• Avoid pressure blows and high differential pressures.</li> <li>• Assemble <b>all</b> pipelines without stress.</li> <li>• Install pipes tightly as feed and discharge lines.</li> </ul>
<b>DANGER</b>	<b>Electric voltage!</b>
	<p>There is a danger of death or serious injuries as well as malfunction and device failure following contact with components which are in contact with electric voltage.</p>
	<ul style="list-style-type: none"> <li>• Only carry out installation, maintenance and repair work on the product and accessories when they have been disconnected and secured against being switched back on again.</li> <li>• Set up a safety area around the working area during <b>all</b> installation, maintenance and repair work.</li> <li>• For installation of the device, adhere to <b>all</b> applicable regulations (e.g. VDE 0100 / IEC 60364/ ATEX).</li> <li>• Connect the protective conductor (earth connection) according to regulations.</li> </ul>
<b>WARNING</b>	<b>Insufficient qualification!</b>
	<p>Insufficient qualification of the personnel carrying out work on the product and accessories can lead to accidents, personal injury and damage to property as well as impair operation.</p>
	<ul style="list-style-type: none"> <li>• All work on the product and accessories may only be carried out by skilled technical personnel - compressed gas technology.</li> </ul>

## 8.2 Commissioning tasks

Illustration	Description / explanation
	<p>1. Supply the <b>BEKOMAT®</b> with voltage.</p>
	<p>2. Slowly charge the system section with pressure. To do this, slowly open the shut-off valve <b>[D]</b>.</p>

## 9. Operation

As soon as the **BEKOMAT®** is supplied with voltage, a self-test starts automatically, during which all internal components necessary for the proper functioning of the **BEKOMAT®** are checked.

If the self-test is positive, the **BEKOMAT®** goes into normal operation.

→ For acoustic signalling, the solenoid valve cycles twice.

If the self-test is negative, the **BEKOMAT®** goes into fail-safe operation.

→ For acoustic signalling, the solenoid valve cycles 20 times.

The LED signalling of the various operating states can be seen in the following table.

### 9.1 Operating states

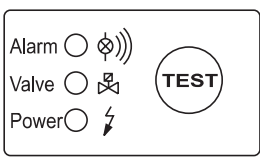
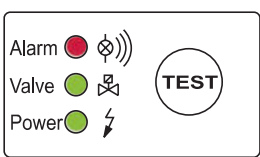





Illustration	Description / explanation
	<p><b>Disconnected</b></p> <ul style="list-style-type: none"> <li>All LEDs are off</li> </ul>
	<p><b>Switch on / power-on self-test</b></p> <ul style="list-style-type: none"> <li>All LEDs light up for 1 second</li> </ul>

Illustration	Description / explanation
	<p><b>Positive power-on self-test (repeat 2x)</b></p> <ul style="list-style-type: none"> <li>The red Alarm LED is off</li> <li>The green Valve LED lights up during the solenoid valve cycles</li> <li>The green Power LED is on</li> <li>The solenoid valve cycles</li> </ul> <p>→ <b>goes into normal operation</b></p>
	<p><b>Negative power-on self-test (repeat 20x)</b></p> <ul style="list-style-type: none"> <li>The red Alarm LED is on</li> <li>The green Valve LED lights up during the solenoid valve cycles</li> <li>The green Power LED is on</li> <li>The solenoid valve cycles</li> </ul> <p>→ <b>Goes to fail-safe operation (continuous loop)</b></p> <ul style="list-style-type: none"> <li>The solenoid valve cycles once per second</li> </ul>
	<p><b>Ready for operation (normal operating mode)</b></p> <ul style="list-style-type: none"> <li>The red Alarm LED is off</li> <li>The green Valve LED is off</li> <li>The green Power LED is on</li> </ul>
	<p><b>Discharge procedure (TEST button pressed briefly)</b></p> <ul style="list-style-type: none"> <li>The red Alarm LED is off</li> <li>The green Valve LED lights up during the discharge procedure</li> <li>The green Power LED is on</li> </ul>
	<p><b>Pre-alarm (TEST button pressed &gt;1 min and &lt;5 min)</b></p> <ul style="list-style-type: none"> <li>The red Alarm LED flashes</li> <li>The green Valve LED is on</li> <li>The green Power LED is on</li> </ul>
	<p><b>Alarm (TEST button pressed &gt;5 min)</b></p> <ul style="list-style-type: none"> <li>The red Alarm LED is on</li> <li>The green Valve LED is off</li> <li>The green Power LED is on</li> </ul>
	<p><b>Alarm mode (problem with condensate discharge)</b></p> <ul style="list-style-type: none"> <li>The red Alarm LED flashes</li> <li>The green Power LED lights up</li> <li>The green Valve LED lights up during the solenoid valve cycles</li> <li>The solenoid valve sets a cycle every 4 minutes</li> </ul> <p>→ Passes to normal mode with free condensate discharge</p>

For further information about fault indications during operation see **“15. Troubleshooting / FAQ” on Page 55.**

## 10. Maintenance

### 10.1 Warning notices

<b>DANGER</b>	<b>Pressure build-up in the pipework!</b>
	<p>Death or serious personal injury can result through contact with fast or suddenly escaping compressed gas or through bursting system parts.</p>
	<ul style="list-style-type: none"> <li>• All work on the compressed gas system must be carried out in the depressurised state and with the compressed gas system secured against unintentional pressure build-up.</li> <li>• Set up a safety area around the working area during all assembly, installation, maintenance and repair work.</li> <li>• Before building up pressure in the pipework, check all pipe connections and tighten if necessary.</li> <li>• Slowly pressurise the system with pressure.</li> <li>• Avoid pressure blows and high differential pressures.</li> <li>• Assemble all pipelines without stress.</li> <li>• Install pipes tightly as feed and discharge lines.</li> </ul>
<b>CAUTION</b>	<b>Inappropriate cleaning and use of the wrong cleaning media!</b>
	<p>Inappropriate cleaning and the use of the wrong cleaning media may result in minor injuries as well as damage to health and property.</p>
	<ul style="list-style-type: none"> <li>• Never clean the device with a dripping wet cloth.</li> <li>• Never use abrasive or aggressive cleaning agents or solvents which could damage the outer coating (e.g. markings, type plate, corrosion protection, etc.).</li> <li>• Never clean the device with hard or pointed implements.</li> <li>• Use an anti-static, damp cloth for cleaning the outside.</li> <li>• Immediately replace any product markings (pictograms, markings) that have become illegible.</li> </ul>
<b>WARNING</b>	<b>Insufficient qualification!</b>
	<p>Insufficient qualification of the personnel carrying out work on the product and accessories can lead to accidents, personal injury and damage to property as well as impair operation.</p>
	<ul style="list-style-type: none"> <li>• All work on the product and the accessories may only be carried out by skilled technical personnel - customer service.</li> </ul>
<b>CAUTION</b>	<b>Inappropriate maintenance!</b>
	<p>Inappropriate maintenance of the product and the accessories can lead to personal injury and damage to property as well as impair operation.</p>
	<ul style="list-style-type: none"> <li>• Always adhere to the maintenance schedule and the given maintenance intervals.</li> </ul>
<b>NOTE</b>	<b>Local hygiene regulations!</b>
	<p>In addition to the cleaning instructions listed, any local hygiene regulations which are in place must be heeded.</p>




## 10.2 Maintenance schedule

Maintenance	Interval
Wear parts exchange	Annually
Cleaning work	Annually
Visual inspection	Weekly
Leakage test	At the end of all assembly work and maintenance and servicing work on the product

## 10.3 Maintenance work

For maintenance work to be carried out, the following prerequisites must be fulfilled and the preparatory tasks must have been completed.

Prerequisites		
Tools	Material	Protective equipment
<ul style="list-style-type: none"> <li>Screwdrivers: Cross-head size 2.5 mm (0.09") Flat-blade size 2.5 mm (0.09")</li> <li>e.g. adjustable spanner</li> <li>Cleaning brush made of wire or soft plastic material with Ø max. = 1.5 mm (0.05") Ø max. = 2.5 mm (0.09")</li> </ul>	<ul style="list-style-type: none"> <li>Sealants</li> <li>Lubricant for greasing the O-rings</li> <li>Mild detergent</li> <li>Cotton cloth or disposable tissue</li> </ul>	<b>Always to be worn:</b> 

Preparatory tasks	
1.	Decommissioning and disassembly must have been completed.

### 10.3.1 Wear parts exchange

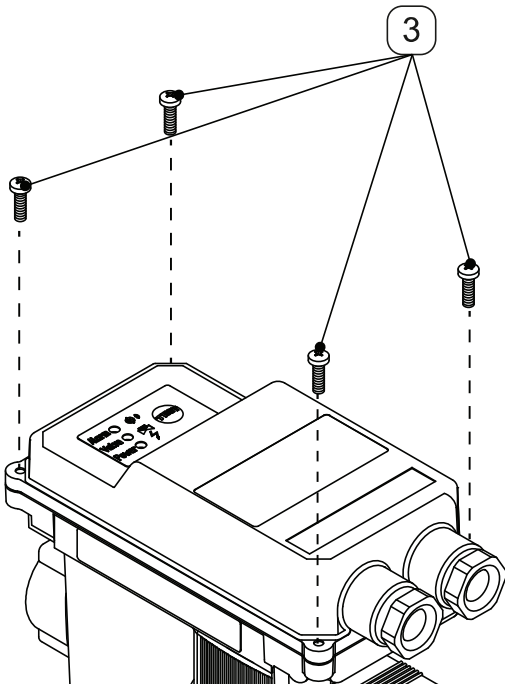
Illustration	Description / explanation
	<p>2. Loosen the 4 pan-head screws [3].</p>

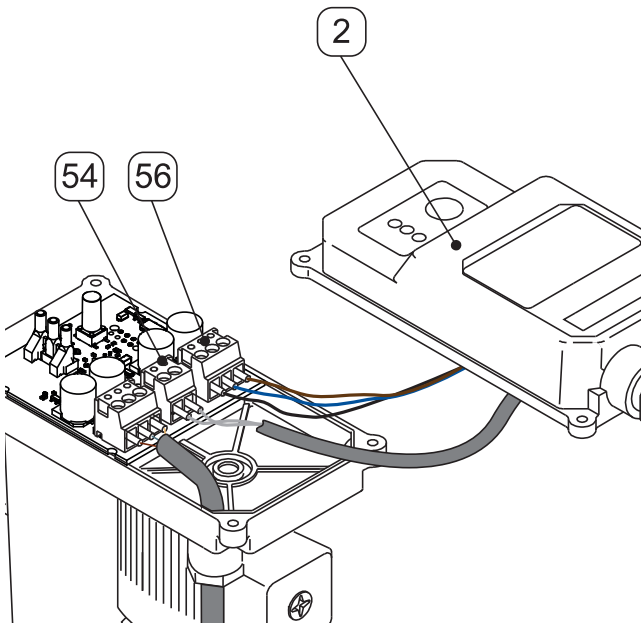
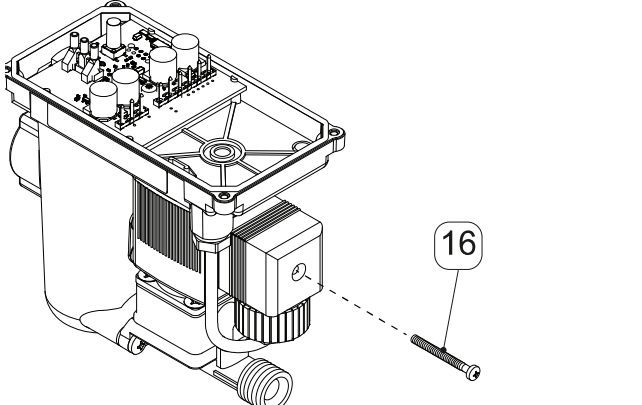
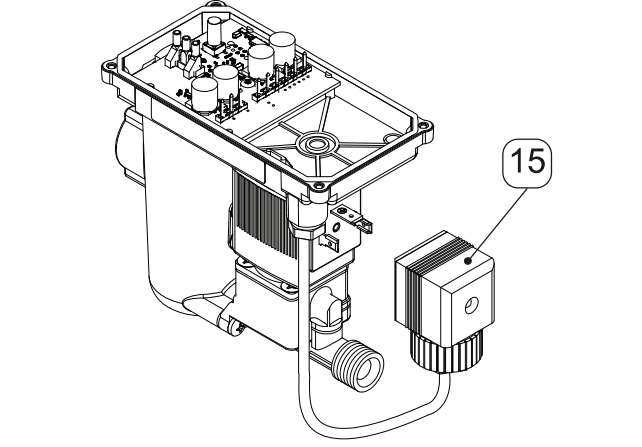
Illustration	Description / explanation
	<p>3. Raise the top cover [2] and lift the cable terminals [54, 56] off.</p>
	<p>4. Loosen the fixing screws of the solenoid valve connector [16].</p>
	<p>5. Pull the solenoid valve connector [15] off.</p>

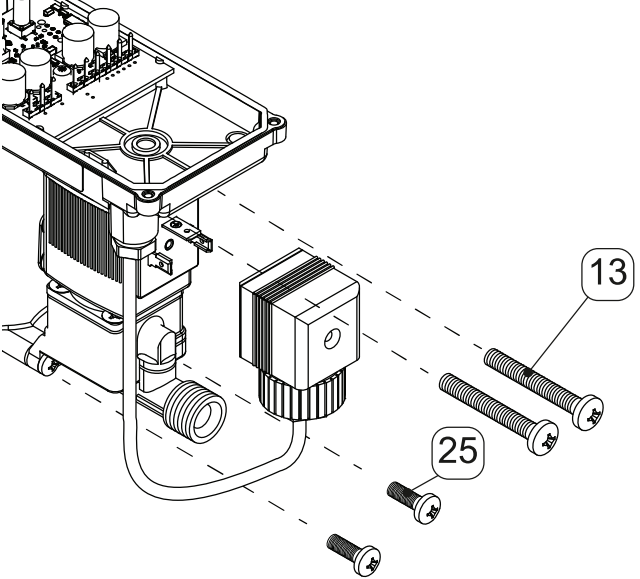
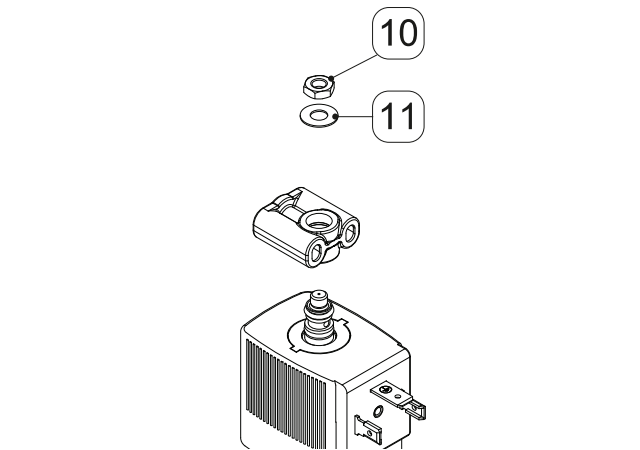
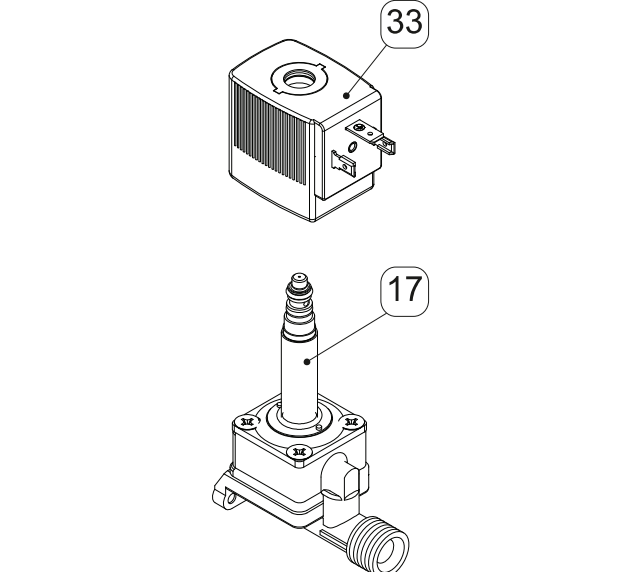
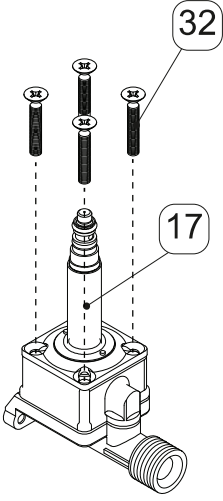
Illustration	Description / explanation
 <p>The illustration shows a top-down view of the solenoid valve assembly. A dashed line indicates the location of the solenoid valve on the main unit. Two screws, labeled 13 and 25, are shown being loosened from the valve. Screw 13 is a longer pan-head screw, and screw 25 is a shorter pan-head screw.</p>	<p>6. Loosen the pan-head screws <b>[13]</b> and <b>[25]</b> and remove the solenoid valve.</p>
 <p>The illustration shows a close-up of the solenoid valve assembly. A hexagon nut, labeled 10, and a washer, labeled 11, are shown being loosened from the valve. The valve is shown in a perspective view, with the nut and washer being removed from the top.</p>	<p>7. Loosen the hexagon nut <b>[10]</b> and remove together with the washer <b>[11]</b>.</p>
 <p>The illustration shows a close-up of the solenoid valve assembly. The solenoid coil, labeled 33, is shown being pulled up and off the core guide pipe, labeled 17. The valve is shown in a perspective view, with the coil being removed from the top.</p>	<p>8. Pull the solenoid coil <b>[33]</b> up and off the core guide pipe <b>[17]</b>.</p>

Illustration	Description / explanation
	<p>9. Loosen the countersunk head screws [32] and remove the core guide pipe [17].</p>


	<p>The intervals for wear part replacement and the necessary cleaning work are identical.  <b>Recommended interval:</b>                  Carry out cleaning work in the disassembled state at the same time as wear part replacement.</p>
---	---

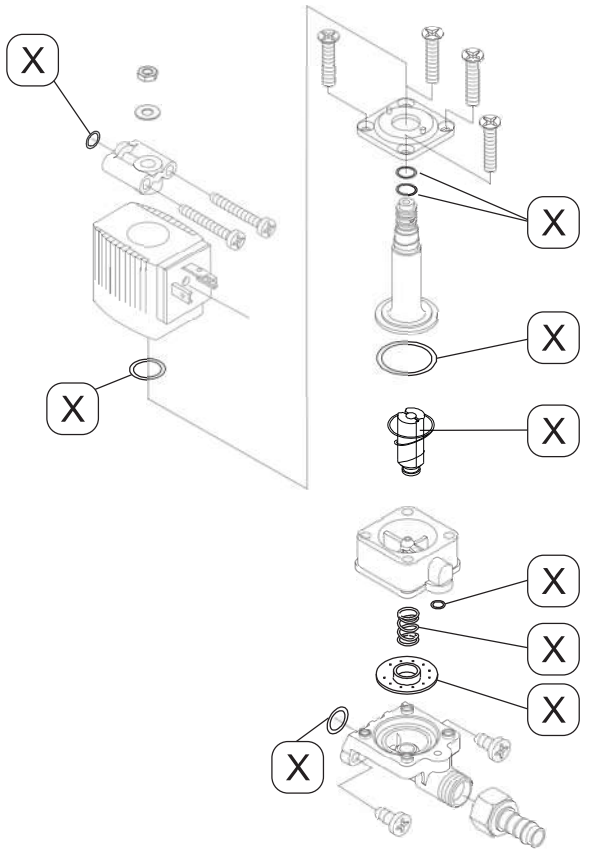
Illustration	Description / explanation
	<p>The components [X] are contained in the set of wear parts and must be replaced.</p> <p>10. Grease the O-rings in the set of wear parts.                  Use a lubricant suitable for this purpose.</p>

Illustration	Description / explanation
<p>The illustration shows a circular membrane component labeled [27] being lowered into a larger, square-shaped membrane seat labeled [24]. An arrow points from the membrane to the seat.</p>	<p>11. Place the membrane [27] in the membrane seat [24].</p>
<p>The illustration shows a coiled pressure spring labeled [28] being inserted into a square-shaped membrane cap labeled [21]. An arrow points from the spring into the cap.</p>	<p>12. Insert the pressure spring [28] in the membrane cap [21].</p>
<p>The illustration shows the membrane cap [21], which now contains the pressure spring, being placed onto the membrane seat [24]. An arrow points from the cap to the seat.</p>	<p>13. Place the membrane cap [21] with pressure spring [28] (not shown) onto the membrane seat. Make sure that the pressure spring is fitted in the centre of the membrane.</p>
<p>The illustration shows a multi-step assembly process. First, a valve core [19] is inserted into a core guide pipe [17]. Then, a flange [30] with four screws is placed over the top of the core guide pipe. Finally, the entire assembly is mounted onto the membrane cap [21]. Arrows indicate the downward sequence of parts.</p>	<p>14. Insert the valve core [19] into the core guide pipe [17]. Guide the flange [30] with countersunk head screws over the core guide pipe [17] and screw tightly on the membrane cap [21].</p>

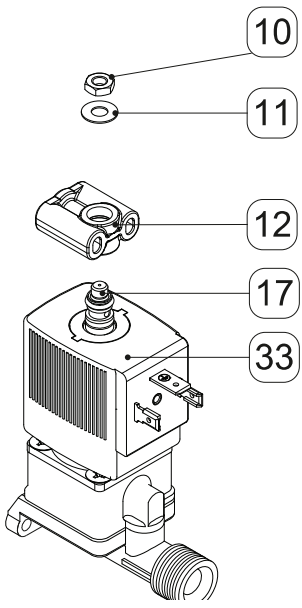
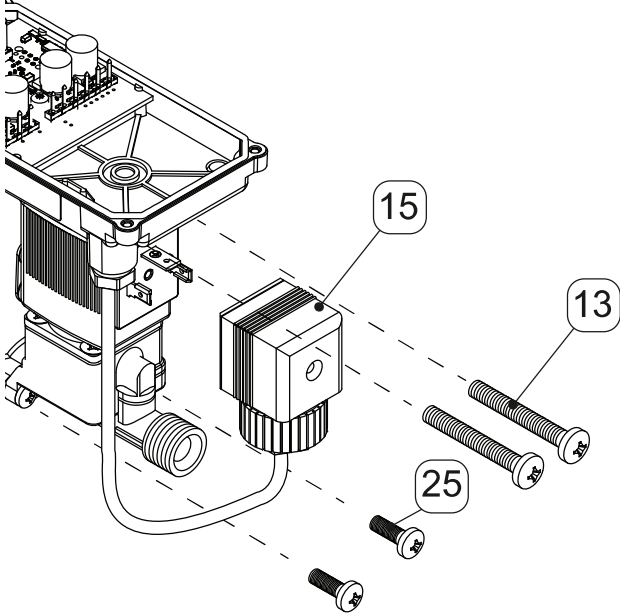
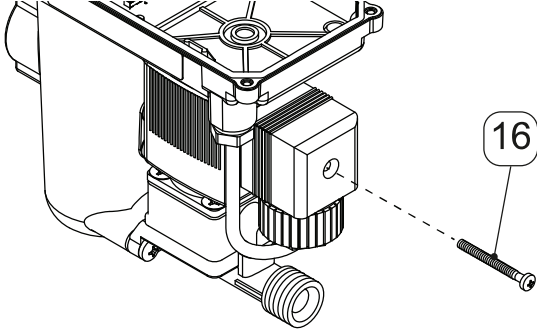
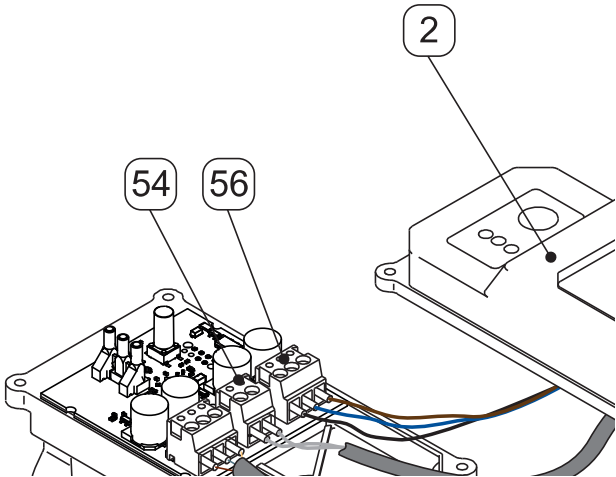
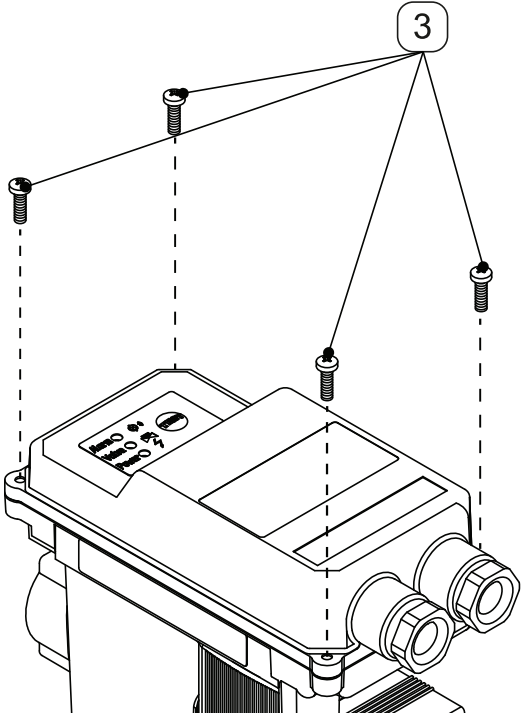
Illustration	Description / explanation
	<p>15. Insert the solenoid coil [33], the control-air cover [12] and the washer [11] onto the core guide pipe [17] and fasten the screw into place using the hexagon nut [10].</p>
	<p>16. Screw the solenoid valve to the housing again using the pan-head screws [13] and [25] and fit the solenoid valve connector [15].</p>
	<p>17. Screw the fixing screw of the solenoid valve connector [16] tight.</p>

Illustration	Description / explanation
	<p>18. Fit the cable terminals <b>[54, 56]</b> and the top cover <b>[2]</b>.</p>
	<p>19. Screw the 4 pan-head screws <b>[3]</b> tight.</p>

### 10.3.2 Cleaning work

Clean the **BEKOMAT®** using a damp (not dripping wet) cotton cloth or disposable wipe, a cleaning brush and a mild, conventional cleaning agent/soap.

Spray the cleaning agent on a clean cotton cloth or disposable wipe and wipe down the entire component. Then dry using a clean cloth or let it dry at room temperature.

Carry out the individual cleaning steps as follows:

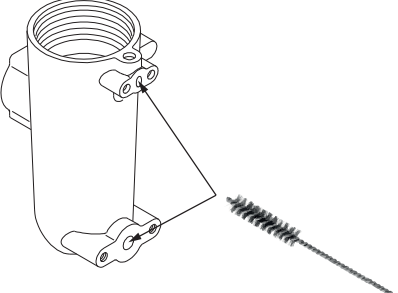
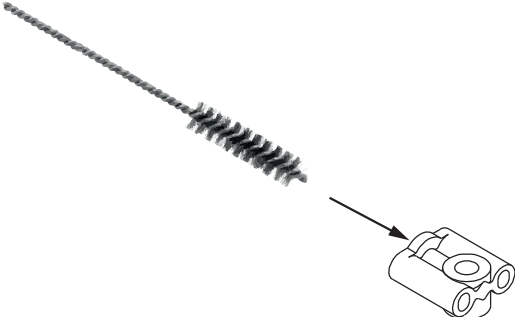
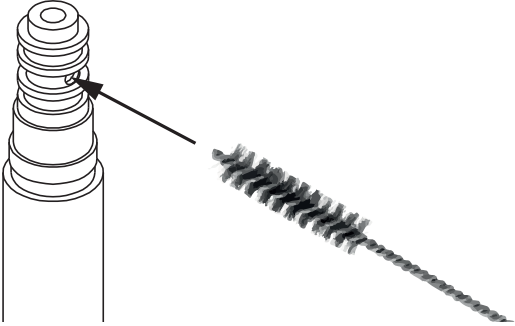
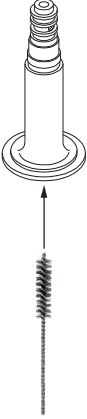


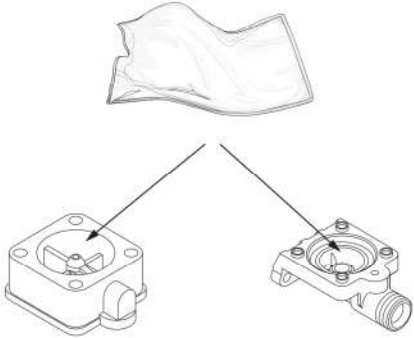
Illustration	Description / explanation
	<ol style="list-style-type: none"> <li>1. Clean the control-air bore and condensate discharge bore using a cleaning brush Ø max. = 2.5 mm (0.09").</li> </ol>
	<ol style="list-style-type: none"> <li>2. Clean the control-air cover using a cleaning brush Ø max. = 2.5 mm (0.09").</li> </ol>
	<ol style="list-style-type: none"> <li>3. Clean the upper opening on the core guide pipe using a cleaning brush Ø max. = 2.5 mm (0.09").</li> </ol>
	<ol style="list-style-type: none"> <li>4. Clean the core guide pipe from below using a cleaning brush or a clean cloth.</li> </ol>



Illustration	Description / explanation
	<p>5. Clean the membrane cap using a cleaning brush Ø max. = 1.5 mm (0.05").</p>
	<p>6. Clean the membrane seat using a cleaning brush Ø max. = 2.5 mm (0.09").</p>
	<p>7. Wipe the membrane seat and the membrane cap down using a clean cloth without cleaning agent.</p>

### 10.3.3 Visual inspection

During the visual inspection, check **all** components for mechanical damage and corrosion. Replace damaged components immediately.

### 10.3.4 Leakage test

The leakage test is a non-destructive test method and is used to prove leak tightness in vacuum and overpressure systems. The leakage test can be carried out in different ways. **BEKO TECHNOLOGIES** GmbH does not make a specific recommendation here. The company operating the compressed gas system is responsible for the selection and specification of the test method to be used, which should be executed in accordance with valid standards and regulations (e.g. DIN EN 1779).

## 11. Consumables, accessories and spare parts

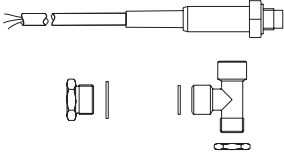
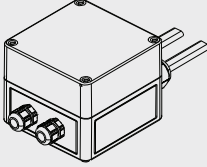
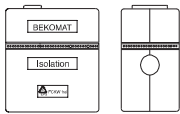
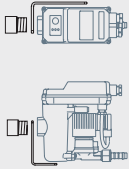
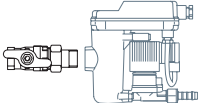
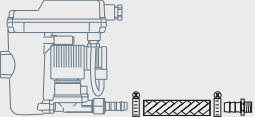
### 11.1 Order information

**BEKO TECHNOLOGIES** Service requires the following data for an inquiry or order:

- Serial number of the product (see type plate)
- Material number and designation of the accessory or spare part
- Required quantity of accessories or spare parts to be delivered

The contact data for the **BEKO TECHNOLOGIES** customer services responsible are listed in chapter **“1.1 Contact”** on **Page 4**.

## 11.2 Accessories

Illustration	Description / explanation & order reference
	<p><b>Thermostatically controlled heating system</b>            (200 ... 230 VAC) [BM12, BM12 CO]            (100 ... 115 VAC) [BM12, BM12 CO]            (24 VAC/VDC) [BM12, BM12 CO]</p>
	<p><b>Trace heater 230 VAC</b>            [BM12, BM12 CO, BM12 CO PN63]</p>
	<p><b>Insulation shell</b>            [BM12, BM12 CO, BM12 CO PN63]</p>
	<p><b>Mounting bracket for wall and floor installation</b>            [BM12, BM12 CO]</p>
	<p><b>Connection set</b>            [BM12, BM12 CO]</p>
	<p><b>Drain kit</b>            [BM12, BM12 CO]</p>

### 11.3 Spare parts

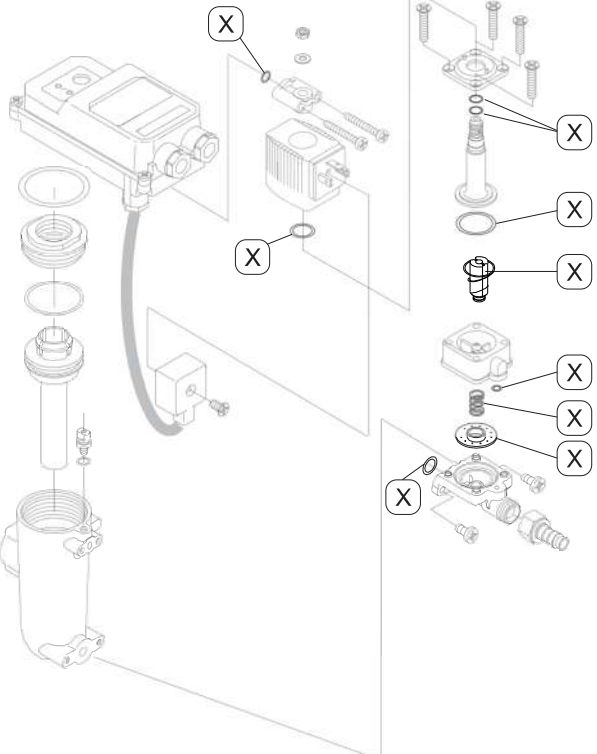
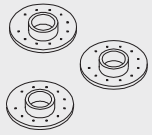
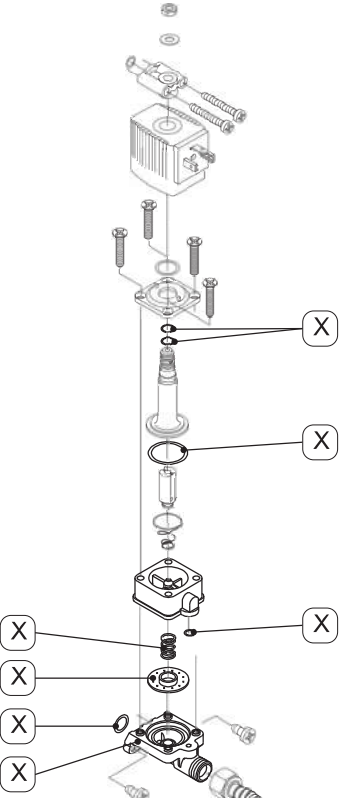
Illustration	Description / explanation & order reference
	<p><b>Set of wear parts</b>                      [BM12, BM12 CO]                      [BM12 CO PN63]</p>
	<p><b>Membranes, 3 pcs.</b>                      [BM12, BM12 CO]                      [BM12 CO PN63]</p>
	<p><b>Membrane seat</b>                      [BM12, BM12 CO]</p>

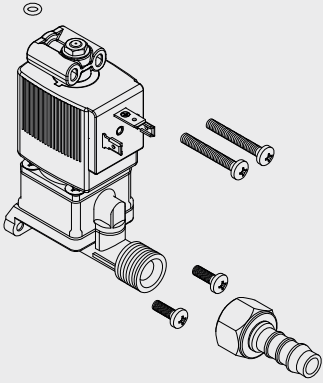
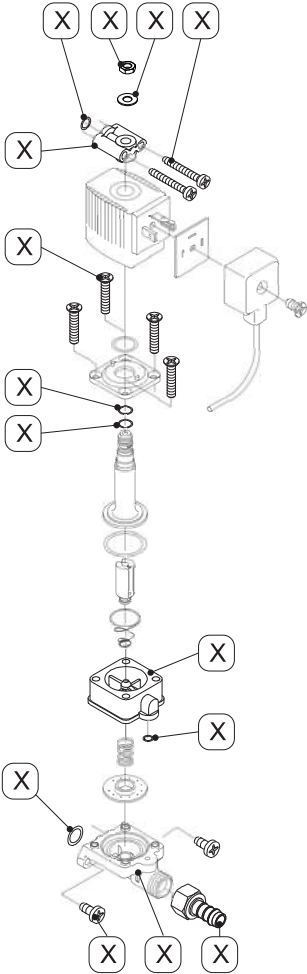
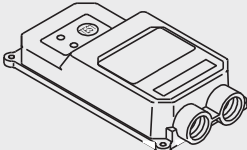
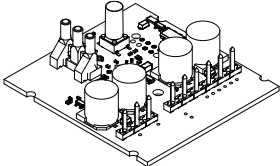
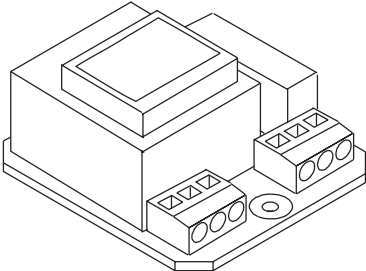
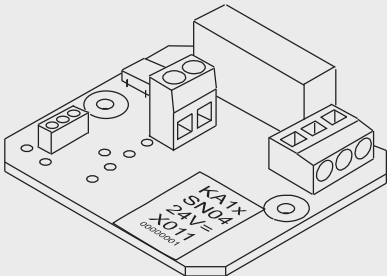



Illustration	Description / explanation & order reference
	<p><b>Valve unit, complete</b>                      [BM12]                      [BM12 CO]                      [BM12 CO PN63]</p>
	<p><b>Valve attachment components</b>                      [BM12]                      [BM12 CO]                      [BM12 CO PN63]</p>

Illustration	Description / explanation & order reference
	<p><b>Set of seals</b>  <span style="background-color: #cccccc; display: inline-block; width: 20px; height: 10px; vertical-align: middle;"></span> [BM12, BM12 CO]  <span style="background-color: #cccccc; display: inline-block; width: 20px; height: 10px; vertical-align: middle;"></span> [BM12 CO PN63]</p>
	<p><b>Housing</b>  [BM12]  [BM12 CO]  [BM12 CO PN63]</p>

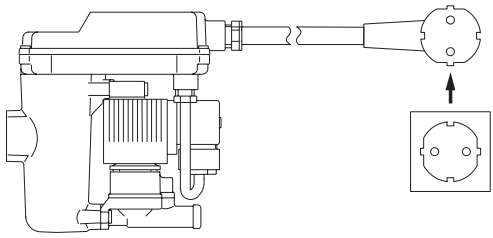

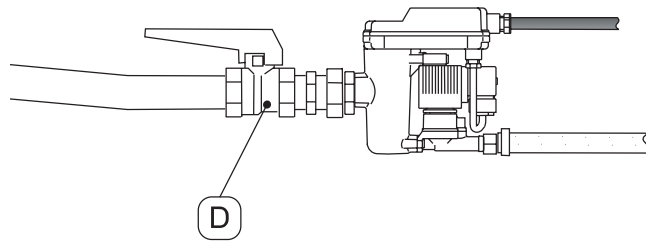
Illustration	Description / explanation & order reference
	<p><b>Top cover</b>  <span style="background-color: #cccccc; display: inline-block; width: 15px; height: 10px;"></span> [BM12, BM12 CO, BM12 CO PN63]</p>
	<p><b>Control PCB</b>  <span style="background-color: #cccccc; display: inline-block; width: 15px; height: 10px;"></span> [BM12, BM12 CO, BM12 CO PN63]</p>
	<p><b>Power control board 230 VAC</b>  <span style="background-color: #cccccc; display: inline-block; width: 15px; height: 10px;"></span> [BM12, BM12 CO, BM12 CO PN63]</p>
	<p><b>Power control board 200 VAC</b>  <span style="background-color: #cccccc; display: inline-block; width: 15px; height: 10px;"></span> [BM12, BM12 CO, BM12 CO PN63]</p>
	<p><b>Power control board 115 VAC</b>  <span style="background-color: #cccccc; display: inline-block; width: 15px; height: 10px;"></span> [BM12, BM12 CO, BM12 CO PN63]</p>
	<p><b>Power control board 100 VAC</b>  <span style="background-color: #cccccc; display: inline-block; width: 15px; height: 10px;"></span> [BM12, BM12 CO, BM12 CO PN63]</p>
	<p><b>Power control board 24 VAC</b>  <span style="background-color: #cccccc; display: inline-block; width: 15px; height: 10px;"></span> [BM12, BM12 CO, BM12 CO PN63]</p>
	<p><b>Power control board 24 VDC</b>  <span style="background-color: #cccccc; display: inline-block; width: 15px; height: 10px;"></span> [BM12, BM12 CO, BM12 CO PN63]</p>

## 12. Decommissioning

### 12.1 Warning notices

<b>DANGER</b>	<b>Pressure build-up in the pipework!</b>
	<p>Death or serious personal injury can result through contact with fast or suddenly escaping compressed gas or through bursting system parts.</p> <ul style="list-style-type: none"> <li>• All work on the compressed gas system must be carried out in the depressurised state and with the compressed gas system secured against unintentional pressure build-up.</li> <li>• Set up a safety area around the working area during all assembly, installation, maintenance and repair work.</li> <li>• Before building up pressure in the pipework, check all pipe connections and tighten if necessary.</li> <li>• Slowly pressurise the system with pressure.</li> <li>• Avoid pressure blows and high differential pressures.</li> <li>• Assemble all pipelines without stress.</li> <li>• Install pipes tightly as feed and discharge lines.</li> </ul>
<b>DANGER</b>	<b>Electric voltage!</b>
	<p>There is a danger of death or serious injuries as well as malfunction and device failure following contact with components which are in contact with electric voltage.</p> <ul style="list-style-type: none"> <li>• Only carry out installation, maintenance and repair work on the product and accessories when they have been disconnected and secured against being switched back on again.</li> <li>• Set up a safety area around the working area during all installation, maintenance and repair work.</li> <li>• For installation of the device, adhere to all applicable regulations (e.g. VDE 0100 / IEC 60364/ ATEX).</li> <li>• Connect the protective conductor (earth connection) according to regulations.</li> </ul>
<b>WARNING</b>	<b>Insufficient qualification!</b>
	<p>Insufficient qualification of the personnel carrying out work on the product and accessories can lead to accidents, personal injury and damage to property as well as impair operation.</p> <ul style="list-style-type: none"> <li>• All work on the product and accessories may only be carried out by skilled technical personnel - compressed gas technology.</li> </ul>


### 12.2 Decommissioning work

Illustration	Description / explanation
	<ol style="list-style-type: none"> <li>1. Disconnect the <b>BEKOMAT®</b> from the voltage supply and disconnect the potential-free contact completely.</li> </ol> <div style="display: flex; align-items: center;">  <p>Without voltage supply being applied, an error message / fault is outputted via the potential-free contact and the external TEST button is without function.</p> </div>
	<ol style="list-style-type: none"> <li>2. Close the shut-off valve [D].</li> </ol>

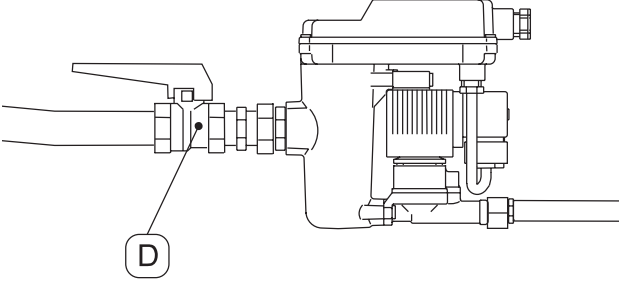
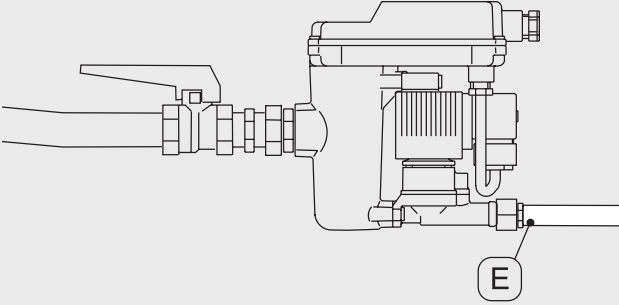


## 13. Disassembly

For dismantling work to be carried out, the following prerequisites must be fulfilled and the preparatory tasks must have been completed.



Prerequisites		
Tools	Material	Protective equipment
<ul style="list-style-type: none"> <li>e.g. adjustable spanner</li> </ul>		<b>Always to be worn:</b> 

Preparatory tasks	
1.	Depressurise the compressed gas system or the respective system section and secure it against unintentional pressure build-up.
2.	Decommissioning has been completed.

Illustration	Description / explanation
	3. Close and disassemble the feed line [D].
	4. Disassemble the discharge line [E].

## 14. Disposal

### 14.1 Warning notices

<b>NOTE</b>	<b>Inappropriate disposal!</b>
	<p>Inappropriate disposal of parts and components, operating and auxiliary materials as well as cleaning media can cause environmental damage.</p>
	<ul style="list-style-type: none"> <li>• Dispose of all components and parts, operating and auxiliary materials as well as cleaning media professionally and in accordance with regional legal provisions, regulations and requirements.</li> <li>• In case of uncertainties regarding disposal, always consult a regional waste management company.</li> </ul>
<b>INFORMATION</b>	<b>Disposal of electrical and electronic equipment</b>
	<p>Electrical and electronic equipment (EEE) contains materials, components and substances which can be dangerous and harmful for human health and the environment if the waste from electrical and electronic equipment (WEEE) is not disposed of properly.</p>
	<p>Electrical and electronic equipment are marked by the crossed out rubbish bin. The crossed out rubbish bin symbolises that electrical and electronic equipment must be collected separately and must not be disposed of together with unsorted domestic waste.</p>
	<p>For this purpose, all communities have set up collecting systems where waste from electrical or electronic equipment can be handed in free of charge to recycling stations or other collecting points or can be collected directly from households. Contact the technical office of your local authority for further information.</p>
	<p>Users of electrical and electronic appliances must not dispose of electrical and electronic appliances together with domestic waste. Users must use the communal collecting systems to reduce the environmental impact of the disposal of electrical and electronic appliances and improve the possibilities for recycling recycling and reusing used electrical and electronic appliances.</p>

## 14.2 Disposal work

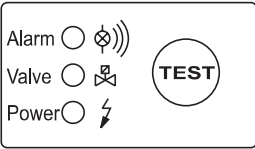
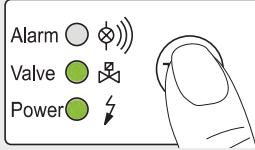
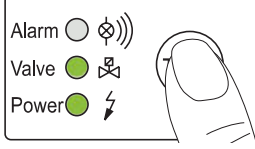
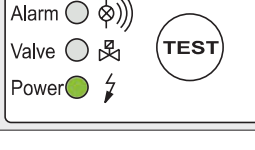
At the end of its useful life, dispose of the product properly e.g. through a specialist company. Do not dispose of electrical and electronic components via municipal waste disposal companies or household waste. Materials such as e.g. glass, plastic are recyclable to a major extent and can be used again.

Fulfil the following prerequisites before disposal:

Prerequisites	
1.	The <b>BEKOMAT®</b> has been decommissioned and disassembled.
2.	The <b>BEKOMAT®</b> has been cleaned and freed of any condensate residue.






Operating material	EU waste code
Adsorption and filter materials, cleaning wipes and protective clothing - soiled by oils or other hazardous substances	15 02 02
Adsorption and filter materials, cleaning wipes and protective clothing - with the exception of those classified by 15 02 02	15 02 03
Packaging - paper and cardboard	15 01 01
Packaging - plastic material	15 01 02
Electric and electronic devices with the exception of those covered by 20 01 21, 20 01 23 and 20 01 35	20 01 36

## 15. Troubleshooting / FAQ

Illustration	Description / explanation	Troubleshooting
	All LEDs off	<ul style="list-style-type: none"> <li>Read the operating voltage off on the type plate and check it</li> <li>Check whether voltage is applied to the terminals of the power control board (PE, L, N)</li> <li>Check the plug-type connection of the screw terminal on the control PCB</li> </ul>
	TEST button has been pressed but no condensate is being drained	<ul style="list-style-type: none"> <li>Check feed and discharge lines</li> <li>Replace wear parts</li> <li>Check whether the valve clogging can be heard, to do this press the TEST button several times</li> <li>Check the plug-type connection of the connection terminal on the control PCB</li> </ul>
	Condensate is only drained when the TEST button is pressed	<ul style="list-style-type: none"> <li>Install feed line at a gradient &gt;3%</li> <li>Mount venting line</li> <li>Clean sensor tube</li> <li>Check whether the necessary minimum pressure has been reached, if not: → install <b>BEKOMAT®</b> vacuum discharge</li> </ul>
	Device constantly blows off air	<ul style="list-style-type: none"> <li>Clean entire valve unit</li> <li>Replace wear parts</li> <li>Clean sensor tube</li> </ul>

## 16. Appendices

### 16.1 Approval certificates and declarations of conformity

Symbol	Description / explanation
	<p><b>CE marking</b> The CE marking indicates that a product fulfils all the EU directives applicable for this product and that basic safety and health requirements were met during manufacturing of the product. The product may be sold on the European market.</p>
	<p><b>FCC marking</b> The FCC marking indicates that a product fulfils the requirements of the Federal Communications Commission (FCC) and that basic safety and health requirements were met during manufacturing of the product. The product may be sold on the US American market.</p>
	<p><b>cTÜVus marking</b> The cTÜVus marking indicates that a product fulfils the requirements of TÜV Rheinland for the Canadian and US American market and that basic safety and health requirements were met during manufacturing of the product. The product may be sold on the Canadian and US American market.</p>
	<p><b>EAC marking</b> The EAC marking indicates that a product fulfils all the Eurasian directives applicable for this product and that basic safety and health requirements were met during manufacturing of the product. The product may be sold on the Eurasian market.</p>
	<p><b>WEEE marking</b> The crossed out rubbish bin marks an electrical or electronic product that must not be disposed of with domestic waste at the end of its service life. Free collecting points for used electrical equipment as well as further acceptance points for reuse of the products are available for them to be returned. Addresses can be obtained from the local authorities.</p>

BEKO TECHNOLOGIES GMBH  
Im Taubental 7  
41468 Neuss

GERMANY

Tel: +49 2131 988-0  
www.beko-technologies.com



## EU Declaration of Conformity

We hereby declare that the products named below comply with the stipulations of the relevant directives and technical standards. This declaration only refers to products in the condition in which they have been placed into circulation. Parts which have not been installed by the manufacturer and/or modifications which have been implemented subsequently remain unconsidered.

Product designation:	Condensate drain
Type:	BEKOMAT® 12..., 13..., 14..., 16...
Supply voltage versions:	24 VDC, 24 VAC, 48 VAC, 100 VAC, 115 VAC, 200 VAC, 230 VAC
Maximum operating pressure:	16 bar (g) (Standard) 25 bar (g) (only BEKOMAT® 13 ... PN25, 14 ... PN25) 40 bar (g) (only BEKOMAT® 13 ... PN40) 50 bar (g) (only BEKOMAT® 13 ... PN50) 63 bar (g) (only BEKOMAT® 12 ... PN63) 17,2 bar (g) (only BEKOMAT® 12, 13, 14 ... CRN)
Product description and function:	Condensate drain for the electronically level-controlled discharge of condensate in the compressed-air system.

### Low Voltage Directive 2014/35/EU

Applied harmonised standards: EN 61010-1: 2010  
Chapter 1-14, 16, 17, appendix A-D, F, G, I-L, ZA

The devices with working voltage of 24 VDC, 24 VAC and 48 VAC are not in the scope of the Low-Voltage Directive.

### EMC Directive 2014/30/EU

Applied harmonised standards: EN 55011: 2009, group 1, class B  
EN 61326-1:2013

### Pressure Equipment Directive 2014/68/EU (only BEKOMAT 16)

Applied conformity assessment procedure: Module A  
Category: I  
Description of the pressure device: Container device for fluids of Group 2

### RoHS II Directive 2011/65/EU

The products meet the requirements laid down in European Directive 2011/65/EU concerning the restriction of the use of certain hazardous substances in electrical and electronic devices.

The manufacturer shall have sole responsibility for issuing this declaration of conformity.

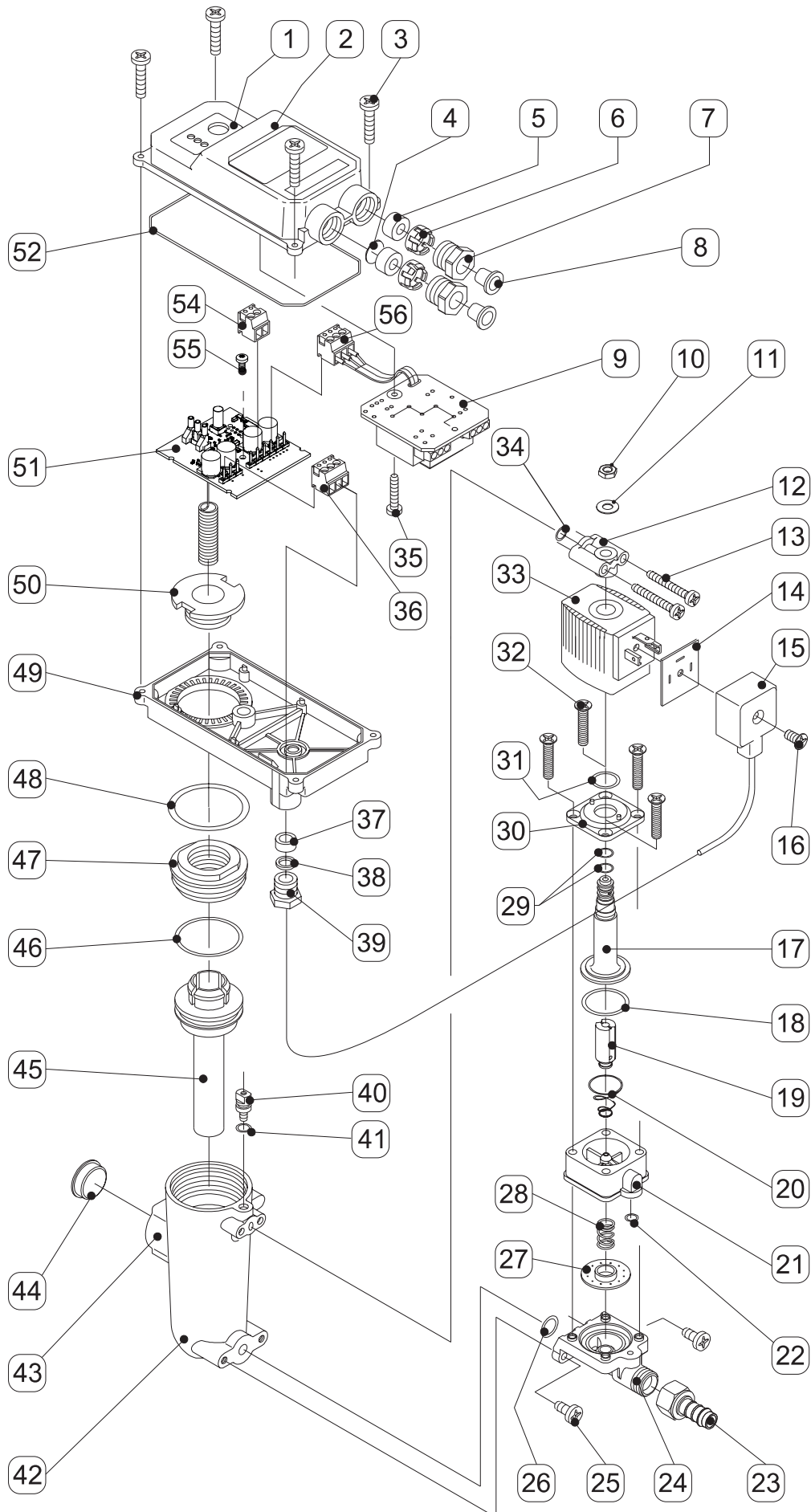
Neuss, 13/10/2017

Signed for and on behalf of:

BEKO TECHNOLOGIES GMBH

i.V. Christian Riedel  
Head of International Quality Management

### 16.2 Exploded view BM12, BM12 CO

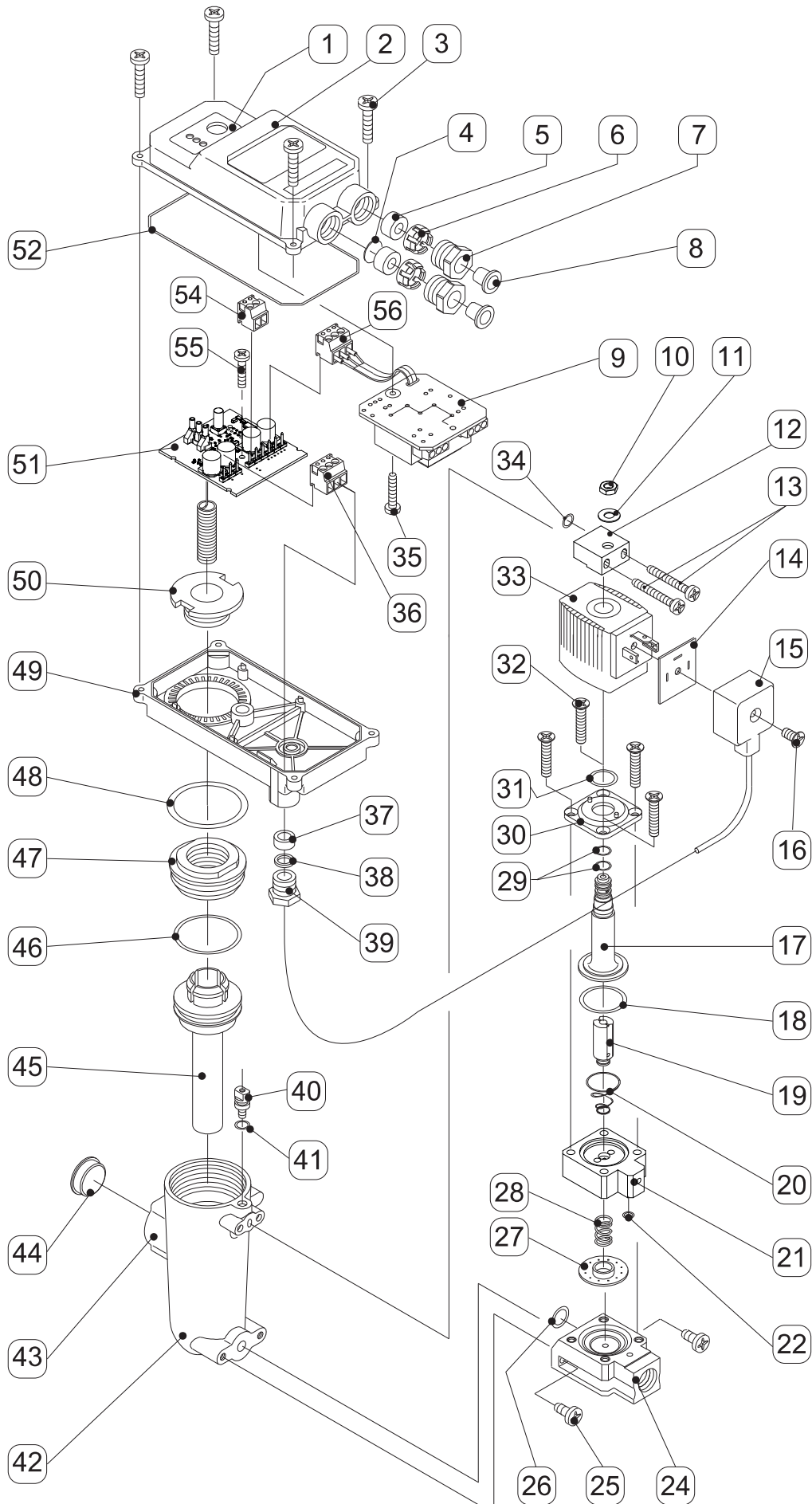


Pos. no.	Description / explanation
[1]	Operating label with TEST button
[2]	Top cover
[3]	Pan-head screw M3 x 10
[4]	Dust protection pane
[5]	Sealing ring for PG9
[6]	Clamp cage for PG9
[7]	Pressure screw for PG9
[8]	Locking element
[9]	Power control board
[10]	Hexagon nut M5
[11]	Washer
[12]	Control air cover
[13]	Pan-head screw M4 x 30
[14]	Seal for solenoid valve connector
[15]	Solenoid valve connector
[16]	Fixing screw for solenoid valve connector
[17]	Core guide pipe
[18]	Oval ring 21.8 x 1.5 x 2.5 mm
[19]	Valve core
[20]	Conical spring
[21]	Membrane cap
[22]	O-ring 5.5 x 1.5 mm
[23]	Hose connection Ø10 mm
[24]	Membrane seat
[25]	Pan-head screw M4 x 12
[26]	O-ring 9.25 x 1.78 mm
[27]	Membrane
[28]	Pressure spring for membrane

Pos. no.	Description / explanation
[29]	O-ring 5 x 1.5 mm (top) O-ring 6 x 1.5 mm (bottom)
[30]	Flange
[31]	O-ring 11.1 x 1.78 mm
[32]	Countersunk head screw M4 x 25
[33]	Solenoid coil
[34]	O-ring 5.5 x 1.5 mm
[35]	Pan-head screw M3 x 6
[36]	Cable terminal for solenoid valve
[37]	Sealing ring for PG7
[38]	Pressure ring for PG7
[39]	Pressure screw for PG7
[40]	Earthing screw
[41]	O-ring 4 x 1.5 mm
[42]	Housing
[43]	Condensate inlet
[44]	Dust cap R1/2
[45]	Sensor tube
[46]	O-ring 31.42 x 2.62 mm
[47]	Fixing screw
[48]	O-ring 34.59 x 2.62 mm
[49]	Bottom cover
[50]	Cover mounting element
[51]	Control PCB
[52]	Cord packing 2 x 315 mm
[53]	-
[54]	Cable terminal for external test button
[55]	Pan-head screw M3 x 6
[56]	Cable terminal for voltage supply



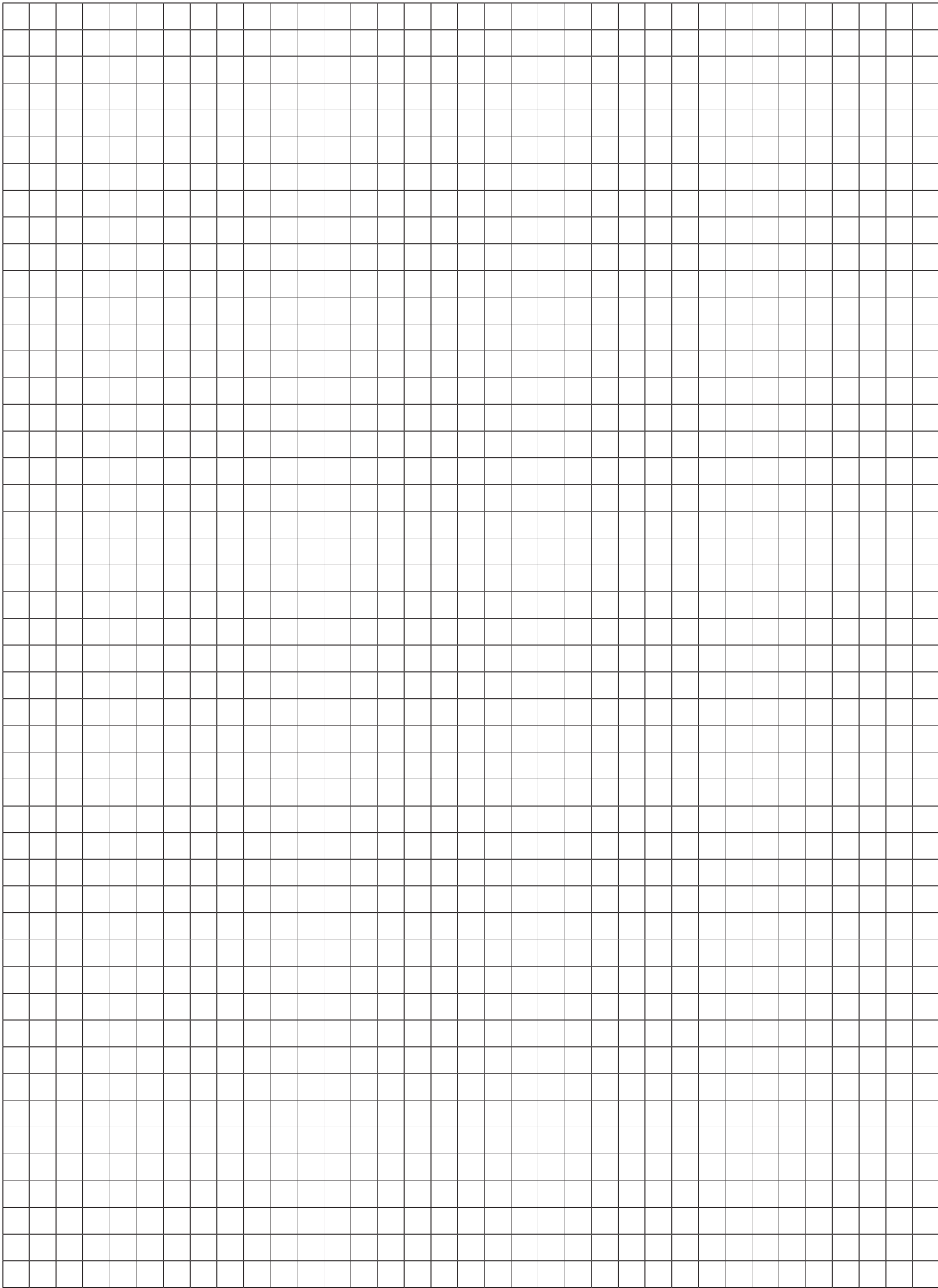
### 16.3 Exploded view of BM12 CO PN63

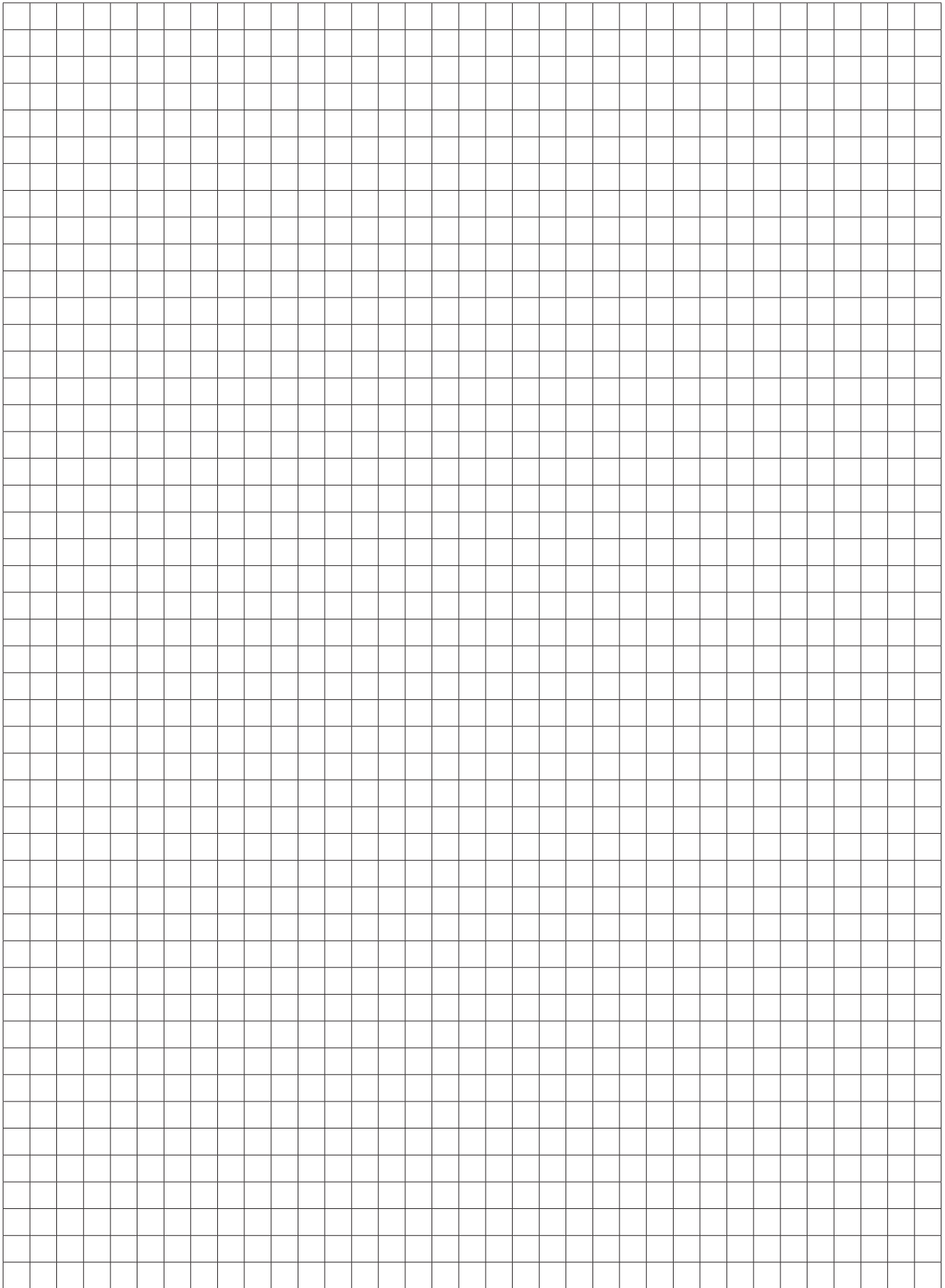




Pos. no.	Description / explanation
[1]	Operating label with TEST button
[2]	Top cover
[3]	Pan-head screw M3 x 10
[4]	Dust protection pane
[5]	Sealing ring for PG9
[6]	Clamp cage for PG9
[7]	Pressure screw for PG9
[8]	Locking element
[9]	Power control board
[10]	Hexagon nut M5
[11]	Washer
[12]	Control air cover
[13]	Pan-head screw M4 x 30
[14]	Seal for solenoid valve connector
[15]	Solenoid valve connector
[16]	Fixing screw for solenoid valve connector
[17]	Core guide pipe
[18]	Oval ring 21.8 x 1.5 x 2.5 mm
[19]	Valve core
[20]	Conical spring
[21]	Membrane cap
[22]	O-ring 5.5 x 1.5 mm
[23]	-
[24]	Membrane seat
[25]	Pan-head screw M4 x 12
[26]	O-ring 9.25 x 1.78 mm
[27]	Membrane
[28]	Pressure spring for membrane

Pos. no.	Description / explanation
[29]	O-ring 5 x 1.5 mm (top) O-ring 6 x 1.5 mm (bottom)
[30]	Flange
[31]	O-ring 11.1 x 1.78 mm
[32]	Countersunk head screw M4 x 25
[33]	Solenoid coil
[34]	O-ring 5.5 x 1.5 mm
[35]	Pan-head screw M3 x 6
[36]	Cable terminal for solenoid valve
[37]	Sealing ring for PG7
[38]	Pressure ring for PG7
[39]	Pressure screw for PG7
[40]	Earthing screw
[41]	O-ring 4 x 1.5 mm
[42]	Housing
[43]	Condensate inlet
[44]	Dust cap R1/2
[45]	Sensor tube
[46]	O-ring 31.42 x 2.62 mm
[47]	Fixing screw
[48]	O-ring 34.59 x 2.62 mm
[49]	Bottom cover
[50]	Cover mounting element
[51]	Control PCB
[52]	Cord packing 2 x 315 mm
[53]	-
[54]	Cable terminal for external test button
[55]	Pan-head screw M3 x 6
[56]	Cable terminal for voltage supply





**BEKO TECHNOLOGIES GmbH**

Im Taubental 7  
 D - 41468 Neuss  
 Tel. +49 2131 988 0  
 Fax +49 2131 988 900  
 info@beko-technologies.com  
 service-eu@beko-technologies.com

**DE****BEKO TECHNOLOGIES LTD.**

Unit 11-12 Moons Park  
 Burnt Meadow Road  
 North Moons Moat  
 Redditch, Worcs, B98 9PA  
 Tel. +44 1527 575 778  
 info@beko-technologies.co.uk

**GB****BEKO TECHNOLOGIES S.à.r.l.**

Zone Industrielle  
 1 Rue des Frères Rémy  
 F - 57200 Sarreguemines  
 Tel. +33 387 283 800  
 info@beko-technologies.fr  
 service@beko-technologies.fr

**FR****BEKO TECHNOLOGIES B.V.**

Veenen 12  
 NL - 4703 RB Roosendaal  
 Tel. +31 165 320 300  
 benelux@beko-technologies.com  
 service-bnl@beko-technologies.com

**NL****BEKO TECHNOLOGIES (Shanghai) Co. Ltd.**

Rm. 606 Tomson Commercial Building  
 710 Dongfang Rd.  
 Pudong Shanghai China  
 P.C. 200122  
 Tel. +86 21 508 158 85  
 info.cn@beko-technologies.cn  
 service1@beko.cn

**CN****BEKO TECHNOLOGIES s.r.o.**

Na Pankraci 58  
 CZ - 140 00 Praha 4  
 Tel. +420 24 14 14 717 /  
 +420 24 14 09 333  
 info@beko-technologies.cz

**CZ****BEKO Tecnológica España S.L.**

Torruella i Urpina 37-42, nave 6  
 E - 08758 Cervelló  
 Tel. +34 93 632 76 68  
 Mobil +34 610 780 639  
 info.es@beko-technologies.es

**ES****BEKO TECHNOLOGIES LIMITED**

Unit 1010 Miramar Tower  
 132 Nathan Rd.  
 Tsim Sha Tsui Kowloon Hong Kong  
 Tel. +852 5578 6681 (Hong Kong)  
 +86 147 1537 0081 (China)  
 tim.chan@beko-technologies.com

**HK****BEKO TECHNOLOGIES INDIA Pvt. Ltd.**

Plot No.43/1 CIEEP Gandhi Nagar  
 Balanagar Hyderabad  
 IN - 500 037  
 Tel. +91 40 23080275 /  
 +91 40 23081107  
 Madhusudan.Masur@bekoindia.com  
 service@bekoindia.com

**IN****BEKO TECHNOLOGIES S.r.l.**

Via Peano 86/88  
 I - 10040 Leini (TO)  
 Tel. +39 011 4500 576  
 Fax +39 0114 500 578  
 info.it@beko-technologies.com  
 service.it@beko-technologies.com

**IT****BEKO TECHNOLOGIES K.K.**

KEIHIN THINK Building 8 Floor  
 1-1 Minamiwatarida-machi  
 Kawasaki-ku, Kawasaki-shi  
 JP - 210-0855  
 Tel. +81 44 328 76 01  
 info@beko-technologies.jp

**JP****BEKO TECHNOLOGIES Sp. z o.o.**

ul. Pańska 73  
 PL - 00-834 Warszawa  
 Tel. +48 22 314 75 40  
 info.pl@beko-technologies.pl

**PL****BEKO TECHNOLOGIES S.E.Asia (Thailand) Ltd.**

75/323 Soi Romklao, Romklao Road  
 Sansab Minburi  
 Bangkok 10510  
 Tel. +66 2-918-2477  
 info.th@beko-technologies.com

**TH****BEKO TECHNOLOGIES CORP.**

900 Great Southwest Pkwy SW  
 US - Atlanta, GA 30336  
 Tel. +1 404 924-6900  
 Fax +1 (404) 629-6666  
 beko@bekousa.com

**US**