

1

2

3

4

5

6

7

8

9

10

A

B

C

D

E

F

G

H

NOTE  
DIMENSIONS BASED  
ON BRUSHLESS  
MOTOR VARIANT

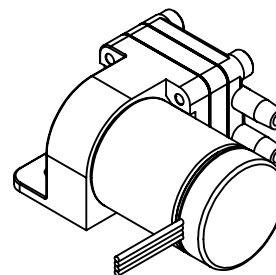
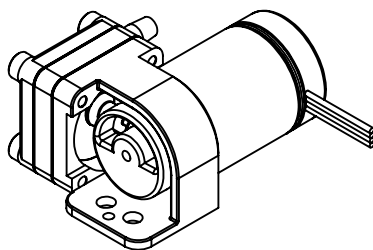
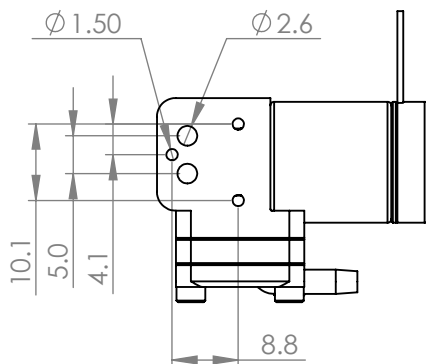
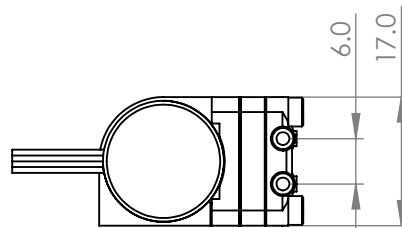
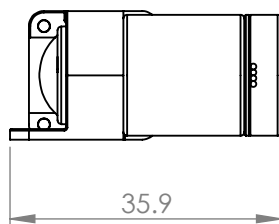
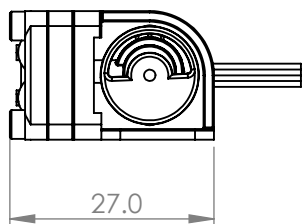
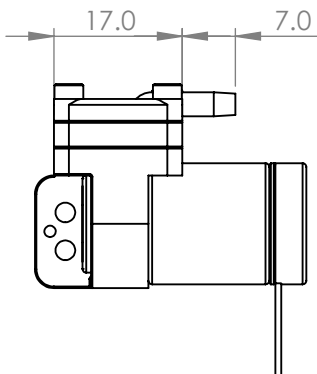

REVISIONS

REV	DESCRIPTION	DRN	DATE
1	RELEASED TO PRODUCTION	IF	10/06/2013

NOTES

MATERIAL

COATING

FINISH

COLOUR

STANDARD TOLLERANCES  
APPLICABLE TO ALL DIMENSIONS ON THIS DRAWING UNLESS OTHERWISE STATED

WHOLE NUMBERS +/- 0.5  
 DECIMAL 1.0 +/- 0.1  
 DECIMAL 1.00 +/- 0.05

CRITICAL DIMENSIONS ARE SHOWN CIRCLED

THIS DRAWING IS THE PROPERTY OF TCS MICROPUMPS LTD. IT IS A CONFIDENTIAL DOCUMENT AND MUST NOT BE COPIED, USED OR ITS CONTENTS DIVULGED WITHOUT PRIOR WRITTEN CONSENT

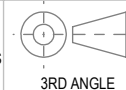

A3 DIMENSIONS IN MM SCALE 1:1

DRAWN BY IF DATE 12/06/2013

CHECKED BY DATE

TITLE Reciprocal Pump

DRG.NO D250	SHEET NO 1 OF 1	REV 1
----------------	--------------------	----------



1

2

3

4

5

6

7

8

9

10