

Datasheet

15 way shielded micro D backshell

RS Stock 377-2534



Specification

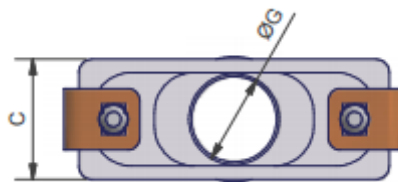
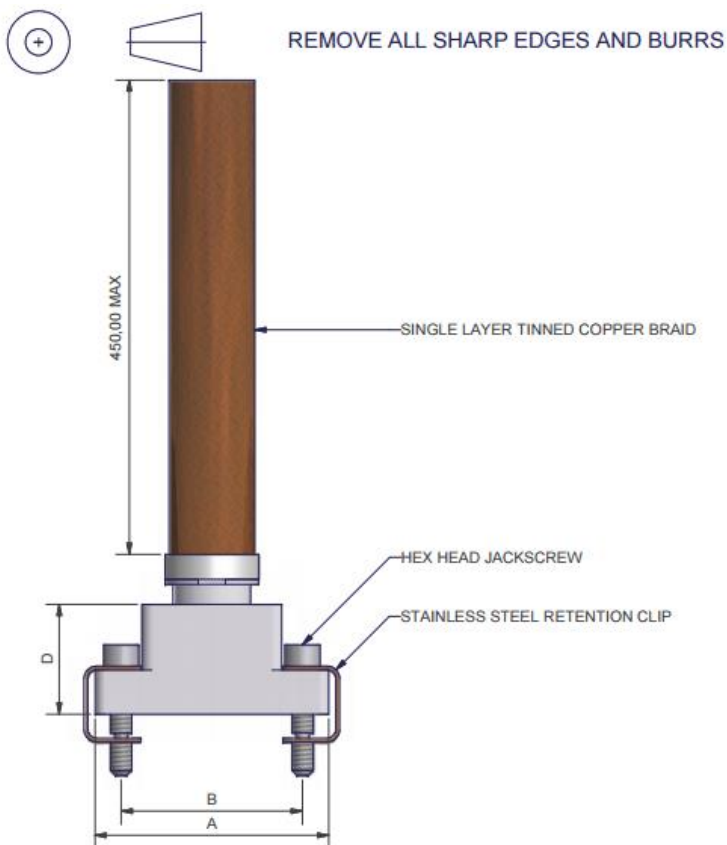

Kit compresses:

- Heat sink boot
- Magnaform adaptor 70MMTB-U (supplied with locking hardware)

TABLE 1

SHELL SIZE	A	B	C	D MAX
09	19,70	14,35	9,0	10,0
15	23,40	18,16	9,0	12,0
21	27,30	21,97	9,0	14,0
25	29,85	24,51	9,0	16,0
31	33,70	28,32	9,0	17,0
37	37,50	32,13	9,0	18,0
51	36,10	30,86	10,0	19,0

TABLE 2

ENTRY SIZE	G MAX
04	3,2
05	4,0
06	4,8
07	5,6
08	6,4

TABLE 3

CODE	PLATING
C	ELECTROLESS NICKEL AMS-C-26074 CLASS 4 GRADE B
M	BRIGHT CADMIUM OVER NICKEL QQ-P-416 TYPE II CLASS 3
Y	YELLOW CHROMATE OVER CADMIUM QQ-P-416 TYPE II CLASS 2