

Toggle Switch

Sealed SPDT

multicomp **PRO**

RoHS
Compliant

Specifications

Mechanical Life : 30,000 make-and-break cycles.
 Contact Resistance : 20 mΩ max. initial @ 2-4V DC
 Insulation Resistance : 1,000 MΩ min.
 Dielectric Strength : 1,500 Vrms min.@sea level.
 Operating Temperature : -30°C to 85°C.
 Rating : 12 Amps @125/250V AC.

Materials

Contact Plating : Silver
 Terminal Plating : Nickel
 Case : Diallyl phthalate (Nylon) (UL94V-0).
 Actuator : Brass, Chrome Plated.
 Bushing : Zin+Silicon
 Terminal/Contact : Copper

Diagram

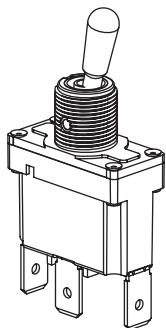
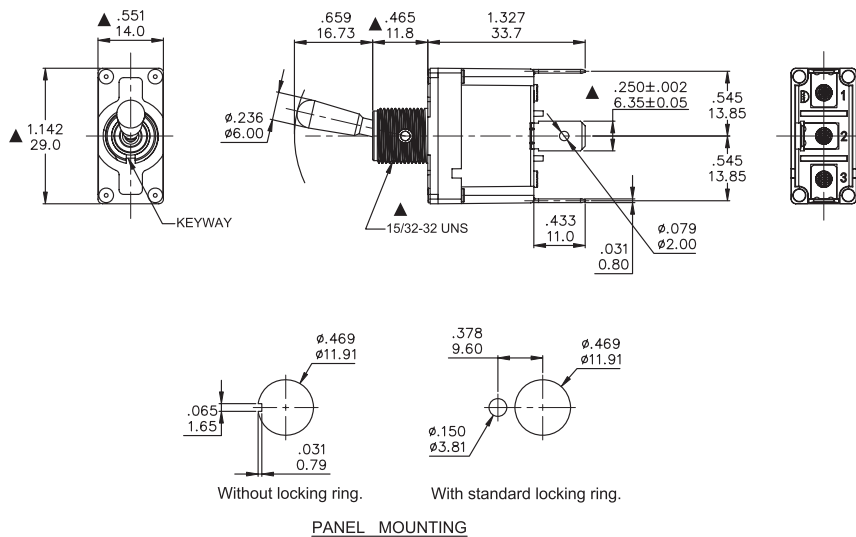

Dimensions : Inches (Millimetres)

Switch Function

| Model | Pos.1 | Pos.2 | Pos.3 |
|--------------------|-------|-------|-------|
| MP1HAS2T1B1M2N1S-5 | ON | NONE | ON |
| Term. Comm. | 2-3 | N/A | 2-1 |
| Schematic | | | |

Newark.com/multicomp-pro
 Farnell.com/multicomp-pro
 sg.element14.com/b/multicomp-pro

multicomp **PRO**

Toggle Switch Sealed SPDT

multicomp PRO

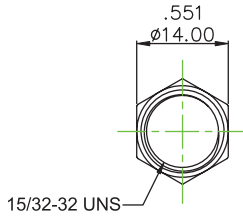

NUT

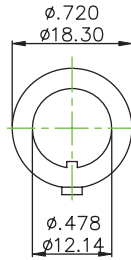
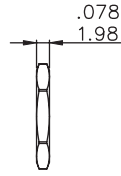

LOCKING RING

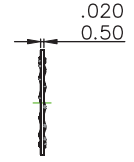
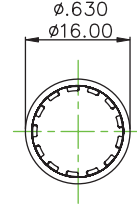
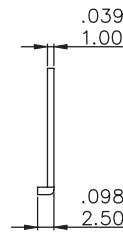

LOCKING WASHER

| Sl. No. | Part Name | Qty. | Material |
|---------|-------------------|------|------------------------|
| 1 | 15/32-32 Inch Nut | 2 | C3604, Nickel Plated |
| 2 | Locking Ring | 1 | SPCC, Zinc Blue Plated |
| 3 | Locking Washer | | Stainless Steel. |

Dimensions : Inches (Millimetres)

Part Number Table

| Description | Part Number |
|--|--------------------|
| Toggle Switch, Quick Disconnect Terminal, ON-NONE-(ON), SPDT | MP1HAS2T1B1M2N1S-5 |

Important Notice : This data sheet and its contents (the "Information") belong to the members of the AVNET group of companies (the "Group") or are licensed to it. No licence is granted for the use of it other than for information purposes in connection with the products to which it relates. No licence of any intellectual property rights is granted. The Information is subject to change without notice and replaces all data sheets previously supplied. The Information supplied is believed to be accurate but the Group assumes no responsibility for its accuracy or completeness, any error in or omission from it or for any use made of it. Users of this data sheet should check for themselves the Information and the suitability of the products for their purpose and not make any assumptions based on information included or omitted. Liability for loss or damage resulting from any reliance on the Information or use of it (including liability resulting from negligence or where the Group was aware of the possibility of such loss or damage arising) is excluded. This will not operate to limit or restrict the Group's liability for death or personal injury resulting from its negligence. Multicomp Pro is the registered trademark of Premier Farnell Limited 2019.

Newark.com/multicomp-pro
Farnell.com/multicomp-pro
sg.element14.com/b/multicomp-pro

multicomp PRO