

# XB5FD53C0

Selector switch, Harmony XB5, flush mounted  
ssw 3 pos 2 pos return to center 2 NO screw  
clamp cp grey



## Main

Range of product	Harmony XB5
Product or component type	Selector switch
Device short name	XB5F
Bezel material	Plastic colour plated grey
Head type	Built-in-flush
Mounting diameter	30.5 mm
Sale per indivisible quantity	1
Shape of signaling unit head	Round
Type of operator	To centre spring return
Operator profile	Black standard handle, unmarked
Operator position information	3 positions +/- 45°
Contacts type and composition	2 NO
Contact operation	Slow-break
Connections - terminals	Screw clamp terminals, <= 2 x 1.5 mm <sup>2</sup> with cable end conforming to IEC 60947-1 Screw clamp terminals, >= 1 x 0.22 mm <sup>2</sup> without cable end conforming to IEC 60947-1

## Complementary

Height	42 mm
Width	36.6 mm
Depth	73 mm
Terminals description ISO n°1	(13-14)NO (23-24)NO
Resistance to high pressure washer	7000000 Pa at 55 °C, distance : 0.1 m
Contacts usage	Standard contacts
Positive opening	Without
Mechanical durability	1000000 cycles
Tightening torque	0.8...1.2 N.m conforming to IEC 60947-1
Shape of screw head	Cross compatible with Philips no 1 screwdriver Cross compatible with pozidriv No 1 screwdriver Slotted compatible with flat Ø 4 mm screwdriver Slotted compatible with flat Ø 5.5 mm screwdriver
Contacts material	Silver alloy (Ag/Ni)
Short-circuit protection	10 A cartridge fuse type gG conforming to IEC 60947-5-1
[I <sub>th</sub> ] conventional free air thermal current	10 A conforming to IEC 60947-5-1
[U <sub>i</sub> ] rated insulation voltage	600 V (pollution degree 3) conforming to IEC 60947-1
[U <sub>imp</sub> ] rated impulse withstand voltage	6 kV conforming to IEC 60947-1
[I <sub>e</sub> ] rated operational current	3 A at 240 V, AC-15, A600 conforming to IEC 60947-5-1 6 A at 120 V, AC-15, A600 conforming to IEC 60947-5-1 0.1 A at 600 V, DC-13, Q600 conforming to IEC 60947-5-1 0.27 A at 250 V, DC-13, Q600 conforming to IEC 60947-5-1 0.55 A at 125 V, DC-13, Q600 conforming to IEC 60947-5-1 1.2 A at 600 V, AC-15, A600 conforming to IEC 60947-5-1

The information provided in this documentation contains general descriptions and/or technical characteristics of the performance of the products contained herein. This documentation is not intended as a substitute for and is not to be used for determining suitability or reliability of these products for specific user applications. It is the duty of any such user or integrator to perform the appropriate and complete risk analysis, evaluation and testing of the products with respect to the relevant specific application or use thereof. Neither Schneider Electric Industries SAS nor any of its affiliates or subsidiaries shall be responsible or liable for misuse of the information contained herein.

Electrical durability	1000000 Cycles, AC-15, 2 A at 230 V, operating rate <3600 cyc/h, load factor: 0.5 conforming to IEC 60947-5-1 appendix C 1000000 Cycles, AC-15, 3 A at 120 V, operating rate <3600 cyc/h, load factor: 0.5 conforming to IEC 60947-5-1 appendix C 1000000 Cycles, AC-15, 4 A at 24 V, operating rate <3600 cyc/h, load factor: 0.5 conforming to IEC 60947-5-1 appendix C 1000000 Cycles, DC-13, 0.2 A at 110 V, operating rate <3600 cyc/h, load factor: 0.5 conforming to IEC 60947-5-1 appendix C 1000000 cycles, DC-13, 0.5 A at 24 V, operating rate <3600 cyc/h, load factor: 0.5 conforming to IEC 60947-5-1 appendix C
Electrical reliability	$\Lambda < 10\exp(-6)$ at 5 V, 1 mA in clean environment conforming to IEC 60947-5-4 $\Lambda < 10\exp(-8)$ at 17 V, 5 mA in clean environment conforming to IEC 60947-5-4
Device presentation	Complete product

## Environment

Protective treatment	TH
Ambient air temperature for storage	-40...70 °C
Ambient air temperature for operation	-40...70 °C
Electrical shock protection class	Class II conforming to IEC 60536
IP degree of protection	IP66 conforming to IEC 60529 IP67
NEMA degree of protection	NEMA 13 NEMA 4X
IK degree of protection	IK03 conforming to IEC 50102
Standards	IEC 60947-1 UL 508 JIS C8201-5-1 IEC 60947-5-4 IEC 60947-5-1 CSA C22.2 No 14 JIS C8201-1
Product certifications	UL listed CSA
Vibration resistance	5 gn (f= 2...500 Hz) conforming to IEC 60068-2-6
Shock resistance	30 gn (duration = 18 ms) for half sine wave acceleration conforming to IEC 60068-2-27 50 gn (duration = 11 ms) for half sine wave acceleration conforming to IEC 60068-2-27

## Offer Sustainability

REACH Regulation	 <a href="#">REACH Declaration</a>
REACH free of SVHC	Yes
EU RoHS Directive	Pro-active compliance (Product out of EU RoHS legal scope)  <a href="#">EU RoHS Declaration</a>
Toxic heavy metal free	Yes
Mercury free	Yes
China RoHS Regulation	 <a href="#">China RoHS Declaration</a>
RoHS exemption information	 <a href="#">Yes</a>
WEEE	The product must be disposed on European Union markets following specific waste collection and never end up in rubbish bins

Dimensions

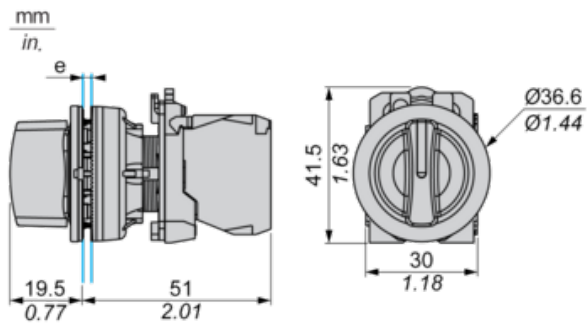

e: Clamping thickness: 1 to 6 mm / 0.04 to 0.24 in.

Panel Cut-out for Pushbuttons, Switches and Pilot Lights (Finished Holes, Ready for Installation)

Connection by Screw Clamp Terminals or Plug-in Connectors

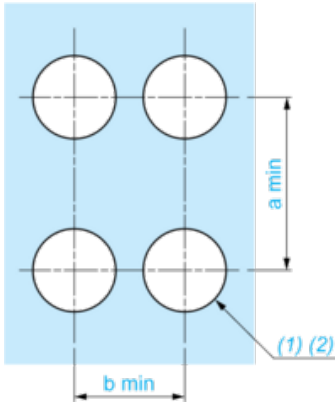

(1) Diameter on finished panel or support

(2)  $\text{Ø}30.75 \text{ mm}$  recommended ( $\text{Ø}30.5 \text{ }_0^{+0.5}$ ) /  $\text{Ø}1.21 \text{ in.}$  recommended ( $\text{Ø}1.20 \text{ in. }_0^{+0.0196}$ )

Connections	a in mm	a in in.	b in mm	b in in.
By screw clamp terminals or plug-in connector	40	1.57	40	1.57
By Faston connectors	45	1.77	40	1.57

---

Electrical Composition Corresponding to Code C3

---

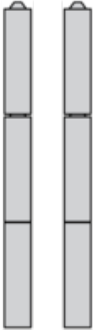

---

Electrical Composition Corresponding to Code C4

---

---

Electrical Composition Corresponding to Code C5

---

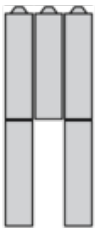

---

Electrical Composition Corresponding to Code C6

---

---

Electrical Composition Corresponding to Code C7

---

## Electrical Composition Corresponding to Code C8

---

## Electrical Composition Corresponding to Codes C9, C11, SF1 and SR1

---

## Electrical Composition Corresponding to Code C15

---

1 N/O

1 N/C

1 N/O + N/C or 1 N/O + N/O or 1 N/C + N/C

## Legend

---

Single contact

Double contact

Light block





Possible location



### Sequence of Contacts Fitted to 2-position Selector Switch Body

#### Position 315°



Push	Position	Top			
Bottom					
Location		Left	Centre	Right	
State		0	0	0	
Contacts	N/O		open	open	open
N/C		closed	closed	closed	

#### Position 45°



Push	Position	Top			
Bottom					
Location		Left	Centre	Right	
State		1	1	1	
Contacts	N/O		closed	closed	closed
N/C		open	open	open	