

Datasheet

Telephone Slide LED Indicator Lamp

RS Stock number 204-243

Dimensions (mm):

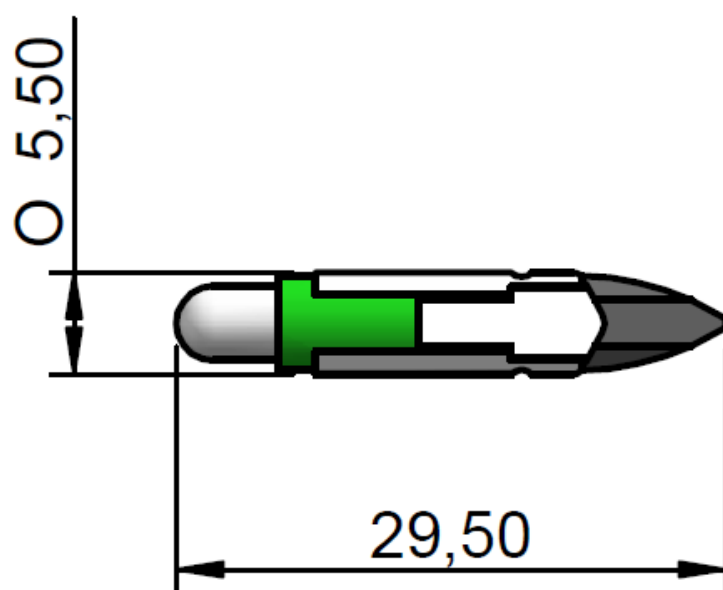

Specifications:

LED/Multiled	LED
Mounting Size	-
Mounting Finish	-
Protection	-
Mount Holder	T5.5 SlideBase
Chip Qty	1
Indicator Colour	Green
Optimum Voltage (V)	28V dc
Rectifier	-

AC Current	-
DC Current	15mA
Voltage Tolerance	10%
Optimum Temperature	-30°C ... +60°C
Storage Temperature	-30°C...+60°C
Contact Tab	T5.5 Slide bar
Wavelength (nm)	525
Intensity	2100mcd