

Datasheet

RS 6.8nF $\pm 1\%$ 63 V dc Radial Through Hole Polystyrene Film Capacitor EXFS

RS Stock 116-313

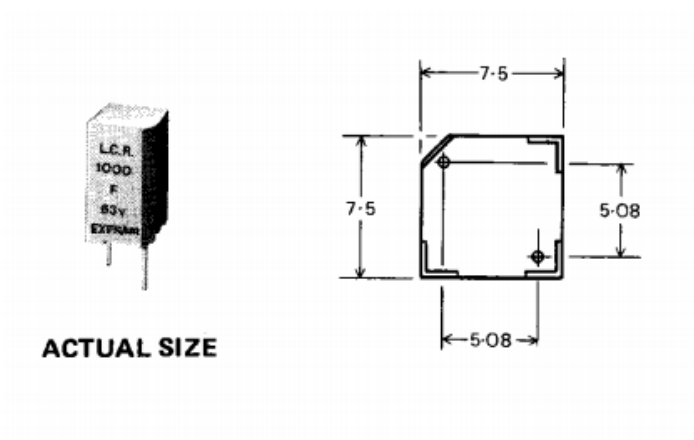

Specifications

These capacitors are particularly suitable for telephone equipment where low loss, excellent stability and high reliability are required.

The "high-rise" shape facilitates high packing density.

They consist of extended foil polystyrene capacitors sealed into a case with epoxy resin, both materials being flame retardant and resistance to cleaning fluids.

Characteristics

- Capacitance Range: 47-15,000 pf
- Capacitance Tolerance: $\pm 1\%$, 2%, 5% (or 1 $\frac{1}{2}$ pf whichever is the greater)
- Voltage: 63V D.C
- Insulation Resistance: Greater than 500,000 M
- Loss Factor (1kHz): 3×10^{-4}
- Temperature Coefficient: -110 ± 60 p.p.m./ $^{\circ}\text{C}$
- Climatic Category: 40/070/56