

FEATURES

- Heavy-duty die cast zinc handle
- Designed for repetitive fixing or clamping
- Ideal for use in small spaces
- Blackened steel inserts
- M5 to M12 thread sizes

RS PRO Clamping Lever, M6 x 16mm

RS Stock No.: 478-866



RS Professionally Approved Products bring to you professional quality parts across all product categories. Our product range has been tested by engineers and provides a comparable quality to the leading brands without paying a premium price.

Product Description

These die cast zinc clamping leavers with a steel metric male thread from our own RS PRO brand are designed primarily to tighten or loosen screws eliminating the need for any special tools or wrenches. Clamp levers are ideal for use in hard to reach or confined spaces. Clamp levers are available in a range of thread sizes and stem lengths to suit a wide variety of applications.

General Specifications

Lever Type	Clamping Lever
Thread Gender	Male
Thread Size	M6
Handle Material	Die Cast Zinc
Shaft Material	Stainless Steel
Insert Material	Stainless Steel
Colour	Black
Applications	Clamping levers are utilised in applications where screws are repeatedly tightened or loosened. They are useful when machinery must be swapped over, maintained or height adjustment is required regularly; Height Adjustment - Clamping levers can be used to adjust the height of tripods or metal framework and stands; Machinery Maintenance - Clamping levers are used to release fixings while performing critical machine maintenance. The time saving device allows for quick release and retightening of screws saving valuable machine down time

Mechanical Specifications

Thread/Insert Length	16mm
Length	42mm

Approvals

Compliance/Certifications	RoHS Certificate Of Compliance
---------------------------	--------------------------------

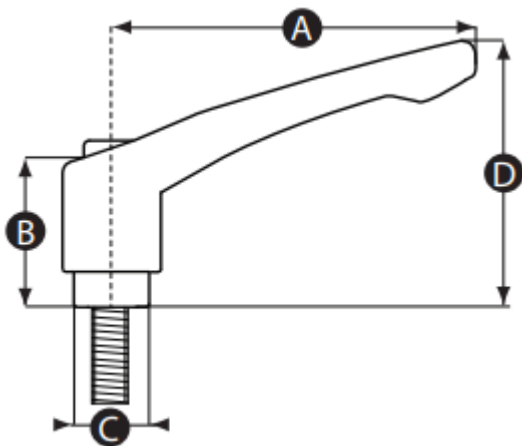

Part No.	A	B	C	D	Thread size	Thread length (mm)	Insert material	Handle Colour
478276	42	25	10	37	M5	16	Steel	Black
479015	42	25	10	37	M5	20	Steel	Black
479009	42	25	10	37	M6	16	Steel	Black
478995	42	25	10	37	M6	20	Steel	Black
479011	42	25	10	37	M6	32	Steel	Black
478866	42	25	10	37	M6	16	Stainless Steel	Black
478084	42	25	10	37	M6	20	Stainless Steel	Black
478860	42	25	10	37	M6	32	Stainless Steel	Black
478816	65	31	14	49	M8	16	Steel	Black
478826	65	31	14	49	M8	20	Steel	Black
478292	65	31	14	49	M8	25	Steel	Black
478298	65	31	14	49	M8	32	Steel	Black
478305	65	31	14	49	M8	40	Steel	Black
478254	65	31	14	49	M8	50	Steel	Black
Part No.	A	B	C	D	Thread size	Thread length (mm)	Insert material	Handle Colour
478129	65	31	14	49	M8	20	Stainless Steel	Black
478125	65	31	14	49	M8	25	Stainless Steel	Black
478103	65	31	14	49	M8	32	Stainless Steel	Black
478080	65	31	14	49	M8	40	Stainless Steel	Black
478090	65	31	14	49	M8	50	Stainless Steel	Black
478309	78	36	16	57	M10	20	Steel	Black
478882	78	36	16	57	M10	32	Steel	Black
478872	78	36	16	57	M10	40	Steel	Black
478848	78	36	16	57	M10	50	Steel	Black
478096	78	36	16	57	M10	20	Stainless Steel	Black
478315	78	36	16	57	M10	32	Stainless Steel	Black
478282	78	36	16	57	M10	40	Stainless Steel	Black
478888	92	43	19	65	M10	20	Steel	Black
478898	92	43	19	65	M10	32	Steel	Black
478894	92	43	19	65	M10	40	Steel	Black
478876	92	43	19	65	M10	50	Steel	Black
478264	92	43	19	65	M10	50	Stainless Steel	Black
478844	92	43	19	65	M12	32	Steel	Black

Levers



478854	92	43	19	65	M12	40	Steel	Black
478850	92	43	19	65	M12	50	Steel	Black
478135	92	43	19	65	M12	63	Steel	Black
478270	92	43	19	65	M12	32	Stainless Steel	Black
478276	92	43	19	65	M12	40	Stainless Steel	Black
478260	92	43	19	65	M12	50	Stainless Steel	Black
478169	92	43	19	65	M12	63	Stainless Steel	Black