

Datasheet

LED Indicator with Sounder 22mm Red 12Vac/dc

RS Stock Number: 909-2553



Representative of range

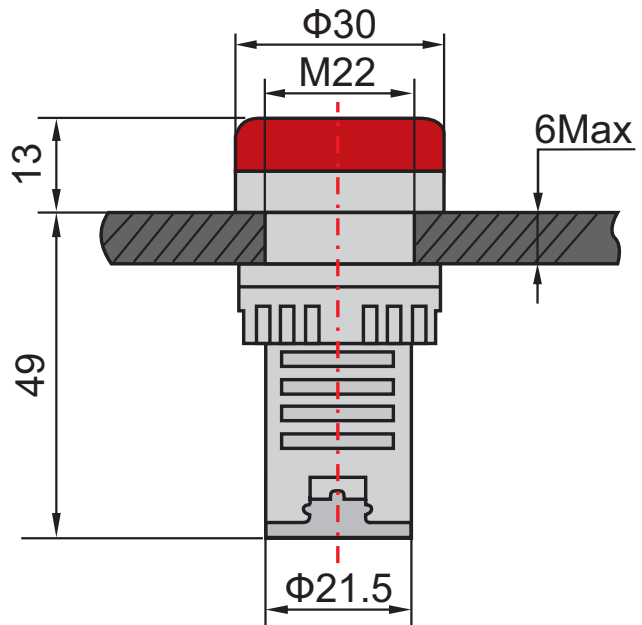

Technical Specification

Colour	Red
Nominal Voltage (V _n)	12V ac/dc
Operating Voltage Range	V _n +/- 15%
Frequency (ac)	50 - 60Hz
Insulation Resistance	≥ 2MΩ
Insulation Withstand	2.5kVac, 1 minute
Current Draw	≤ 20mA
IP Rating (from front, panel mounted)	Not applicable
Brightness	≥ 60 cd/m ³
Operational Life	30,000 hours
Relative Humidity	≤ 98%
Operating Temperature Range	-25°C to +55°C