





Datasheet

Stock Number:	188-1141	188-1142	188-1143	188-1144	188-1145
					
Colour:	BLUE	RED	GREEN	YELLOW	WHITE



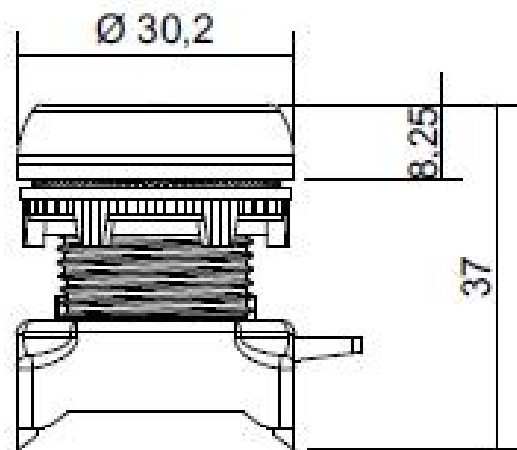

22mm Illuminated Flush Push Button Head



Illuminated flush pushbutton heads for use with the RS pro modular plastic push button series. Robust design in a variety of colours with modern aesthetics delivered via silver coloured bezel. Simple installation via standard lock nut.

Specifications:

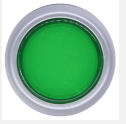
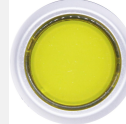
- 22mm Diameter
- Sprung return head
- IP65 rated
- Contact block mounting clip included
- Stackable design for contact blocks (max 6)
- Mechanical life more than 1 million uses.

Stock Number:	188-1141	188-1142	188-1143	188-1144	188-1145
					
Colour	BLUE	RED	GREEN	YELLOW	WHITE
Cut out Diameter	22.5mm				
Actuation	Spring Return				
Style	Flush				
IP Rating	IP65				
Shape	Round				
Mounting Type	Panel Mounted				
Body Material	Plastic				

Accessories:

RS Stock Number	Accessory Type
188-1168	Normally Open Contact Block – Screw Terminal
188-1169	Normally Closed Contact Block – Screw Terminal
188-1170	Normally Open Contact Block – Spring Terminal
188-1171	Normally Closed Contact Block – Spring Terminal
188-1172	LED Light Block Red 12Vac/dc
188-1173	LED Light Block Blue 12Vac/dc
188-1174	LED Light Block White 12Vac/dc
188-1176	LED Light Block Yellow 12Vac/dc
188-1177	LED Light Block Green 12Vac/dc
188-1178	LED Light Block Amber 12Vac/dc
188-1179	LED Light Block Red 24Vac/dc
188-1180	LED Light Block Blue 24Vac/dc
188-1182	LED Light Block White 24Vac/dc
188-1183	LED Light Block Yellow 24Vac/dc
188-1184	LED Light Block Green 24Vac/dc
188-1185	LED Light Block Amber 24Vac/dc
188-1186	LED Light Block Red 110Vac
188-1187	LED Light Block Blue 110Vac
188-1188	LED Light Block White 110Vac
188-1189	LED Light Block Yellow 110Vac
188-1190	LED Light Block Green 110Vac

188-1191	LED Light Block Amber 110Vac
188-1192	LED Light Block Red 240Vac
188-1193	LED Light Block Blue 240Vac
188-1194	LED Light Block White 240Vac
188-1195	LED Light Block Yellow 240Vac
188-1196	LED Light Block Green 240Vac
188-1198	LED Light Block Amber 240Vac
175-3954	Legend Plate 0-I Pack of 5
175-3955	Legend Plate CLOSE Pack of 5
175-3956	Legend Plate DOWN Pack of 5
175-3958	Legend Plate FORWARD Pack of 5
175-3959	Legend Plate I-O-II Pack of 5
175-3960	Legend Plate OFF - ON Pack of 5
175-3961	Legend Plate OPEN Pack of 5
175-3962	Legend Plate RESET Pack of 5
175-3964	Legend Plate REVERSE Pack of 5
175-3965	Legend Plate START Pack of 5
175-3966	Legend Plate STOP Pack of 5
175-3967	Legend Plate UP Pack of 5
182-8655	Pushbutton Enclosure, 1 Hole, Plastic, Grey, 22mm Cut Out
182-8656	Pushbutton Enclosure, 2 Hole, Plastic, Grey, 22mm Cut Outs
182-8657	Pushbutton Enclosure, 3 Hole, Plastic, Grey, 22mm Cut Outs
182-8658	Pushbutton Enclosure, 4 Hole, Plastic, Grey, 22mm Cut Outs
136-8582	Pushbutton Enclosure, 1 Hole, Die Cast Aluminium, Yellow, 22mm Cut Out
136-8581	Pushbutton Enclosure, 1 Hole, Die Cast Aluminium, Yellow, 22mm Cut Out