

DU145

Automatic Bypass Valve

INSTALLATION INSTRUCTIONS

Building Regulations

An Automatic Bypass Valve (DU145) controls water flow in the Heating Circuit according to the water pressure across it and is used to maintain a minimum flow rate through the boiler and to limit circulation pressure when other water paths are closed.

A bypass circuit must be installed if the Boiler manufacturer requires one, or specifies that a minimum flow rate has to be maintained whilst the Boiler is firing.

The use of Automatic Bypass Valves becomes particularly important when Heating Systems include large numbers of Thermostatic Radiator Valves (TRVs) – whilst the TRVs are open the Automatic Bypass Valve remains closed, however, as the TRVs start to close, the Automatic Bypass Valve starts to open maintaining the required water flow through the boiler. Using an Automatic Bypass Valve is also likely to reduce noise in systems caused by excess water velocities.

Because manual or fixed position valves do not regulate the flow and allow water to bypass even when it is not necessary, Building Regulations require bypass circuits to use Automatic Bypass Valves and not fixed position valves.

Location in System

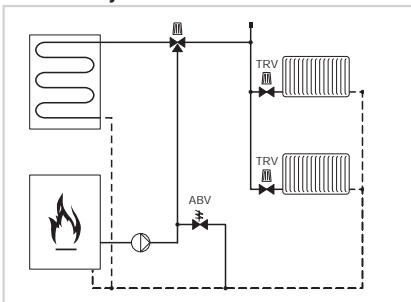

System with stored hot water

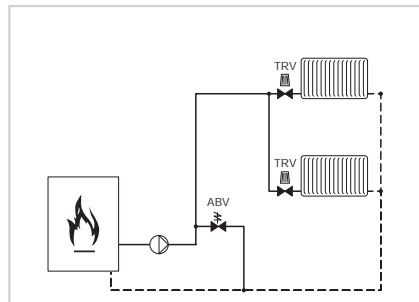

System with combi boiler

Installation

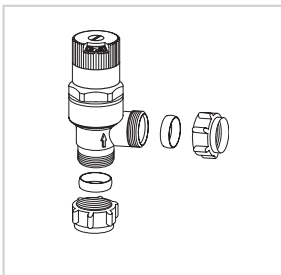

Can be mounted in any direction but for ease of setting, the window on the cap should be forward facing

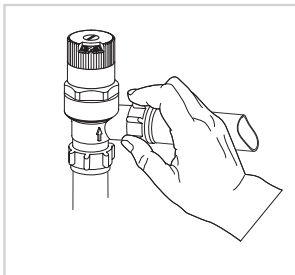

Install the DU145 with flow in the direction of the arrow on the body

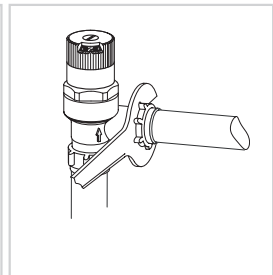

Use a correctly sized open ended spanner to tighten. Do not over tighten.

Setting Procedure

- 1) Commission and balance the Heating System – take note of the selected pump speed.
- 2) Using the Boiler manufacturer's instructions, find the minimum flow requirement for the Boiler.
- 3) Using the Pump manufacturer's Pump curves determine the available Pump head when operating at the required minimum flow and the selected Pump speed.
- 4) Using the DU145 Setting chart, the calculated Pump Head and the minimum Boiler Flow to find the optimum setting for the DU145

Note: Loosen the locking screw (1) and turn the adjustment knob (3) to the setting.

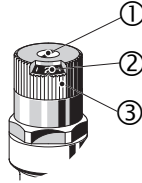

Should persistent water velocity noise occur in the Heating System, gradually turn the DU145 to a lower setting until the noise is eliminated.

Important: Once set, the valve can be locked in position by tightening the screw (1) in the cap.

Important: Do not screw the setting position beyond position 6. Damage to the ABV will result!

Example:

Minimum flow 300 l/h - Pump speed 3.
Pump chart indicates 4 m head (Use Pump Manufactures chart).

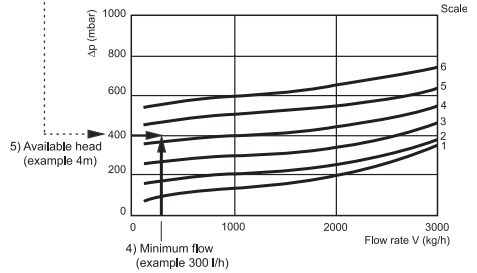
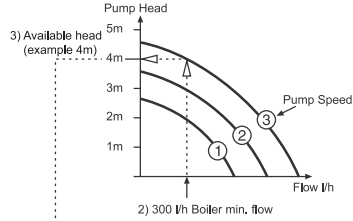

Using DU145 Setting Chart:

4m Head / Minimum Flow 300 l/h
Result = Set DU145 to setting 4.2

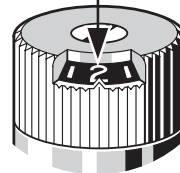
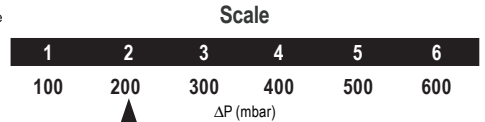
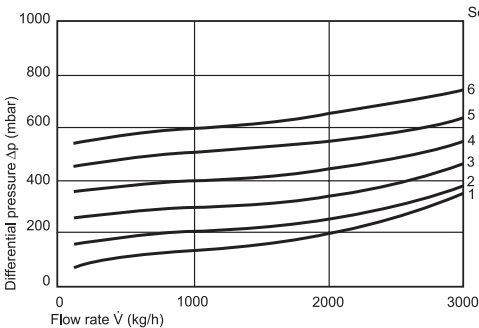

Factory setting = 2