

RevNo	Revision note	Date	Signature	Checked
-------	---------------	------	-----------	---------

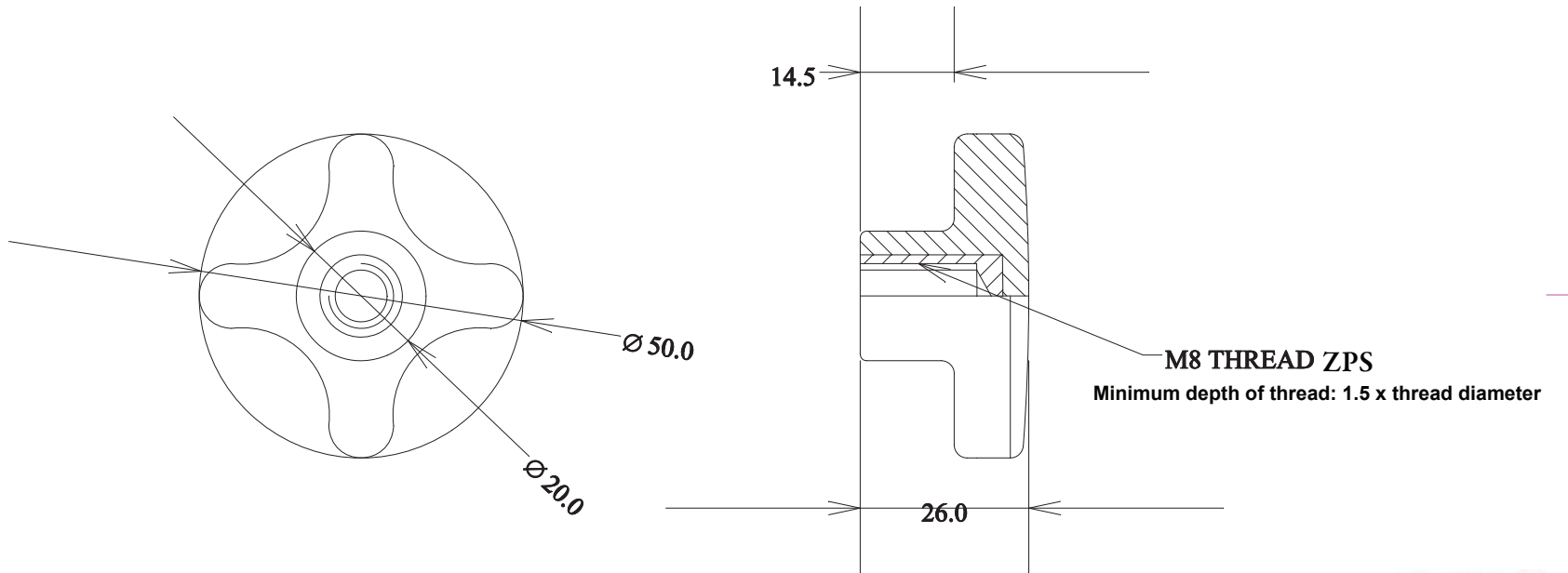

Itemref	Quantity	Title <b>Star Knob - Polypropylene REV.2</b>			Article No./Reference	
Designed by	Checked by	Approved by - date	Filename	Date	Scale	
				06/04/10		
				<b>RS 7027718</b>		
				Edition	Sheet	
				1	1/1	