

Connector PowerTOP® Xtra - Part no. 14219

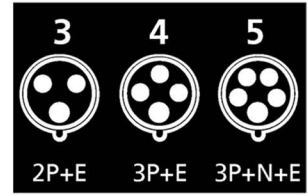

- screw terminals
- with rubberised grip area
- frame terminals
- 63A: SoftCONTACT, 125A: TorsionSpringCONTACT
- with highly heat resistant contact carrier
- cable gland and sealing
- strain relief and protection against kinking
- enclosure with thread lock
- two safety slides
- products with pilot contact: part no. + index P

Protection type IP 67
 Ampere 125A
 Poles 4p
 Voltage 400V
 Hertz 50-60Hz
 Earth position 6h
 Contact highly heat resistant contact carrier
 Connection technology Screw terminals, TorsionSpringCONTACT

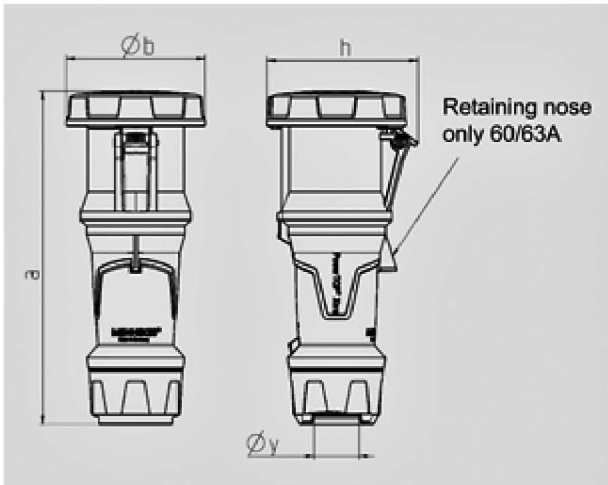

Drawing	Amp.	63			125		
		3	4	5	3	4	5
3 MB 68	Poles						
Dim. in mm	a	270	270	270	310	310	310
	b	113	113	113	125	125	125
	h	123	123	123	135	135	135
	y	36	36	36	49	49	49
Terminal for cond. cross		6	6	6	25	25	25
section (mm²) min.-max.		-16	-16	-16	-50	-50	-50

