

Datasheet

RS Pro AL Series Wire-wound SMD Inductor with a Ceramic Core, 2.2 nH ± 0.1 nH Wire-Wound 440mA Idc Q:13

RS Stock No: 763-1437

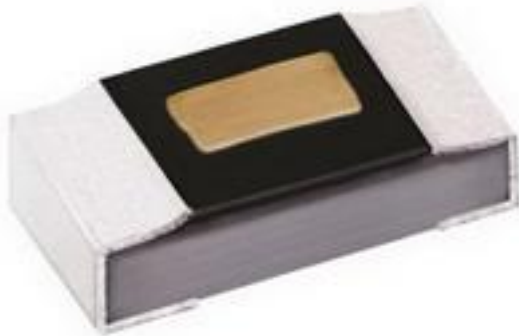

Product Details

RS Pro SMD inductor offers an inductance of 2.2 nH by withstanding DC current up to 440 mA. This photolithographically etched single layer ceramic chip provides high SRF, excellent Q and superior temperature stability. The stable inductor with a ceramic core fulfils critical tolerance needs with optimum accuracy.

Features and Benefits

- Photolithographic single layer ceramic chip
- High SRF, excellent Q, superior temperature stability
- Tight tolerance of $\pm 1\%$ or ± 0.1 nH
- Self-resonant frequency controlled within 10%
- Stable inductance in high frequency circuit
- Highly stable design for critical needs

**Specifications:**

Core Material	Ceramic
Inductor Construction	Wire Wound
Depth	0.5 mm
Dimensions	1 x 0.5 x 0.32 mm
Height	0.32 mm
Length	1 mm
Maximum DC Current	440 mA
Maximum DC Resistance	350 mΩ
Maximum Operating Temperature	+85°C
Maximum Self Resonant Frequency	8000 MHz
Minimum Operating Temperature	-40°C
Minimum Quality Factor	13
Tolerance	±0.1 nH
Inductance	2.2 nH
Package/Case	0402
Package Type	Reel

Thin Film Chip Inductor

AL Series

Scope

— 0201 and 0402 and 0603 series inductor is a photo lithographically etched single layer ceramic chip. This design provides high SRF, excellent Q, and superior temperature stability. This highly stable inductor family is specifically designed for critical tolerance needs.

Features

- Photolithographic single layer ceramic chip
- High SRF, excellent Q, superior temperature stability
- Tight tolerance of $\pm 1\%$ or $\pm 0.1\text{nH}$
- Self resonant frequency controlled within 10%
- Stable inductance in high frequency circuit
- Highly stable design for critical needs

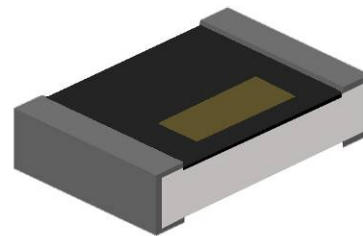

Applications

- Cellular Telephone, Pagers and GPS Products
- VCO, TCXO Circuit and RF Transceiver Module
- Wireless LAN, Bluetooth Module, Communication Appliances

Construction

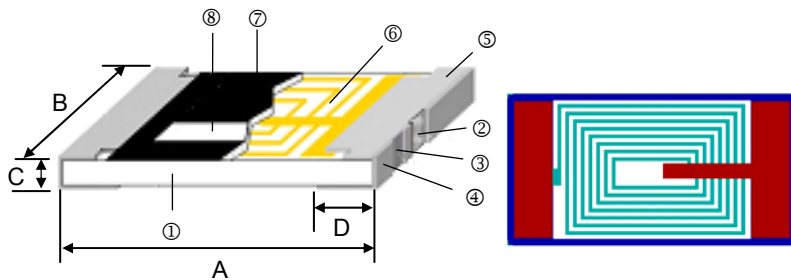

① Alumina Substrate	④ External Electrode (Sn)	⑦ Overcoat
② Inner Electrode (Ni-Cr)	⑤ Edge Electrode	⑧ Marking
③ Barrier Layer (Ni)	⑥ Cu Circuits	

Dimensions

Unit: mm

Type	Size (Inch)	A	B	C	D	Weight (g) (1000pcs)
AL01	0201	0.60±0.05	0.30±0.05	0.23±0.05	0.15±0.05	0.3
AL02	0402	1.0±0.05	0.5±0.05	0.32±0.05	0.2±0.10	0.9
AL03	0603	1.6±0.10	0.8±0.10	0.45±0.10	0.3±0.20	2.97





■ Standard Electrical Specifications

AL01 Chip Inductors / Standard Type

Inductance (nH)	Inductance Tolerance (nH or %)	Quality Factor min.	SRF (GHz) min.	DCR (Ω) max.	IDC (mA) max.
0.1	±0.1, 0.2, 0.3nH	8 / 500MHz	9	0.20	400
0.2	±0.1, 0.2, 0.3nH	8 / 500MHz	9	0.20	400
0.3	±0.1, 0.2, 0.3nH	8 / 500MHz	9	0.20	400
0.4	±0.1, 0.2, 0.3nH	8 / 500MHz	9	0.25	350
0.5	±0.1, 0.2, 0.3nH	8 / 500MHz	9	0.25	350
0.6	±0.1, 0.2, 0.3nH	8 / 500MHz	9	0.25	350
0.7	±0.1, 0.2, 0.3nH	8 / 500MHz	9	0.30	300
0.8	±0.1, 0.2, 0.3nH	8 / 500MHz	9	0.30	300
0.9	±0.1, 0.2, 0.3nH	8 / 500MHz	9	0.30	300
1.0	±0.1, 0.2, 0.3nH	8 / 500MHz	9	0.30	300
1.1	±0.1, 0.2, 0.3nH	8 / 500MHz	9	0.35	300
1.2	±0.1, 0.2, 0.3nH	8 / 500MHz	9	0.35	300
1.3	±0.1, 0.2, 0.3nH	8 / 500MHz	9	0.45	250
1.4	±0.1, 0.2, 0.3nH	8 / 500MHz	9	0.45	250
1.5	±0.1, 0.2, 0.3nH	8 / 500MHz	9	0.45	250
1.6	±0.1, 0.2, 0.3nH	8 / 500MHz	9	0.55	200
1.7	±0.1, 0.2, 0.3nH	8 / 500MHz	9	0.55	200
1.8	±0.1, 0.2, 0.3nH	8 / 500MHz	9	0.55	200
1.9	±0.1, 0.2, 0.3nH	8 / 500MHz	9	0.55	200
2.0	±0.1, 0.2, 0.3nH	8 / 500MHz	8	0.70	200
2.1	±0.1, 0.2, 0.3nH	8 / 500MHz	8	0.70	200
2.2	±0.1, 0.2, 0.3nH	8 / 500MHz	8	0.70	200
2.3	±0.1, 0.2, 0.3nH	8 / 500MHz	8	0.80	150
2.4	±0.1, 0.2, 0.3nH	8 / 500MHz	8	0.80	150
2.5	±0.1, 0.2, 0.3nH	8 / 500MHz	8	0.80	150
2.6	±0.1, 0.2, 0.3nH	8 / 500MHz	8	0.80	150
2.7	±0.1, 0.2, 0.3nH	8 / 500MHz	8	0.80	150
2.8	±0.1, 0.2, 0.3nH	8 / 500MHz	6	1.00	150
2.9	±0.1, 0.2, 0.3nH	8 / 500MHz	6	1.00	150
3.0	±0.1, 0.2, 0.3nH	8 / 500MHz	6	1.00	150
3.1	±0.1, 0.2, 0.3nH	8 / 500MHz	6	1.00	150
3.2	±0.1, 0.2, 0.3nH	8 / 500MHz	6	1.00	150
3.3	±0.1, 0.2, 0.3nH	8 / 500MHz	6	1.00	150
3.4	±0.1, 0.2, 0.3nH	8 / 500MHz	6	1.20	150
3.5	±0.1, 0.2, 0.3nH	8 / 500MHz	6	1.20	150
3.6	±0.1, 0.2, 0.3nH	8 / 500MHz	6	1.20	150
3.7	±0.1, 0.2, 0.3nH	8 / 500MHz	6	1.20	150
3.8	±0.1, 0.2, 0.3nH	8 / 500MHz	6	1.20	150
3.9	±0.1, 0.2, 0.3nH	8 / 500MHz	6	1.20	150
4.0	±0.1, 0.2, 0.3nH	8 / 500MHz	6	1.20	150
4.4	±0.1, 0.2, 0.3nH	8 / 500MHz	6	1.30	140
4.7	±0.1, 0.2, 0.3nH	8 / 500MHz	6	1.40	130
4.9	±0.1, 0.2, 0.3nH	8 / 500MHz	6	1.60	130
5.6	±2, ±5%	8 / 500MHz	4	1.80	130
6.1	±2, ±5%	8 / 500MHz	4	2.00	120
6.8	±2, ±5%	8 / 500MHz	4	2.30	110
7.4	±2, ±5%	8 / 500MHz	4	2.80	110
8.2	±2, ±5%	8 / 500MHz	3	3.00	110
9.1	±2, ±5%	8 / 500MHz	3	3.25	100
9.2	±2, ±5%	8 / 500MHz	3	3.25	100
10	±2, ±5%	8 / 500MHz	2	3.50	80

AL01-01 Chip Inductors / High Current Type

Inductance (nH)	Inductance Tolerance (nH or %)	Quality Factor min.	SRF (GHz) min.	DCR (Ω) max.	IDC (mA) max.
0.1	$\pm 0.1, 0.2, 0.3nH$	10 / 500MHz	6	0.05	600
0.2	$\pm 0.1, 0.2, 0.3nH$	10 / 500MHz	6	0.05	600
0.3	$\pm 0.1, 0.2, 0.3nH$	10 / 500MHz	6	0.05	600
0.4	$\pm 0.1, 0.2, 0.3nH$	10 / 500MHz	6	0.05	600
0.5	$\pm 0.1, 0.2, 0.3nH$	10 / 500MHz	6	0.10	600
0.6	$\pm 0.1, 0.2, 0.3nH$	10 / 500MHz	6	0.10	600
0.7	$\pm 0.1, 0.2, 0.3nH$	10 / 500MHz	6	0.10	600
0.8	$\pm 0.1, 0.2, 0.3nH$	10 / 500MHz	6	0.10	600
0.9	$\pm 0.1, 0.2, 0.3nH$	10 / 500MHz	6	0.10	600
1.0	$\pm 0.1, 0.2, 0.3nH$	10 / 500MHz	6	0.15	600
1.1	$\pm 0.1, 0.2, 0.3nH$	10 / 500MHz	6	0.15	600
1.2	$\pm 0.1, 0.2, 0.3nH$	10 / 500MHz	6	0.15	600
1.3	$\pm 0.1, 0.2, 0.3nH$	10 / 500MHz	6	0.20	600
1.4	$\pm 0.1, 0.2, 0.3nH$	10 / 500MHz	6	0.20	600
1.5	$\pm 0.1, 0.2, 0.3nH$	10 / 500MHz	6	0.25	600
1.6	$\pm 0.1, 0.2, 0.3nH$	10 / 500MHz	6	0.25	600
1.7	$\pm 0.1, 0.2, 0.3nH$	10 / 500MHz	6	0.30	500
1.8	$\pm 0.1, 0.2, 0.3nH$	10 / 500MHz	6	0.30	500
1.9	$\pm 0.1, 0.2, 0.3nH$	10 / 500MHz	6	0.30	500
2.0	$\pm 0.1, 0.2, 0.3nH$	10 / 500MHz	6	0.30	500
2.1	$\pm 0.1, 0.2, 0.3nH$	10 / 500MHz	6	0.30	500
2.2	$\pm 0.1, 0.2, 0.3nH$	10 / 500MHz	6	0.35	500
2.3	$\pm 0.1, 0.2, 0.3nH$	10 / 500MHz	6	0.35	500
2.4	$\pm 0.1, 0.2, 0.3nH$	10 / 500MHz	6	0.35	450
2.5	$\pm 0.1, 0.2, 0.3nH$	10 / 500MHz	6	0.35	450
2.6	$\pm 0.1, 0.2, 0.3nH$	10 / 500MHz	6	0.35	450
2.7	$\pm 0.1, 0.2, 0.3nH$	10 / 500MHz	6	0.35	450
2.8	$\pm 0.1, 0.2, 0.3nH$	10 / 500MHz	6	0.50	450
2.9	$\pm 0.1, 0.2, 0.3nH$	10 / 500MHz	6	0.50	450
3.0	$\pm 0.1, 0.2, 0.3nH$	10 / 500MHz	6	0.50	400
3.1	$\pm 0.1, 0.2, 0.3nH$	10 / 500MHz	6	0.50	400
3.2	$\pm 0.1, 0.2, 0.3nH$	10 / 500MHz	6	0.50	400
3.3	$\pm 0.1, 0.2, 0.3nH$	10 / 500MHz	6	0.50	400
3.4	$\pm 0.1, 0.2, 0.3nH$	10 / 500MHz	6	0.80	350
3.5	$\pm 0.1, 0.2, 0.3nH$	10 / 500MHz	6	0.80	350
3.6	$\pm 0.1, 0.2, 0.3nH$	10 / 500MHz	6	0.80	350
3.7	$\pm 0.1, 0.2, 0.3nH$	10 / 500MHz	6	0.80	350
3.8	$\pm 0.1, 0.2, 0.3nH$	10 / 500MHz	6	0.80	350
3.9	$\pm 0.1, 0.2, 0.3nH$	10 / 500MHz	6	0.80	350
4.0	$\pm 0.1, 0.2, 0.3nH$	10 / 500MHz	6	0.80	350

AL02 Chip Inductors / Standard Type

Inductance (nH)	Inductance Tolerance (nH or %)	Quality Factor min.	SRF (GHz) min.	DCR (Ω) max.	IDC (mA) max.
0.2	$\pm 0.1, 0.2, 0.3nH$	13 / 500MHz	14	0.10	800
0.3	$\pm 0.1, 0.2, 0.3nH$	13 / 500MHz	14	0.10	800
0.4	$\pm 0.1, 0.2, 0.3nH$	13 / 500MHz	14	0.10	800
0.5	$\pm 0.1, 0.2, 0.3nH$	13 / 500MHz	14	0.15	700
0.6	$\pm 0.1, 0.2, 0.3nH$	13 / 500MHz	14	0.15	700
0.8	$\pm 0.1, 0.2, 0.3nH$	13 / 500MHz	14	0.15	700
0.9	$\pm 0.1, 0.2, 0.3nH$	13 / 500MHz	14	0.15	700
1.0	$\pm 0.1, 0.2, 0.3nH$	13 / 500MHz	12	0.15	700
1.1	$\pm 0.1, 0.2, 0.3nH$	13 / 500MHz	12	0.15	700
1.2	$\pm 0.1, 0.2, 0.3nH$	13 / 500MHz	12	0.15	700
1.3	$\pm 0.1, 0.2, 0.3nH$	13 / 500MHz	10	0.25	700
1.4	$\pm 0.1, 0.2, 0.3nH$	13 / 500MHz	10	0.25	700
1.5	$\pm 0.1, 0.2, 0.3nH$	13 / 500MHz	10	0.25	700
1.6	$\pm 0.1, 0.2, 0.3nH$	13 / 500MHz	10	0.25	560
1.7	$\pm 0.1, 0.2, 0.3nH$	13 / 500MHz	10	0.25	560
1.8	$\pm 0.1, 0.2, 0.3nH$	13 / 500MHz	10	0.25	560
1.9	$\pm 0.1, 0.2, 0.3nH$	13 / 500MHz	8	0.35	560
2.0	$\pm 0.1, 0.2, 0.3nH$	13 / 500MHz	8	0.35	560
2.1	$\pm 0.1, 0.2, 0.3nH$	13 / 500MHz	8	0.35	440
2.2	$\pm 0.1, 0.2, 0.3nH$	13 / 500MHz	8	0.35	440
2.3	$\pm 0.1, 0.2, 0.3nH$	13 / 500MHz	8	0.35	440
2.4	$\pm 0.1, 0.2, 0.3nH$	13 / 500MHz	8	0.35	440
2.5	$\pm 0.1, 0.2, 0.3nH$	13 / 500MHz	8	0.35	440
2.6	$\pm 0.1, 0.2, 0.3nH$	13 / 500MHz	8	0.35	440
2.7	$\pm 0.1, 0.2, 0.3nH$	13 / 500MHz	8	0.35	440
2.8	$\pm 0.1, 0.2, 0.3nH$	13 / 500MHz	6	0.45	380
2.9	$\pm 0.1, 0.2, 0.3nH$	13 / 500MHz	6	0.45	380
3.0	$\pm 0.1, 0.2, 0.3nH$	13 / 500MHz	6	0.45	380
3.1	$\pm 0.1, 0.2, 0.3nH$	13 / 500MHz	6	0.45	380
3.2	$\pm 0.1, 0.2, 0.3nH$	13 / 500MHz	6	0.45	380
3.3	$\pm 0.1, 0.2, 0.3nH$	13 / 500MHz	6	0.45	380
3.4	$\pm 0.1, 0.2, 0.3nH$	13 / 500MHz	6	0.55	380
3.5	$\pm 0.1, 0.2, 0.3nH$	13 / 500MHz	6	0.55	380
3.6	$\pm 0.1, 0.2, 0.3nH$	13 / 500MHz	6	0.55	380
3.7	$\pm 0.1, 0.2, 0.3nH$	13 / 500MHz	6	0.55	340
3.8	$\pm 0.1, 0.2, 0.3nH$	13 / 500MHz	6	0.55	340
3.9	$\pm 0.1, 0.2, 0.3nH$	13 / 500MHz	6	0.55	340
4.3	$\pm 0.1, 0.2, 0.3nH$	13 / 500MHz	6	0.65	320
4.7	$\pm 0.1, 0.2, 0.3nH$	13 / 500MHz	6	0.65	320
5.4	$\pm 0.1, 0.2, 0.3nH$	13 / 500MHz	6	0.85	280
5.6	$\pm 0.1, 0.2, 0.3nH$	13 / 500MHz	6	0.85	280
5.9	$\pm 0.1, 0.2, 0.3nH$	13 / 500MHz	6	0.85	280
6.5	$\pm 0.1, 0.2, 0.3nH$	13 / 500MHz	6	1.05	260
6.8	$\pm 0.1, 0.2, 0.3nH$	13 / 500MHz	6	1.05	260
7.2	$\pm 0.1, 0.2, 0.3nH$	13 / 500MHz	6	1.05	260
8.0	$\pm 0.1, 0.2, 0.3nH$	13 / 500MHz	5.5	1.25	220
8.1	$\pm 0.1, 0.2, 0.3nH$	13 / 500MHz	5.5	1.25	220
8.2	$\pm 0.1, 0.2, 0.3nH$	13 / 500MHz	5.5	1.25	220
9.1	$\pm 0.1, 0.2, 0.3nH$	13 / 500MHz	5.5	1.25	220
10.0	$\pm 1, 2, 3, 5\%$	13 / 500MHz	4.5	1.35	200
10.8	$\pm 1, 2, 3, 5\%$	13 / 500MHz	4.5	1.35	200
12.0	$\pm 1, 2, 3, 5\%$	13 / 500MHz	3.7	1.55	180
13.8	$\pm 1, 2, 3, 5\%$	13 / 500MHz	3.7	1.75	180
15.0	$\pm 1, 2, 3, 5\%$	13 / 500MHz	3.3	1.75	130
17.0	$\pm 1, 2, 3, 5\%$	13 / 500MHz	3.1	1.95	100
18.0	$\pm 1, 2, 3, 5\%$	13 / 500MHz	3.1	2.15	100
20.8	$\pm 1, 2, 3, 5\%$	13 / 500MHz	2.8	2.55	90
22.0	$\pm 1, 2, 3, 5\%$	13 / 500MHz	2.8	2.65	90
27.0	$\pm 1, 2, 3, 5\%$	13 / 500MHz	2.5	3.25	75
33.0	$\pm 5\%$	13 / 500MHz	2.5	4.50	75

AL03 Chip Inductors / Standard Type

Inductance (nH)	Inductance Tolerance (nH or %)	Quality Factor min.	SRF (GHz) min.	DCR (Ω) max.	IDC (mA) max.
1.0	$\pm 0.1, 0.2, 0.3\text{nH}$	15 / 300MHz	13	0.35	800
1.2	$\pm 0.1, 0.2, 0.3\text{nH}$	15 / 300MHz	13	0.35	800
1.5	$\pm 0.1, 0.2, 0.3\text{nH}$	15 / 300MHz	10	0.35	800
1.8	$\pm 0.1, 0.2, 0.3\text{nH}$	15 / 300MHz	10	0.35	300
2.2	$\pm 0.1, 0.2, 0.3\text{nH}$	15 / 300MHz	8	0.35	300
2.7	$\pm 0.1, 0.2, 0.3\text{nH}$	15 / 300MHz	6	0.45	300
3.3	$\pm 0.1, 0.2, 0.3\text{nH}$	15 / 300MHz	6	0.45	300
3.9	$\pm 0.1, 0.2, 0.3\text{nH}$	15 / 300MHz	6	0.45	300
4.7	$\pm 0.1, 0.2, 0.3\text{nH}$	15 / 300MHz	5	0.55	300
5.6	$\pm 0.1, 0.2, 0.3\text{nH}$	15 / 300MHz	5	0.65	300
6.8	$\pm 0.1, 0.2, 0.3\text{nH}$	15 / 300MHz	5	0.75	300
8.2	$\pm 0.1, 0.2, 0.3\text{nH}$	15 / 300MHz	4	0.95	300
10	$\pm 1, 2, 3, 5\%$	15 / 300MHz	4	0.95	300
12	$\pm 1, 2, 3, 5\%$	15 / 300MHz	3	1.05	300
15	$\pm 1, 2, 3, 5\%$	15 / 300MHz	3	1.35	300
18	$\pm 1, 2, 3, 5\%$	15 / 300MHz	2	1.65	300
22	$\pm 1, 2, 3, 5\%$	15 / 300MHz	2	1.95	250
27	$\pm 1, 2, 3, 5\%$	15 / 300MHz	2	2.35	250
33	$\pm 1, 2, 3, 5\%$	15 / 300MHz	1.5	2.75	250
39	$\pm 1, 2, 3, 5\%$	15 / 300MHz	1.5	3.00	200
47	$\pm 1, 2, 3, 5\%$	15 / 300MHz	1.5	3.00	200
56	$\pm 1, 2, 3, 5\%$	15 / 300MHz	1	5.00	150
68	$\pm 1, 2, 3, 5\%$	15 / 300MHz	1	5.00	150
100	$\pm 2, 3, 5\%$	15 / 300MHz	1	7.50	100

■ Environmental Characteristics

Item	Requirement	Test Method
Inductance	As Spec.	Measuring equipment and fixture: 0201: HP4287+Agilent 16196C 0402: HP4287+Agilent 16196B 0603: HP4287+Agilent 16196A
Insulation Resistance	>1000MΩ	MIL-STD-202 Method 302 Apply 100V _{DC} for 1minute
Damp Heat with Load	$\Delta L \leq 10\%$	MIL-STD-202 Method 103B 40±2°C, 90~95% R.H. Max. working voltage for 1000 hrs with 1.5 hrs "ON" and 0.5 hrs "OFF"
Bending Strength	As Spec.	JIS-C-5201-1 6.1.4 Bending Amplitude 3mm for 10 seconds
Solderability	95% min. coverage	MIL-STD-202 Method 208H 245±5°C for 3 seconds
Resistance to Soldering Heat	$\Delta L \leq 10\%$	MIL-STD-202 Method 210E 260±5°C for 10 seconds
Dielectric Withstand Voltage	>100V	MIL-STD-202 Method 301 Apply 100VA (rms) for 1minute
High Temperature Exposure	$\Delta L \leq 10\%$	JIS-C-5201-1 7.2 85±2°C, 1000 +48/-0 hours
Low Temperature Storage	$\Delta L \leq 10\%$	JIS-C-5201-1 7.1 -40±3°C, 1000 +48/-0 hours
Temperature Cycle	$\Delta L \leq 10\%$	JIS-C-5201-1 7.4 -40/RT/85/RT, 10 cycles

■ Storage Temperature: 25±3° C; Humidity < 80%RH

■ Reflow

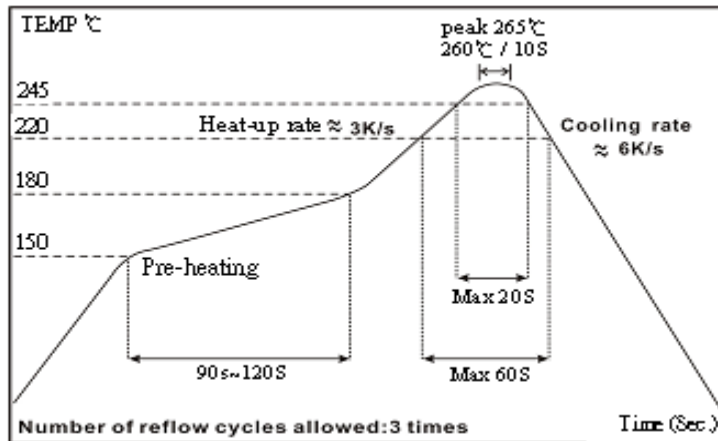

■Packaging

Reel Specifications & Packaging Quantity

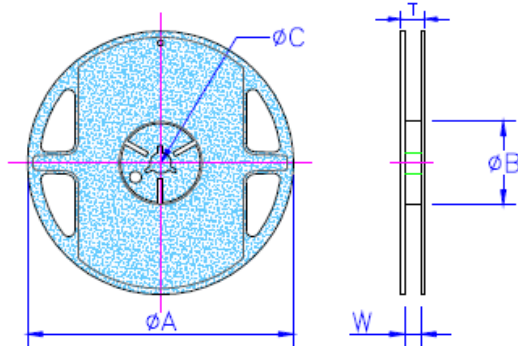

Type	ψA	ψB	ψC	W	T	Quantity (EA)
AL01	178±1.0	60.0±1.0	13.5±0.70	9.5±1.0	11.5±1.0	10,000
AL02	178±1.0	60.0±1.0	13.5±0.70	9.5±1.0	11.5±1.0	10,000
AL03	178±1.0	60.0±1.0	13.5±0.70	9.5±1.0	11.5±1.0	5,000

Unit: mm

Paper Tape Specifications

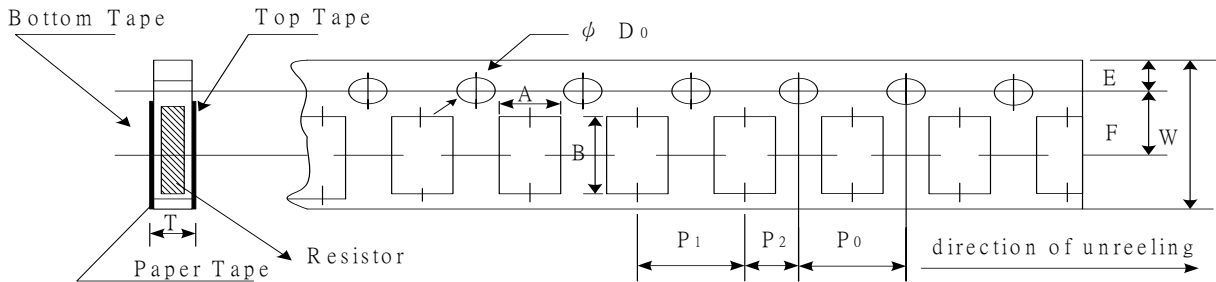

	A	B	W	E	F	P0	P1	P2	$\psi D0$	T
AL01	0.40±0.05	0.70±0.05	8.00±0.10	1.75±0.05	3.50±0.05	4.00±0.10	2.00±0.05	2.00±0.05	1.55±0.03	0.42±0.02
AL02	0.70±0.05	1.16±0.05	8.00±0.10	1.75±0.05	3.50±0.05	4.00±0.10	2.00±0.05	2.00±0.05	1.55±0.05	0.40±0.03
AL03	1.10±0.05	1.90±0.05	8.00±0.10	1.75±0.05	3.50±0.05	4.00±0.10	4.00±0.10	2.00±0.05	1.55±0.05	0.60±0.03

Unit: mm

Remark: Test Method

Test direction: bar mark faces left

■Recommend Land Pattern

Unit: mm

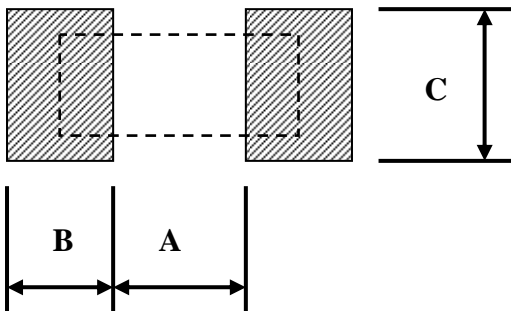

Type	A	B	C
AL01	0.30	0.25	0.30±0.2
AL02	0.50	0.45	0.60±0.2
AL03	0.90	0.60	0.90±0.2