



ENGLISH

Datasheet

7 way 5.08mm terminal block Plug

RS Stock number 790-0752



Dimensions: (mm)

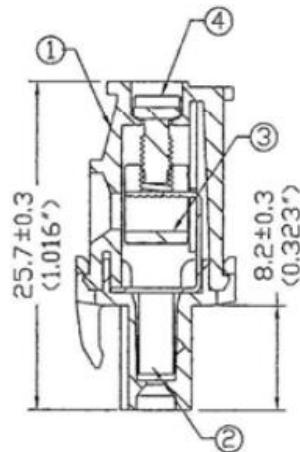
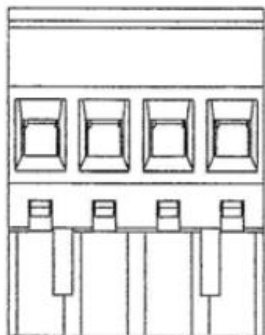
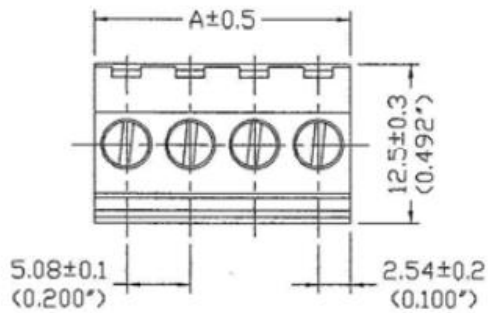



Specifications

- Current Rating: 16Amp AC300V
- Insulation withstands volts: AC2000V min
- Insulation resistance: > 2000 M Ω DC500V
- Operation Temperature: -40°C to +105°C
- Wire Strip Length: 7mm
- Wire Range: 12~24 AWG
- Screw Torque: 4.5 lb-inch

Material

- Insulating Body: Polyamide 66 (UL94V-0)
- Contact: Phosphor Bronze
- Cage Clamp: Brass
- Screw : Steel

Finish

- Insulating Body: Green
- Contact: Tin Plated
- Cage Clamp: NI Plated
- Screw: Ni Plated

- RoHS Compliant
- Lead Free

Pitch: 5.08mm (0.200inch)

poles	A(mm)	A(in)	Poles	A(mm)	A(in)
2	10.16	0.400	15	76.20	3.000
3	15.24	0.600	16	81.28	3.200
4	20.32	0.800	17	86.36	3.400
5	25.40	1.000	18	91.44	3.600
6	30.48	1.200	19	96.52	3.800
7	35.56	1.400	20	101.68	4.000
8	40.64	1.600	21	106.68	4.200
9	45.72	1.800	22	111.76	4.400
10	50.80	2.000	23	116.8	4.600
11	55.88	2.200	24	121.92	4.800
12	60.96	2.400			
13	66.04	2.600			
14	71.12	2.800			