

Datasheet

Platinum Resistance Pt100 Hygienic Thermometer, 1.5" RJT style fitting

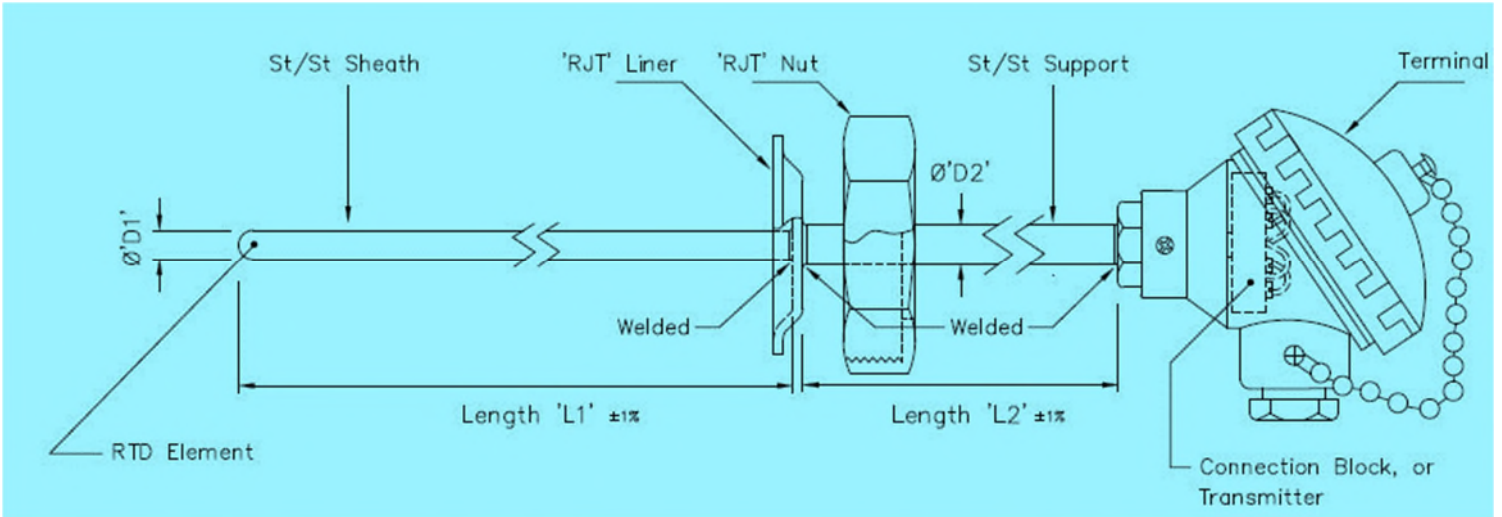

RJT unions (Ring Joint Type) are often referred to as a standard union. The compromise of an O-ring style gasket which leaves a small crevice where the liner and male part of the union overlap.

Ideal for hygienic processes including dairy, brewery and pharmaceutical applications.

Specification

- Sensor Type: Pt100, 3 or 4 wire single element class A
- Connection Type: RJT 316SS nut and liner
- Terminal Head: KNEF
- Transmitter: Optional SEM-203p transmitter, ranged -50°C to +150°C



Sensor Type	Sheath Diameter (D1)	Sheath Length (L1)	Support Diameter (D2)	Support Length (L2)	Transmitter Fitted	RS Order Code
Pt100, 4 wire	6.0mm	75mm	8.0mm	50mm	No	872-2764
Pt100, 4 wire	6.0mm	125mm	8.0mm	50mm	No	872-2767
Pt100, 3 wire	6.0mm	75mm	8.0mm	50mm	Yes	872-2761
Pt100, 3 wire	6.0mm	125mm	8.0mm	50mm	Yes	872-2770

Need RTD Cable or Pt100/Pt1000 Detectors?

RTD Extension Cable – 4 core (10 or 25 metre reel)

Platinum Resistance Thermometer Extension Cable – Silicone Rubber Insulated

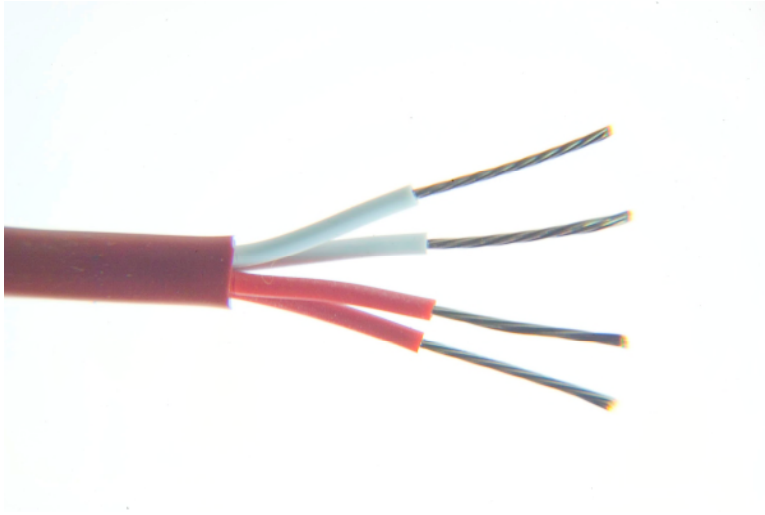

- Silicone rubber insulated cable for extending Platinum Resistance Thermometers
- Can be used to extend up to 4 wire RTD configurations
- Commonly used with Pt100Ω thermometers but suitable with other types Pt130/500/1000Ω etc.
- 4 core silicone rubber insulated 7/0.2mm tin plated copper conductors, twisted together with silicone rubber outer jacket
- Cores colour coded 2 x Red / 2 x White to IEC-751
- Good electrical and mechanical properties, highly flexible, resistant to oils, acids and other adverse fluids
- Good heat resistance up to 200°C
- Insulation rating -40°C to 200°C
- Supplied in 10 or 25 metre reel lengths

Type	Conductors	mm ²	Cores (4 core)	Jacket	Reel Length	Allied Code	RS order Code
RTD	7/0.2mm	0.219	2x Red / 2 x White	Brown	10 metres	70657147	827-5823
RTD	7/0.2mm	0.219	2x Red / 2 x White	Brown	25 metres	70644361	455-4242

Overall sheath Dimension (approx.)

4.0mmØ

RTD Extension Cable – 4 & 6 core PFA

Platinum Resistance Thermometer Extension Cable, PFA insulated & screened

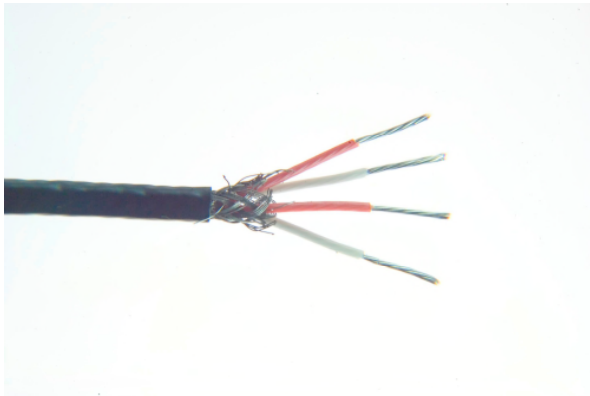

4 core (cores: 2 x red / 2 white)

6 core (cores: 4 x red / 2 x white)

- PFA insulated cable for extending Platinum Resistance Thermometers
- High temperature to 260°C, extruded PFA Teflon® construction
- Commonly used for Pt100Ω thermometers, also suitable with other types such as Pt130, Pt500 & Pt1000Ω
- 4 & 6 core available – to extend 2, 3 or 4 wire RTD configurations, the 6 core can be used to extend 2 x 3 wire duplex (dual element) configurations
- Construction – PFA insulated 7/0.2mm tin plated copper conductors, twisted cores with nylon cord, tin plated copper braided screen with PFA insulated outer jacket
- Cores colour coded Red & White in accordance with IEC-751, black outer jacket
- Good mechanical strength and flexibility, resistant to oils, acids and other adverse fluids
- Insulation rating -75°C to 260°C
- See below for available reel lengths

Type	Conductors	mm ²	Cores	Screen	Jacket	Reel Length	Allied Code	RS
RTD	7/0.2mm	0.219	x 4	Yes	Black	10 metres	70646175	611-8078
RTD	7/0.2mm	0.219	x 4	Yes	Black	25 metres	70646176	611-8090
RTD	7/0.2mm	0.219	x 4	Yes	Black	50 metres	70657148	827-5827
RTD	7/0.2mm	0.219	x 4	Yes	Black	100 metres	70657150	827-5836
RTD	7/0.2mm	0.219	x 6	Yes	Black	25 metres	70646177	611-8107
RTD	7/0.2mm	0.219	x 6	Yes	Black	50 metres	70657151	827-5839

Overall sheath Dimension (approx.)

4 core: 3.2mmØ
6 core: 3.8mmØ

RTD Extension Cable – 4 core PTFE (10 & 25 reel lengths)

Platinum Resistance Thermometer Extension Cable, PTFE insulated & screened

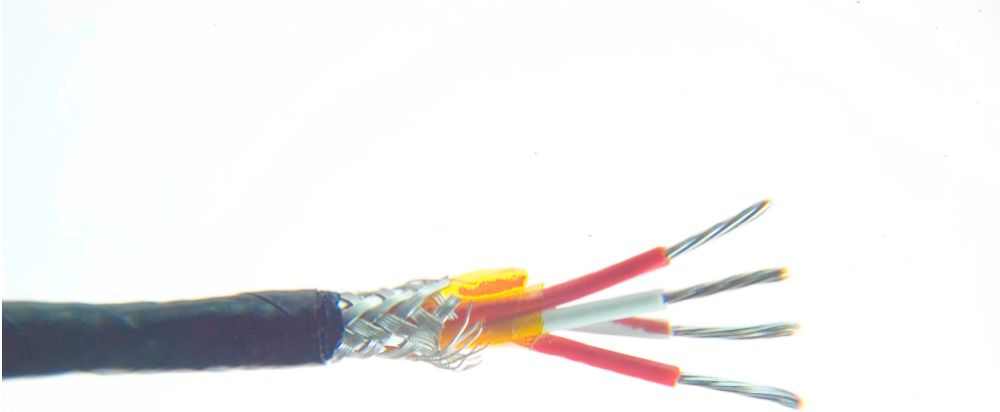

- PTFE insulated cable for extending Platinum Resistance Thermometers
- High temperature to 260°C, wrapped PTFE tape construction
- Can be used to extend 2, 3 or 4 wire RTD configurations
- Commonly used for Pt100Ω thermometers, also suitable with other types such as Pt130, Pt500 & Pt1000Ω
- 4 core PTFE insulated 7/0.2mm silver plated copper conductors, twisted cores, Mylar tape, silver plated copper braided screen with PTFE insulated outer jacket
- Cores colour coded 2 x Red / 2 x White to IEC-751 + black outer jacket
- Good mechanical strength and flexibility, resistant to oils, acids and other adverse fluids, steam, gasses etc.
- Insulation rating -75°C to 260°C
- Supplied in 10, & 25 metre reel lengths

Type	Conductors	mm ²	Cores (4 core)	Screen	Jacket	Reel Length	Allied Code	RS order code
RTD	7/0.2mm	0.219	2x Red/2x White	Yes	Black	10 metres	70644773	492-9775
RTD	7/0.2mm	0.219	2x Red/2x White	Yes	Black	25 metres	70642885	290-4976

Overall sheath Dimension (approx.)

3.5mmØ

RTD Extension Cable – 4 core PVC (10, 25 & 50 reel lengths)

Platinum Resistance Thermometer Extension Cable, PVC insulated & screened

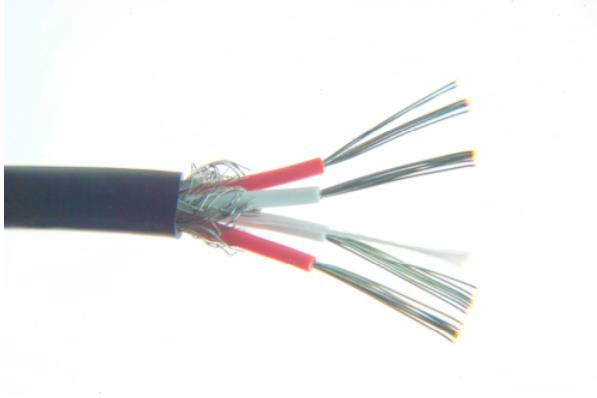

- PVC insulated cable for extending Platinum Resistance Thermometers
- Can be used to extend 2, 3 or 4 wire RTD configurations
- Commonly used for Pt100Ω thermometers but also suitable with other types such as Pt130, Pt500 & Pt1000Ω
- 4 core PVC insulated 7/0.2mm tin plated copper conductors, twisted cores, polyester tape & nylon cord, tin plated copper braided screen with PVC insulated outer jacket
- Cores colour coded 2 x Red / 2 x White to IEC-751 with black outer jacket
- Heat resistant PVC to 105°C
- Good for general purpose cable, highly flexible & waterproof
- Insulation rating -10°C to 105°C
- Supplied in 10, 25 & 50 metre reel lengths

Type	Conductors	mm ²	Cores (4 core)	Screen	Jacket	Reel Length	Allied Code	RS order code
RTD	7/0.2mm	0.219	2x Red/2x White	Yes	Black	10 metres	70644772	492-9753
RTD	7/0.2mm	0.219	2x Red/2x White	Yes	Black	25 metres	70642884	290-4954
RTD	7/0.2mm	0.219	2x Red/2x White	Yes	Black	50 metres	70646179	611-8129

Overall sheath Dimension (approx.)

4.4mmØ

Platinum Resistance Pt100 & Pt1000 Thin Film Detectors

Platinum Sensing Resistors – Thin Film (Pt100 & Pt1000 Ohm)

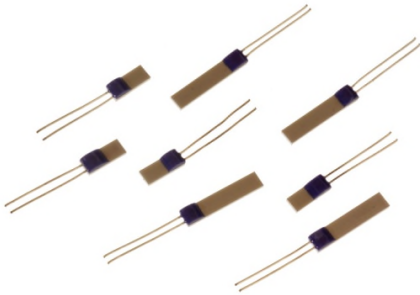

Pt100 Elements, Thin Film (100 Ohm)

- Pt100 elements to IEC751 Class A, B and 1/3DIN
- For use from -50°C to $+500^{\circ}\text{C}$
- Thin film construction
- Suitable for surface & immersion applications where protected
- Vibration resistant

Specifications:

Sensor type:	Pt100 (100 Ohms @ 0°C)
Construction:	Thin film, 10mm tails
Temperature range:	-50°C to $+500^{\circ}\text{C}$
Ice point resistance:	100 Ω
Fundamental interval (0°C to 100°C):	38.5 Ω (nominal)
Self-heating:	$<0.5^{\circ}\text{C}/\text{mW}$
Thermal response:	0.1s
Stability:	$\pm 0.05\%$

Resistance	Dimensions (width x length)	Tolerance Class	Allied code	RS order code
Pt100	2 x 5.0mm	Class A	70646146	611-7788
Pt100	2 x 5.0mm	Class B	70646148	611-7801
Pt100	2 x 5.0mm	Class B	70642888	290-5070 (Packet of 5)
Pt100	2 x 10mm	Class A	70643577	362-9799
Pt100	2 x 10mm	Class B	70641762	237-1607
Pt100	2.0 x 10mm	1/3DIN	70643578	362-9812
Pt100	2.0 x 2.3mm	Class A	70643579	362-9834
Pt100	2.0 x 2.3mm	Class B	70643580	362-9840
Pt100	2.0 x 2.3mm	1/3DIN	70643581	362-9856

Pt100 Elements (continued)

Resistance	Dimensions (width x length)	Tolerance Class	Allied code	RS order code
Pt100	1.2 x 1.6mm	Class A	70646834	666-7362
Pt100	1.2 x 1.6mm	Class B	70646831	666-7353

Pt100	1.0 x 3.0mm	Class A	70646833	666-7359
Pt100	1.0 x 3.0mm	Class B	70646832	666-7356
Pt100	2.0 x 5.0mm	1/3 Din	70656467	814-0162
Pt100	1.2 x 4.0mm	Class B	70656468	814-0165
Pt100	1.2 x 4.0mm	Class A	70656469	814-0169

Pt1000 Elements, Thin Film (1000 Ohm)

- Pt1000 elements to IEC 751 Class A and B
- For use from -50°C to +500°C
- Thin film construction
- Suitable for surface & immersion applications where protected
- Vibration resistant

Specifications:

Sensor type:	Pt1000 (1000 Ohms @0°C)
Construction:	Thin film, 10mm tails
Temperature range:	-50°C to +500°C
Ice point resistance:	1000Ω
Fundamental interval (0°C to 100°C):	385Ω (nominal)
Self-heating:	<0.5oC/mW
Thermal response:	0.1s
Stability:	±0.05%

Resistance	Dimensions (width x length)	Tolerance Class	Allied code	RS order code
Pt1000	2.0 x 10.0mm	Class A	70643582	362-9907
Pt1000	2.0 x 10.0mm	Class B	70643583	362-9913
Pt1000	2.0 x 10.0mm	1/3 Din	70656472	814-0178
Pt1000	1.0 x 3.0mm	Class B	70656470	814-0171
Pt1000	1.25 x 1.7mm	Class B	70656471	814-0175

Resistance Pt100 Wire-Wound Detector Elements

Pt100 platinum resistance thermometer elements in a choice of sizes – single & dual element

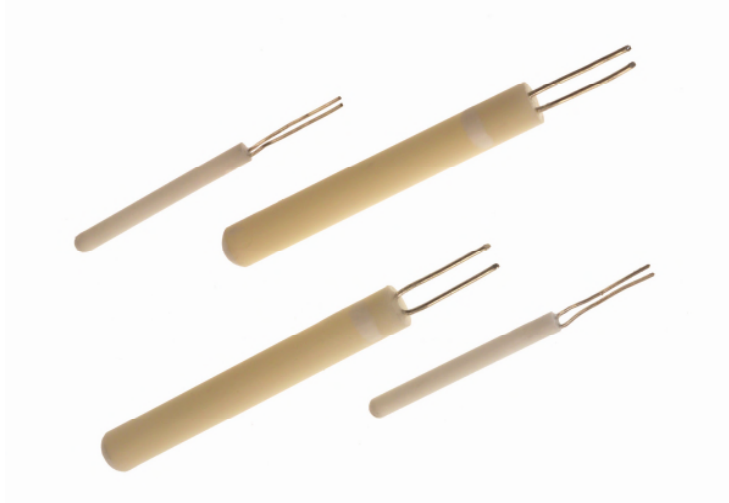

- Pt100 elements to IEC 60751 Class A or B
- 100 Ω Ohms @ 0°C
- Single or dual element
- Platinum coil wire-wound construction sealed inside a high purity alumina ceramic body
- Optimum performance & stability
- Temperature range –200°C to +650°C

Specifications:

Sensor type:	Pt100 (100 Ohms @ 0°C)
Construction:	Wire-Wound, 10mm tails
Temperature range:	-200°C to +650°C
Ice point resistance:	100 Ω
Fundamental interval (0°C to 100°C):	38.5 Ω (nominal)
Self-heating:	0.02 to 0.3°C/mW
Thermal response:	<0.4s (secs. to 63% of final value – in water @ 1m/s)
Measuring current:	1mA
Tolerance Class:	In accordance with IEC 60751 W0.15 (Class A) -100°C to +450°C W0.3 (Class B) -196°C to +660°C

Continued:

Single element:

Resistance	Tolerance Class	Diameter ('D')	Length ('L')	Allied code	RS order code
Pt100	Class B	1.5mm	8mm	70646153	611-7851
Pt100	Class A	1.5mm	8mm	70646155	611-7873
Pt100	Class B	1.5mm	15mm	70646154	611-7867
Pt100	Class A	1.5mm	15mm	70646151	611-7839
Pt100	Class B	2.8mm	15mm	70646150	611-7823
Pt100	Class A	2.8mm	15mm	70646152	611-7845
Pt100	Class B	2.8mm	25mm	70646147	611-7794
Pt100	Class A	2.8mm	25mm	70646149	611-7817

Dual element:

Pt100 (x2)	Class A	1.5mm	15mm	70643873	397-1595
------------	---------	-------	------	----------	-----------------

