



ENGLISH

**Datasheet**

# RS PRO POWER SUPPLY CORD

Stock No: 1230945



# CONTENT

1. Finished Production Drawing
2. Plug Drawing
3. Connector Drawing
4. Product Specification
5. Characteristic
6. Safety Certification



MARKING:

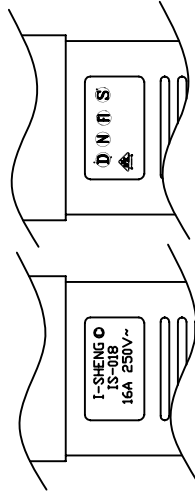

MARKING:

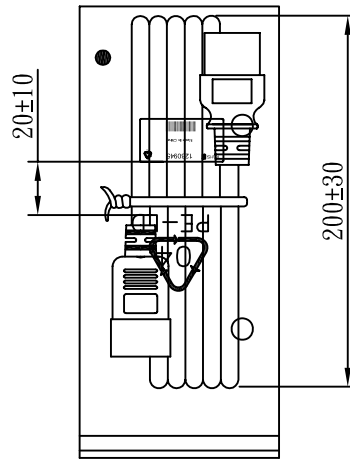
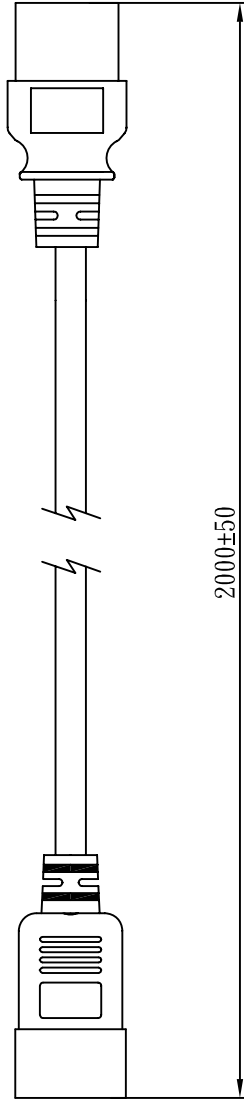
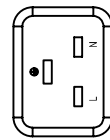
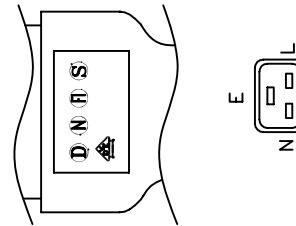
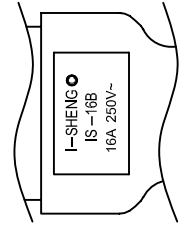

WIRING COLOR:

- E: Yellow/Green
- N: Blue
- L: Brown

LENGED ON CORD: (206-14)

I-SHENG SGIS <VDE> KEMA-KEUR  $\text{UL}$  CECC 809  $\text{S}$   $\text{D}$   $\text{N}$   $\text{E}$   
 NF-USE 1346 IEMMEQU H05VV-F 3G 1.5mm<sup>2</sup> 60227 IEC 53 RVV 300/500V  $\text{CC}$   
 A003083 3ASL/150 4V-75 V-75 (75°C) 250/440V ORDINARY DUTY Q96257 -LF- $\text{CE}$

No	BOM ITEM	Q'TY	P/N
1	97606-1 TERMINAL	2 pcs	BBN97606
2	97607-1 TERMINAL	1 pcs	BBN97607
3	IS-018 INNER BODY(YM-C20) RED	1 pcs	
4	PVC 45P (SA87, IS-018)	30 g	RPP045XF
5	98739PS-0 BLADE	3 pcs	BBP98739
6	IS-16 INNER BODY(YM-C19) RED	1 set	
7	PVC 45P (SA87, IS-16B)	30 g	RPP045XF
8	PE TIE (WHITE, 8 inch)	1 pcs	KBW10008
9	PE BAG	1 pcs	KPRI1000
10	LABEL	1 pcs	

Note: The secondCode: Code EAN-128C  
 Read the content : 1230945

Client P/N

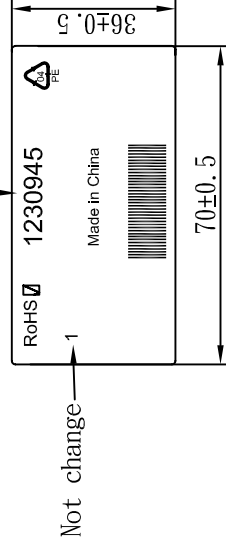

CABLE	H05VV-F 3G 1.5 DENT PRINT CT-XF(RED)		
PLUG	IS-018 + IS-16B	LENGTH	2000
NAME	First connectivity	N/W	
P/N	1230945	SG DWG	SR-162520-11 VER. A
	I-SHENG MANUFACTURING (SONG GANG) FACTORY		Design. by 倪雪平 2016.7.22
	鎰勝電子(深圳)有限公司		Review. by 朱曉玲 2016.7.22
			Approval. by 周德云 2016.7.22
X8B 6E3016 XF		200	01

Sample Drawing

FORM:END-22

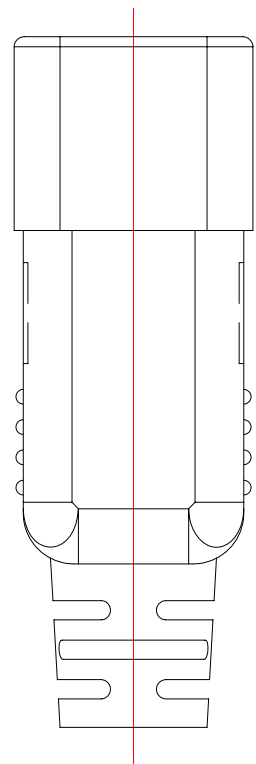
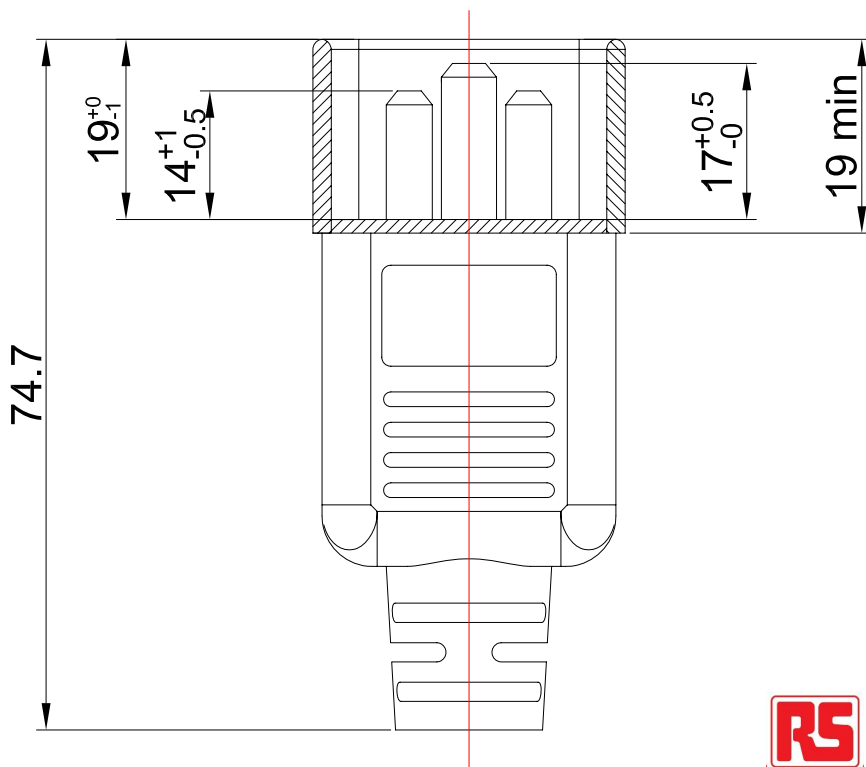
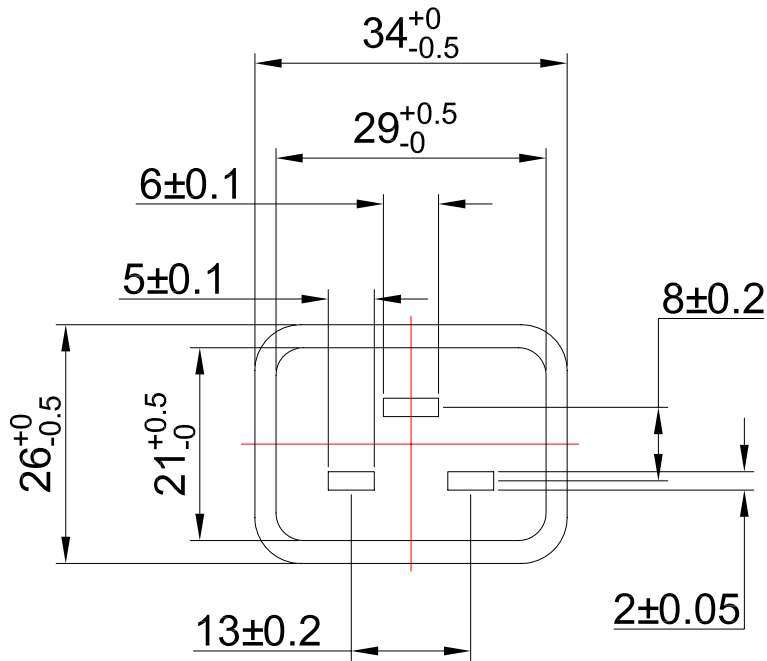

DWG. NAME	TYPE AND DIMENSIONS			TOLERANCE	
APPLY TO STANDARD	UNIVERSAL APPROVAL POWER SUPPLY CORD				
ISSUE DATE	2010/03/10	REV.	A	≤ 1.0	±0.3
REVISE DATE		UNIT	mm		
TYPE	IS-018	DWG. NO.	L18	≤ 10.0	±0.5
WIRE	SJT 14AWGx3C, H05VV-F 3X1.5				
 <b>I-SHENG ELECTRIC WIRE &amp; CABLE CO.,LTD.</b> 鎰勝工業股份有限公司	DESIGN BY	FANNY WANG		≤ 20.0	±1.0
	REVIEW BY	GERRY LAI			
	APPROVE BY	RYAN LAI		> 20.0	±2.0

# MARKING

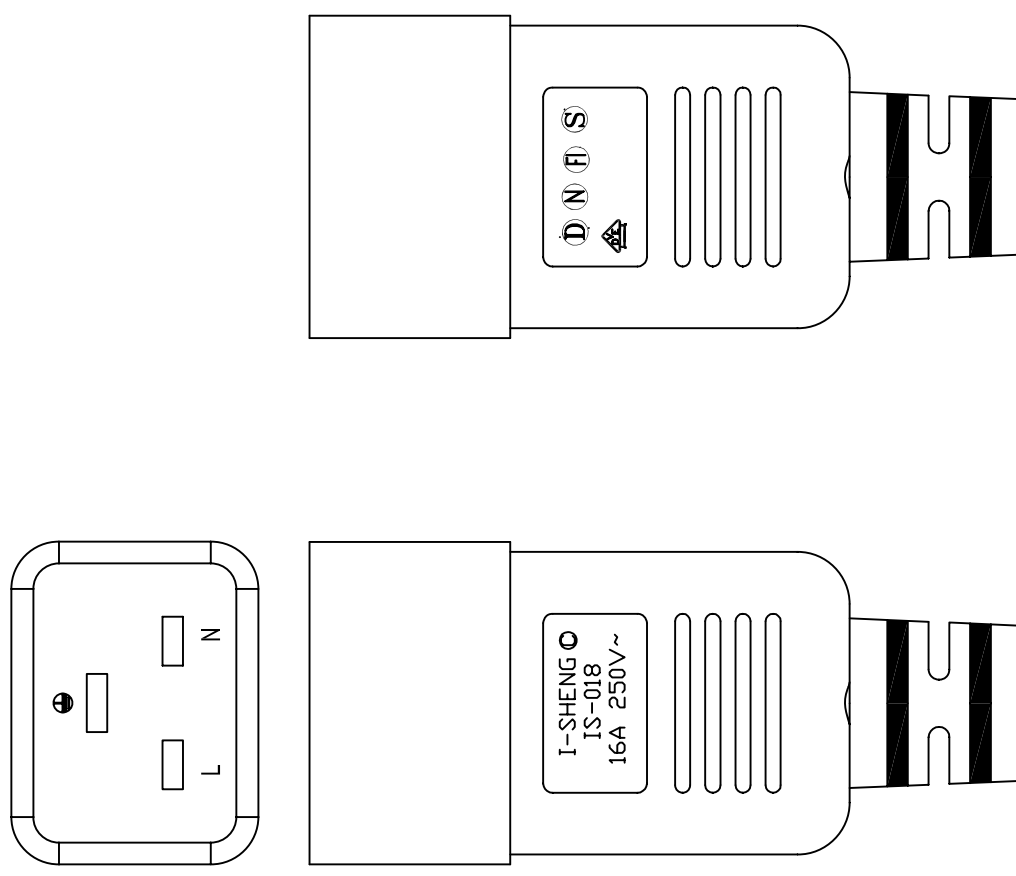
ISSUE 2008.10.06	STD. NAME UNIVERSAL APPROVAL POWER SUPPLY CORD	FILE NO. L18-01-1
REVISED C	CAT NO. IS-018 成品標識示意圖	PAGE 1
		



I-SHENG

D. by

NI

C. by

BOBOAN

A. by

YUN

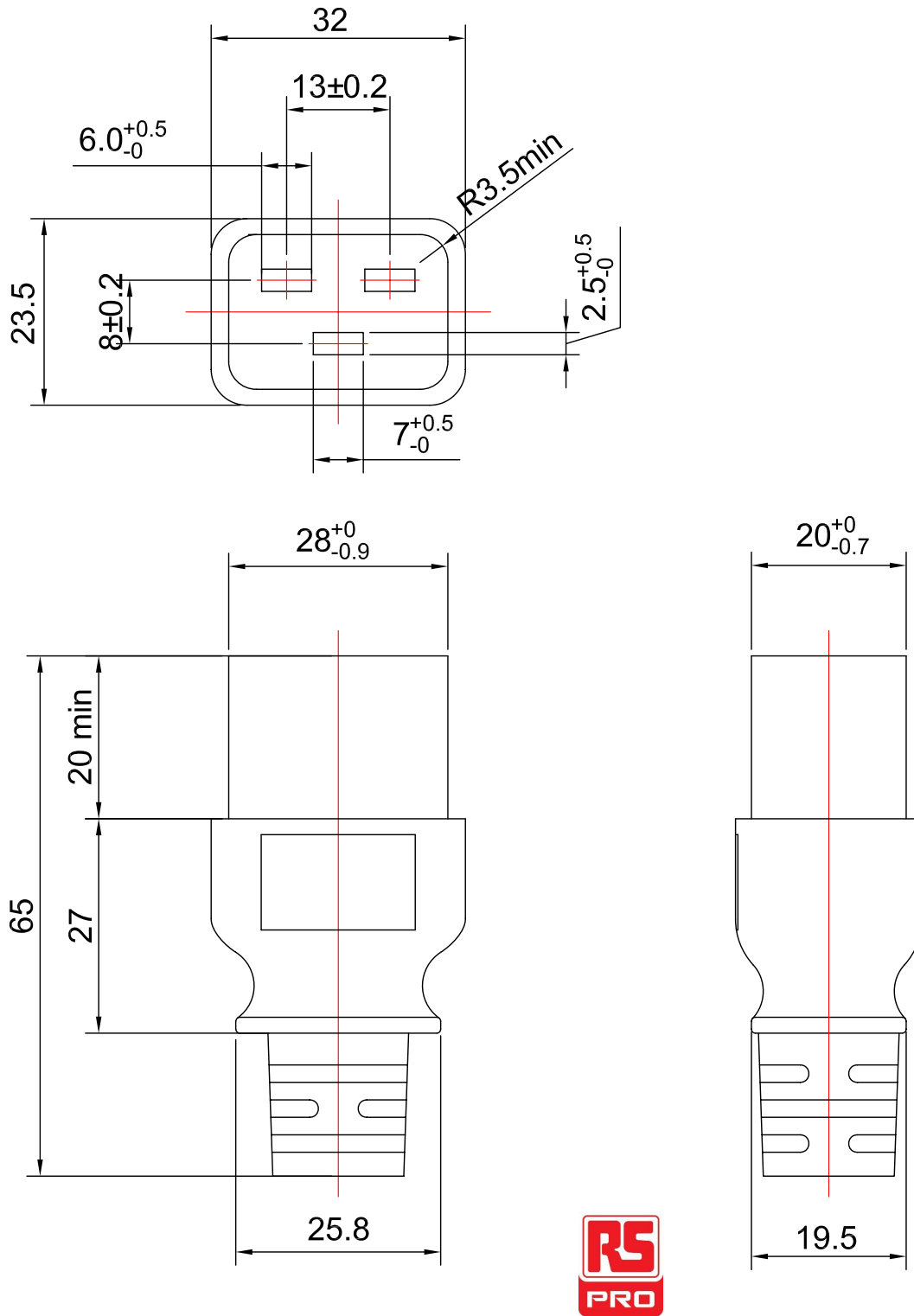

DWG. NAME	TYPE AND DIMENSIONS			<b>TOLERANCE</b>	
APPLY TO STANDARD	UNIVERSAL APPROVAL POWER SUPPLY CORD				
ISSUE DATE	2008.03.13	REV.	A	≤ 1.0	±0.3
REVISE DATE		UNIT	mm	≤ 10.0	±0.5
TYPE	IS-16B	DWG. NO.	L16B	≤ 20.0	±1.0
WIRE	SJT 14AWGx3C			> 20.0	±2.0
 <b>I-SHENG ELECTRIC</b> <b>WIRE &amp; CABLE CO.,LTD.</b> 鎰勝工業股份有限公司	DESIGN BY	FANNY WANG			
	REVIEW BY	GERRY LAI			
	APPROVE BY	RYAN LAI			

# MARKING

ISSUE 2008.07.15	STD. NAME UNIVERSAL APPROVAL POWER SUPPLY CORD	FILE NO. L6B-01-1
REVISED A	CAT NO. IS-16B 成品標識示意圖	PAGE 1

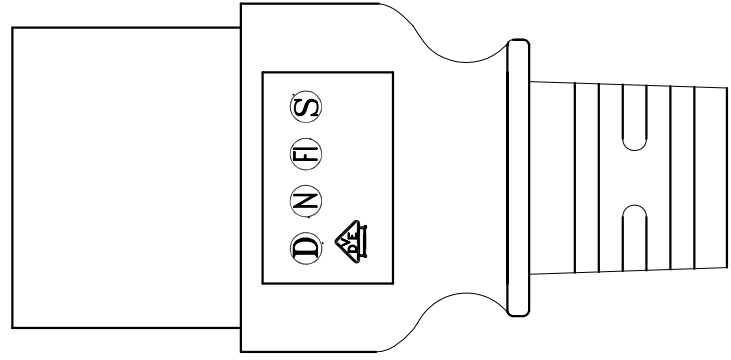
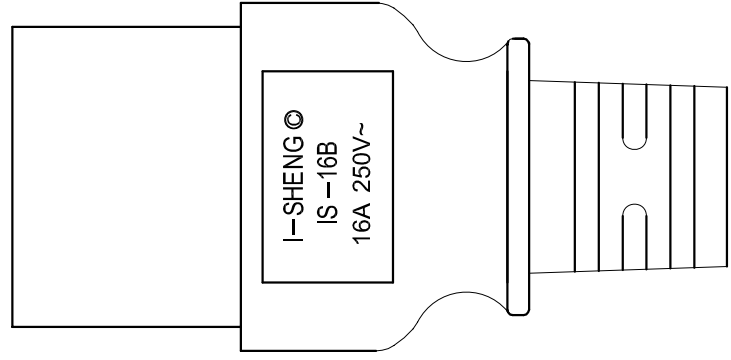
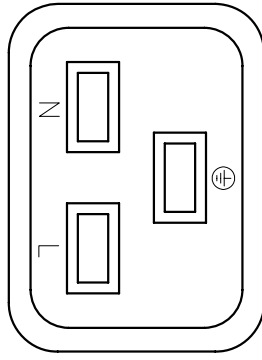

I-SHENG

D. by

NI

C. by

BOBOAN

A. by

YUN

# SPECIFICATION

Rev. 1.0

Issued	2013/2/22	Description	File No.	X8B6E3016
Revised		IS-018+IS-16B H05VV-F 3G 1.5mm <sup>2</sup>	Page	1/1

1. Scope :

This specification is applied to power supply cord conforming to:  
IEC 60227 IEC 60320-2-2 IEC 60320-1

2. Construction and dimensions:

In accordance with the following tables and attached drawings.

Item	Cat. No.	Rating		Approved No.
		A	V	
Plug	IS-018	16	250	As attachment
Connector	IS-16B	16	250	As attachment

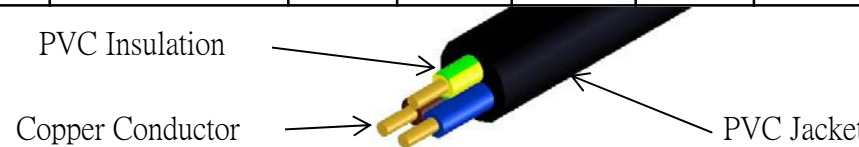
Flexible cord					H05VV-F 3G 1.5mm <sup>2</sup>			
Approved No.					As attachment			
Rating					300/500V 70°C			
Conductor		Insulation			Jacket			Conductor Resistance
Nominal (mm <sup>2</sup> )	Composition (pcs/mm)	Avg. Thickness (mm)	Min Thickness (mm)	Diameter (mm)	Avg. Thickness (mm)	Min Thickness (mm)	Diameter	Max 13.3Ω/km at 20°C In case of dispute, Conductor resistance shall be the referee method.
1.5	48/ § 0.20+0,-0.015	0.7	0.53	§ 3.1±0.1	0.9	0.67	§ 8.5±0.2	
								Insulation Color
								Blue
								Brown
								Yellow/Green

3. Cable marking on the sheath:

Shenzhen:  
I-SHENG SGIS <VDE>KEMA-KEUR <VE> △CEBEC 809 NF-USE 1346 IEMMEQU  
H05VV-F 3G 1.5mm<sup>2</sup> 60227 IEC 53 RVV 300/500V A003083 3ASL/150 4V-75 V-75(75°C) 250/440V  
ORDINARY DUTY Q96257 -LF- CE

Kunshan:  
I-SHENG KSIS <VDE>KEMA-KEUR <VE> △CEBEC 809 NF-USE 1353 IEMMEQU  
H05VV-F 3G 1.5mm<sup>2</sup> 60227 IEC 53 RVV 300/500V A041481 3ASL/150 4V-75 V-75(75°C) 250/440V  
ORDINARY DUTY Q96257 -LF- CE



發行 ISSUED 2000.03.05	標準名稱 STD.NAME	SPECIFICATION	檔案編號 FILE NO
修訂 REVISED 2010.05.24	題目 TITLE	THE CHARACTERISTIC OF POWER SUPPLY CORD FOR EUROPE	SPEC-EU

Items 項目		Conditions 條件		Specification 規格
1	Insulation resistance 絕緣抵抗	The insulation resistance is measured with a d.c. voltage of approximately 500 V, the measurement being made 1 min after application of the voltage.	Between all poles connected together and the body.  Between each pole in turn and all others, these being connected to the body.	The insulation resistance shall be not less than 100 MΩ.
2	Electric strength 耐電壓	Testing transformer capacity (耐壓計容量) :500 VA or more Trip current(遮斷電流) :2mA frequency(周波數) :50/60 Hz Test time:1Min	Between each contact in turn and the others connected together. <u>2800V</u> /1min.  Between the current-carrying contacts connected together and the body. <u>4000 V</u> /1 min.	No flashover or breakdown shall occur during the test.
3	Moisture resistance 耐濕性	The humidity treatment is carried out in a humidity cabinet containing air with a relative humidity maintained between 91% and 95%. The temperature of the air, at all places where specimens can be located, is maintained within $\pm 1^{\circ}\text{C}$ of any convenient value $t^{\circ}\text{C}$ between $20^{\circ}\text{C}$ and $30^{\circ}\text{C}$ .  Before being placed in the humidity cabinet, the specimens are brought to a temperature between $t^{\circ}\text{C}$ and $(t+4)^{\circ}\text{C}$ .  The specimens are kept in the cabinet for - 168h (7 days) for connector with earthing contact and for appliance inlets with earthing contact, which are submitted as individual accessories, not incorporated in other equipment.		After this treatment, the specimen shall show no damage.
4	Polarity/Continuity	Line and neutral shall be test at 24V; shall be instantaneous		Without breakdown

發行 ISSUED 2000.03.05	標準名稱 STD.NAME	SPECIFICATION	檔案編號 FILE NO
修訂 REVISED 2010.05.24	題目 TITLE	THE CHARACTERISTIC OF POWER SUPPLY CORD FOR EUROPE	SPEC-EU

Items 項目	Conditions 條件	Specification 規格	Items 項目																		
5 Flexing test 屈曲強度	<p>The oscillating member is moved through an angle of 90° (45° on either side of the vertical), the number of flexings being 10,000 and the rate of flexing 60/min.</p> <p>Specimens with circular section flexible cables are turned through 90° in the oscillating member after 5 000 flexings; specimens with flat flexible cables are only bent in a direction perpendicular to the plane containing the axes of the conductors.</p>		no interruption of the current, no short circuit between conductors.																		
		<table border="1"> <thead> <tr> <th></th> <th>Load Weight (g)</th> <th>Angle <math>\theta(^{\circ})</math></th> <th>Optional direction (turns)</th> <th>Furthermore 90° rotational direction (turns)</th> <th>Rate of flexing per min (turns)</th> </tr> </thead> <tbody> <tr> <td>plug</td> <td>0.75mm<sup>2</sup>↓ 1020(10N) 1.0mm<sup>2</sup>↑ 2040(20N)</td> <td>45</td> <td>10000</td> <td>5000</td> <td>60</td> </tr> <tr> <td>connector</td> <td>0.75mm<sup>2</sup>↓ 1020(10N) 1.0mm<sup>2</sup>↑ 2040(20N)</td> <td>45</td> <td>20000</td> <td>10000</td> <td>60</td> </tr> </tbody> </table>			Load Weight (g)	Angle $\theta(^{\circ})$	Optional direction (turns)	Furthermore 90° rotational direction (turns)	Rate of flexing per min (turns)	plug	0.75mm <sup>2</sup> ↓ 1020(10N) 1.0mm <sup>2</sup> ↑ 2040(20N)	45	10000	5000	60	connector	0.75mm <sup>2</sup> ↓ 1020(10N) 1.0mm <sup>2</sup> ↑ 2040(20N)	45	20000	10000	60
		Load Weight (g)		Angle $\theta(^{\circ})$	Optional direction (turns)	Furthermore 90° rotational direction (turns)	Rate of flexing per min (turns)														
plug	0.75mm <sup>2</sup> ↓ 1020(10N) 1.0mm <sup>2</sup> ↑ 2040(20N)	45	10000	5000	60																
connector	0.75mm <sup>2</sup> ↓ 1020(10N) 1.0mm <sup>2</sup> ↑ 2040(20N)	45	20000	10000	60																
<p style="text-align: right;">IEC 1332/02</p>																					

發行 ISSUED 2000.03.05	標準名稱 STD.NAME	SPECIFICATION	檔案編號 FILE NO
修訂 REVISED 2010.05.24	題目 TITLE	THE CHARACTERISTIC OF POWER SUPPLY CORD FOR EUROPE	SPEC-EU

Items 項目	Conditions 條件	Specification 規格
6 Breaking capacity 啓斷容量	<p>The connector and appliance inlet are connected and disconnected 50 times (100 strokes) at a rate of 30 strokes per minute. The length of a stroke of the test apparatus is between 50mm and 60mm.</p> <p>The periods during which the test current is passed from the connection to the subsequent disconnection of the accessories are 1.5(+0.5,-0)s.</p> <p>The test voltage is 275V, the test current is 1.25 times rated current and the power factor is at least 0.95 for 10A and 16A connectors and 0.6±0.05 for other connectors</p>	The specimen shall show no damage impairing its further use and the entry holes for the pins shall not show any serious damage.
7 Normal Operation 正常操作	<p>0,2 A connectors and the appliance inlet are connected and disconnected 2 000 times (4 000 strokes) without current flowing.</p> <p>Other connectors and the appliance inlet are connected and disconnected 1 000 times (2 000 strokes) at rated current and 3 000 times (6 000 strokes) without current flowing.</p>	No damage; The specimen can withstand the electric strength test with the voltage of 1500V.
8 Temperature rise 溫昇	<p>An alternating current of 1.25 times rated current is passed through the current-carrying contacts for 1h.</p> <p>For connectors with earthing contact, the current is then passed through one current-carrying contact and the earthing contact for 1h</p>	The temperature rise of pins, terminals and contacts shall not exceed 45k.

發行 ISSUED 2000.03.05	標準名稱 STD.NAME	SPECIFICATION	檔案編號 FILE NO
修訂 REVISED 2010.05.24	題目 TITLE	THE CHARACTERISTIC OF POWER SUPPLY CORD FOR EUROPE	SPEC-EU

9	Withdrawal force 引拔力	<p>Verification of the maximum withdrawal force The connector is inserted to the full depth into and withdrawn from the appropriate appliance inlet 10 times. It is then again inserted for a principal mass is such that it exerts a force equal to one-tenth of the maximum withdrawal force specified in the table and it shall be made in one piece and a supplementary.</p> <p>Verification of the minimum withdrawal force The test pin gauge is applied to each individual connector contact with the contact axes vertical and the gauge hanging vertically downwards. The total mass of the gauge shall be such as to exert the applicable force as show in table.</p> <table border="1" style="margin-left: auto; margin-right: auto;"> <thead> <tr> <th rowspan="3">Type of connector</th> <th colspan="3">Withdrawal force N ( kg )</th> </tr> <tr> <th colspan="2">Multi-pin gauge</th> <th rowspan="2">Single-pin gauge minimum</th> </tr> <tr> <th>Max</th> <th>Min</th> </tr> </thead> <tbody> <tr> <td>0.2A 2.5A 6A 10A</td> <td>50 ( 5.1 )</td> <td>10 ( 1.0 )</td> <td>1.5 ( 0.15 )</td> </tr> <tr> <td>16A</td> <td>60 ( 6.1 )</td> <td>15 ( 1.5 )</td> <td>2 ( 0.2 )</td> </tr> </tbody> </table>	Type of connector	Withdrawal force N ( kg )			Multi-pin gauge		Single-pin gauge minimum	Max	Min	0.2A 2.5A 6A 10A	50 ( 5.1 )	10 ( 1.0 )	1.5 ( 0.15 )	16A	60 ( 6.1 )	15 ( 1.5 )	2 ( 0.2 )	<p>After Verification of the maximum withdrawal force test. The principal mass is hung on the connector without jolting and the supplementary mass is allowed to fall from a height of 5 cm on to the principal mass. The connector shall not remain in the appliance inlet.</p> <p>After Verification of the minimum withdrawal force test. The test pin gauge is applied gently, and care is taken not to knock the assembly when checking the minimum withdrawal force. The gauge shall not fall from the contact assembly within 3 sec.</p>
Type of connector	Withdrawal force N ( kg )																			
	Multi-pin gauge			Single-pin gauge minimum																
	Max	Min																		
0.2A 2.5A 6A 10A	50 ( 5.1 )	10 ( 1.0 )	1.5 ( 0.15 )																	
16A	60 ( 6.1 )	15 ( 1.5 )	2 ( 0.2 )																	
10	Resistance to heat 耐熱試驗	<p>The test being made in a heating cabinet at a temperature of <math>100 \pm 2^{\circ}\text{C}</math>.</p> <p>The specimen is clamped between steel jaws, having a cylindrical face of 25mm radius, a width of 15mm and a length of 50mm. The corners are rounded with a radius of 2.5mm.</p> <p>The specimen is clamped in such a way that the jaws press against it in the area where it is gripped in normal use, the centre line of the jaws coinciding as nearly as possible with the centre of this area.</p> <p>The force applied through the jaws is 20N</p>	<p>After 1h, the jaws are removed and the specimen shall show no damage within the meaning of this standard.</p>																	

發行 ISSUED 2000.03.05	標準名稱 STD.NAME	SPECIFICATION	檔案編號 FILE NO
修訂 REVISED 2010.05.24	題目 TITLE	THE CHARACTERISTIC OF POWER SUPPLY CORD FOR EUROPE	SPEC-EU

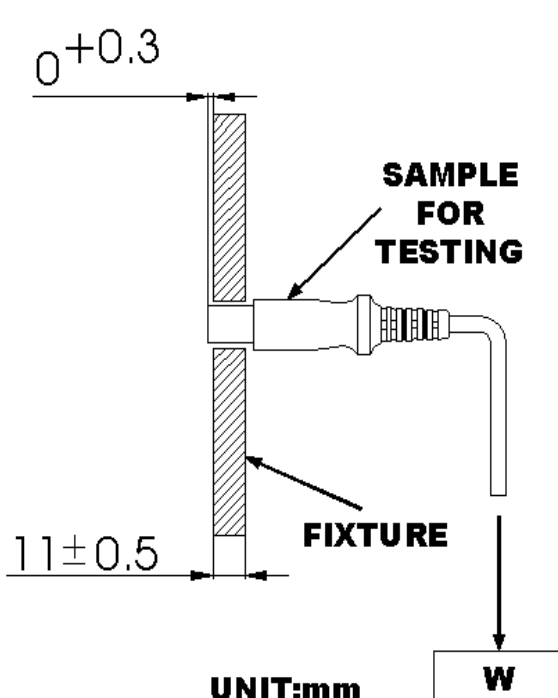
Items 項目	Conditions 條件	Specification 規格
11 Resistance to Aging 老化試驗	<p>The specimens are suspended freely in a heating cabinet, ventilated by natural circulation. They are kept in the cabinet, which is maintained at a temperature of <math>80 \pm 2^{\circ}\text{C}</math>, for 168h (7 days).</p> <p>After the test are allowed to attain approximately ambient temperature and are then examined.</p> <p>They shall show no crack visible to the naked eye, nor shall the material have become sticky or greasy, this being judged as follows.</p> <p>1) A forefinger wrapped in a dry piece of rough cloth is pressed on the specimen with a force of 5N. 2) No traces of the cloth shall remain on the specimen and the material of the specimen shall not stick to the cloth.</p>	After this test, the specimen shall show no damage which would lead to non-compliance with this standard.
12 Bending strength of connector body 本體機械強度	<p>After the connector's point is fixed as shown in the figure below. Load of 10kg shall be applied vertically and slowly for 15 s.</p>  <p style="text-align: center;">UNIT:mm</p>	After the test, the connector shall show no damage.

發行 ISSUED 2000.03.05	標準名稱 STD.NAME	SPECIFICATION	檔案編號 FILE NO
修訂 REVISED 2010.05.24	題目 TITLE	THE CHARACTERISTIC OF POWER SUPPLY CORD FOR EUROPE	SPEC-EU

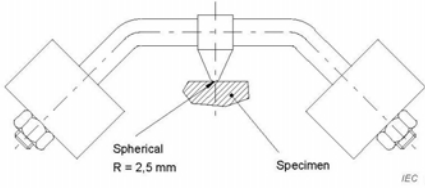
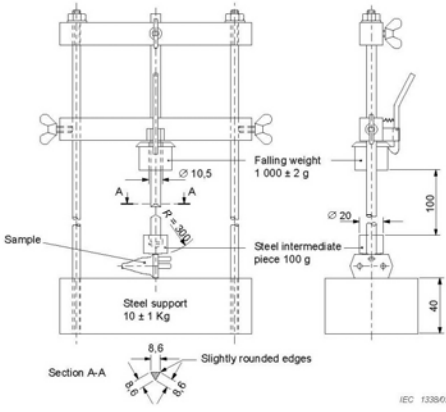
<p>13 Ball pressure test 球壓測試</p>	<p>The sample is 2 mm wide, surrounding the phase and neutral pin entry holes of socket-outlets, shall be subjected to a ball-pressure test.</p> <p>The part under test shall be placed on a steel plate at least 3 mm thick and in direct contact with it.</p> <p>The surface of the part to be tested is placed in the horizontal position and the hemispherical tip of the test equipment is pressed against the surface with a force of 20 N.</p> <p>The test is made in a heating cabinet at a temperature of <math>(125 \pm 2) ^\circ\text{C}</math> for 1h. After 1 h the ball shall be removed from the specimen, which is then immersed within 10 s, in cold water for cooling down to approximately room temperature.</p>  <p style="text-align: center;">Spherical R = 2.5 mm</p> <p style="text-align: center;">Specimen</p> <p style="text-align: right;">IEC 1348/02</p> <p style="text-align: center;"><i>Dimensions in millimetres</i></p>	<p>The diameter of the impression caused by the ball is measured and shall not exceed 2 mm.</p>
<p>14 Impact test at Low temperature 低溫撞擊測試</p>	<p>The apparatus, positioned on a pad of sponge rubber 40 mm thick, is placed together with the specimens in a freezer at a temperature of <math>(-15 \pm 2) ^\circ\text{C}</math>, for at least 16 h.</p> <p>At the end of this period, each specimen, in turn, is placed in the normal position of use as shown in the figure below, and a weight is allowed to fall from a height of 100 mm. The mass of the falling weight is <math>(1\ 000 \pm 2) \text{ g}</math>.</p>  <p style="text-align: center;">Falling weight 1 000 ± 2 g</p> <p style="text-align: center;">Steel intermediate piece 100 g</p> <p style="text-align: center;">Steel support 10 ± 1 Kg</p> <p style="text-align: center;">Sample</p> <p style="text-align: center;">Section A-A</p> <p style="text-align: center;">8.6</p> <p style="text-align: center;">Slightly rounded edges</p> <p style="text-align: right;">IEC 1338/02</p> <p style="text-align: center;"><i>Dimensions in millimetres</i></p>	<p>After the test, the specimen shall show no damage within the meaning of this standard.</p>

## ZEICHENGENEHMIGUNG MARKS APPROVAL

ist berechtigt, für ihr Produkt /  
*is authorized to use for their product*

**Geräteanschlußstecker, nichtwiederanschließbar**  
**Plug connector, non-rewirable**

die hier abgebildeten markenrechtlich geschützten Zeichen  
für die ab Blatt 2 aufgeführten Typen zu benutzen /  
*the legally protected Marks as shown below for the types referred to on page 2 ff.*



Gepprüft und zertifiziert nach /  
*Tested and certified according to*

DIN EN 60320-1 (VDE 0625-1):2008-05; EN 60320-1:2001 + A1:2007  
DIN EN 60320-2-2 (VDE 0625 Teil 2-2):1999-09; EN 60320-2-2:1998

VDE Prüf- und Zertifizierungsinstitut GmbH  
*VDE Testing and Certification Institute*  
Zertifizierungsstelle / *Certification*

VDE Zertifikate sind nur gültig bei Veröffentlichung unter:  
*VDE certificates are valid only when published on:*

Aktenzeichen: 1276300-1550-0804 / 119120

*File ref.:*

Ausweis-Nr. 40030043

*Certificate No.*

Blatt 1

*Page*

Weitere Bedingungen siehe Rückseite und Folgeblätter /  
*further conditions see overleaf and following pages*

Offenbach, 2010-05-10

Name und Sitz des Genehmigungs-Inhabers / *Name and registered seat of the Certificate holder*

Aktenzeichen / *File ref.*  
1276300-1550-0804 / 119120 / FG31 / E

Datum / *Date*  
2010-05-10

Dieses Blatt gilt nur in Verbindung mit Blatt 1 des Zeichengenehmigungsausweises Nr. 40030043.  
*This supplement is only valid in conjunction with page 1 of the Certificate No. 40030043.*

**Geräteanschlußstecker, nichtwiederanschließbar**  
**Plug connector, non-rewirable**

Typ(en) / *Type(s)*:

**IS-018**

Bemessungsspannung <i>Rated voltage</i>	AC 250 V
Bemessungsstrom <i>Rated current</i>	16 A
Polzahl <i>Number of poles</i>	2-polig mit Schutzkontakt <i>2-pole with earthing contact</i>
Bauart <i>Kind of construction</i>	Normblatt I <i>standard sheet I</i>
Kennzeichnung der Fertigungsstätte(n) <i>Marking of manufacturingplace(s)</i>	30006550: "C" 30006554: "K"
Produktinformation <i>Product information</i>	siehe Anlage Nr. 300 + 301 + 900 <i>see Appendix No. 300 + 301 + 900</i>

Dieser Zeichengenehmigungs-Ausweis bildet eine Grundlage für die EG-Konformitätserklärung und CE-Kennzeichnung durch den Hersteller oder dessen Bevollmächtigten und bescheinigt die Konformität mit den grundlegenden Schutzanforderungen der **EG-Niederspannungsrichtlinie 2006/95/EG** mit ihren Änderungen.

*This Marks Approval is a basis for the EC Declaration of Conformity and the CE Marking by the manufacturer or his agent and proves the conformity with the essential safety requirements of the **EC Low-Voltage Directive 2006/95/EC** including amendments.*

VDE Prüf- und Zertifizierungsinstitut GmbH  
*VDE Testing and Certification Institute*  
Fachgebiet FG31  
*Section FG31*



**VDE Prüf- und Zertifizierungsinstitut**  
**Zeichengenehmigung**

Ausweis-Nr. / Beiblatt /  
Certificate No. Supplement  
40030043

Name und Sitz des Genehmigungs-Inhabers / *Name and registered seat of the Certificate holder*

Aktenzeichen / *File ref.*  
1276300-1550-0804 / 119120 / FG31 / E

Datum / *Date*  
2010-05-10

Dieses Beiblatt ist Bestandteil des Zeichengenehmigungsausweises Nr. 40030043.  
*This supplement is part of the Certificate No. 40030043.*

**Geräteanschlußstecker, nichtwiederanschließbar**  
**Plug connector, non-rewirable**

**Fertigungsstätte(n)**  
**Place(s) of manufacture**

Referenz/*Reference*  
**30006550**

Referenz/*Reference*  
**30006554**

VDE Prüf- und Zertifizierungsinstitut GmbH  
*VDE Testing and Certification Institute*  
Fachgebiet FG31  
*Section FG31*

Name und Sitz des Genehmigungs-Inhabers / *Name and registered seat of the Certificate holder*

Aktenzeichen / *File ref.*  
1276300-1550-0804 / 119120 / FG31 / E

Datum / *Date*  
2010-05-10

Dieses Blatt gilt nur in Verbindung mit Blatt 1 des Zeichengenehmigungsausweises Nr. 40030043.  
*This supplement is only valid in conjunction with page 1 of the Certificate No. 40030043.*

**Genehmigung zum Benutzen des auf Seite 1 abgebildeten markenrechtlich geschützten Zeichens des VDE:**

Grundlage für die Benutzung sind die Allgemeinen Geschäftsbedingungen (AGB) des VDE Prüf- und Zertifizierungsinstitut GmbH. Das Recht zur Benutzung erstreckt sich nur auf die bezeichnete Firma mit den genannten Fertigungsstätten und die oben aufgeführten Produkte mit den zugeordneten Bezeichnungen. Die Fertigungsstätte muss so eingerichtet sein, dass eine gleichmäßige Herstellung der geprüften und zertifizierten Ausführung gewährleistet ist.

Die Genehmigung ist so lange gültig wie die VDE-Bestimmungen gelten, die der Zertifizierung zugrunde gelegen haben, sofern sie nicht auf Grund anderer Bedingungen aus der Prüf- und Zertifizierungsordnung (PM102) zurückgezogen werden muss.

Der Gültigkeitszeitraum einer VDE-GS-Zeichengenehmigung kann auf Antrag verlängert werden. Bei gesetzlichen und / oder normativen Änderungen kann die VDE-GS-Zeichengenehmigung ihre Gültigkeit zu einem früheren als dem angegebenen Datum verlieren.

Produkte, die das Biozid Dimethylfumarat (DMF) enthalten, dürfen gemäß der Kommissionsentscheidung 2009/251/EG nicht mehr in den Verkehr gebracht oder auf dem Markt bereitgestellt werden.

Der VDE-Zeichengenehmigungsausweis wird ausschließlich auf der ersten Seite unterzeichnet.

***Approval to use the legally protected Mark of the VDE as shown on the first page:***

*Basis for the use are the general terms and conditions of the VDE Testing and Certification Institute. The right to use the mark is granted only to the mentioned company with the named places of manufacture and the listed products with the related type references. The place of manufacture shall be equipped in a way that a constant manufacturing of the certified construction is assured.*

*The approval is valid as long as the VDE specifications are in force , on which the certification is based on, unless it is withdrawn according to Procedure (PM102).*

*The validity period of a VDE-GS-Mark Approval may be prolonged on request. In case of changes in legal and / or normative requirements, the validity period of a VDE-GS-Mark Approval may be shortened.*

Products containing the biocide dimethylfumarate (DMF) may not be marketed or made available on the EC market according to the Commission Decision 2009/251/EC.

*The approval is solely signed on the first page*

# DEMKO CERTIFICATE

**Certificate No.** D-03589  
**Page** 1/3  
**Date of Issue** 2014-08-26

**Certificate Holder**

**Manufacturer**

**Production site**

See Page 2

**Certified Product Model** Plug connector  
IS-018 with cord H07RN-F 3G1-1,5  
IS-018 with cord H05VV-F 3G1,5

**Trademark** I-SHENG

**Rated Voltage / Frequency** 250 V~

**Rated Current / Power** 16 A

**Insulation Class** -

**Degree of protection (IP)** 20

**Tested acc. to** EN 60320-1:2001/A1:2007, EN 60320-1:2001, EN 60320-2-2:1998

**Test Report No.** NCS/FI 28682 issued on 2014-08-15

**Additional** See Page 2

**Expire date** 2019-08-15

**Certification Manager**  
Jan-Erik Storgaard

This is to certify that representative sample(s) of the Product described herein ("Certified Product") have been investigated and found in compliance with the Standard(s) indicated on this Certificate, in accordance with the D Mark Requirements. The Designated Certificate holder is entitled to use the d or for cables <DEMKO> for the Certified Product manufactured at the production site(s) identified above, in accordance with the D Mark Service Agreement, including without limitation the D Mark Testing and Certification Services Service Terms. Only those Products bearing the D Mark should be considered as being covered by UL's D Mark Service. This Certificate shall remain valid through the expiration date, unless terminated earlier in accordance with the Service Agreement including without limitation if the Standard identified on this Certificate is amended or withdrawn prior the expiration date.

**Certification Body**

UL International Demko A/S, Borupvang 5A, DK-2750  
Ballerup, Denmark, Tel. +45 44 85 65 65,  
info.dk@ul.com  
www.ul-europe.com



# Appendix DEMKO CERTIFICATE

**Certificate No.** D-03589  
**Page** 2/3  
**Date of Issue** 2014-08-26

Production Sites:

External Certification Information:  
NCS/FI 28682, issued on 2014-08-15 by SGS Fimko Ltd.

Additional Information:  
Standard Sheet I

This certificate replaces previous DEMKO Certificate No. 311167-03, dated 2009-10-22 due to new testing and remove one manufacturing site.

---

**Certification Body**

UL International Demko A/S, Borupvang 5A, DK-2750  
Ballerup, Denmark, Tel. +45 44 85 65 65, info.dk@ul.com  
[www.ul-europe.com](http://www.ul-europe.com)



# Appendix DEMKO CERTIFICATE

Certificate No. D-03589  
Page 3/3  
Date of Issue 2014-08-26

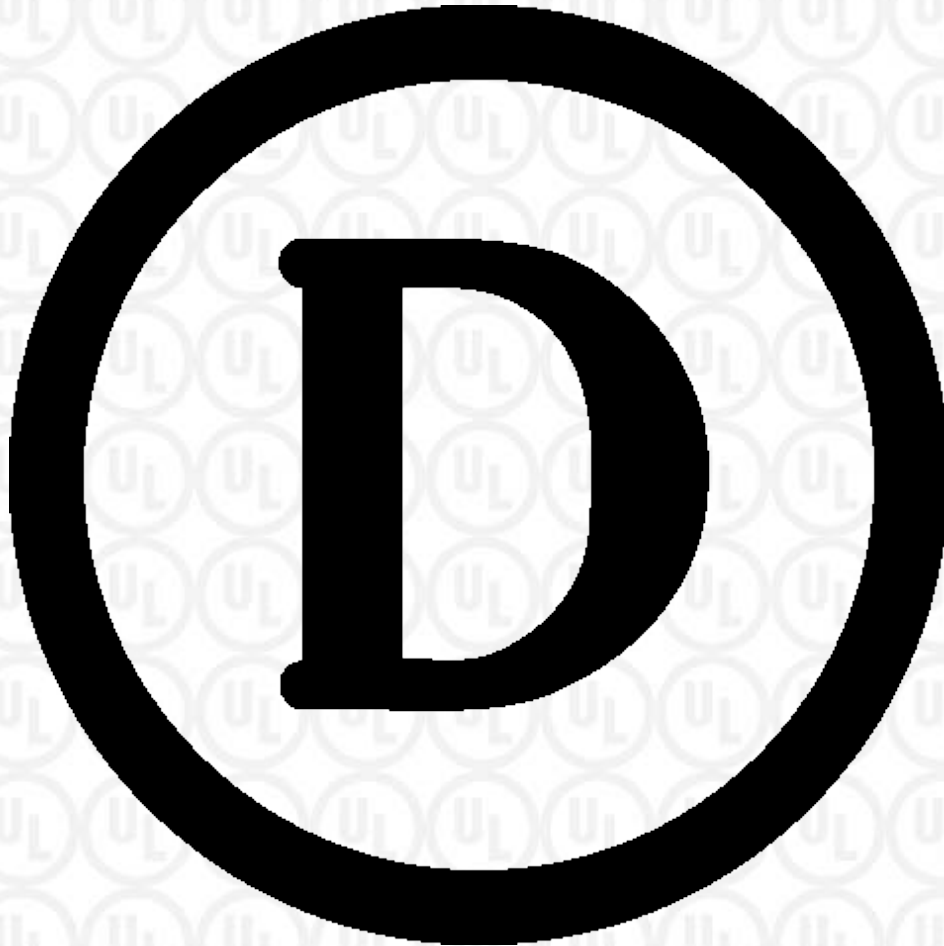

**Certification Body**

UL International Demko A/S, Borupvang 5A, DK-2750  
Ballerup, Denmark, Tel. +45 44 85 65 65, info.dk@ul.com  
www.ul-europe.com



# Certificate



Intertek

for European Product Safety

Reference No. 1410837

## Plug connector

Type designation	IS-018
Certificate holder	<b>I-Sheng Electric Wire &amp; Cable Co., Ltd.</b> <b>52, Tin Hwu Rd. Ta Gann Village, Gwai San Hsian</b> <b>33334 TAOYUAN HSIEN</b> <b>TAIWAN</b>
The product complies with the standard(s)	EN 60320-1:2001+A1 EN 60320-2-2:1998
Date of expiry	20 August 2019

Additional information in Appendix.

Certification Body Intertek Semko AB, Product Certification Place Kista - Stockholm

Signed

  
\_\_\_\_\_  
Paul Klemets

Date 20 August 2014  
Page 1 of 2

**Intertek  
Appendix**

Reference No. 1410837

*Technical data*

Type designation	IS-018
Rated voltage (V)	250 V~
Rated current (A)	16 A
IP-Class	20
Type of cord	H05VV-F 3G1.5 mm <sup>2</sup> H07RN-F 3G1-1.5 mm <sup>2</sup>
Standard sheet	I
Brand name:	I-SHENG

*Manufacturing site(s)*

The certificate applies for countries that have sanctioned the use of plugs/outlets according to subject standard sheet and component standard.

This certificate is based on a certificate with ref. No. NCS/FI 28682 dated 15 August 2014, issued by SGS Fimko Ltd according to the Nordic Certification Service Agreement.

*Certification Body* Intertek Semko AB, Product Certification *Place* Kista - Stockholm

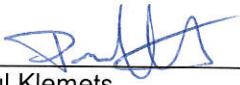
*Signed*   
Paul Klemets *Date* 20 August 2014

*This Certificate is for the exclusive use of Intertek's Client and is provided pursuant to the Certification agreement between Intertek and its Client. Intertek's responsibility and liability are limited to the terms and conditions of the agreement. Intertek assumes no liability to any party, other than to the Client in accordance with the agreement, for any loss, expense or damage occasioned by the use of this certificate. Only the Client is authorized to permit copying or distribution of this certificate and then only in its entirety. Use of Intertek's Certification mark is restricted to the conditions laid out in the agreement. Any further use of the Intertek name for the sale or advertisement of the tested material, product or service must first be approved in writing by Intertek. Initial Factory Assessments and Follow up Services are for the purpose of assuring appropriate usage of the Certification mark in accordance with the agreement, they are not for the purposes of production quality control and do not relieve the Client of their obligations in this respect.*

Product Plug connector

Applicant

Manufacturer

Factory

 See page 2

Ratings

16A 250V AC

Trade mark

Model / Type Ref.

IS-018

Principal characteristics

Plug connector for Class I equipment. Standard Sheet I.  
With cord H05VV-F 3G1.5mm<sup>2</sup>. IP20. See next page(s)A sample of the product was tested  
and found to be in conformity with

INST EN 60320-2-2:1998

Replaces

This certificate replaces previous certificate No. P02100025/A1, due to added  
cross-section and a new factory

Validity

This certificate documents conformity with the standards shown, and also applies as license for use  
of Nemkos name and certification mark. The certificate and license is valid as long as the  
applicable conditions are complied with, and provided that any changes to the product are notified  
to Nemko for acceptance prior to implementation.New standards or amendments to the standards may imply that the product design must be  
updated and/or that re-testing and re-certification is necessary.

Additional information

 See next page(s)

Additional model(s)

 See next page(s)

Date of issue 25-08-2009



Signature

Terje Ulsrud

Certification Department

Nemko AS

Office address

Internet

Telephone

Fax

P.O. Box 73, Blindern

Gaustadalléen 30

www.nemko.com

+47 22 96 03 30

+ 47 22 96 05 50

N-0314 Oslo, Norway

Oslo

Enterprise number:

NO 974404532



---

Product	Plug connector
Pos. No	1
Model / Type Ref.	IS-018
Trade mark (if different from page 1)	
Rating	16A 250V AC
Principal characteristics	Plug connector for Class I equipment. Standard Sheet I. With cord H07RN-F 3G1-1.5mm <sup>2</sup> . IP20.

Factories:

Date of issue 25-08-2009



Signature

Terje Ulsrud

Certification Department

Nemko AS

Office address

Internet

Telephone

Fax

P.O. Box 73, Blindern

Gaustadalléen 30

[www.nemko.com](http://www.nemko.com)

+47 22 96 03 30

+ 47 22 96 05 50

N-0314 Oslo, Norway

Oslo

Enterprise number:

NO 974404532



# CERTIFICATE NCS/FI 28682

Our Ref. 275951-3

**Product** Plug connector  
**Type** IS-018, with cord H05VV-F 3G1,5  
 IS-018, with cord H07RN-F 3G1-1,5

**Trade mark**

**Certificate Holder /  
 Manufacturer**

**Technical information** 16 A, 250 V~, IP20

**Other information** Standard sheet I

**The product is certified  
 according to the following  
 standard(s)** EN 60320-1:2001 + A1:2007  
 EN 60320-2-2:1998

**Validity** This certificate is valid until 15 August 2019 unless the standard in question has been amended or superseded with significant changes in requirements, in which case, SGS Fimko has the right to shorten the validity of the certificate based on the legislation of the European Union. This certificate includes the right to use the FI mark under the condition that changes (if any) will be checked at SGS Fimko before the product is brought onto market and that the conditions for FI certification are met.

**Directive information** The product(s) fulfils the essential safety requirements for CE conformity marking according to the Low Voltage Directive (2006/95/EC) at the date of issue of the certificate.

**Date of issue** 15 August 2014

**SGS Fimko Ltd**

**Signature**

Sixten Lökfors  
 Project Manager



This certificate has 1 appendix



This certificate is issued by the company under its General Conditions for Certification Services accessible at <http://www.sgs.fi/en/Terms-and-Conditions.aspx>. Attention is drawn to the limitations of liability defined therein and in the Test Report here above mentioned which findings are reflected in this certificate. Any unauthorized alteration, forgery or falsification of the content or appearance of this document is unlawful and offenders may be prosecuted to the fullest extent of the law.

Appendix to Certificate: 28682

**Manufacturing site(s)**

**Additional information**

This certificate replaces previous NCS/FI Certificate No. 25198, dated 20 August 2009, due to new testing and removed one manufacturing site.

## ZEICHENGENEHMIGUNG MARKS APPROVAL

ist berechtigt, für ihr Produkt /  
*is authorized to use for their product*

**Gerätesteckdose, nicht-wiederanschließbar**  
**Connector, non-rewirable**

die hier abgebildeten markenrechtlich geschützten Zeichen  
für die ab Blatt 2 aufgeführten Typen zu benutzen /  
*the legally protected Marks as shown below for the types referred to on page 2 ff.*



Geprüft und zertifiziert nach /  
*Tested and certified according to*

DIN EN 60320-1 (VDE 0625-1):2008-05; EN 60320-1:2001 + A1:2007

VDE Prüf- und Zertifizierungsinstitut GmbH  
VDE Testing and Certification Institute  
Zertifizierungsstelle / Certification

VDE Zertifikate sind nur gültig bei Veröffentlichung unter:  
VDE certificates are valid only when published on:

Aktenzeichen: 1276300-1550-0811 / 119123  
File ref.:

Ausweis-Nr. 40020397 Blatt 1  
Certificate No. Page

Weitere Bedingungen siehe Rückseite und Folgeblätter /  
further conditions see overleaf and following pages

Offenbach, 2007-03-07  
(letzte Änderung/updated 2009-09-18 )

<http://www.vde.com/zertifikat>  
<http://www.vde.com/certificate>

Name und Sitz des Genehmigungs-Inhabers / *Name and registered seat of the Certificate holder*

Aktenzeichen / *File ref.*

1276300-1550-0811 / 119123 / FG31 / E

letzte Änderung / *updated* Datum / *Date*

2009-09-18 2007-03-07

Dieses Blatt gilt nur in Verbindung mit Blatt 1 des Zeichengenehmigungsausweises Nr. 40020397.  
*This supplement is only valid in conjunction with page 1 of the Certificate No. 40020397.*

**Gerätesteckdose, nicht-wiederanschließbar**  
**Connector, non-rewirable**

Typ(en) / *Type(s)*:

**IS-16B**

Bemessungsspannung  
*Rated voltage*

AC 250 V

Bemessungsstrom  
*Rated current*

16 A

Polzahl  
*Number of poles*

2-polig mit Schutzkontakt  
*2-pole with earthing contact*

Bauart  
*Kind of construction*

Normblatt C19  
*standard sheet C19*

Kennzeichnung der  
Fertigungsstätte(n)  
*Marking of  
manufacturingplace(s)*

30006550: "C": Songgang Town; Shenzhen; China  
30006554: "K": Kun Shan City; Jiangsu; China

Produktinformation  
*Product information*

siehe Anlage Nr. 300 + 301 + 900  
*see Appendix No. 300 + 301 + 900*

PAK

Das Produkt entspricht den Anforderungen gemäß PAK-Dokument  
ZEK 01.2-08.

PAH

*The product is in accordance with the requirements of  
PAH-document ZEK 01.2-08.*

Fortsetzung siehe Blatt 3 /  
*continued on page 3*

**VDE Prüf- und Zertifizierungsinstitut**  
**Zeichengenehmigung**

Ausweis-Nr. / Blatt /  
Certificate No. page  
40020397 3

Name und Sitz des Genehmigungs-Inhabers / *Name and registered seat of the Certificate holder*

Aktenzeichen / *File ref.*  
1276300-1550-0811 / 119123 / FG31 / E

letzte Änderung / *updated* Datum / *Date*  
2009-09-18 2007-03-07

Dieses Blatt gilt nur in Verbindung mit Blatt 1 des Zeichengenehmigungsausweises Nr. 40020397.  
*This supplement is only valid in conjunction with page 1 of the Certificate No. 40020397.*

Dieser Zeichengenehmigungs-Ausweis bildet die Grundlage für die EG-Konformitätserklärung und CE-Kennzeichnung durch den Hersteller oder dessen Bevollmächtigten und bescheinigt die Konformität mit den genannten Normen im Sinne der **EG-Niederspannungsrichtlinie 2006/95/EG**.  
*This Marks Approval is the basis for the EC Declaration of Conformity and the CE Marking by the manufacturer or his agent and shows the conformity with the said standards as defined by the EC Low-Voltage Directive 2006/95/EC.*

VDE Prüf- und Zertifizierungsinstitut GmbH  
*VDE Testing and Certification Institute*  
Fachgebiet FG31  
*Section FG31*

**VDE Prüf- und Zertifizierungsinstitut  
Zeichengenehmigung**

Ausweis-Nr. / Beiblatt /  
Certificate No. Supplement  
40020397

Name und Sitz des Genehmigungs-Inhabers / *Name and registered seat of the Certificate holder*

Aktenzeichen / *File ref.*

1276300-1550-0811 / 119123 / FG31 / E

letzte Änderung / *updated* Datum / *Date*

2009-09-18

2007-03-07

Dieses Beiblatt ist Bestandteil des Zeichengenehmigungsausweises Nr. 40020397.  
*This supplement is part of the Certificate No. 40020397.*

**Gerätesteckdose, nicht-wiederanschließbar  
Connector, non-rewirable**

**Fertigungsstätte(n)**

*Place(s) of manufacture*

Referenz/*Reference*

**30006550**

I-Sheng Mfg (Song Gang) Factory  
Tang Xiayong Road  
Songgang Town  
518105 BAOAN AREA, SHENZHEN  
Guangdong  
CHINA

Referenz/*Reference*

**30006554**

I-Sheng Electronics  
(Kunshan) Co., Ltd.  
888 Tai Shan Road  
Kunshan Development Zone  
215300 KUNSHAN CITY  
Jiangsu  
CHINA

VDE Prüf- und Zertifizierungsinstitut GmbH  
*VDE Testing and Certification Institute*  
Fachgebiet FG31  
*Section FG31*

# VDE Prüf- und Zertifizierungsinstitut

## Zeichengenehmigung

Ausweis-Nr. / Infoblatt /  
Certificate No. Info sheet  
40020397

Name und Sitz des Genehmigungs-Inhabers / *Name and registered seat of the Certificate holder*

Aktenzeichen / *File ref.*  
1276300-1550-0811 / 119123 / FG31 / E

letzte Änderung / *updated* Datum / *Date*  
2009-09-18 2007-03-07

Dieses Blatt gilt nur in Verbindung mit Blatt 1 des Zeichengenehmigungsausweises Nr. 40020397.  
*This supplement is only valid in conjunction with page 1 of the Certificate No. 40020397.*

### **Genehmigung zum Benutzen des auf Seite 1 abgebildeten markenrechtlich geschützten Zeichens des VDE:**

Grundlage für die Benutzung sind die Allgemeinen Geschäftsbedingungen (AGB) des VDE Prüf- und Zertifizierungsinstitut GmbH. Das Recht zur Benutzung erstreckt sich nur auf die bezeichnete Firma mit den genannten Fertigungsstätten und die oben aufgeführten Produkte mit den zugeordneten Bezeichnungen. Die Fertigungsstätte muss so eingerichtet sein, dass eine gleichmäßige Herstellung der geprüften und zertifizierten Ausführung gewährleistet ist.

Die Genehmigung ist so lange gültig wie die VDE-Bestimmungen gelten, die der Zertifizierung zugrunde gelegen haben, sofern sie nicht auf Grund anderer Bedingungen aus der Prüf- und Zertifizierungsordnung (PM102) zurückgezogen werden muss.

Der Gültigkeitszeitraum einer VDE-GS-Zeichengenehmigung kann auf Antrag verlängert werden. Bei gesetzlichen und / oder normativen Änderungen kann die VDE-GS-Zeichengenehmigung ihre Gültigkeit zu einem früheren als dem angegebenen Datum verlieren.

Der VDE-Zeichengenehmigungsausweis wird ausschließlich auf der ersten Seite unterzeichnet.

### ***Approval to use the legally protected Mark of the VDE as shown on the first page:***

*Basis for the use are the general terms and conditions of the VDE Testing and Certification Institute. The right to use the mark is granted only to the mentioned company with the named places of manufacture and the listed products with the related type references. The place of manufacture shall be equipped in a way that a constant manufacturing of the certified construction is assured.*

*The approval is valid as long as the VDE specifications are in force, on which the certification is based on, unless it is withdrawn according to other provisions of the Testing and Certification Procedure (PM102).*

*The validity period of a VDE-GS-Mark Approval may be prolonged on request. In case of changes in legal and / or normative requirements, the validity period of a VDE-GS-Mark Approval may be shortened.*

*The approval is solely signed on the first page*







# DEMKO CERTIFICATE

**Certificate No.** D-03629  
**Page** 1/3  
**Date of Issue** 2014-09-22

**Certificate Holder**

**Manufacturer**

**Production site**

See Page 2

**Certified Product Model** Connector, non-rewirable  
IS-16B  
**Trademark** I-SHENG

**Rated Voltage / Frequency** 250 V~  
**Rated Current / Power** 16 A  
**Insulation Class** -  
**Degree of protection (IP)** 20  
**Tested acc. to** EN 60320-1:2001/A1:2007, EN 60320-1:2001  
**Test Report No.** NCS/FI 28700 issued on 2014-08-21  
**Additional** See Page 2  
**Expire date** 2019-08-21

**Certification Manager**  
Jan-Erik Storgaard

This is to certify that representative sample(s) of the Product described herein ("Certified Product") have been investigated and found in compliance with the Standard(s) indicated on this Certificate, in accordance with the D Mark Requirements. The Designated Certificate holder is entitled to use the d or for cables <DEMKO> for the Certified Product manufactured at the production site(s) identified above, in accordance with the D Mark Service Agreement, including without limitation the D Mark Testing and Certification Services Service Terms. Only those Products bearing the D Mark should be considered as being covered by UL's D Mark Service. This Certificate shall remain valid through the expiration date, unless terminated earlier in accordance with the Service Agreement including without limitation if the Standard identified on this Certificate is amended or withdrawn prior to the expiration date.

**Certification Body**

UL International Demko A/S, Borupvang 5A, DK-2750  
Ballerup, Denmark, Tel. +45 44 85 65 65,  
info.dk@ul.com  
www.ul-europe.com



# Appendix DEMKO CERTIFICATE

**Certificate No.** D-03629  
**Page** 2/3  
**Date of Issue** 2014-09-22

Production Sites:

External Certification Information:  
NCS/FI 28700, issued on 2014-08-21 by SGS Fimko Ltd.

Additional Information:  
Standard sheet C19  
Cord H05VV-F 3G1-1,5

This certificate replaces the certificate No. 314009-02, dated 2009-12-09 due to new testing and remove one Manufacturing site.

---

**Certification Body**

UL International Demko A/S, Borupvang 5A, DK-2750  
Ballerup, Denmark, Tel. +45 44 85 65 65, info.dk@ul.com  
[www.ul-europe.com](http://www.ul-europe.com)



# Appendix DEMKO CERTIFICATE

Certificate No. D-03629  
Page 3/3  
Date of Issue 2014-09-22

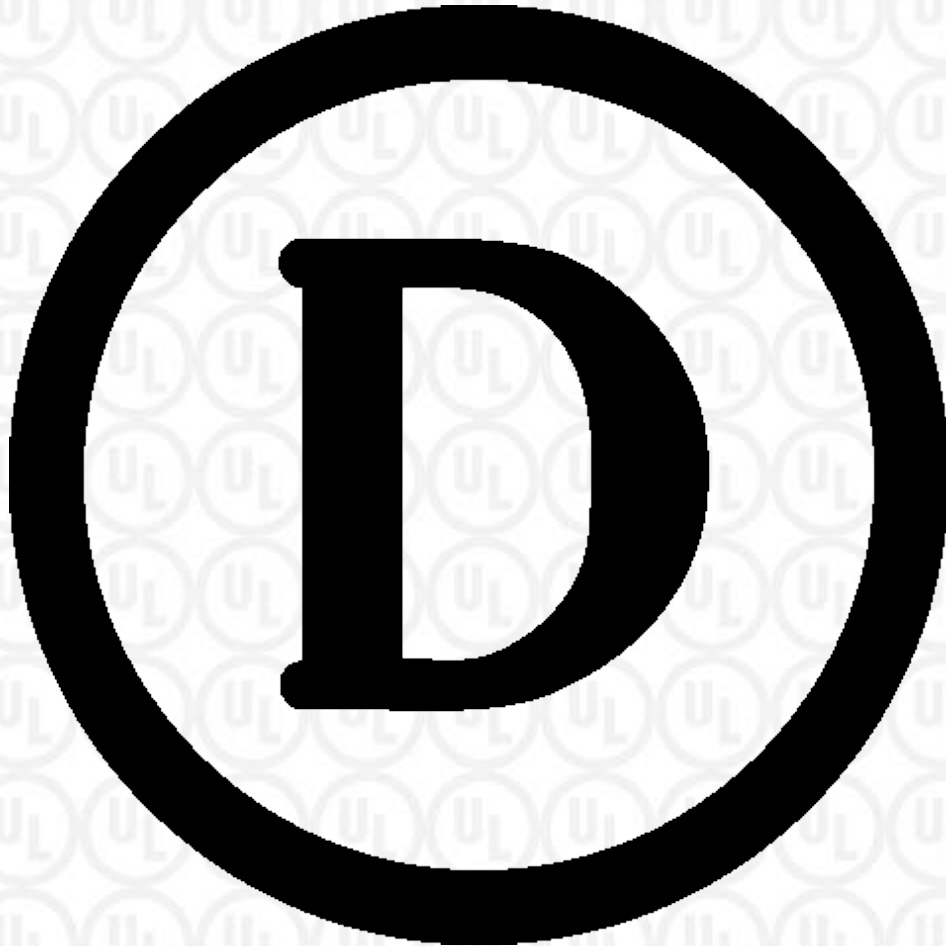

**Certification Body**

UL International Demko A/S, Borupvang 5A, DK-2750  
Ballerup, Denmark, Tel. +45 44 85 65 65, info.dk@ul.com  
www.ul-europe.com



# Certificate



for European Product Safety

Reference No. 1412115

## Connector, non-rewirable

Type designation IS-16B

Certificate holder

The product complies with the standard(s) EN 60320-1:2001 +A1

Date of expiry 15 September 2019

EU Directive information The product satisfies the provisions for CE marking according to the Low Voltage Directive 2006/95/EC.

Additional information in Appendix.

Certification Body Intertek Semko AB, Product Certification

Place Kista - Stockholm

Signed

  
Bo Berglöf

Date 15 September 2014

Page 1 of 3

This certificate is issued in accordance with the terms and conditions set out in the Appendix.



Intertek  
**Appendix**

Reference No. 1412115

*Technical data*

Type designation	IS-16B
Rated voltage (V)	250V~
Rated current (A)	16A
IP-Class	IP20
Type of cord	H05VV-F 3G1-1,5mm <sup>2</sup>
Standard sheet	C19
Design code	I-SHENG
Product information	Non-rewirable

*Manufacturing site(s)*

*This Certificate is for the exclusive use of Intertek's Client and is provided pursuant to the Certification agreement between Intertek and its Client. Intertek's responsibility and liability are limited to the terms and conditions of the agreement. Intertek assumes no liability to any party, other than to the Client in accordance with the agreement, for any loss, expense or damage occasioned by the use of this certificate. Only the Client is authorized to permit copying or distribution of this certificate and then only in its entirety. Use of Intertek's Certification mark is restricted to the conditions laid out in the agreement. Any further use of the Intertek name for the sale or advertisement of the tested material, product or service must first be approved in writing by Intertek. Initial Factory Assessments and Follow up Services are for the purpose of assuring appropriate usage of the Certification mark in accordance with the agreement, they are not for the purposes of production quality control and do not relieve the Client of their obligations in this respect.*



Intertek  
**Appendix**

Reference No. 1412115

This certificate, which includes production control, constitutes sufficient support for an EC Declaration of Conformity and CE marking, according to the principle of presumption of conformity, of the product according to the Low Voltage Directive 2006/95/EC.

This presumption can expire before end of validity of this certificate due to new issued Standard or Amendment and changes within the EU legislation.

If the product is to be marketed in different European countries, it must be provided with a certified plug appropriate for each country.

Safety related parts of the user instructions shall be written in a language acceptable to the country where the product is to be used.

This certificate replaces previously issued ref. No. 916631 dated 7 December 2009.

A new certificate has been issued on account of new testing and removed one Manufacturing site

This certificate is based on a certificate with ref. No. NCS/FI 28700 dated 21 August 2014, issued by SGS Fimko Ltd according to the Nordic Certification Service Agreement.

*Certification Body* Intertek Semko AB, Product Certification *Place* Kista - Stockholm

*Signed*

  
B6 Berglöf

*Date* 15 September 2014

*This Certificate is for the exclusive use of Intertek's Client and is provided pursuant to the Certification agreement between Intertek and its Client. Intertek's responsibility and liability are limited to the terms and conditions of the agreement. Intertek assumes no liability to any party, other than to the Client in accordance with the agreement, for any loss, expense or damage occasioned by the use of this certificate. Only the Client is authorized to permit copying or distribution of this certificate and then only in its entirety. Use of Intertek's Certification mark is restricted to the conditions laid out in the agreement. Any further use of the Intertek name for the sale or advertisement of the tested material, product or service must first be approved in writing by Intertek. Initial Factory Assessments and Follow up Services are for the purpose of assuring appropriate usage of the Certification mark in accordance with the agreement, they are not for the purposes of production quality control and do not relieve the Client of their obligations in this respect.*



Product Connector

Applicant

Manufacturer

Factory  See page 2

Ratings 16A 250V AC

Trade mark I-Sheng

Model / Type Ref. IS-16B

Principal characteristics Non-rewirable connector, with cord H05VV-F 3G1-1.5mm<sup>2</sup>.  
Standard Sheet C19. IP20  
 See next page(s)

A sample of the product was tested and found to be in conformity with INST EN 60320-1:2001;A1

Validity This certificate documents conformity with the standards shown, and also applies as license for use of Nemkos name and certification mark. The certificate and license is valid as long as the applicable conditions are complied with, and provided that any changes to the product are notified to Nemko for acceptance prior to implementation.  
New standards or amendments to the standards may imply that the product design must be updated and/or that re-testing and re-certification is necessary.

Additional information  See next page(s)

Additional model(s)  See next page(s)

Date of issue 04-12-2009



Signature

Geir Hørthe

Certification Department

Nemko AS

P.O. Box 73, Blindern

N-0314 Oslo, Norway

Office address

Gaustadalléen 30

Oslo

Internet

[www.nemko.com](http://www.nemko.com)

Telephone

+47 22 96 03 30

Enterprise number:

Fax

+ 47 22 96 05 50

NO 974404532

Factories:

Date of issue 04-12-2009



Signature

Geir Hørthe

Certification Department

Nemko AS

P.O. Box 73, Blindern

N-0314 Oslo, Norway

Office address

Gaustadalléen 30

Oslo

Internet

[www.nemko.com](http://www.nemko.com)

Telephone

+47 22 96 03 30

Enterprise number:

Fax

+ 47 22 96 05 50

NO 974404532



# CERTIFICATE NCS/FI 28700

Our Ref. 275951-7

**Product** Connector, non-rewirable  
**Type** IS-16B, with cord H05VV-F 3G1-1,5  
**Trade mark**  
**Certificate Holder/ Manufacturer**

**Technical information** 16 A, 250 V~, IP20

**Other information** Standard sheet C19

**The product is certified according to the following standard(s)** EN 60320-1:2001 + A1:2007

**Validity** This certificate is valid until 21 August 2019 unless the standard in question has been amended or superseded with significant changes in requirements, in which case, SGS Fimko has the right to shorten the validity of the certificate based on the legislation of the European Union. This certificate includes the right to use the FI mark under the condition that changes (if any) will be checked at SGS Fimko before the product is brought onto market and that the conditions for FI certification are met.

**Directive information** The product(s) fulfils the essential safety requirements for CE conformity marking according to the Low Voltage Directive (2006/95/EC) at the date of issue of the certificate.

**Date of issue** 21 August 2014

**Signature**  
  
 Sixten Lökfors  
 Project Manager



This certificate has 1 appendix



This certificate is issued by the company under its General Conditions for Certification Services accessible at <http://www.sgs.fi/en/Terms-and-Conditions.aspx>. Attention is drawn to the limitations of liability defined therein and in the Test Report here above mentioned which findings are reflected in this certificate. Any unauthorized alteration, forgery or falsification of the content or appearance of this document is unlawful and offenders may be prosecuted to the fullest extent of the law.

Appendix to Certificate: 28700

**Manufacturing site(s)**

**Additional information**

This certificate replaces certificate NCS/FI 25433 dated 25 November 2009, due to new testing and removed one Manufacturing site.