

Datasheet

RS Article: 177- 0113

DC – D Frame Solenoid 24V

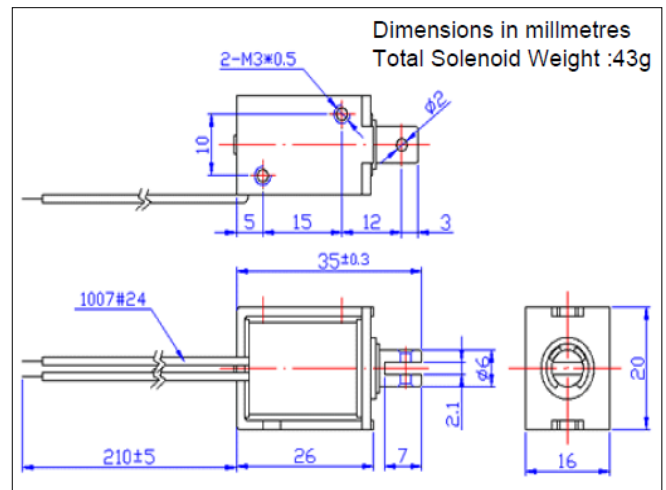

Specifications:

Features:

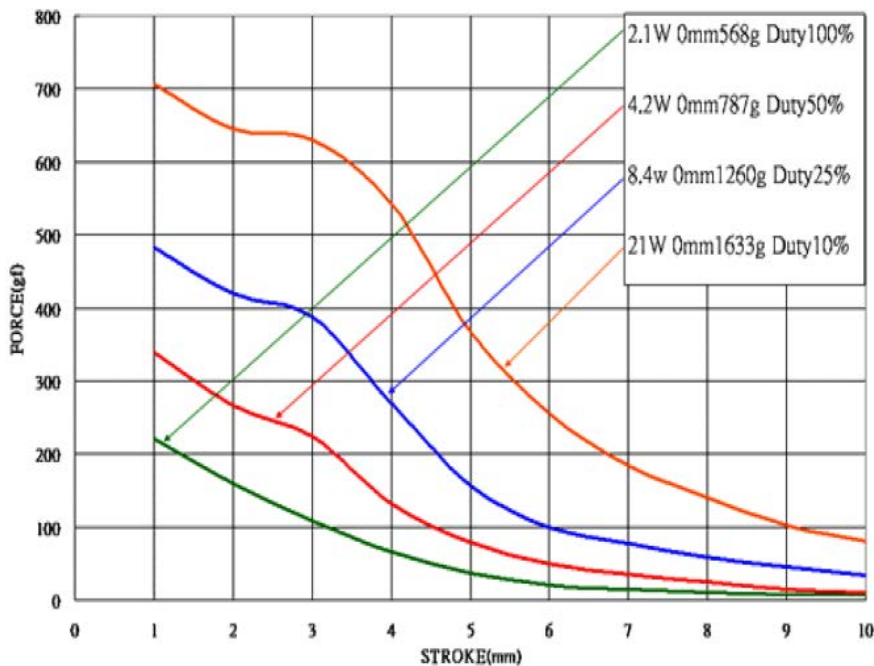

- Pull type
- Flying leads
- Corrosion resistant plated parts