

Datasheet

Mini Quarter Turn Locks

RS Stock No:146-1803

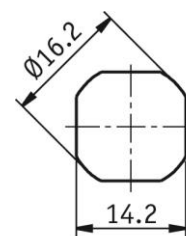
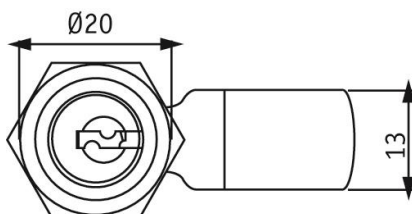

Fixing Hole

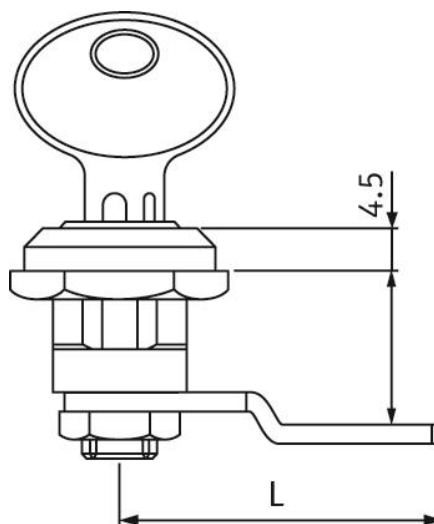

Blank dimension is
"Grip Range"

Specification

Die-cast Zinc alloy.

Chrome Plated.

Supplied with 2 euro Keys (5333).

Fixed with nut.



ENGLISH

Part Number	Type	Grip Range	L (mm)
146-1804	Nut	13	31
146-1808	Nut	16	30
146-1803	Nut	20	26

All dimensions in mm