

Datasheet

Yellow 9 way D plug w/RJ45 socket adaptor

RS Stock number 314-8234



Dimensions: (mm)

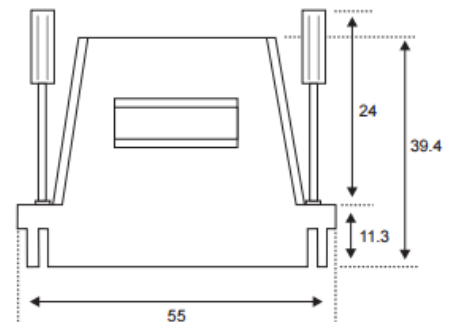
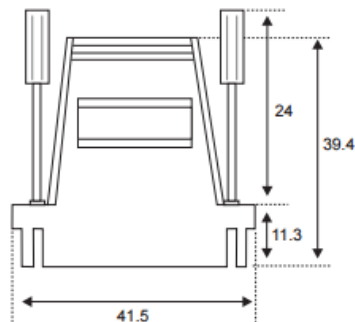
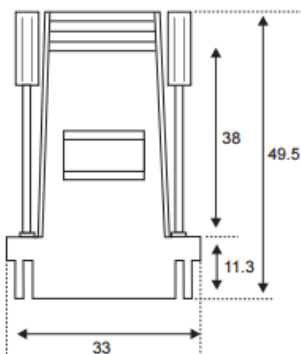

Specifications

RJ45 : Modular

Pin : Cord Colour Yellow