



ENGLISH

Datasheet

RS Pro Carbide PCB Drill Bit 0.6mm

RS Stock No: **457-645**



Product Details

RS Pro tungsten carbide drill bit has a diameter of 0.6 mm. The miniature solid drill bit has a shoulder shank for easy handling. This drill bit is suitable for PCB drilling and provides clean hole on multi layer PCB boards or standard circuit boards.

Features and Benefits

- Tungsten carbide
- Diameter of 0.6 mm
- Shoulder shank for easy handling
- Suitable for PCB drilling
- Provides clean hole on multi layer PCB boards or standard circuit boards



ENGLISH

Specifications:

Diameter	0.6 mm
Material	Carbide
Flute Length	6.5 mm
Overall Length	38 mm
Shank Diameter	3.175 mm

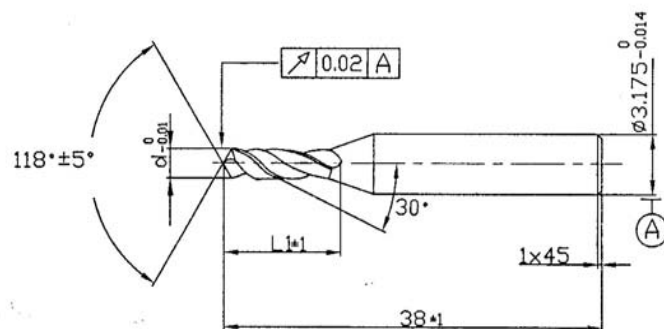

RS STOCK NUMBER	MANUFACTURE PART NO.	DESCRIPTION	DIA.(d)mm	TOLERENC E(mm)	OVERALL LENGTH(mm)	FLUTE LENGTH(L1)m m
457594	TM200-0050	Tungsten drill bit 0.5mm	0.5	-0.01	38±1	4.8±1
457645	TM200-0060	Tungsten drill bit 0.6mm	0.6	-0.01	38±1	6.5±1
457649	TM200-0070	Tungsten drill bit 0.7mm	0.7	-0.01	38±1	8.5±1
457633	TM200-0080	Tugsten drill bit0.8mm	0.8	-0.01	38±1	9.5±1
457639	TM200-0090	Tungsten drill bit 0.9mm	0.9	-0.01	38±1	9.5±1
457655	TM200-0100	Tungsten drill bit 1.0mm	1.0	-0.01	38±1	10.5±1
457623	TM200-0110	Tungsten drill bit 1.1mm	1.1	-0.01	38±1	10.5±1
457673	TM200-0120	Tungseten drill bit 1.2mm	1.2	-0.01	38±1	10.5±1
457677	TM200-0130	Tungsten drill bit 1.3mm	1.3	-0.01	38±1	10.5±1
457667	TM200-0140	Tungsten drill bit 1.4mm	1.4	-0.01	38±1	10.5±1
457661	TM200-0150	Tungsten drill bit 1.5mm	1.5	-0.01	38±1	10.5±1

Remarks:

- Material: Tungsten carbide
- Shank Dia.: 1/8"