



ENGLISH

Datasheet

ABS Instrument Case, Grey, 90 x 50 x 24mm

RS Stock number 219-548



Description:

Plastic enclosure, dark grey colour, made of heat resistant high-impact plastic UL-94V0. Provides protection against dust and moisture according to the standard IP54. Printed circuit boards may be horizontally or vertically mounted.

Specifications:

Colour:	Dark grey
Body Material:	ABS
External Dimensions:	90 (length) x 50 (width) x 24 (height)mm
IP Rating:	IP54
Possibility of installation of printed circuit boards:	Horizontally and vertically, racks and rails

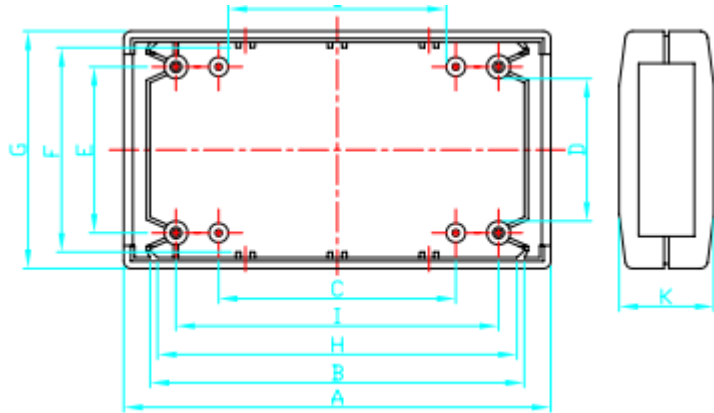
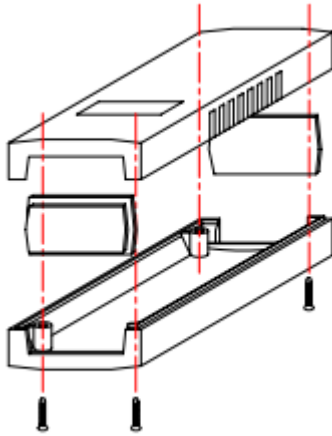

Dimensions: mm

A	90
B	83
C	50
D	27.5
E	35
F	40.5
G	50
H	79.4
I	68
J	42.5
K	24