

Evaluating the AD738x-4 Family, 4-Channel, Simultaneous Sampling, Successive Approximation ADCs

FEATURES

- ▶ Full featured evaluation board multichannel, simultaneous sampling ADC
- ▶ On-board reference, reference buffer, and ADC driver
- ▶ On-board power supplies
- ▶ Board-compatible, high-speed system demonstration platform (SDP-H1) controller
- ▶ PC software for control and data analysis

EVALUATION KIT CONTENTS

- ▶ EVAL-AD7380-4FMCZ or EVAL-AD7383-4FMCZ evaluation board
- ▶ Instructions to download software

ADDITIONAL EQUIPMENT NEEDED

- ▶ EVAL-SDP-CH1Z
- ▶ Signal source
- ▶ PC running Windows® Vista SP2 (32-bit or 64-bit), Windows 7 SP1 (32-bit or 64-bit), Windows 8.1 (32-bit or 64-bit), or Windows 10 (32-bit or 64-bit) with a USB 2.0 port

ONLINE RESOURCES

- ▶ [AD7380-4/AD7381-4/AD7383-4/AD7384-4/AD7389-4 data sheet](#)
- ▶ [ACE evaluation software](#)
- ▶ AD738x ACE plug-in
- ▶ [AD7383-4 and AD7380-4 schematic](#)
- ▶ [AD7383-4 and AD7380-4 bill of materials \(BOM\)](#)

EVALUATION BOARD CONNECTION DIAGRAM

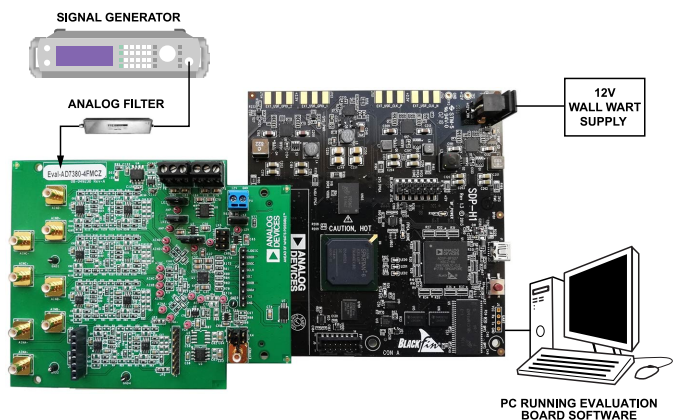

Figure 1. Typical Setup of the EVAL-AD7380-4FMCZ (Left) and the EVAL-SDP-CH1Z (Right)

GENERAL DESCRIPTION

The EVAL-AD7380-4FMCZ and EVAL-AD7383-4FMCZ are full featured evaluation boards that evaluate all features of the AD7380-4 and AD7383-4 analog-to-digital converters (ADCs). The evaluation boards can be controlled by the EVAL-SDP-CH1Z via the 160-way system demonstration platform (SDP) connector, J4. The EVAL-SDP-CH1Z board controls the evaluation boards through the USB port of a PC using the Analysis, Control, Evaluation (ACE) software, which is available for download from the [ACE software page](#).

Complete specifications for the AD7380-4, AD7381-4, AD7389-4, AD7384-4, and AD7383-4 are provided in the AD7380-4, AD7381-4, AD7389-4, AD7384-4, and AD7383-4 data sheets. Consult these specifications in conjunction with this user guide when using the evaluation boards. Full details on the EVAL-SDP-CH1Z are available on the [SDP-H1](#) product page. The comprehensive ACE user guide is available on the ACE software page.

The EVAL-AD7380-4FMCZ can be used to evaluate the AD7389-4 and AD7381-4. The EVAL-AD7383-4FMCZ can be used to evaluate the AD7384-4. 14-bit ADCs like the AD7381-4 and AD7384-4 have a lower number of SCLK cycles to clock out the conversion result. Refer to the product data sheet for information about the serial interface and for the required number of serial clock (SCLK) reading conversion results.

Figure 1 shows the typical setup of the EVAL-AD7380-4FMCZ board. The setup for the EVAL-AD7380-4FMCZ board is the same as the EVAL-AD7383-4FMCZ setup.

TABLE OF CONTENTS

Features.....	1	AD7380-4/AD7383-4 Evaluation Software	
Evaluation Kit Contents.....	1	Operation.....	10
Additional Equipment Needed.....	1	Launching the Software.....	10
Online Resources.....	1	Description of Chip View.....	12
General Description.....	1	Description of Memory Map Window.....	13
Evaluation Board Connection Diagram.....	1	Apply Changes.....	13
Evaluation Board Quick Start Guide.....	3	Apply Selected.....	13
Evaluation Board Hardware.....	4	Read All.....	13
Quad Channel AD738x-4 Family Description.....	4	Read Selected.....	13
Power Supplies.....	4	Reset Chip.....	13
Link Configuration Options.....	5	Diff.....	13
Setup Conditions.....	5	Software Defaults.....	13
Evaluation Board Circuitry.....	6	Description of Analysis Window.....	14
Evaluation Board Software.....	7	Waveform Tab.....	14
Software Installation Procedures.....	7	Capture.....	14
Warning.....	7	Results.....	14
Installing the ACE Evaluation Software.....	7	Waveform Graph.....	14
Evaluation Board Setup Procedures.....	8	Histogram Tab.....	16
Connecting the EVAL-AD7380-4FMCZ or		Results.....	17
EVAL-AD7383-4FMCZ and the EVAL-		Histogram Graph.....	17
SDP-CH1Z to a PC.....	8	FFT Tab.....	18
Verifying the Board Connection.....	8	Analysis.....	18
Disconnecting the EVAL-AD7380-4FMCZ or		Results.....	18
EVAL-AD7383-4FMCZ.....	9	Exiting the Software.....	18

REVISION HISTORY

4/2023—Revision A: Initial Version

.....

EVALUATION BOARD QUICK START GUIDE

The EVAL-AD7380-4FMCZ and EVAL-AD7383-4FMCZ are powered by the EVAL-SDP-CH1Z board by default. External power supplies can be applied. See [Table 1](#) for a description of connectors and [Table 2](#) for the link configuration required. To evaluate the AD7380-4 and AD7383-4, take the following steps:

1. Download and install the [ACE software](#), available on the [AD7380-4/AD7383-4](#) product page. Details of this installation are available on the internal label of the evaluation board box. Ensure that the EVAL-SDP-CH1Z board is disconnected from the USB port of the PC while installing the software. The PC may need to be restarted after the installation.
2. Ensure that the link options are configured as detailed in [Table 2](#).
3. Connect the EVAL-SDP-CH1Z board to the EVAL-AD7380-4FMCZ or EVAL-AD7383-4FMCZ, as shown in [Figure 2](#).
4. Connect the EVAL-SDP-CH1Z board to the PC via the USB cable. Choose to automatically search for the drivers for the EVAL-SDP-CH1Z board if prompted by the operating system.
5. Launch the ACE evaluation software from the **ACE** subfolder in the **Analog Devices** folder in the **All Programs** menu in Windows.
6. Connect an input signal to Channel A or Channel B.

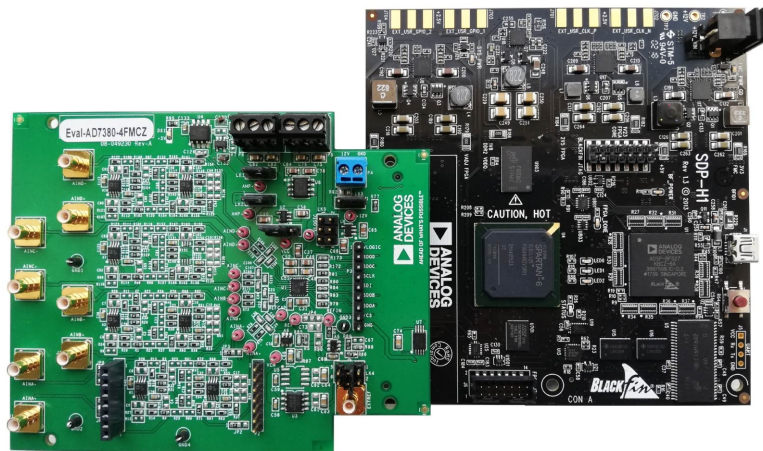

Figure 2. EVAL-AD7380-4FMCZ Board (Left) Connected to the EVAL-SDP-CH1Z Board (Right)

EVALUATION BOARD HARDWARE

QUAD CHANNEL AD738X-4 FAMILY DESCRIPTION

The 16-bit AD7380-4, AD7383-4, and AD7389-4, and the 14-bit AD7381-4 and AD7384-4 are quad, simultaneous sampling, high-speed, low power, successive approximation ADCs that operate from a 3.3 V power supply and feature throughput rates of 4 MSPS, whereas the AD7389-4 features a throughput rate of 2 MSPS. The analog input type is differential for the AD7380-4, AD7389-4, and AD7381-4. The AD7380-4, AD7381-4, and AD7389-4 can accept a wide common-mode input voltage and are sampled and converted on the falling edge of \overline{CS} . The AD7383-4 and AD7384-4 have a pseudodifferential analog input.

The AD738x-4 quad channel family of generics has an optional, integrated, on-chip oversampling blocks to improve dynamic range and reduce noise at lower bandwidths. An internal 2.5 V reference is included on the device. Alternatively, an external reference up to 3.3 V can be used.

The conversion process and data acquisition use standard control inputs, allow easy interfacing to microprocessors or digital signal

processors (DSPs). The AD738x-4 quad channel family of generics are compatible with 1.8 V, 2.5 V, and 3.3 V interfaces using the separate logic supply.

The AD738x-4 quad channel family of generics is available in a 16-lead 4 mm × 4 mm LFCSP package with operation specified from -40°C to +125°C.

POWER SUPPLIES

Ensure that all link positions are set according to the required operating mode before applying power and signals to the EVAL-AD7380-4FMCZ or EVAL-AD7383-4FMCZ. See Table 2 for the complete list of link options.

The EVAL-AD7380-4FMCZ and EVAL-AD7383-4FMCZ are powered by the EVAL-SDP-CH1Z board by default. External power supplies can be applied to the board. See Table 1 for a description of the connectors used and Table 2 for the link configurations required.

Table 1. Optional External Power Supplies

Power Supply	Connector	Voltage Range	Description
12 V	P4-1	12 V, ±10%	Main board power supply for all internal voltage regulators
GND	P4-2	0 V	Ground
V _{CC}	P5-1	3.0 V to 3.6 V	ADC analog power supply
GND	P5-2	0 V	Ground
V _{LOGIC}	P5-3	1.65 V to 3.6 V	Digital serial peripheral input power supply
AMP_PWR+	P6-1	5 V, ±5%	Amplifier positive power supply
GND	P6-2	0 V	Ground
AMP_PWR-	P6-3	-2.5 V, ±5%	Amplifier negative power supply

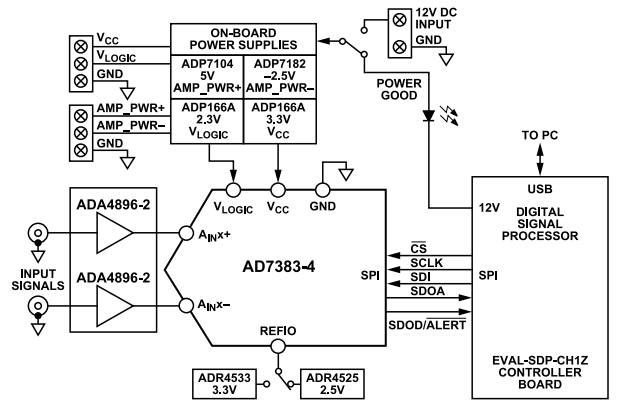

Figure 3. EVAL-AD7380-4FMCZ and EVAL-AD7383-4FMCZ Functional Block Diagram

EVALUATION BOARD HARDWARE

LINK CONFIGURATION OPTIONS

Multiple link options must be set correctly to select the appropriate operating setup before using the EVAL-AD7380-4FMCZ or EVAL-AD7383-4FMCZ. The functions of these options are detailed in [Table 2](#).

Table 2. Link Options for EVAL-AD7380-4FMCZ and EVAL-AD7383-4FMCZ

Link Name	Function	Position ¹	Description
LK1	AMP_PWR-	2	Use on-board -2.5 V from U9 for AMP_PWR-.
LK2	AMP_PWR+	2	Use on-board 5 V from U8 for AMP_PWR+.
LK3	External 12 V	1	Use 12 V power supply from SDP.
LK4	VREF	3	Use on-board +3V3 from U3 for VREF.
LK5	V _{LOGIC}	3	Use on-board 2.3 V from U6 for V _{LOGIC} .
JP1	A1NA-	1 (SMD resistor)	Connect external SubMiniature Version B (SMB) Connector J1 to the A1 buffer amplifier.
JP2	A1NA-	1 (SMD resistor)	Connect internal signal from A2 to ADC U10 Input A1NA-.
JP3	A1NA+	1 (SMD resistor)	Connect internal signal from A2 to ADC U10 Input A1NA+.
JP4	REFIO	3 (SMD resistor)	The REFIO pin is driven with the external on-board reference.
JP5	V _{CC}	1	Use internal 3.3 V from U2 for V _{CC} .
JP6	A1NA+	1 (SMD resistor)	Connect external SMB Connector J2 to the A1 buffer amplifier.

¹ SMD resistor is a surface-mount device resistor.

SETUP CONDITIONS

Ensure that all link positions are set as required by the selected operating mode before applying power and signals to the evaluation boards. [Table 2](#) shows the default positions of the links when the EVAL-AD7380-4FMCZ and EVAL-AD7383-4FMCZ are packaged.

EVALUATION BOARD HARDWARE

EVALUATION BOARD CIRCUITRY

Sockets and Connectors

The connectors and sockets on the EVAL-AD7380-4FMCZ and EVAL-AD7383-4FMCZ are described in [Table 3](#).

The default interface to this evaluation board is via the 160-way connector, which connects the EVAL-AD7380-4FMCZ and EVAL-AD7383-4FMCZ to the EVAL-SDP-CH1Z. If using the EVAL-

AD7380-4FMCZ or EVAL-AD7383-4FMCZ in standalone mode, communication is achieved via the P3 header pins.

Test Points

There are several test points and single in-line (SIL) headers on the EVAL-AD7380-4FMCZ and EVAL-AD7383-4FMCZ. These test points provide access to the signals from the evaluation board for probing, evaluation, and debugging.

Table 3. On-Board Connectors

Connector	Function
J1	Analog input
J2	Analog input
J3	Analog input
J4	Analog input
J5	Analog input
J6	Analog input
J7	Analog input
J8	Analog input
P1	Amplifier mezzanine card inputs
P2	Amplifier mezzanine card outputs
P3	Digital SPI signals
P4	Main board power supply for all internal voltage regulators
P5	ADC power supply and digital SPI power supply
P6	Amplifier power supply
P7	Field-programmable gate array (FPGA) mezzanine card (FMC) to low pin count (LPC) connector
EXT_REF	External voltage reference

EVALUATION BOARD SOFTWARE

SOFTWARE INSTALLATION PROCEDURES

Download the [ACE](#) evaluation software from the [AD7380-4](#) or [AD7383-4](#) product page and install on a PC before using the EVAL-AD7380-4FMCZ or EVAL-AD7383-4FMCZ evaluation board.

There are two steps to the installation process as follows:

1. ACE evaluation software installation
2. [EVAL-SDP-CH1Z](#) driver installation

WARNING

The evaluation board software and drivers must be installed before connecting the EVAL-AD7380-4FMCZ or EVAL-AD7383-4FMCZ and the EVAL-SDP-CH1Z to the USB port of the PC to ensure that the evaluation system is properly recognized when it is connected to the PC.

INSTALLING THE ACE EVALUATION SOFTWARE

To install the ACE evaluation software, take the following steps:

1. Download the ACE evaluation software to a Windows-based PC.
2. Double-click the **ACEInstall.exe** file to begin the installation. By default, the software is saved to the following location:
C:\Program Files (x86)\Analog Devices\ACE.
3. A dialog box appears asking for permission to allow the program to make changes to the PC. Click **Yes** to begin the installation process.
4. Click **Next >** to continue the installation, as shown in [Figure 4](#).

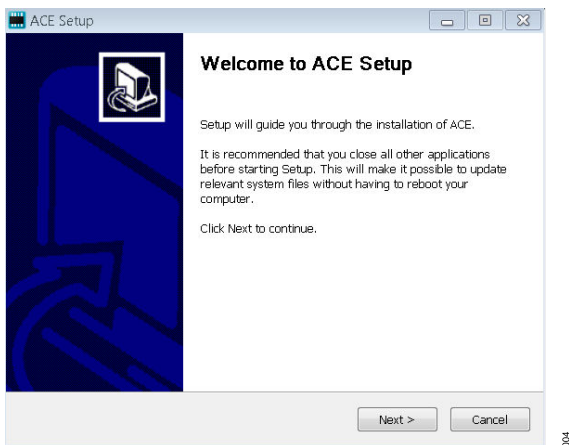

Figure 4. Evaluation Software Install Confirmation

5. Read the license and click **I Agree**.



Figure 5. License Agreement

6. Choose the install location and click **Next >**.

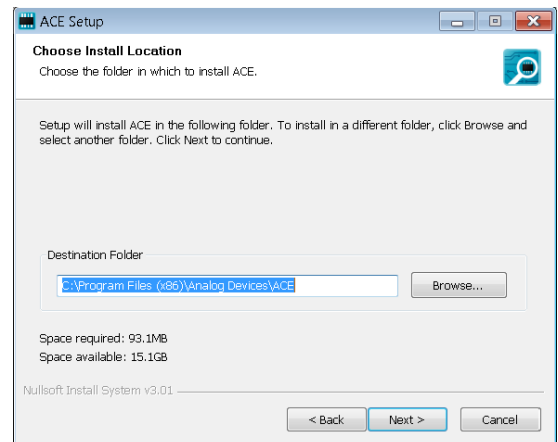

Figure 6. Choose Install Location

7. The components to install are preselected. Click **Install**.

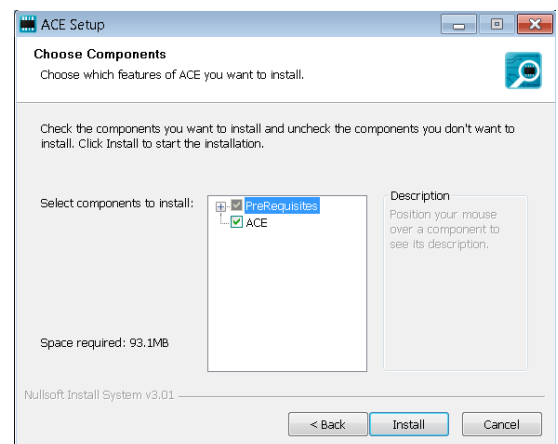

Figure 7. Choose Components

8. The **Windows Security** window appears. Click **Install**.

EVALUATION BOARD SOFTWARE

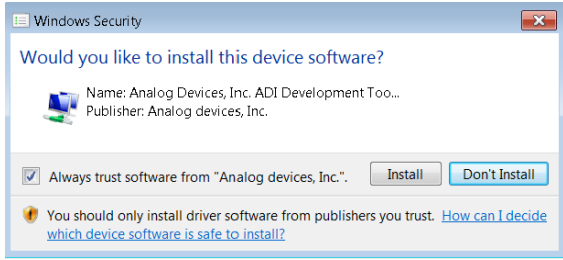

Figure 8. Windows Security Window

9. The installation is in progress. No action is required.

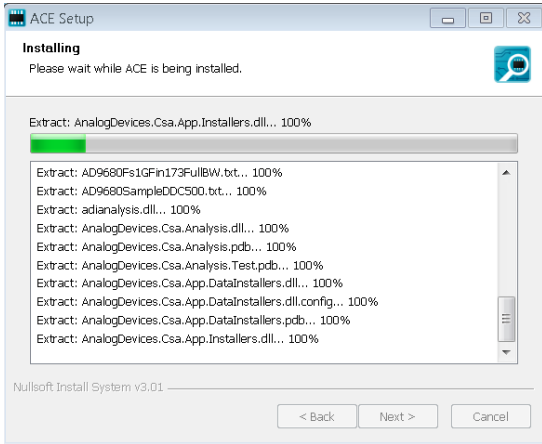

Figure 9. Installation in Progress

10. When the installation is complete, click **Next >**, and then click **Finish** to complete.

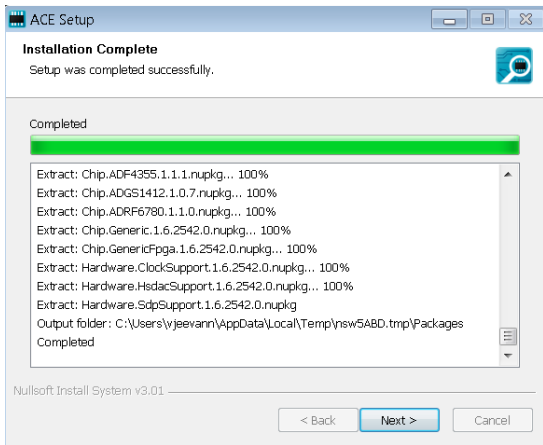

Figure 10. Installation Complete

EVALUATION BOARD SETUP PROCEDURES

The EVAL-AD7380-4FMCZ and EVAL-AD7383-4FMCZ connect to the EVAL-SDP-CH1Z. The EVAL-SDP-CH1Z is the controller board, which is the communication link between the PC and the EVAL-AD7380-4FMCZ or EVAL-AD7383-4FMCZ. Figure 2 shows a diagram of the connections between the EVAL-AD7380-4FMCZ evaluation board and the EVAL-SDP-CH1Z.

After following the instructions in the [Software Installation Procedures](#) section, set up the EVAL-AD7380-4FMCZ or EVAL-AD7383-4FMCZ and EVAL-SDP-CH1Z as detailed in the [Connecting the EVAL-AD7380-4FMCZ or EVAL-AD7383-4FMCZ and the EVAL-SDP-CH1Z to a PC](#) section.

The evaluation software and drivers must be installed before connecting the EVAL-AD7380-4FMCZ or EVAL-AD7383-4FMCZ and EVAL-SDP-CH1Z to the USB port of the PC. Installing the software and drivers prior to connection ensures that the evaluation system is correctly recognized when it is connected to the PC.

CONNECTING THE EVAL-AD7380-4FMCZ OR EVAL-AD7383-4FMCZ AND THE EVAL-SDP-CH1Z TO A PC

To connect the EVAL-AD7380-4FMCZ or the EVAL-AD7383-4FMCZ and the EVAL-SDP-CH1Z kit to a PC, follow these steps:

1. Ensure that all configuration links are in the appropriate positions, as detailed in [Table 2](#).
2. Connect the EVAL-AD7380-4FMCZ or EVAL-AD7383-4FMCZ board securely to the 160-way connector on the EVAL-SDP-CH1Z.

The EVAL-AD7380-4FMCZ and EVAL-AD7383-4FMCZ boards do not require an external power supply adapter.

3. Connect the EVAL-SDP-CH1Z board to the PC via the USB cable enclosed in the EVAL-SDP-CH1Z kit.

VERIFYING THE BOARD CONNECTION

To verify that the EVAL-SDP-CH1Z is connected properly, follow these steps:

1. Allow **Found New Hardware Wizard** to run after the EVAL-SDP-CH1Z board is plugged into the PC. Choose to automatically search for the drivers for the EVAL-SDP-CH1Z board if prompted by the operating system.
2. Confirm that the evaluation board is connected to the PC correctly using the **Device Manager** window. A dialog box may appear asking for permission to allow the program to make changes to the computer. Click **Yes**. The **Computer Management** window appears. From the list labeled **System Tools**, click **Device Manager**.
3. If the EVAL-SDP-CH1Z driver software is installed and the board is connected to the PC correctly, **Analog Devices SDP-H1** appears nested under **ADI Development Tools** in the **Device Manager** window, as shown in [Figure 11](#).

EVALUATION BOARD SOFTWARE

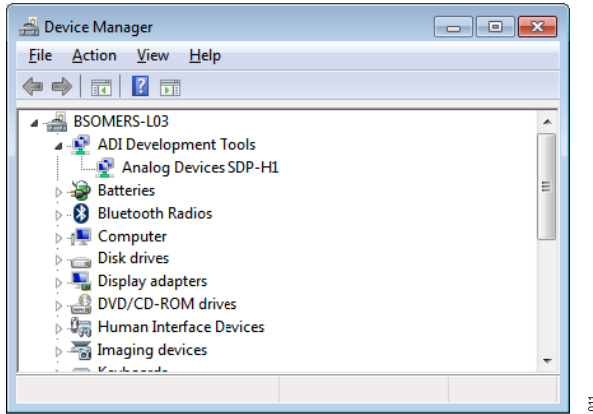

Figure 11. Device Manager Window

DISCONNECTING THE EVAL-AD7380-4FMCZ OR EVAL-AD7383-4FMCZ

Always disconnect power from the EVAL-SDP-CH1Z or press the reset tact switch located alongside the Mini-USB port before removing the EVAL-AD7380-4FMCZ or EVAL-AD7383-4FMCZ evaluation board.

AD7380-4/AD7383-4 EVALUATION SOFTWARE OPERATION

LAUNCHING THE SOFTWARE

After the EVAL-AD7380-4FMCZ or EVAL-AD7383-4FMCZ and EVAL-SDP-CH1Z boards are correctly connected to the PC, launch the ACE evaluation software.

1. From the **Start** menu, select **All Programs > Analog Devices > ACE > ACE.exe**, which brings up the window shown in [Figure 12](#).
2. If the EVAL-AD7380-4FMCZ or EVAL-AD7383-4FMCZ evaluation board is not connected to the USB port via the EVAL-SDP-CH1Z when the software is launched, the **AD7380-4**

Eval Board icon does not appear in the **Attached Hardware** section. Connect the EVAL-AD7380-4FMCZ or EVAL-AD7383-4FMCZ and the EVAL-SDP-CH1Z to the USB port of the PC and wait a few seconds, and then follow the instructions that appear in the dialogue box.

3. Double click the **AD7380-4 Eval Board** icon to view the window shown in [Figure 13](#).
4. Double click the **AD7380-4** chip icon to access the window shown in [Figure 14](#).
5. Click **Software Defaults** and then click **Apply Changes**.

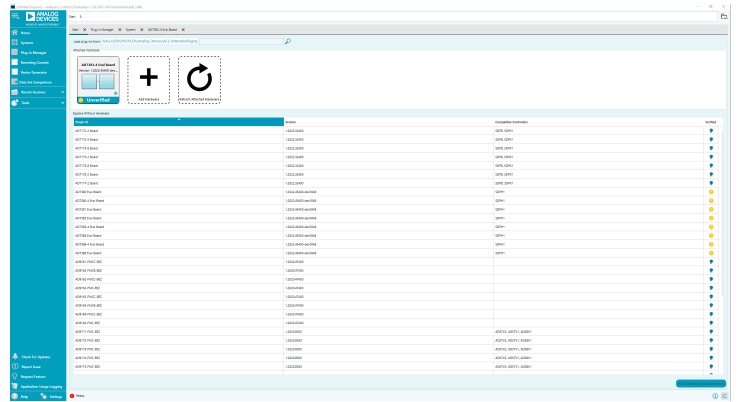

Figure 12. ACE Software Main Window

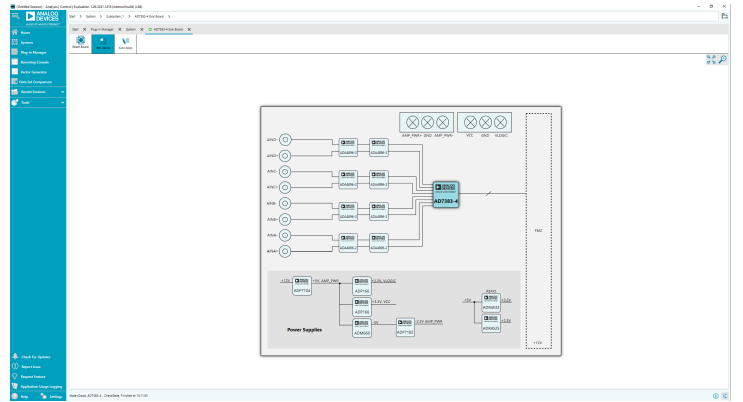

Figure 13. Board View

AD7380-4/AD7383-4 EVALUATION SOFTWARE OPERATION

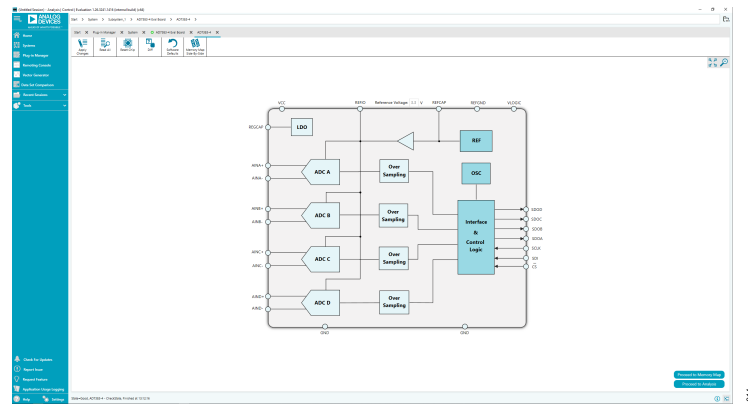

Figure 14. Chip View

AD7380-4/AD7383-4 EVALUATION SOFTWARE OPERATION

DESCRIPTION OF CHIP VIEW

After completing the steps in the [Software Installation Procedures](#) section and the [Evaluation Board Setup Procedures](#) section, set up the system for data capture.

1. Block icons that are dark blue are programmable blocks. Clicking a dark blue block icon opens a configurable pop-up window

that allows customization for the data capture, as shown in the chip view in [Figure 15](#).

2. Type the value of reference voltage in the **Reference Voltage** box when the external reference is selected. The default value for the external reference is set to 3.3 V, and 2.5 V for the internal reference.

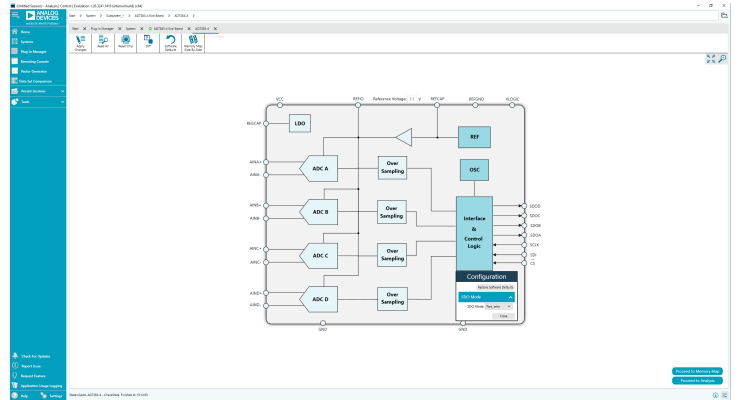

Figure 15. Pop-Up Configurable Window

AD7380-4/AD7383-4 EVALUATION SOFTWARE OPERATION

DESCRIPTION OF ANALYSIS WINDOW

Click **Proceed to Analysis** in the chip view to open the window, as shown in [Figure 17](#). The analysis view contains the **Waveform** tab, **Histogram** tab, and the fast Fourier transform (FFT) tab.

WAVEFORM TAB

The **Waveform** tab displays data in the form of time vs. discrete data values with the results, as shown in [Figure 18](#). The **CAPTURE** pane contains capture settings, which reflect into the registers automatically before data capture.

CAPTURE

General Capture Settings

The **Sample Count** list allows the user to select the number of samples per channel per capture.

The **SPI Frequency** list allows the user to select the SPI clock frequency used to transfer data between the FPGA device and the AD7380-4/AD7383-4 during device register reads and writes and during data capture. This frequency must be set relatively higher than the set throughput rate.

The user can enter the input sample frequency in kSPS in the **Sample Frequency(kspS)** box. Refer to the AD7380-4 or AD7383-4 data sheet to determine the maximum sampling frequency for the selected mode.

Device Settings

The **Over Sampling Ratio** list, when enabled, can be set between 2 and 32 and provides improved signal-to-noise ratio (SNR) performance. Refer to the AD7380-4 or AD7383-4 data sheet to determine the maximum oversampling ratio for the selected oversampling mode.

Select 18-bit resolution to enter 18-bit resolution mode. The resolution boost is used in conjunction with the oversampling rate to provide two extra bits of resolution.

The **Over Sampling Mode** list allows the user to select the mode of oversampling. This setting is only applicable when oversampling is enabled.

Run Once

Click **Run Once** to start a data capture of the samples at the sample rate specified in the **Sample Count** list. These samples are

stored on the FPGA device and are only transferred to the PC when the sample frame is complete.

Run Continuously

Click **Run Continuously** to start a data capture that gathers samples continuously with one batch of data at a time. The **Run Once** operation is run continuously.

RESULTS

Display Channels

Display channels, **Channel A**, **Channel B**, **Channel C**, and **Channel D**, allows the user to select the channels to capture. The channel data is shown only if that channel is selected before the capture.

Waveform Results

Waveform Results displays amplitude, sample frequency, and noise analysis data for the selected channels.

Export Capture Data

Click **Export** to export the captured data. The waveform, histogram, and FFT data is stored in .xml files along with the values of parameters at capture.

WAVEFORM GRAPH

The data **Waveform** graph shows each successive sample of the ADC output. The user can zoom and pan the waveform using the embedded waveform tools. The channels to display can be selected in **Display Channels**.

Display Units and Axis Controls

Click the **Display Units** dropdown list to select whether the data graph displays in units of hex, volts, or codes. The axis controls are dynamic.

When selecting either y-scale dynamic or x-scale dynamic, the corresponding axis width automatically adjusts to show the entire range of the ADC results after each batch of samples.

AD7380-4/AD7383-4 EVALUATION SOFTWARE OPERATION

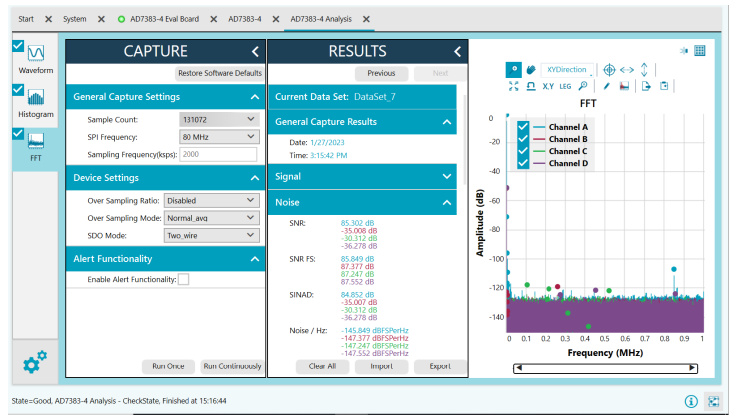

Figure 17. Analysis View

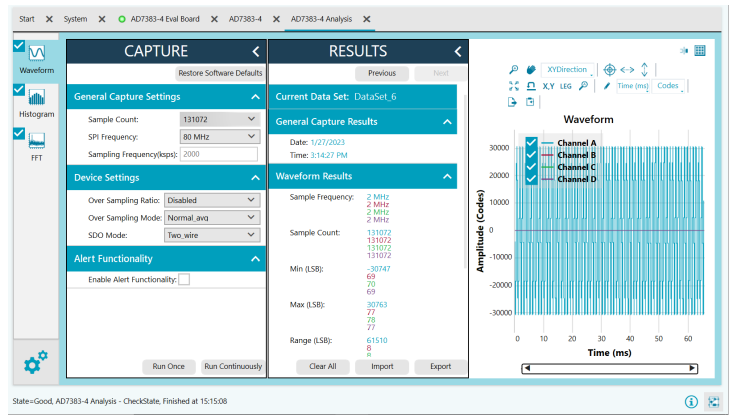

Figure 18. Waveform Tab

AD7380-4/AD7383-4 EVALUATION SOFTWARE OPERATION

HISTOGRAM TAB

The Histogram tab contains the histogram graph and the results pane, as shown in Figure 19.

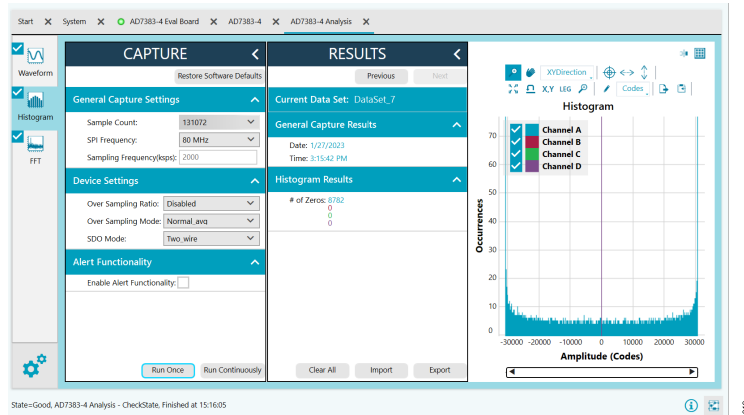

Figure 19. Histogram Tab

AD7380-4/AD7383-4 EVALUATION SOFTWARE OPERATION

RESULTS

The **RESULTS** pane displays the information related to the DC performance.

HISTOGRAM GRAPH

The **Histogram** graph displays the number of hits per code within the sampled data. This graph is useful for DC analysis, and indicates the noise performance of the device.

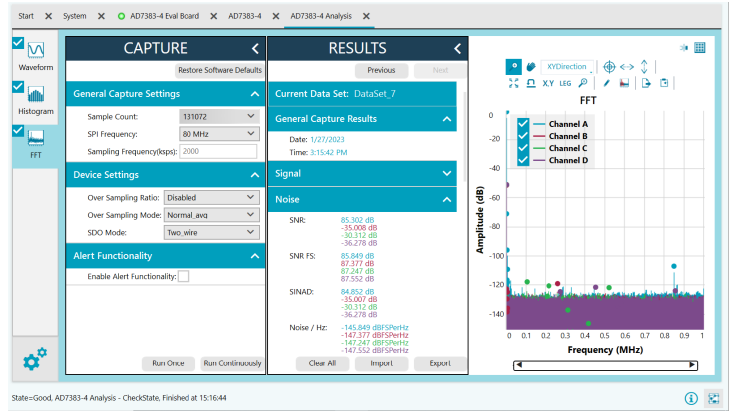

Figure 20. FFT Tab

AD7380-4/AD7383-4 EVALUATION SOFTWARE OPERATION

FFT TAB

Figure 20 shows the FFT tab, which displays FFT information for the last batch of samples gathered.

ANALYSIS

General Settings

The **General Capture Settings** pane in Figure 17 allows the user to set up the preferred configuration of the FFT analysis, including how many tones are analyzed. The fundamental is set manually.

Windowing

The windowing pane allows the user to select the windowing type used in the FFT analysis, the number of harmonic bins, and the number of fundamental bins that must be included.

Single Tone Analysis and Two Tone Analysis

The **Single Tone Analysis** and **Two Tone Analysis** panes allow the user to select the fundamental frequency included in the FFT analysis. Use **Two Tone Analysis** when there are two frequencies that must be analyzed.

RESULTS

Signal

The **Signal** pane displays the sample frequency, fundamental frequency, and fundamental power.

Noise

The **Noise** pane displays the SNR and other noise performance results.

Distortion

The distortion pane displays the harmonic content of the sampled signal and DC power when viewing the FFT analysis.

EXITING THE SOFTWARE

To exit the software, click **File** and then click **Exit**.



ESD Caution

ESD (electrostatic discharge) sensitive device. Charged devices and circuit boards can discharge without detection. Although this product features patented or proprietary protection circuitry, damage may occur on devices subjected to high energy ESD. Therefore, proper ESD precautions should be taken to avoid performance degradation or loss of functionality.

Legal Terms and Conditions

By using the evaluation board discussed herein (together with any tools, components documentation or support materials, the "Evaluation Board"), you are agreeing to be bound by the terms and conditions set forth below ("Agreement") unless you have purchased the Evaluation Board, in which case the Analog Devices Standard Terms and Conditions of Sale shall govern. Do not use the Evaluation Board until you have read and agreed to the Agreement. Your use of the Evaluation Board shall signify your acceptance of the Agreement. This Agreement is made by and between you ("Customer") and Analog Devices, Inc. ("ADI"), with its principal place of business at Subject to the terms and conditions of the Agreement, ADI hereby grants to Customer a free, limited, personal, temporary, non-exclusive, non-sublicensable, non-transferable license to use the Evaluation Board FOR EVALUATION PURPOSES ONLY. Customer understands and agrees that the Evaluation Board is provided for the sole and exclusive purpose referenced above, and agrees not to use the Evaluation Board for any other purpose. Furthermore, the license granted is expressly made subject to the following additional limitations: Customer shall not (i) rent, lease, display, sell, transfer, assign, sublicense, or distribute the Evaluation Board; and (ii) permit any Third Party to access the Evaluation Board. As used herein, the term "Third Party" includes any entity other than ADI, Customer, their employees, affiliates and in-house consultants. The Evaluation Board is NOT sold to Customer; all rights not expressly granted herein, including ownership of the Evaluation Board, are reserved by ADI. CONFIDENTIALITY. This Agreement and the Evaluation Board shall all be considered the confidential and proprietary information of ADI. Customer may not disclose or transfer any portion of the Evaluation Board to any other party for any reason. Upon discontinuation of use of the Evaluation Board or termination of this Agreement, Customer agrees to promptly return the Evaluation Board to ADI. ADDITIONAL RESTRICTIONS. Customer may not disassemble, decompile or reverse engineer chips on the Evaluation Board. Customer shall inform ADI of any occurred damages or any modifications or alterations it makes to the Evaluation Board, including but not limited to soldering or any other activity that affects the material content of the Evaluation Board. Modifications to the Evaluation Board must comply with applicable law, including but not limited to the RoHS Directive. TERMINATION. ADI may terminate this Agreement at any time upon giving written notice to Customer. Customer agrees to return to ADI the Evaluation Board at that time. LIMITATION OF LIABILITY. THE EVALUATION BOARD PROVIDED HEREUNDER IS PROVIDED "AS IS" AND ADI MAKES NO WARRANTIES OR REPRESENTATIONS OF ANY KIND WITH RESPECT TO IT. ADI SPECIFICALLY DISCLAIMS ANY REPRESENTATIONS, ENDORSEMENTS, GUARANTEES, OR WARRANTIES, EXPRESS OR IMPLIED, RELATED TO THE EVALUATION BOARD INCLUDING, BUT NOT LIMITED TO, THE IMPLIED WARRANTY OF MERCHANTABILITY, TITLE, FITNESS FOR A PARTICULAR PURPOSE OR NON-INFRINGEMENT OF INTELLECTUAL PROPERTY RIGHTS. IN NO EVENT WILL ADI AND ITS LICENSORS BE LIABLE FOR ANY INCIDENTAL, SPECIAL, INDIRECT, OR CONSEQUENTIAL DAMAGES RESULTING FROM CUSTOMER'S POSSESSION OR USE OF THE EVALUATION BOARD, INCLUDING BUT NOT LIMITED TO LOST PROFITS, DELAY COSTS, LABOR COSTS OR LOSS OF GOODWILL. ADI'S TOTAL LIABILITY FROM ANY AND ALL CAUSES SHALL BE LIMITED TO THE AMOUNT OF ONE HUNDRED US DOLLARS (\$100.00). EXPORT. Customer agrees that it will not directly or indirectly export the Evaluation Board to another country, and that it will comply with all applicable United States federal laws and regulations relating to exports. GOVERNING LAW. This Agreement shall be governed by and construed in accordance with the substantive laws of the Commonwealth of Massachusetts (excluding conflict of law rules). Any legal action regarding this Agreement will be heard in the state or federal courts having jurisdiction in Suffolk County, Massachusetts, and Customer hereby submits to the personal jurisdiction and venue of such courts. The United Nations Convention on Contracts for the International Sale of Goods shall not apply to this Agreement and is expressly disclaimed.

